



UNIVERSITAT DE  
BARCELONA

## Modelling Social-Ecological Systems in the Catalan Coastal Zones

Benjamin John Tomlinson

**ADVERTIMENT.** La consulta d'aquesta tesi queda condicionada a l'acceptació de les següents condicions d'ús: La difusió d'aquesta tesi per mitjà del servei TDX ([www.tdx.cat](http://www.tdx.cat)) i a través del Dipòsit Digital de la UB ([diposit.ub.edu](http://diposit.ub.edu)) ha estat autoritzada pels titulars dels drets de propietat intel·lectual únicament per a usos privats emmarcats en activitats d'investigació i docència. No s'autoritza la seva reproducció amb finalitats de lucre ni la seva difusió i posada a disposició des d'un lloc aliè al servei TDX ni al Dipòsit Digital de la UB. No s'autoritza la presentació del seu contingut en una finestra o marc aliè a TDX o al Dipòsit Digital de la UB (framing). Aquesta reserva de drets afecta tant al resum de presentació de la tesi com als seus continguts. En la utilització o cita de parts de la tesi és obligat indicar el nom de la persona autora.

**ADVERTENCIA.** La consulta de esta tesis queda condicionada a la aceptación de las siguientes condiciones de uso: La difusión de esta tesis por medio del servicio TDR ([www.tdx.cat](http://www.tdx.cat)) y a través del Repositorio Digital de la UB ([diposit.ub.edu](http://diposit.ub.edu)) ha sido autorizada por los titulares de los derechos de propiedad intelectual únicamente para usos privados enmarcados en actividades de investigación y docencia. No se autoriza su reproducción con finalidades de lucro ni su difusión y puesta a disposición desde un sitio ajeno al servicio TDR o al Repositorio Digital de la UB. No se autoriza la presentación de su contenido en una ventana o marco ajeno a TDR o al Repositorio Digital de la UB (framing). Esta reserva de derechos afecta tanto al resumen de presentación de la tesis como a sus contenidos. En la utilización o cita de partes de la tesis es obligado indicar el nombre de la persona autora.

**WARNING.** On having consulted this thesis you're accepting the following use conditions: Spreading this thesis by the TDX ([www.tdx.cat](http://www.tdx.cat)) service and by the UB Digital Repository ([diposit.ub.edu](http://diposit.ub.edu)) has been authorized by the titular of the intellectual property rights only for private uses placed in investigation and teaching activities. Reproduction with lucrative aims is not authorized nor its spreading and availability from a site foreign to the TDX service or to the UB Digital Repository. Introducing its content in a window or frame foreign to the TDX service or to the UB Digital Repository is not authorized (framing). Those rights affect to the presentation summary of the thesis as well as to its contents. In the using or citation of parts of the thesis it's obliged to indicate the name of the author.



UNIVERSITAT DE  
BARCELONA

Programa de doctorat: Ciències del Mar  
Departament d'Ecologia, Facultat de Biologia

Institut de Ciències del Mar  
Consejo Superior de Investigaciones Científicas

# **Modelling Social-Ecological Systems in the Catalan Coastal Zones**

**Benjamin John Tomlinson**

**2015**

Memòria presentada per Benjamin John Tomlinson per  
optar al grau de doctor per la Universitat de Barcelona

Director de tesi:  
Dr. Francesc Maynou Hernández  
Institut de Ciències del Mar (CSIC)

Tutor de tesi:  
Dr. Miquel Canals Artigas  
Universitat de Barcelona

Author contact details:  
Benjamin John Tomlinson  
[tomlinson@icm.csic.es](mailto:tomlinson@icm.csic.es)  
[thebentomlinson@gmail.com](mailto:thebentomlinson@gmail.com)  
All rights reserved

Cover design by Juan Felipe Mejía  
[juandebogota@gmail.com](mailto:juandebogota@gmail.com)  
<http://www.unomas.tv>  
<http://www.asmatik.net>

*“Remember, always, that everything you know, and everything everyone knows, is only a model. Get your model out there where it can be viewed. Invite others to challenge your assumptions and add their own.”*

Donella H. Meadows



# Contents

Acknowledgements	ix
List of figures	xi
List of tables	xiii
List of acronyms	xiv
Abstract	xv
1 Introduction	1
1.1 Ecological impacts in the coastal zone	1
1.2 Managing ecological impacts in the coastal zone	5
1.3 Integrated assessment modelling	6
1.4 The Systems Approach Framework	15
1.4.1 ExtendSim	25
1.5 Structure and objective of thesis	27
1.6 Description of study zone	28
1.6.1 The Catalan coastal zone	28
1.6.2 Barcelona	31
2 Application 1 (SPICOSA Project) – Beach water quality and beach users	33
2.1 Background and context of the SPICOSA project	33
2.2 Issue Identification	34
2.3 System Design	37
2.4 System Formulation	41
2.4.1 Principal drivers sub-model	42
2.4.1.1 Combined sewer overflow sub-model	43
2.4.2 Beach water clarity sub-model	44
2.4.2.1 Optimising unknown parameters in Beach water clarity sub-model	46
2.4.3 Beach water bacteria sub-model	48
2.4.4 Beach users sub-model	50
2.4.5 Economic evaluation sub-model	52
2.4.5.1 Revenues of beach bars and restaurants	53
2.4.5.2 Travel-cost method	54

2.5	System Appraisal	56
2.5.1	Principal drivers sub-model	56
2.5.2	Beach water clarity sub-model	57
2.5.3	Beach water bacteria sub-model	60
2.5.4	Beach users sub-model	63
2.5.5	Economic evaluation sub-model	66
2.6	System Output	68
2.6.1	Scenario analysis	68
2.6.2	Sensitivity of output to changes in river flow and rain	72
2.6.3	Presentation to stakeholders	73
2.6.3.1	Presentation to Catalan Water Agency	74
2.6.3.2	Presentation to Commission of Coastal Affairs	75
2.7	Discussion	77
2.7.1	Discussion of the model	77
2.7.2	Discussion of the SAF application	80
3	Application 2 (VECTORS project) – Jellyfish, fisheries and beach users	83
3.1	Background and context of the VECTORS project	83
3.2	Issue Identification	85
3.3	System Design	87
3.4	System Formulation	90
3.4.1	Fisheries sub-model	90
3.4.1.1	Review of available fisheries models	90
3.4.1.1.1	Minimally realistic models	91
3.4.1.1.2	Ecosystem models	92
3.4.1.2	Selection of fisheries sub-model	94
3.4.1.3	Fisheries sub-model description	97
3.4.2	Jellyfish sub-model	102
3.4.2.1	Review of available jellyfish models	102
3.4.2.2	Selection of jellyfish sub-model	105
3.4.2.3	Jellyfish sub-model description	105
3.4.3	Stranding Sub-model	111
3.4.3.1	Review of stranding models	111
3.4.3.2	Stranding model description	112

3.4.4	Local economy sub-model	114
3.4.4.1	Review of local economy models	114
3.4.4.2	Description of local economy sub-model	116
3.5	System Appraisal	118
3.5.1	Fisheries sub-model	118
3.5.2	Jellyfish sub-model	125
3.5.3	Stranding sub-model	127
3.5.4	Local economy sub-model	128
3.6	System Output	128
3.6.1	Scenario analysis - fisheries	130
3.6.2	Scenario analysis – stranding events	132
3.6.3	Scenario analysis – local economy	134
3.6.4	Sensitivity analysis of key variables	135
3.7	Discussion	137
3.7.1	Discussion of the model	138
3.7.2	Discussion of the SAF application	141
4	Discussion	145
4.1	Comparison of the SAF applications in the SPICOSA and VECTORS projects	145
4.2	Comparison with other SAF applications and IAMs in coastal systems	153
4.3	Resilience adaptive management	156
4.4	The future of the Systems Approach Framework	159
5	Conclusions	163
6	Appendices	167
Appendix I:	Constructing a SAF model	167
Appendix II:	Summary of policy issues in the 18 study sites of the SPICOSA project	169
Appendix III:	Inputs for SPICOSA model, units, and source	170
Appendix IV:	Scenario options of SPICOSA model	174
Appendix V:	Definition of symbols, and units for SPICOSA model	175
Appendix VI:	River wind function (SPICOSA)	178
Appendix VII:	Calculation of suspended solid caused by waves (SPICOSA)	179



Appendix VIII: Solar intensity for Barcelona (SPICOSA)	182
Appendix IX: Screenshots of the model presented to stakeholders (SPICOSA)	183
Appendix X: Definition of symbols, and units for fisheries sub-model (VECTORS)	185
Appendix XI: Input values for fisheries sub-model (VECTORS)	187
Appendix XII: Estimation of parameters for <i>P. noctiluca</i> projection matrix (VECTORS)	194
Appendix XIII: Published papers	199
7 References	243

## Acknowledgements

The process involved in researching and writing a PhD thesis is long and tiring, but incredibly rewarding. I feel privileged that I have had the opportunity to learn from some of the best researchers in the world across many disciplines. When I started working at the Institut de Ciències del Mar (CSIC), Barcelona I was unsure what to expect. The level of expertise and professionalism was intimidating, but I soon realised that everyone there had time to make me feel welcome and part of the team, and inspired me to take on new challenges with confidence. I have learnt so much over the last few years that it would take too long to name everything but some skills and techniques in which I now feel confident include: liaising with researchers from diverse disciplines; researching scientific and technical literature; learning and applying modelling and analytical techniques and statistical software; and writing and presenting scientific research. None of this would have been possible without the support of many people.

First of all, I would like to express my huge gratitude to Francesc Maynou, without whom this PhD thesis would not have been possible. He patiently guided me in researching and writing this thesis along every step, always making time for my endless questions and doubts. Given the multidisciplinary nature of this research, I was fortunate to learn from many others at the Institut de Ciències del Mar, all of whom provided their time and expertise in helping me. I would like to thank the following: Dolors Blasco, Antonio Canepa, Montse Demestre, Marta Estrada, Verónica Fuentes, Jorge Guillén, Elena Ojeda, Albert Palanques, Estela Romero, Ana Sabatés, Sergio Sastre, and Uxue Tilves Matheu. I would also like to thank the administration team from the Institut de Ciències del Mar especially: Núria Angosto, Conchita Borrueal, Jordi Estaña, and Eva López.

The research in this thesis was undertaken during two European Commission projects, in which I had the opportunity to meet and learn from researchers from many countries and disciplines. This experience was intellectually challenging and rewarding and would like to thank the following for sharing their knowledge and time with me: Melanie Austen, Cedric Bacher, Denis Bailly, Johanna Balle-Beganton, Carmela Caroppo, Simona Dalla Riva, Mike Elliott, Jean-Luc de Kok, Maria Ferreira, Thomas Hopkins, Michel Lample, Joachim Maes, Anne Mette, Alice Newton, Paulo Nunes, Rafael Sardá, Josianne Støttrup, Paul Tett, Leyla Tolun, and Bert van Eck.

I would also like to thank those at the Universitat de Barcelona who continually helped me with administrative questions regarding the PhD programme, especially Antoni Calafat, Miquel Canals, and Rut Pedrosa.

This PhD thesis would have been impossible without the participation of many institutions and organisations including: Consejo Superior de Investigaciones Científicas, Universitat de Barcelona, the European Commission, and Agència Catalana de l'Aigua.

I would also like to express my gratitude to the defence committee members and the anonymous reviewers for their time and effort in evaluating this thesis.

The research in this thesis was made possible by funding made available through the European Commission's Sixth Framework Programme (FP6 2002–2006) for the project "Science and Policy Integration for Coastal System Assessment" (SPICOSA) – project reference 036992; the EC's Seventh Framework Programme (FP7-KBBE, 2007–2013) for the project "Vectors of Change in Oceans and Seas Marine Life, Impact on Economic Sectors" (VECTORS) - project reference 266445; the European Union ENPI CBC Mediterranean Sea Basin Programme for the project MED-JELLYRISK – project reference I-A/1.3/098; and the Spanish projects PUDEM (REN2003-06637-C02-01/MAR) and FISHJELLY (MAR-CTM2010-18875).

Finally, I would like to thank my wife Liliana, and family Mum, Dad, Sam and Wendy for the inspiration, support and encouragement they have given me throughout my life and during this PhD. I am also grateful to Juan Felipe Mejía for his help in designing the cover.

## List of figures

1. Decision tree used for choosing appropriate type of model in IAM	10
2. Causal loop diagram of a simple predator-prey ecosystem	12
3. The five steps of a SAF application	20
4. Example ExtendSim predator-prey model	26
5. Map of Catalonia indicating principal rivers and urban areas	29
6. Institutional map of legislation relevant to Barcelona	35
7. Initial conceptual model of the <i>identified issue</i> in the SPICOSA application	38
8. Map of the Barcelona beaches affected by combined sewer overflows and by the River Besòs	39
9. Position of the stormwater collectors in Barcelona	40
10. Redesigned conceptual model in the SPICOSA application	42
11. Annual CSO runoff depending on stormwater collector capacity and direct runoff	57
12. Suspended solids, model vs data (Hospital del Mar)	58
13. Percentage of observed turbidity ratings per beach	59
14. Model output and observed faecal coliforms	61
15. Correlation between observed data and modelled faecal	62
16. Guillén et al. model for daily beach users at Nova Icaria and Hospital del Mar	63
17. Number of beach users when effect on recreational appeal is zero.	64
18. Effect of beach closure (bacteria) and turbidity on recreational appeal	66
19. Daily revenues of restaurants, restaurant-bars and bars	67
20. Impact on “bacteria limit exceeded” and “turbid” bathing days for various stormwater collector scenarios	69
21. Wastewater treatment plant scenarios	70
22. Sensitivity analysis of the river and rain on bacteria and water clarity	72
23. Tourism and fisheries revenues, Catalonia	86
24. Catches by species, Catalonia	86
25. Observations of jellyfish by species and location in Catalonia	88
26. Conceptual model of VECTORS application model	89
27. Map of the three zones defined in VECTORS application model	89
28. Recruitment model for MEFISTO and fisheries sub-model	96
29. Graphical representation of <i>P. noctiluca</i> matrix model	103
30. Projection matrix of the <i>P. noctiluca</i> matrix model	104
31. Projection matrices with coefficients for each season	104
32. Population dynamics of <i>P. noctiluca</i> ephyra and mature adults from the Malej & Malej (1992) model	106
33. Graphical representation of <i>P. noctiluca</i> matrix model	107
34. Projection Matrix of the <i>P. noctiluca</i> matrix model	107
35. Projection Matrix with parameters	108
36. <i>P. noctiluca</i> stranding vs weekly wind	112
37. Catches of red shrimp in Barcelona MEFISTO model and fisheries sub-model	119
38. Sardine and Anchovy SSB for Catalonia – model vs data approximated from GSA06	120
39. Anchovy and sardine catches – model vs data	121
40. Anchovy and sardine revenues – model vs data	122
41. Anchovy and sardine abundance per 10m <sup>2</sup> . Model vs data taken from Sabatés (1990) and Olivar et al. (2003)	123
42. Monthly SSB, catches and revenues for anchovy and sardine in each zone	124
43. Concentration of <i>P. noctiluca</i> for each class in population matrix model	126
44. Comparison of model against data for concentration of <i>P. noctiluca</i>	127
45. Summer stranding events for adult <i>P. noctiluca</i>	127

46. Jellyfish sightings per beach observation	128
47. <i>P. noctiluca</i> blooms for each scenario	129
48. Impact of changes in <i>P. noctiluca</i> blooms on anchovy SSB, catches and revenues	131
49. Yearly profits of anchovy and sardines fisheries for Catalonia in each of the three scenarios	132
50. Sensitivity of predation rate of <i>P. noctiluca</i> ephyra on anchovy larva	136
51. Effect of <i>P. noctiluca</i> predation rate on sardine SSB	137
52. Comparison of SPICOSA and VECTORS application	145
53. Causal loop diagram of mussel predation on phytoplankton	167
54. Conceptual model of mussel predation on phytoplankton	168
55. River wind function	178
56. Example screenshots of model in ExtendSim	183
57. Monthly immature and mature <i>P. noctiluca</i> as a percentage of annual total (adapted from Rosa et al. (2013))	194
58. Converting data taken from Rose et al. (2013) to hypothetical population	195
59. Time series data used to parameterise population matrix model	196

## List of tables

1. Direct and indirect drivers of change in coastal ecosystems ecosystems	4
2. List of stakeholders that participated during SAF application	36
3. Prediction accuracy of beach water clarity sub-model (qualitative data)	59
4. Impact of river on beach water turbidity	60
5. Impact of the river on beach water bacteria	63
6. Stormwater collector scenarios	71
7. Concentration of <i>P. noctiluca</i> for each zone	108
8. Expected adults in June and Initial population of “dummy” <i>P. noctiluca</i>	109
9. Feeding rate of <i>P. noctiluca</i> ephyra.	110
10. <i>P. noctiluca</i> summer strandings 2007-2010	113
11. Stranding rate of <i>P. noctiluca</i> per coastal water population	113
12. Tourism and fisheries multipliers of the input-output model	117
13. Expected annual anchovy catches and revenues for each scenario	130
14. Percent change in annual anchovy catches and revenues relative to <i>Expected blooms</i>	131
15. Average <i>P. noctiluca</i> stranding events per month	133
16. Average <i>P. noctiluca</i> stranding events per year	134
17. Effect of <i>No blooms</i> and <i>Frequent blooms</i> scenarios on local economy, compared to <i>Expected blooms</i>	135
18. Summary of policy issues in the 18 study sites of the SPICOSA project	169
19. Inputs for SPICOSA model, units, and source	170
20. Scenario options of SPICOSA model	174
21. Definition of symbols, and units for <i>Principal drivers sub-model</i> (SPICOSA)	175
22. Definition of symbols, and units for Beach water clarity sub-model (SPICOSA)	175
23. Definition of symbols, and units for Beach water bacteria sub-model (SPICOSA)	176
24. Definition of symbols, and units for <i>Beach users sub-model</i> (SPICOSA)	177
25. Definition of symbols, and units for <i>Economic evaluation sub-model</i> (SPICOSA)	177
26. Solar intensity per hour and month for Barcelona (SPICOSA)	182
27. Definition of symbols, and units for fisheries sub-model (VECTORS)	185
28. Biological fish-growth parameters for sardine and anchovy (VECTORS)	187
29. Percent of catches of GSA06 in each zone by species (VECTORS)	187
30. Fecundity rate of anchovy taken (VECTORS)	188
31. Anchovy maturity, natural mortality, fishing mortality, fecundity and initial population per zone (VECTORS)	189
32. Sardine maturity, natural mortality, fishing mortality, fecundity and initial population per zone (VECTORS)	190
33. Fecundity modifier for anchovy and sardine (VECTORS)	192
34. Vessel, fleet and market input parameters (VECTORS)	193
35. Percentage of immature and mature <i>P. noctiluca</i> per month (VECTORS)	194

## List of acronyms

ABM	Agent-based model
ACA	Agència Catalana de l'Aigua (Catalan water agency)
AM	Adaptive management
AMB	Àrea Metropolitana de Barcelona (Metropolitan Area of Barcelona)
BFA	Blue Flag Award
BIDE	Birth Immigration Death Emigration population model
BN	Bayesian network
BORMICON	Boreal Migration and Consumption model
CCM	Coupled component model
CLABSA	Clavegueram de Barcelona, Societed Anónima (Sewerage of Barcelona)
CSO	Combined sewer overflow
EIA	Economic impact analysis
EwE	Ecopath with Ecosim
ERSEM	European Regional Seas Ecosystem Model
GADGET	Globally applicable Area Disaggregated General Ecosystem Toolbox
GRDP	Gross regional domestic product
GSA06	Northern Spain Geographical Sub-Area
GST	General Systems Theory
I/O model	Input-output model
IA	Integrated Assessment
IAM	Integrated Assessment Modelling
ICZM	Integrated Coastal Zone Management
IDESCAT	Institut d'Estadística de Catalunya (Statistical Institute of Catalonia)
INE	Instituto Nacional de Estadística (Spanish Statistical Office)
KBM	Knowledge-based model
MRRM	Minimally realistic model
MSVPA and MSFOR	Multi-species Virtual Population Analysis and Multi-species Forecasting Model
MULTISPEC	Multi-species model for the Barents Sea
OSMOSE	Object-oriented Simulator of Marine ecosystem Exploitation
SAF	Systems Approach Framework
SD	System dynamics
SEAPODYM	Spatial Ecosystem and Population Dynamics Model
SMOM	Spatial Multi-species Operating Model
SNA	System of national Accounts
SPI	Science-policy interface
SPICOSA	Science and Policy Integration for Coastal System Assessment
SSB	Spawning stock biomass
TCM	Travel cost method
VECTORS	Vectors of Change in Oceans and Seas Marine Life, Impact on Economic Sectors
WWTP	Wastewater treatment plant

## Abstract

The Systems Approach Framework (SAF) is a methodological framework designed to enhance the efficacy of human decision-making processes within social-ecological systems with regard to sustainability. The SAF attempts to create a balance between General Systems and Soft Systems Methodologies by both modelling complex systems and creating a science-policy interface. Recognising the importance of the social process is crucial to the success of any management framework, thus combining the two methodologies can improve the possibility of sustainable social-ecological systems.

The Systems Approach Framework was applied in two case studies in the coastal zone of Catalonia, in two separate European Commission Framework Programme projects entitled "Science and Policy Integration for Coastal System Assessment" (SPICOSA) and "Vectors of Change in Oceans and Seas-marine Life, Impact on Economic Sectors" (VECTORS). The overall methodological framework applied in each case study was originally intended to follow the SAF guidelines as closely as possible, but this met with varying degrees of success.

During the SPICOSA application, stakeholders were invited to discuss issues related to ecological impacts in the coastal zone of Barcelona, Spain. A common issue of interest to most stakeholders was the water quality (harmful bacteria and water clarity) of the local city beaches, particularly following combined sewer overflow events, and mitigating this impact by using stormwater collectors. Water quality influences the beach users' decision whether to stay at the beach or to leave, thus affecting the revenue received by the bars and restaurants on the beach front.

A model was constructed using the methodology outlined in the SAF to represent this issue, including ecologic, economic and social components. The idea of the model is to capture the basic functioning of the whole social-ecosystem, so that it can be used as a tool for deliberation between the stakeholders. The primary indicators of the model are: water clarity (both qualitative - "Transparent", "Turbid" and "Very turbid"; and quantitative - suspended solids  $\text{kg m}^{-3}$ ); bacteria (faecal coliforms - coliform forming units (cfu)  $100 \text{ mL}^{-1}$ ); revenues of local businesses (Euro per year); number of beach users (Individuals per year); and the recreation and aesthetic value of beach using the travel cost method (€ per year). The principal management option within the model is to increase stormwater collector capacity to reduce untreated waste entering the coastal waters.



The model output implies that the stormwater collectors have been useful in improving beach water quality in Barcelona, but there will be diminished returns in constructing more. The value of the beach is clearly large in terms of both non-market value and revenues generated in the nearby bars and restaurants. However, the impact changes in water quality would have on the recreational appeal of the beach is estimated to be low but further research is recommended to determine beach users' sensitivity to beach closures (bacteria limit exceeded) and turbidity.

At the beginning of the VECTORS project, stakeholders who had participated during the previous SAF application expressed a lack of willingness to engage due to a lack of human resources. The scientific team therefore chose to continue the application with the aspiration of demonstrating the SAF model and results at a later date if the stakeholders found the required resources to engage with the process. There is a general perception that jellyfish abundances are increasing along the Catalan coast. Local authorities are concerned about the stranding events and arrivals of jellyfish to beaches and believe it could reduce the recreational appeal of the beaches. Previous studies also demonstrate the predation of jellyfish (*Pelagia noctiluca* ephyrae) upon some small pelagic fish larvae (*Engraulis encrasicolus*). Small pelagics are the principal source of revenue for the local fisheries. A social-ecological model was created in order to capture the effects of changes in abundance of *Pelagia noctiluca* upon the local fisheries, the tourist industry and the wider economy.

Various future scenarios for different abundances of jellyfish blooms were run. Given the changes that these scenarios would cause on the regional gross domestic product and employment, this study concludes that the overall impact of either of these scenarios on the economy would not be significant at the regional scale.

The greatest limitation of the SAF is convincing the relevant stakeholders and institutions to participate in the process. They can be reluctant to do so, partly because they might not perceive any benefit in doing so, or because they do not have the necessary time and personnel resources to do so. The inclusion of stakeholders in the SAF methodology is rightly fundamental, but in practice, it can be extremely difficult to persuade key stakeholders to participate, and this is a flaw in the SAF which needs addressing. SAF Application model builders are dependent on stakeholders sharing important data or knowledge but this may be withheld for a variety of reasons including, but not limited to, lack of resources to participate, disinterest, or concern about how the results will be used.

The SAF is a well-structured methodology for cases where a mathematical model is both relevant and feasible with regards to both knowledge of the functioning of each component of the social-ecological system and the availability of data, resources, and personnel. The SAF should be considered as a useful step-by-step guide for managing coastal zone systems towards sustainability.



# 1 Introduction

## 1.1 Ecological impacts in the coastal zone

Humans have had an undeniable impact on their environment for millennia. From the time of the industrial revolution there has been an exponential increase in population combined with a steady increase in resource use per capita in terms of both energy and biomass. There has also been a simultaneous increase in the production of anthropogenic pollution which has hindered the productive capacity of previously fertile ecosystems and biodiversity. A few of these drivers include deforestation, urbanisation, agricultural development such as intensive farming, overfishing, mining, freshwater depletion, consumerism, and worldwide transport of goods and people (through migration and tourism). Some of the impacts of these drivers include, but is not limited to, species extinction, invasive species, eutrophication, desertification, climate change and various forms of land, water and air pollution. Indeed, such has been the impact of human activities on their environment that many researchers have suggested that the current geographical epoch should be given the term “Anthropocene” (Crutzen 2002, Ehlers and Krafft 2006, Zalasiewicz et al. 2011).

Even though these impacts are acknowledged by the public, scientists and governing authorities alike, the frequency and intensity of these impacts are accelerating. The Millennium Ecosystem Assessment concludes that over the past 50 years, humans have altered the planet’s ecosystems to such an extent never before seen in our history with over 60% of the ecosystem services examined being degraded or unsustainably depleted, resulting in substantial and irreversible loss in biodiversity (Millennium Ecosystem Assessment 2005a). Other key findings from this report also state that the gains in human well-being and economic development have been made at the expense of some ecosystem services and could result in non-linear changes in the future, most likely exacerbating the problems of those already living in poverty. Any small gains that these vulnerable groups might have benefitted from due to increased economic development could be wiped out by further degradation to the ecosystems in which they reside and rely upon (Millennium Ecosystem Assessment 2005a).

Although many social-ecological systems suffer from these impacts, coastal systems are particularly vulnerable to these changes due to a combination of pressures. The coastal zone is here defined as the area both within 100km of the coast up to a maximum elevation of 100m. Although there is no

universally accepted definition for the “coastal zone”, this same criteria (Small and Nicholls 2003) was also adopted by in the Millennium Ecosystem Assessment (Millennium Ecosystem Assessment 2005b) and by the International Panel for Climate Change (Nicholls et al. 2007).

The ecological importance of coastal systems is reflected in its productivity accounting for more than 25% of global net primary production and 90-95% of the world’s fisheries landings (Millennium Ecosystem Assessment 2005b). Other significant ecosystem services provided include carbonate production (80% of global total), denitrification (50% of global total), sedimentary mineralization (90% of global total), atmospheric and climate regulation, flood and storm protection, erosion control, and cultural, amenity, recreational and aesthetic services (Millennium Ecosystem Assessment 2005b). Research by Costanza et al. (1998) estimated the monetary value of the coastal zones’ ecosystems services to be 43% of the global total, whilst only covering 8% of the world’s surface.

There has been a steady migration towards the coastal zone, where there currently lives 17% of the global population on only 5% of the earth’s total land area (Small and Nicholls 2003), creating a population density around three times the world’s average (Kay and Alder 2007). This migration has resulted in around half of the world’s large cities (>500,000 people) being located within 50 km of the coast with a large percentage of their protein intake being reliant on the adjacent coastal fisheries (Millennium Ecosystem Assessment 2005a).

However, the majority of these habitats are not (or only partially) protected resulting in depleted stocks exacerbated by overfishing, and illegal and destructive practices. Nurseries, vital for fisheries production have been impacted due to habitat conversion or degradation as well as biochemical changes due to freshwater diversion and harmful algal blooms caused by eutrophic conditions. These depleted stocks have caused the increase in aquaculture bringing with it, its own set of problems such as the overexploitation of remaining fisheries for fishmeal, and the increase of pollution such as excess nutrients and pharmaceuticals such as antibiotics and anti-fouling agents (Millennium Ecosystem Assessment 2005b). Increased maritime shipping transportation has also exacerbated the occurrence of marine invasive species, sometimes drastically changing the local ecosystem functioning and stability (Bax et al. 2003, Gurevitch and Padilla 2004, Molnar et al. 2008).

The increasing coastal population has resulted in the further development of hard coastal infrastructures such as urbanisation, ports, harbours, resorts, and erosion protections measures such

as groynes, breakwaters and seawalls. Given the historic propensity of humans to construct their cities near ecologically productive areas to ease their access to such resources, urban areas have begun to encroach on, and irreversibly destroy these habitats. Inland activities have decreased the amount of sediment reaching the coastal zone (by about 10%) but increased the amount of nutrients (by 100%) and other land pollution, resulting in the most chemically altered ecosystems in the world (Millennium Ecosystem Assessment 2005b). Coastal systems are also particularly sensitive to impacts of climate change including coastal erosion and flooding caused by rising sea-levels and increased severe storms; and changes in ecosystem functioning caused by acidification and rising sea temperatures (Wong et al. 2014). A summary of the drivers of these human impacts in the coastal ecosystems is shown in Table 1 (Millennium Ecosystem Assessment 2005b).

Although there has long existed local and regional interest in conservation and preservation of the natural environment, widespread public acknowledgement of environmental issues only began in the mid-twentieth century with publications such as *Silent Spring* (Carson 1962), *The Population Bomb* (Erich 1968) and *The Limits to Growth* (Meadows et al. 1972). This has helped increase demand for managing these ecological impacts, either to mitigate or prevent them from occurring.

Table 1: Direct and indirect drivers of change in coastal ecosystems (Millennium Ecosystem Assessment 2005b)

Direct Drivers	Indirect Drivers
<b>Habitat Loss or Conversion</b>	
Coastal development (ports, urbanization, tourism-related development, industrial sites)	population growth, poor siting due to undervaluation, poorly developed industrial policy, tourism demand, environmental refugees and internal migration
Destructive fisheries (dynamite, cyanide, bottom trawling)	shift to market economies, demand for aquaria fish and live food fish, increasing competition in light of diminishing resources
Coastal deforestation (especially mangrove deforestation)	lack of alternative materials, increased competition, poor national policies
Mining (coral, sand, minerals, dredging)	lack of alternative materials, global commons perceptions
Civil engineering works	transport and energy demands, poor public policy, lack of knowledge about impacts and their costs
Environmental change brought about by war and conflict	increased competition for scarce resources, political instability, inequality in wealth distribution
Aquaculture-related habitat conversion	international demand for luxury items (including new markets), regional demand for food, demand for fishmeal in aquaculture and agriculture, decline in wild stocks or decreased access to fisheries (or inability to compete with larger-scale fisheries)
<b>Habitat Degradation</b>	
Eutrophication from land-based sources (agricultural waste, sewage, fertilizers)	urbanization, lack of sewage treatment or use of combined storm and sewer systems, unregulated agricultural development, loss of wetlands and other natural controls
Pollution: toxics and pathogens from land-based sources	lack of awareness, increasing pesticide and fertilizer use (especially as soil quality diminishes), unregulated industry
Pollution: dumping and dredge spoils	lack of alternative disposal methods, increased enforcement and stiffer penalties for land disposal, belief in unlimited assimilative capacities, waste as a commodity
Pollution: shipping-related	substandard shipping regulations, no investment in safety, policies promoting flags of convenience, increases in ship-based trade
Salinization of estuaries due to decreased freshwater inflow	demand for electricity and water, territorial disputes
Alien species invasions	lack of regulations on ballast discharge, increased aquaculture-related escapes, lack of international agreements on deliberate introductions
Climate change and sea level rise	insufficient controls on emissions, poorly planned development (vulnerable development), stressed ecosystems less able to cope
<b>Overexploitation</b>	
Directed take of low-value species at high volumes exceeding sustainable levels	population growth, demand for subsistence and market goods (food and medicinal), industrialization of fisheries, improved fish-finding technology, poor regional agreements, lack of enforcement, breakdown of traditional regulation systems, subsidies
Directed take for luxury markets (high value, low volume) exceeding sustainable levels	demand for specialty foods and medicines, aquarium fish, and curios; lack of awareness or concern about impacts; technological advances; commodification
Incidental take or bycatch	subsidies, bycatch has no cost
Directed take at commercial scales decreasing availability of resources for subsistence and artisanal use	marginalization of local peoples, breakdown of traditional social institutions

## 1.2 Managing ecological impacts in the coastal zone

In any decision to exploit the local ecosystem services, there is normally a trade-off between short term economic benefits and degradation of other services on that same system. Whilst the benefits are often short-term, the costs are often long-term and in some case irreversible (Millennium Ecosystem Assessment 2005b). It is often not clear which stakeholders and which ecosystem services are involved in this trade-off. Additionally, it is difficult to fully evaluate the value of some of these services and over which time period this analysis should be undertaken. This lack of information and knowledge can provide decision-makers with a difficult or near-impossible task.

Often the trade-off is related to those who have access to a service or resource and those who will benefit from coastal development. Environmental Impact Analyses (EIA) try to take the complete value of all services into account when deciding on a proposed project, and help decision-makers in this trade-off. However, these studies require costly detailed information which may be lacking or in some cases impossible to attain. There is the additional problem of cumulative impacts on an ecosystem service. Perhaps the project under assessment might not be so harmful, but the combined effects with (past, current or future) developments might cause a synergistic effect in the system, causing a greater impact than the sum of the individual projects. A regime shift (Holling and Gunderson 2001) can occur in an impacted ecosystem due to an increase in perturbations (e.g. excess nutrients causing eutrophication; and fishing stocks unable to recover from overfishing). The exact quantity of perturbations or disturbances an ecosystem can absorb before changing regime is hard to predict, but once a threshold has been crossed, it is sometimes more difficult to return to the original state (Folke et al. 2004, Walker and Meyers 2004).

An additional problem in managing coastal zones is that sometimes the source of the impact is upstream or outside from the political jurisdiction of the decision makers: For example: sea level rise caused by climate change; and coastal erosion caused by damming of rivers previously supplying sediment to the coast. Clearly decision-makers have a difficult task in balancing these trade-offs even without considering questions of power, influence, institutional rigidity, illegal activities and higher level political decisions. Historically due to the complexity of issues described above, responses to ecological impacts have only been implemented after the impact has already occurred; meaning management practices have largely been reactive and often only directed towards a single threat or disturbance. More recently, there has been a move towards a more “holistic” approach in which multiple human activities and impacts are taken into account across a range of sectors. This requires a co-ordinated response regarding coastal development, pollution control, and over-



exploitation of biological resources, using the best available scientific research together with a continual discourse with decision-makers, stakeholders and the public.

Management of coastal development has been increasing over the last few decades such that by 2001, there were a total of 698 coastal management initiatives operating worldwide in 145 nations (Sorensen 2002). Management of pollution in coastal areas has had a limited effect due to the disperse source of the pollutants (e.g. agricultural runoff). Other actions such as reducing municipal waste and urban runoff limiting hydrocarbons and other toxic inputs has had mixed results (Millennium Ecosystem Assessment 2005b). Fisheries management has moved towards an ecosystem-based approach where the multispecies interactions and trophic chains are taken into account in order to analyse the systemic effects of over-exploitation of stocks and habitat loss and degradation. Coastal habitats are often central in reproduction of stocks as many species use this zone as a nursery, and therefore fisheries are sensitive to changes in coastal conditions.

Initiatives such as the Integrated Coastal Zone Management (ICZM), Water Framework Directive and Land-Sea Interactions in the Coastal Zone, have tried to couple coastal and land based activity but this requires large scale integrated management practices for the effective management of coastal and marine systems. ICZM encourages integration and co-operation across levels of governance, from the national and regional to local level. In previous management frameworks, a “top-down” approach was generally applied where administrative decisions were taken whilst trying to improve sustainability. A “bottom-up” approach is community-based where local stakeholders who perceive disturbances to the local environment can call attention to the impact, and begin a consultation with decision-makers and other relevant stakeholders. Without strong social, neither a purely top-down nor bottom-up approach will be successful capital (OECD 2001, Ostrom and Ahn 2010).

So in summary, there are technological, social and institutional issues involved in the successful management of coastal zones. Integrated assessment modelling has been developed to start to answer some of these issues.

### 1.3 Integrated assessment modelling

Given the complexity involved in managing systems towards sustainability, there is a trend towards taking into account ecological, social and economic values in the decision making process. This “meta-discipline” is often referred to as Integrated Assessment (IA). Although the roots of IA began

with global and long-term environmental assessment, more recently it is being applied to other scales for a range of environmental problems including water and air quality management, land degradation, forest and fisheries management and public health. The key features of IA are diverse reflecting the transdisciplinary and multi-sectoral approach which Jakeman and Letcher (2003) summarise as:

- A problem-focussed activity, needs driven; and likely project-based
- An interactive, transparent framework; enhancing communication
- A process enriched by stakeholder involvement and dedicated to adoption
- Linking of research to policy
- Connection of complexities between natural and human environment; recognition of spatial dependencies, feedbacks, and impediments
- An iterative, adaptive approach
- A focus on key elements
- Recognition of essential missing knowledge for inclusion
- Team-shared objectives, norms and values; disciplinary equilibration
- Science not always new but intellectually challenging
- Characterisation and reduction of uncertainty in predictions

(Jakeman and Letcher 2003)

In order to facilitate the approach, models are often employed to gain understanding from the system in study and aid in the deliberation processes - known as Integrated Assessment Modelling (IAM). Although researchers had been using similar approaches involving integration of ecological models with socio-economic systems for some time, IAM was first explicitly conceived when Mitchell (1990) described integrating three systems of water management: quality and quantity of surface and groundwater; interactions between land and water; and the socio-economic component involved in management decisions of water. Research applying the IAM approach grew in multiple fields (Dowlatabadi 1995, Risbey et al. 1996, Rotmans and van Asselt 1996, Rotmans 1998) and theory, principles, frameworks and best-practices were established shortly after (Parker et al. 2002, Hare and Pahl-Wostl 2002, Jakeman and Letcher 2003, Jakeman et al. 2006, Newham et al. 2007, Liu et al. 2008). Despite these advances there is still no clear definition of what "integration" means or what needs to be "integrated". Hamilton et al. (2015) define ten key dimensions of IAM in three subsections:

- Key drivers of integration
  - (1) Issue(s) of concern
  - (2) Governance setting
  - (3) Stakeholders
  
- Aspects of system to be integrated
  - (4) Human setting
  - (5) Natural setting
  - (6) Spatial scale
  - (7) Temporal scale
  
- Methodological aspects requiring integration
  - (8) Scientific disciplines
  - (9) Methods, models, tools and data
  - (10) Sources and types of uncertainty

The focus of this thesis is modelling using IA (rather than the IA approach as a whole) so some of the key considerations regarding IA models will be presented below. For those that wish to further explore the other dimensions of IAM there exists an extensive range of literature discussing the theoretical and practical issues (Parker et al. 2002, Jakeman and Letcher 2003, van Kerkhoff 2005, Kelly et al. 2013, Strasser et al. 2014, Hamilton et al. 2015).

Integrated Assessment Modelling (IAM) is plural in its approach and does not specify any specific type of model. A model can be thought of as a simplification of reality and does not necessarily need to be a mathematical or simulation model. Possible types of models used in IA include: Data models; Conceptual or Qualitative models (visual or verbal descriptions of processes); Quantitative numeric models (formalisations of the qualitative model); Mathematical models (analysis of the quantitative model, interpretation of results); and Decision-making models (transformation of interpretive results into action) (Parker et al. 2002).

In IAM, simulation models using computer software enable the representation of complexities and interactions within the ecological, economic and social components of a system, comparing the costs and benefits of various scenarios. However it is important that the model is designed, constructed and displayed in an open and transparent process, in which the stakeholders feel comfortable

understanding the models results and conclusions as well as its limitations. When presenting a model to stakeholders, the results and information which it produces can be displayed using two different techniques. Most non-IA models try to optimise a set of variables for multiple objectives in order to ascertain the most desirable outcome. However this assumes certainty within the model and its predictive capacity, often over-simplifying the complexities within the system. An alternative, recommended in IAM, is to provide a set of scenarios which explore the controllable (e.g. management decisions) or uncontrollable (e.g. climate forcing) effects of variables within the system. This can help those involved in the decision-making process to better understand the functioning of the system, as well as the interdependencies and interactions of the processes. This approach is more cumbersome as it requires larger input data (for the controllable and uncontrollable input variables) and more time to program the software to implement multiple scenarios. In practice, most IA models use a combination of optimisation and scenario outputs in their approach, depending on the needs and requirements of the stakeholders, and the focus of the study. An output from an IAM model should not be presented as an accurate prediction for specific indicators within the system, but rather a set of outcomes each described with a degree of confidence. Ideally the degree of confidence of each outcome would be stated quantitatively, but in reality this is impractical and so are mainly qualitative (Jakeman and Letcher 2003).

When considering which type of IA model to use, there are three main criteria to consider. What is the objective of the model? Which types of data are available? And who are the model users? Kelly et al. (2013) defined a decision tree (Fig. 1) based on these criteria for deciding the optimal type of model.

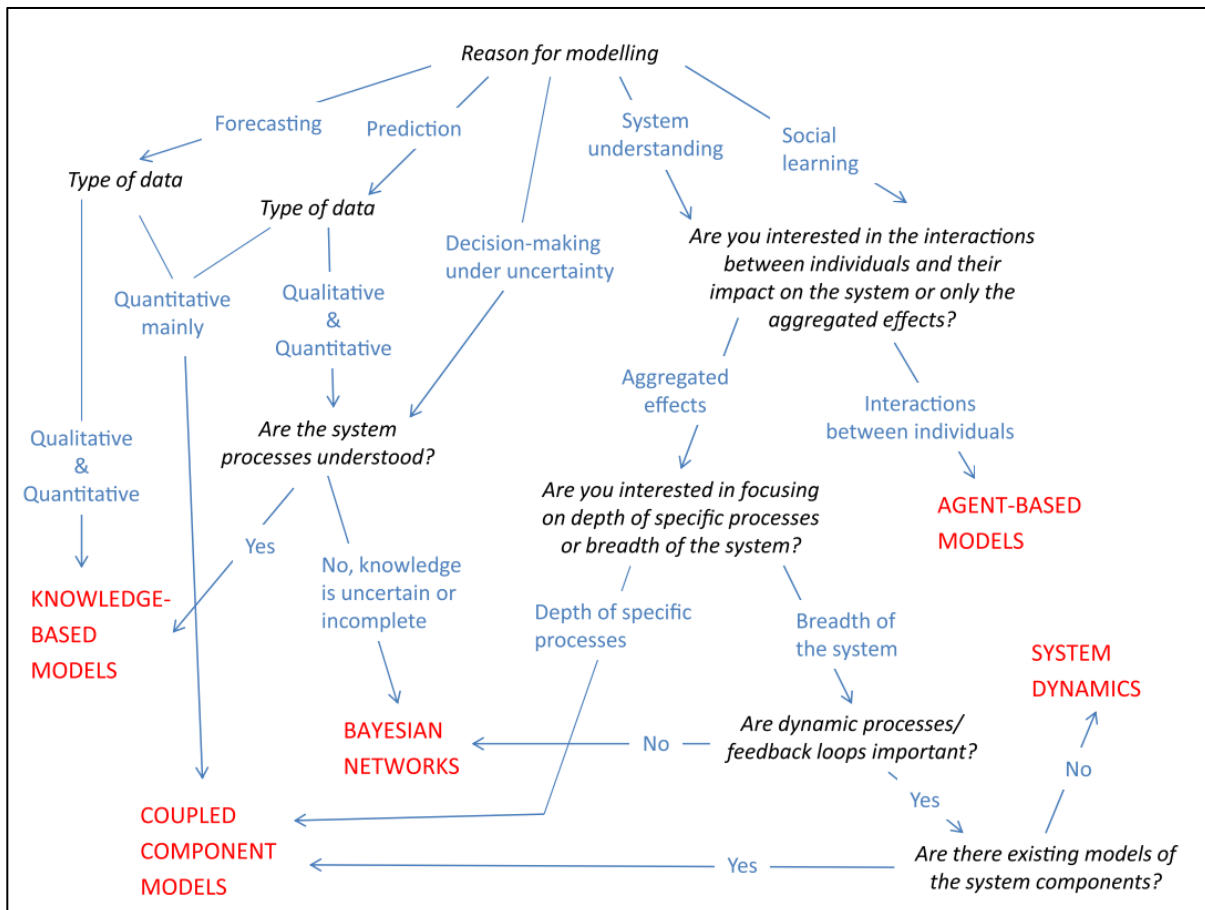
The objective of the model can broadly be described as one of five categories, although some models can have multiple purposes:

- *Forecasting* - involves predicting the value of a future variable based on historic data without using other variables in the system (e.g. rainfall)
- *Prediction* - similar to forecasting but with the added knowledge of other variables within the system (e.g. eutrophication of lake). Predictive models need to be calibrated and validated against historic data.
- *Decision-making under uncertainty* models are usually used in management type situations where the user wants to be able to make a trade-off between various scenario options. The

model needs to be able to make predictions regarding the magnitude and direction of key indicators.

- *System understanding* models try to include the best available knowledge where there is uncertainty in the system and help the user to understand the overall functioning of the system. The important aspect of the model is to show the direction of a set of indicators rather than their exact value. These models can either be used for research purposes or with stakeholders.
- *Social learning* models are similar to system understanding models, but are more focused on the interactions between groups or individuals rather than just the overall functioning of the system. The objective of both these types of models is not necessarily historical or predictive accuracy.

Fig. 1: Decision tree used for choosing appropriate type of model in IAM (Kelly et al. 2013)



When constructing a model, there is usually both quantitative and qualitative data available. Quantitative data is measurable, recordable information such as a stock or a flow. Qualitative data includes the information gained from surveys, interviews and expert opinions. Most models are constructed using qualitative data (although there are probably qualitative inputs into the design of the model such as expert opinion on what to include or exclude in a model, system boundaries, etc.) however some types of model can explicitly include qualitative data (e.g. Knowledge-based models and Bayesian networks).

The five types of common models used in IAM as defined by Kelly et al. (2013) are shown in the decision tree (Fig. 1). It should be noted that they are not mutually exclusive and an IA model might use components of more than one classification. A brief overview of each model type is described below. Kelly et al. (2013) provide an additional in-depth analysis of each model type.

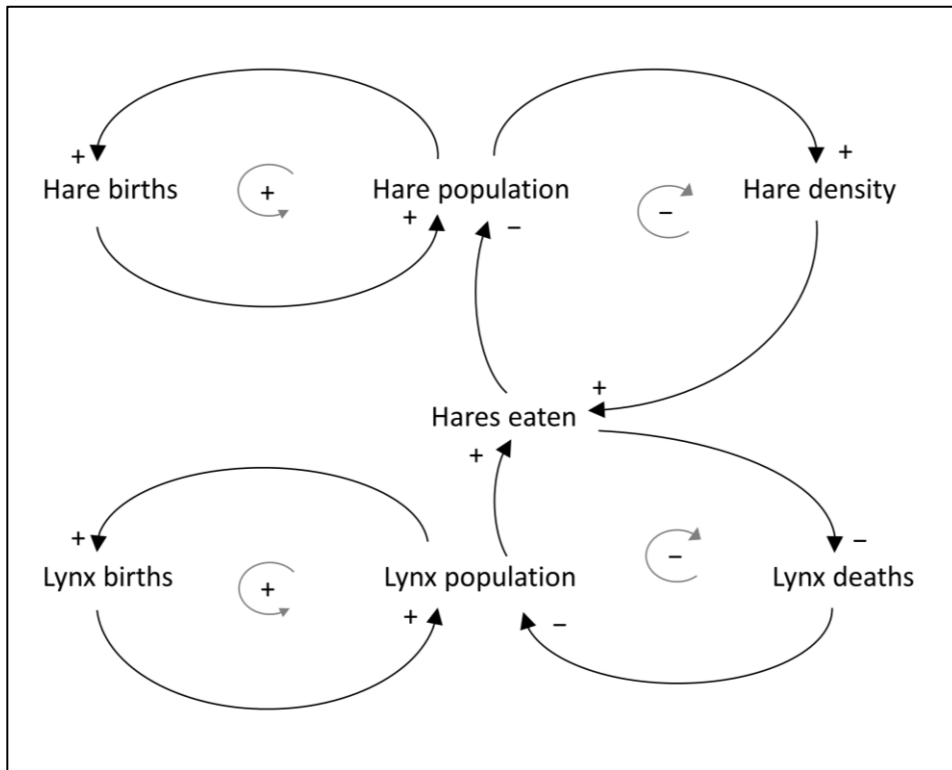
- System dynamics (SD)

Jay Forrester developed system dynamics (SD) whilst at MIT Sloan School of Management during the 1950s, a methodology and mathematical modelling framework which could be used to represent many of the ideas from the fields of Cybernetics (Weiner 1948, 1954) and General Systems Theory (GST) (von Bertalanffy 1950, 1968). SD places great emphasis on the importance of the structure of the system, feedback loops, delays, accumulations, amplifications and endogenous behaviour where the interaction between components in a system can be more important than the individual functioning of the components themselves (Forrester 1968). Key steps in modelling system dynamics include: define the boundary of the problem; draw causal loop diagram identifying main feedback loops (and whether they are positive or negative); convert to stock flow diagram; initialise or estimate levels and rates of stocks and flows respectively; simulate and analyse model output. Forrester regarded SD to be inherently more sophisticated than other forms of mathematical modelling because they omitted the multiple feedback loops and therefore could not reproduce the non-linear nature of real systems (Ramage and Shipp 2009). Due to the relatively intuitive and transparent structure of SD, it has often been used in mediated modelling (van den Belt 2004) and group model building (Vennix 1996).

Fig. 2 shows a simple example of a causal loop diagram with feedback loops. The next step in creating a system dynamics model would be to assign values to the stocks and flows. This same

model is shown in the ExtendSim software package in Fig. 4 in Chapter 1.4.1, with the values assigned and the model output.

Fig. 2: Causal loop diagram of a simple predator-prey ecosystem



This causal loop diagram represents a simple model of an ecosystem with a predator-prey relationship between lynxes and hares. It is not an accurate model of any ecosystem in particular – it is merely figurative for showing construction of a system dynamics model. Each population has a direct effect on the other. The lynx feeds on hares reducing the hare population. However, as the hare population decreases, then the lynx starve and their population decreases. Therefore the hare population recovers and the cycle begins again. There are two “positive” or reinforcing feedback loops representing the birth and population cycle of each species. If these loops were not connected to other parts of the model, then both populations would increase exponentially. The other two feedback loops in the diagram are “negative” or balancing. These create a dampening effect in the model removing the exponential increases caused by the reinforcing feedback loops.

SD models tend to be spatially aggregated, but occasionally use a limited number of spatial compartments, and use discrete time. Each parameter needs to have a real world equivalent

and uncertainty is treated by using Monte Carlo simulations for analysis of input and parameter errors. SD is often used for system understanding or social learning type objectives. The focus on feedback loops helps to capture the overall system functioning rather than accurate prediction of system indicators. There are many SD software packages including Stella ([www.iseesystems.com](http://www.iseesystems.com)), Vensim ([vensim.com](http://vensim.com)) and ExtendSim ([www.extendsim.com](http://www.extendsim.com)). These software offer a user-friendly interface overlaying the stock-flow diagrams and mathematical equations, enabling non-modellers to easily manipulate the model (e.g. for policy-makers and other stakeholders in deliberation or social-learning contexts). Examples of SD being used in IAM contexts include coastal zone management (Chang et al. 2008), water resource management (Kuper et al. 2003, Fernández and Selma 2004, Qin et al. 2011), urban development (Lauf et al. 2012) and soil erosion and nutrient pollution (Yeh et al. 2006).

- Bayesian networks (BN)

BN are networks in which nodes are connected via probabilities rather than deterministic values. Nodes are connected by directional arrows which represent the causal flow of the system. Unconnected nodes are considered to be conditionally independent of each other. Each node is assigned a conditional probability distribution and receives an input from the parent's node. BN are directed and acyclic so cannot model feedback loops. BN can incorporate both quantitative and qualitative data so are useful when there is a lack of observed measurable data but where there exists expert opinion. Most BN models are neither spatial nor temporally explicit. For these reasons, BN are useful in decision-making contexts when there is uncertainty. Outputs can be presented as a probability for a set of input parameters. The direct cause-effect relationship is easy to understand and so is accessible for decision-makers and other stakeholders, both in designing and running the model. There exist many BN software packages available including Netica ([www.norsys.com](http://www.norsys.com)), Analytica ([www.lumina.com](http://www.lumina.com)), HUGIN ([www.hugin.com](http://www.hugin.com)), and BayesiaLab ([www.bayesia.com](http://www.bayesia.com)). Examples of BN being used in IAM contexts include fisheries management (Kuikka et al. 1999, Pollino et al. 2007, Levontin et al. 2011), water resources management (Molina et al. 2010), management of estuaries and coastal lakes (Borsuk et al. 2004, Ticehurst et al. 2007) and aquifer planning (Martín de Santa Olalla et al. 2007).



- Agent-based models (ABM)

ABMs use computational simulation in which the interactions of autonomous agents (individuals, groups of individuals, or biophysical aggregations such as water) are modelled in order to analyse the effects on the whole system. Agents' behaviour is governed by a set of rules depending on both their environment and other agents' actions. The set of rules can be updated during the simulation, representing a type of learning behaviour. ABMs often produce emergent behaviour due to these interactions, some of which can be counter-intuitive to initial expectations. ABMs are often used in social learning, experimentation and management support contexts as they are useful for creating a communal understanding of the system in question. They are often spatially and temporally explicit. Depending on the number of agents and rule sets, ABMs can have many parameters and require considerable computational resources for calculation. There exist various ABM software packages such as *Cormas* ([cormas.cirad.fr](http://cormas.cirad.fr)), *NetLogo* ([ccl.northwestern.edu/netlogo](http://ccl.northwestern.edu/netlogo)) and *Repast* ([repast.sourceforge.net](http://repast.sourceforge.net)) and have been used in IAM contexts such as land use (Filatova et al. 2011, Le et al. 2012), conservation management (Mathevet et al. 2003, Parrott et al. 2011) and agricultural management (Schreinemachers and Berger 2011).

- Knowledge-based models (KBM)

KBMs contain a database of knowledge in explicit declarative form. A set of logic inferences are introduced such that the model produces a set of conclusions based on connected deductions. KBMs are able to incorporate both qualitative and quantitative data, and are often based on expert opinion. KBMs are not normally temporal or spatially explicit and most often used in management and decision-making contexts. Examples of using KBMS in IAM include monitoring environmental effects of mining (Booty et al. 2009), water quality (Dai et al. 2004, Vellido et al. 2007), watershed management (Lam et al. 2004) and eutrophication (Marsili-Libelli 2004).

- Coupled component models (CCM)

CCMs combine components of models from different disciplines to create a hybrid model. This normally includes ecological, economic and social components creating an integrated model. CCMs can incorporate components from SD, BN, ABMs and KBMs as well as any other type of model. There is often difficulty in combining these components and the connection is often

weak depending on the original design of the component sub-model. The nodes of a CCM often tend to represent a sub-model and the connections between the nodes represent the link between them - which is often a single variable. They are spatial and temporally flexible due to the ability to incorporate any type of model. However, if one of the components is spatially or temporally restricted, then that component of the CCM will necessarily reflect the same limitation. CCMs tend to require large sets of qualitatively data, and require considerable testing due to their complexity. There are two ways to construct a CCM: The model can be constructed by connecting the original components in an ad hoc manner. This is generally easier and requires less investment in time and resources reprogramming or rebuilding the components. However this means the CCM will not have a user-friendly interface like those in SD, BN or ABM, which limits its use in group model building contexts or social learning. The alternative is to rebuild the components from the beginning which obviously requires considerable time and resources but has the advantage of being able to adapt any sub-models specifically for the CCM. This second option is also more useful with using with decision makers or in stakeholder deliberation, as the model functioning will be more transparent and understandable. Due to their flexibility, CCMs have been used extensively in IAM including water management (Letcher et al. 2006, Matthies et al. 2006, Schlüter and Rüger 2007), land use (Fischer and Sun 2001, Münier et al. 2004), catchment management (Voinov et al. 1999, Van Delden et al. 2007), and climate change (Rivington et al. 2007).

The Systems Approach Framework is step-by-step methodological framework designed for coastal zone systems which includes many of the principals of IAM.

#### 1.4 The Systems Approach Framework

The Systems Approach Framework (SAF) was a methodological framework developed and tested during the four-year FP6 European Union project “Science and Policy Integration for Coastal System Assessment” (SPICOSA 2011) from 2007-2011.

*“The objective was that it would be a self-evolving, holistic research approach for the integrated assessment of complex systems so that the best available scientific knowledge could be mobilized in support of deliberative and decision-making processes aimed at improving the sustainability of Coastal Zone Systems (CZS)”*

(Hopkins et al. 2011)

SPICOSA involved 54 institutional partners from 21 countries across multiple scientific disciplines, costing around €14.3 million. The SAF was applied across 18 study sites, involving the participation of research institutes, universities, private enterprises, as well as local coastal zone stakeholders spanning a broad political spectrum from regional governance institutions to local organisations and individuals. The SPICOSA project produced a website where further details regarding the project can be found including models produced by the study sites as well as a model building block library, and an online data portal ([www.spicosa.eu](http://www.spicosa.eu)). The SAF methodology is available in an online handbook ([www.coastal-saf.eu](http://www.coastal-saf.eu)) and includes a comprehensive step-by-step guide to apply the SAF, with examples, supporting information, glossary and additional resources. A textbook was also produced by seven senior natural and social-science researchers from the SPICOSA project, drawing on insights made following the application, testing and review of the Systems Approach Framework in the study sites (Bailly et al. 2011).

The SAF views coastal zones as complex adaptive systems which are typically stressed and far from equilibrium (Hopkins et al. 2011). It is not sufficient for scientists to simply record the changes in natural systems, providing indicators and policy recommendations. Scientists have to apply soft systems thinking, working together with stakeholders and policy makers in order to improve the possibility of sustainability within social-ecological systems (Hopkins and Bailly 2013). The standard scientific method of investigation is object-oriented, typically analysing the stocks and flows of mass and energy, accumulating large quantities of data and knowledge but is necessarily reductionist in its approach. Human systems require an issue-oriented investigation from a holistic perspective (Hopkins et al. 2011). The success of a social process requires dissemination of ideas from all stakeholders, inclusion of multiple viewpoints, deliberation, and joint decisions. Checkland (1981) views the investigation of social and natural sciences to be fundamentally different and the application of hard systems science to the social world would not be successful.

“... the social and natural sciences cannot be regarded as similar enterprises using, or seeking to use a common method. Rather ... the investigation of social reality is fundamentally different from the investigation of the natural world”

(Checkland 1981) p246

The SAF attempts to create a balance between General Systems Theory (von Bertalanffy 1968) and Soft Systems Methodologies (Checkland and Scholes 1990), by both modelling complex systems and

creating a science-policy interface. Recognising the importance of the social process is crucial to the success of any management framework, thus combining the two methodologies can improve the possibility of sustainable social-ecological systems (Hopkins et al. 2011). The science-policy interface is often imagined as a direct, lineal connection where scientists present their research and findings to the policy makers who then base their policy decision on this knowledge. This is increasingly been seen as simplistic and unrealistic for a number of reasons. Scientists do not have access to “complete” knowledge, as their conclusions are based on a number of theoretical perspectives and worldviews, often fragmented into various disciplines. Additionally, there is no guarantee that policy makers will adhere to the scientists’ recommendations due to political and institutional pressure. For a management framework such as the SAF to be successful, scientists should therefore accept the weaknesses in their recommendations and engage with stakeholders and policy makers to effectively communicate both their recommendations and the limits of their knowledge. By engaging with stakeholders and policy makers, scientists can attain further knowledge and incorporate them into their research. Stakeholders can attain further confidence in both the scientists’ recommendations as well as the perspectives of the other stakeholders during this process as well.

The SAF was designed to be an open methodological framework incorporating systems thinking and existing methodologies such as ICZM. The methodological guidelines for the SAF were divided into a five step iterative process as detailed below. However, in concurrence with “systems thinking”, the SAF cannot be understood by merely reducing it to a rigid set of rules (Hopkins et al. 2011). The SAF is comprised of characteristics which should be understood in order to ascertain the intention and thinking of a SAF application as described in Hopkins et al. (2011):

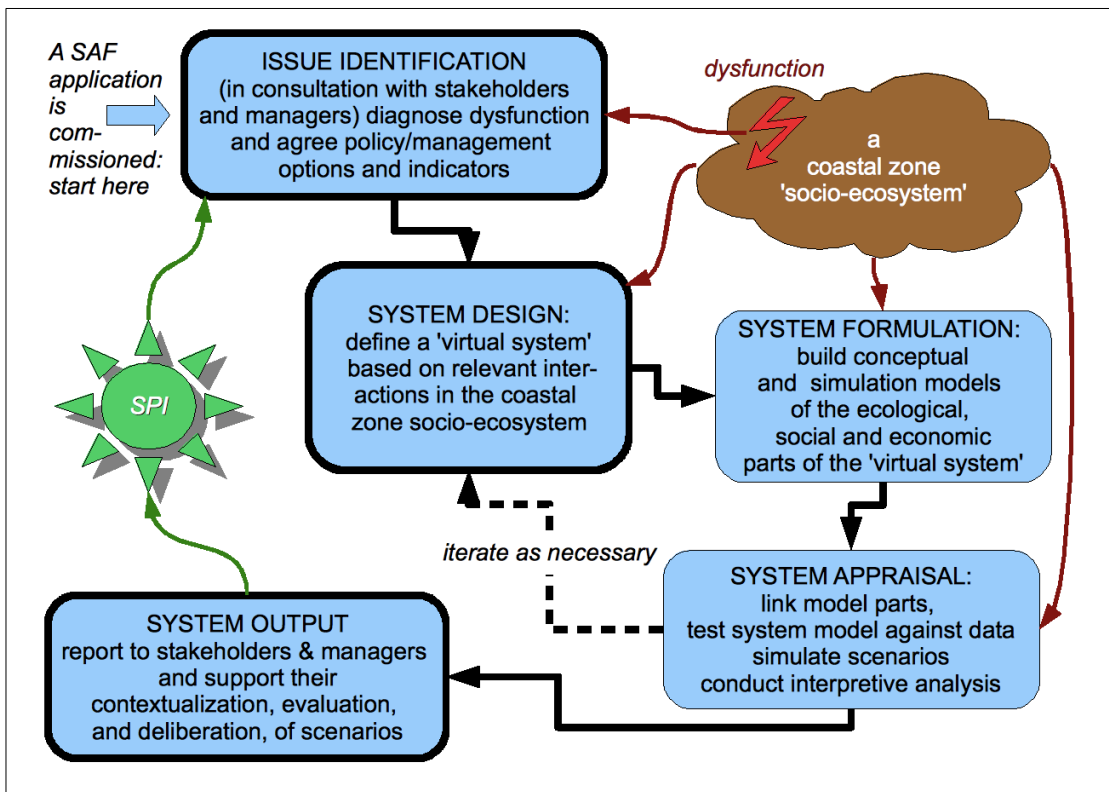
- A SAF application is *question driven*. An observed impact in the study zone with possible future scenario options are selected and evaluated. During the SPICOSA project, the scientific researchers involved in the SAF application (referred to from here as the “scientific team”) selected the question or issue to be studied together with the stakeholders. In future applications, individual stakeholders could propose an issue to be studied and the scientific team would join the application along with other stakeholders not involved in the original proposal.
- A SAF application is *holistic*. The stakeholders and scientific team should recognise that the issue selected for study, affects and is affected by interactions at both higher and lower scales. Obviously not all interactions can be included in the model, so the scientific team must be careful to include those interactions which are the most influential in determining the functioning of a system.

- A SAF application is *hierarchical*. The simulation model should be constructed in a way which captures the important interactions at each scale. During deliberation sessions, the stakeholder should be presented with a model that initially demonstrates the higher scale interactions of the issue being studied. If the stakeholder chooses to, they can investigate the lower scale interactions by “opening” sub-models to further understand the process involved in each. The software ExtendSim (Chapter 1.4.1) has the ability to create models in such a format and was therefore selected for use during the SPICOSA project.
- A SAF application is *iterative*. Once an issue has been selected, the scientific team will construct a model which represents the relevant parts of the social-ecological system. The scientific team should discuss the model and the possible scenario options with the stakeholders during this process to ensure that the model includes the key interactions and policy options – analysing, evaluating, and refining the model until it is ready to be presented to the stakeholders for deliberation. Following deliberation, a policy option may be chosen by the stakeholders (although the policy option could be “business as usual”, i.e. no change). Those involved in the SAF application continue to monitor the impact within the study zone, making any necessary adjustments to the model and presenting the new model results to the stakeholders. Similarly it might be necessary to expand or reduce the initial issue selected by the stakeholders as more knowledge is gained during the process.
- A SAF application is *system dependent*. A simulation model created during the process is specific and applicable only to that social-ecological system, and would therefore not be applicable anywhere else. However, certain sub-models or components could be used in other study sites for a similar issue, although certain parameters would need to be adjusted. Again, ExtendSim was chosen as the software for the SPICOSA project due to the ability to create sub-models or blocks which can easily be transferred to other models.
- A SAF application emphasizes the importance of *information flow*. As well as modelling the flow of mass and energy, a SAF model should try to include the flow of information.
- A SAF application is *communicable*. Given that the model (or at least the model results) ideally would be used by stakeholders during a deliberation process to decide on a future policy option, the model has to be clear and understandable.
- The SAF is an *operational tool*. The SAF methodology was designed to be flexible, open and self-evolving, so that it can be used in conjunction with other management frameworks and research tools. Additionally it can be used to highlight knowledge gaps, in education and training, monitoring the status of a system, and changes in public perception.

- A SAF application uses *simulation software*. Although the SAF methodology does not specify any particular software, it should be able to fulfil the characteristics mentioned above, to produce a hierarchical modular model which is user friendly and communicable. The software chosen by the SPICOSA co-ordinators was ExtendSim and is further described in Chapter 1.4.1.
- A SAF application constructs a *virtual system*. It should be reiterated again that the SAF methodology does not necessarily intend to create models that accurately model all components of a system. Given that there will be gaps in both knowledge and data; the SAF acknowledges that all models will be an abstraction of the real system. The objective of the SAF is to identify and include the most important interactions that most strongly influence the overall functioning of the system, and those which are most relevant to the chosen issue. As further data and knowledge becomes available, the iterative nature of the methodology means that they can be included in the future. Similarly, the flexibility of the virtual system means that system boundaries can be extended or reduced depending on the change in focus and resolution required for the chosen issue.

During the SPICOSA project a *SAF handbook* was created to aid researchers in applying the SAF to their study zone. This five step iterative process is available online ([www.coastal-saf.eu](http://www.coastal-saf.eu)) and includes examples of how to carry out each step and example models created during the SPICOSA project. Further information regarding this process is described in Hopkins et al. (2011) and Bailly et al. (2011). A brief outline of the SAF handbook is presented below as it is too detailed to include the complete description here. The two applications of the SAF presented in this thesis are described in the same five steps as the handbook as shown in Fig. 3 (Issue Identification; System Design; System Formulation; System Appraisal; and System Output). The first and final steps are holistic in their approach whereas the middle three steps are necessarily reductionist. It can be seen that the structure of these five steps is iterative, both during the construction of the simulation model (System Design, System Formulation and System Appraisal), and the process as a whole. Once a model and their results have been used during stakeholder deliberation (System Output) a policy decision might be taken which could affect the system in question. This might lead to changes in the system such that the original SAF model needs to be adjusted or possibly that an additional SAF application might be necessary. This is indicated in Fig. 3 as the Science-Policy Interface (SPI).

Fig. 3: The five steps of a SAF application (www.coastal-saf.eu)



- *Issue Identification*

A SAF application may be started by scientists, policy makers, environmental managers, regional planners or other stakeholders who have identified an environmental problem which is being impacted upon by a human activity. A scientific team should be formed consisting of researchers with knowledge of the ecological, economics and social aspects of the issue. This makes a SAF application a multidisciplinary approach where knowledge must be shared. Ideally, through a shared understanding of the issues this would create an *interdisciplinary* scientific team. This is challenging given the knowledge, technical language and worldview of researchers from their various disciplines. The scientific team may be expanded or reduced during the SAF application depending on the chosen issue.

Once a scientific team has been formed, an initial study should be undertaken to understand the relevant ecological, economic and social aspects of the system as well as understanding the SAF methodology in general. A list of human activities and stakeholders in the study zone impacted by the issue or problem should be made. Not all of these activities need necessarily be used in

creating the simulation model. An institutional map should also be created to understand the governance structure related to the issue and human activities. Although the issue may be already clearly defined, it could also be a vague problem or perturbation in the system.

From here, the relevant stakeholders and scientists should meet to discuss the issue, identifying and agreeing on the dysfunction in the social-ecological system as well as the ecological, economic and social indicators; the policy/management options; and potential future scenarios to investigate. This is potentially one of the most difficult steps to implement due to the possible reluctance of some stakeholders to participate in this initial dialogue. During this initial meeting additional relevant stakeholders might be identified who should be invited to participate in the process in the future.

- *System Design*

This step begins the process in which the real system is reduced to a conceptual model and eventually a mathematical simulation model. This step can be undertaken alone by the scientific team or together with the stakeholder group. It is likely that this step is carried out just by the scientific team due to its technical content, but the conceptual model should be presented to and agreed upon by the stakeholder group before proceeding to the next step. The stakeholders understanding of the functioning of the socio-economic system is likely to be diverse and a consensus should be sought. Knowledge and data gaps in the proposed virtual system will become apparent and steps should be undertaken to overcome this, either by searching for more data or relevant substitutes or proxies and by using expert opinion.

The key cause and effect chains of human activities and ecological interactions are identified, and virtual system boundaries are created taking into account the model output indicators and scenarios and management options decided upon during *Issue Identification*. Risks and hazards should also be identified and decided whether they should be included within the virtual system boundaries or as an external forcing. This information should be formalised into a conceptual model demonstrating the links between models, sub-models and components. Various conceptual models could be made highlighting the differing scales, or understanding of the real system. The conceptual model needs to capture the behaviour of the real system, particularly the emergent properties and non-linear behaviour caused by feedback loops. However, the model cannot be overly complex, so that construction and simulation are feasible. Various parts



of the conceptual model will likely need to be scaled either up or down: including or removing components and variables; adjusting boundaries; and increasing or decreasing temporal and spatial resolution and dimensions. The time-step of the simulation model should also be decided upon and will depend on the issue chosen and interactions within and between the model components.

Construction of the conceptual model is likely to bring greater understanding of the real system to both the scientific team and the stakeholders, due to the interdisciplinary nature of the model. A simple example of how to create conceptual model according to the SAF methodology is shown in Appendix I.

- *System Formulation*

Once the conceptual model has been designed, the process of collecting the relevant data and sub-model components begin. Firstly, the modeller must identify the useful inputs and variables and assess whether the data exists, and the format and resolution of the data. Data is often difficult to collect (due to intellectual property rights) and will need to be analysed, cleaned, converted and reformatted for the model in question. Variables must be identified for testing and calibrating the model. These can be state variables, fluxes or indicators. Sometimes there might be more than one relevant data set that can be used, so decisions must be taken as to which are more relevant for the model. The reliability and accuracy of the data should also be taken into account, as this will influence the reliability of the model output. If the data is unavailable and the scientific team cannot collect the data, then substitutes, proxies or an expert opinion “best guess” should be used. Alternatively, this lack of data may force the redesigning or rescaling of the conceptual model.

Using the conceptual model created in System Design, the various components and sub-models are constructed mathematically in the simulation software, carefully checking the correct use of dimensions and units - this can be particularly problematic when connecting separate components or sub-models. For complex sub-models and where relevant, a literature review of each type of sub-model should be undertaken so that the modeller is aware of the various methods and techniques available. Each sub-model should be tested separately with dummy input data to ensure correct functioning. Ideally sub-models and components should be constructed in such a way that each can be unconnected and replaced with an upgraded and

validated sub-model in the future. This ensures that if a sub-model is using simplified mathematical equations due to lack of data or knowledge of functioning, then in the future if this data or knowledge becomes available, it is easy to upgrade the model. Depending on the capabilities of the software and if the sub-model uses numerical integration techniques, various time-steps, time-per-steps, and integration algorithms should be tested to ensure its correct functioning.

Although the SAF handbook does not specify the type of model to be used, during the SPICOSA project there were recommendations to use *system dynamics* (Chapter 1.3) with the possibility of connecting to pre-existing sub-models. This recommendation influenced the sub-models built during the SPICOSA SAF application (Chapter 2).

- *System Appraisal*

Real data (as opposed to dummy data) is then introduced to the sub-models and its output compared against observed data. In certain cases, the sub-model will have to be calibrated where there are unknown parameter values. A sensitivity analysis should also be undertaken to see how the sub-model responds to changes in parameter values. Once the modeller is satisfied with the individual functioning of each sub-model, they should then be linked together to test the system model as a whole.

Once the complete system model has been constructed, the model should be run again with real data and the model output compared against observed data – known as a hindcast. Sensitivity analyses should be run for key parameters and variables. This is particularly important when there are feedback loops and/or time scale differences between sub-models. Once it has been determined that the model is stable and functions as required, and the hindcast produces results similar to observed data values, the various scenario and policy/management options chosen during Issue Identification can be run and the output recorded.

The System Design, System Formulation and System Appraisal steps are an iterative process in which adjustments are made to parameters and the sub-model is reformulated until the model output is determined to be sufficiently similar to observed data values. Although these three steps are presented here as separate steps to be carried out in order, in reality the process is

likely to be much more organic with all three steps being undertaken concurrently for the various sub-models of the system model.

During the final phase of System Appraisal, the scientific team should contact the stakeholders and ask how they prefer to view the model and results under the various scenarios and policy/management options. Some stakeholders might prefer to run the model themselves and others might prefer just to see the model output.

- *System Output*

The objective of System Output is to present the simulation model and its results to the stakeholder group and used in a deliberation process in which a policy or management decision might be taken. It is important for the scientific team to clearly explain the model and interpretations of the results as well as any weaknesses or limitations in the model. Technical jargon should be avoided as the stakeholder group is likely to be from a broad spectrum of professions, many of whom will not be used to scientific language. Comparisons of the various model scenarios should be shown to make it clear what the distinction is between each option, identifying costs and benefits of each, and the time scales involved. It might be useful to prepare a written document summarising the points made during the presentation. The complete model with input data and results should be made available to the stakeholder group to ensure transparency.

Following the presentation, a deliberation process could be undertaken with an impartial moderator, in which the stakeholders discuss the model, the scenarios options and the model results. Various techniques can be helpful in this deliberation process such as using the KerDST software ([dst.kerbabel.net](http://dst.kerbabel.net)) or simply using KerDST on paper, although a skilled facilitator would still be necessary for this.

A list of the policy issues selected by the 18 study sites involved in the SPICOSA project is shown in Appendix II. Further details regarding each study site are available in the special feature “A Systems Approach for Sustainable Development in Coastal Zones” in the journal *Ecology and Society* (Hopkins et al. 2011, 2012).

#### 1.4.1 ExtendSim

ExtendSim ([www.extendsim.com](http://www.extendsim.com)) was chosen by the SPICOSA project co-ordinators as the software to be used during construction of the SAF model simulations. ExtendSim has been used for modelling in various fields using a variety of modelling techniques including aeronautics, agent-based models, agriculture, architectural modelling, Bayesian networks, biofuel, communications, environmental modelling, manufacturing, healthcare, logistics, military, passenger flow, and queueing systems ([www.extendsim.com/sols\\_papers.html](http://www.extendsim.com/sols_papers.html)).

ExtendSim is commercially available software, although a free demo version is available in which previously constructed models can be run. This ensures that stakeholders can run any models and compare scenario outputs created during the SAF application even when they do not have access to the paid version of the software. ExtendSim models can be either continuous (as used in the SAF), discrete event or discrete rate. In continuous models, the time-step is fixed and advances in equal increments.

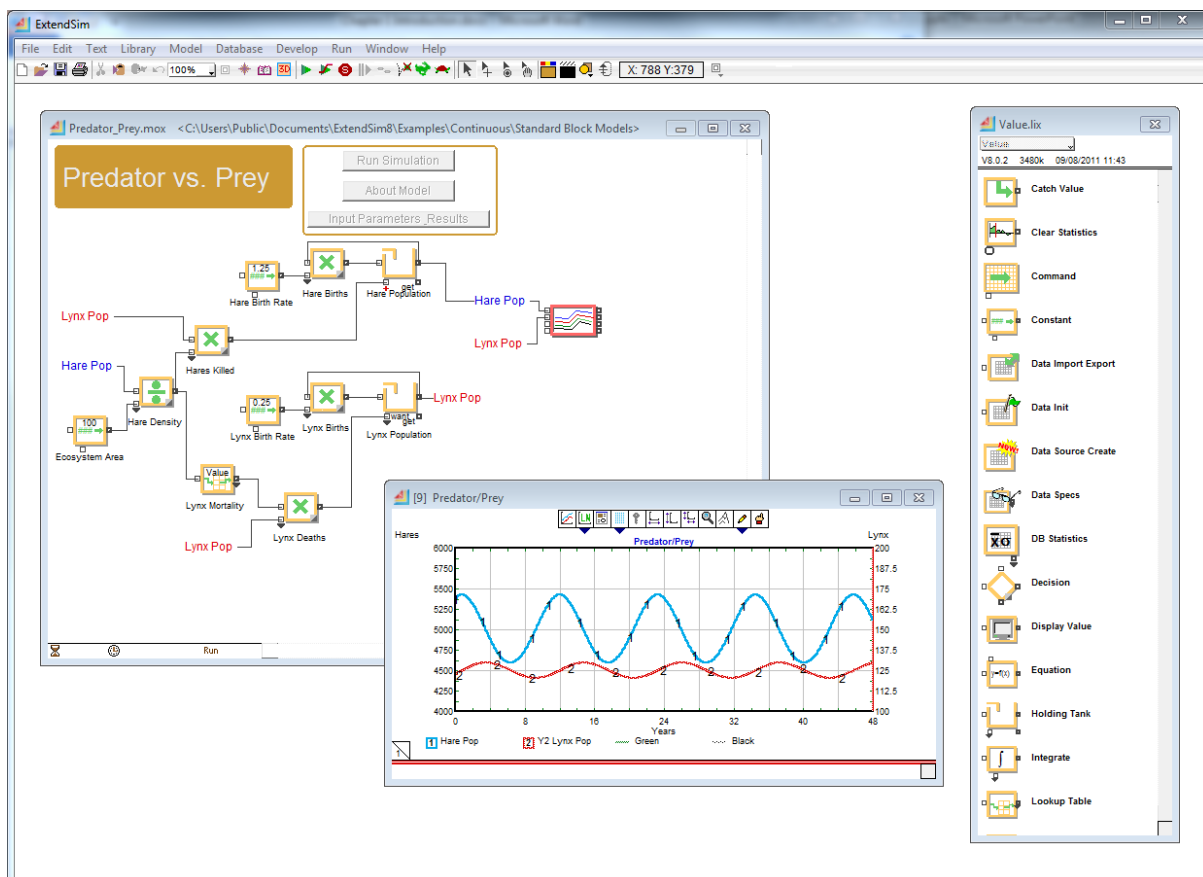
ExtendSim models are built using a library of blocks which can be dragged and dropped on the model worksheet. Each block represents a calculation or a step in a process. These blocks are then connected together creating an intuitive and logical view of the model. This means that constructing a model does not necessarily require programming in code. However if the modeller requires a block that does not exist in the ExtendSim library, then a new block can be created using the in-built proprietary coding language called ModL which is based on the programming language C. This ability creates flexibility and enables non-programmers to be able to use the software for most types of model, with the assurance that any type of block can be built if necessary.

A group of blocks can be combined together to create a new block creating a hierarchical model. Opening a combined block, the user can see the original blocks used. This hierarchical, modular capability is required for creating a SAF model as described in Chapter 1.4. However, a constraint of the software is that space can only be represented in a virtual sense with low resolution, so that box models must be used to represent spatial disaggregation (e.g. an estuary is represented in segments). It might in theory be possible to create thousands of blocks to increase the spatial resolution but the software would run very slowly. One of the requirements of the SAF is that the model must run quick enough (maximum of a few minutes) so that stakeholders do not become inattentive waiting for the model to produce its output results.

ExtendSim can connect to external software such as Excel, databases (via Open DataBase Connectivity), has ActiveX embedded and works with Dynamic Link Library. This can be useful during a SAF application if the model needs to connect to an external model or database. Within the software there is an evolutionary optimizer which is can be run when trying to calibrate the model with unknown parameters.

A screenshot of the ExtendSim software and an example predator-prey model is shown in Fig. 4. (This model is supplied as an example within the software). It is the same model as that shown in the causal loop diagram (Fig. 2) described in the system dynamics section in Chapter 1.3. On the right hand side of the screenshot, there is a window which contains the library blocks. These can be dragged and dropped on the worksheet on the left hand side. Once the blocks have been connected, parameters entered, and simulation settings defined (e.g time-step, length of simulation), the model can be run. The window in the centre of the screen will then appear and show the model output – in this case it is the population of the lynxes (predator) and hares (prey).

Fig. 4: Example ExtendSim predator-prey model (www.extendsim.com)



## 1.5 Structure and objective of thesis

The Systems Approach Framework was applied in two case studies in two separate European Commission Framework Programme projects entitled “Science and Policy Integration for Coastal System Assessment” (SPICOSA) and “Vectors of Change in Oceans and Seas-marine Life, Impact on Economic Sectors” (VECTORS). Each project and SAF application is described in detail in Chapters 2 and 3 respectively. The overall methodological framework applied in each case study was originally intended to follow the SAF as closely as possible, but this met with varying degrees of success. The exact method for each case study (identification of issue, construction of conceptual and mathematical models) is specific to each case study and therefore included in the relevant chapters. Each SAF application is documented using the five step framework as described in Chapter 1.4. Therefore for each SAF application the hypothesis is included in the Issue Identification step (Chapter 2.2 for the SPICOSA project application and Chapter 3.2 for the VECTORS project application); the method is documented in the System Design and System Formulation steps (Chapters 2.3 and 2.4 for SPICOSA and Chapters 3.3 and 3.4 for VECTORS); and the validation and results of the model are recorded in the System Appraisal and System Output steps (Chapters 2.5 and 2.6 for SPICOSA and Chapters 3.5 and 3.6 for VECTORS). For each SAF application there are conclusions and discussions for both the model and the SAF application as a whole (Chapter 2.7 for SPICOSA and Chapter 3.7 for VECTORS) - a SAF application is not only the construction of a model but also includes the process of stakeholder participation and deliberation. Finally a comparison is made of the two SAF applications in Chapter 4 discussing the similarities and differences, which parts of the SAF worked well in each case study and which did not, and some recommendations for the future.

The application of the SAF necessarily requires a multidisciplinary scientific team. It is unlikely that just one person would be able to carry out a SAF application by themselves. My role in each case study was that of a modeller which involved: participating in the scientific team meetings; consulting with experts in each field; designing the conceptual model together with experts; constructing, testing and validating the mathematical simulation model; running sensitivity and scenario analyses; and documenting the interpretive analysis of the model results. Although I was involved during stakeholder analysis and stakeholder meetings, this was not my primary role. Therefore during this thesis, I describe and analyse the parts of the modelling aspect of the SAF in greater detail than those aspects where I only partially contributed.

The objective of this thesis is therefore twofold. Primarily, the objective is to apply the methodology of the SAF in two separate case studies and analyse the modelling aspect of each. In each case study, the model, results and conclusions are compared with similar research already undertaken. A secondary objective is to compare and contrast these case studies, given that the same methodology was applied in approximately the same geographical location (although at different scales) where many of the institutional stakeholders share the same responsibilities. The hypothesis of this thesis is that the SAF is a useful methodological framework for improving sustainability in coastal zone systems, enhancing social capital between stakeholders as well as creating a common modelling structure that can be used in IAM. Following this, there is a discussion regarding the SAF methodology as a whole due to the participation of stakeholders in defining issues, scenarios and management options but it is not the central objective of this thesis. An analysis of the SAF methodology was already undertaken during the SPICOSA project across 18 study site locations and is fully documented as part of a special feature in the journal *Ecology and Society* (“A Systems Approach for Sustainable Development in Coastal Zones”) (Hopkins et al. 2012).

Included in Appendix XIII are two peer-reviewed papers, of which I am the lead author, relevant to this thesis. One has been published in the journal *Ecology and Society* (Tomlinson et al. 2011) and the other has been accepted by *Estuarine, Coastal and Shelf Science*.

## 1.6 Description of study zone

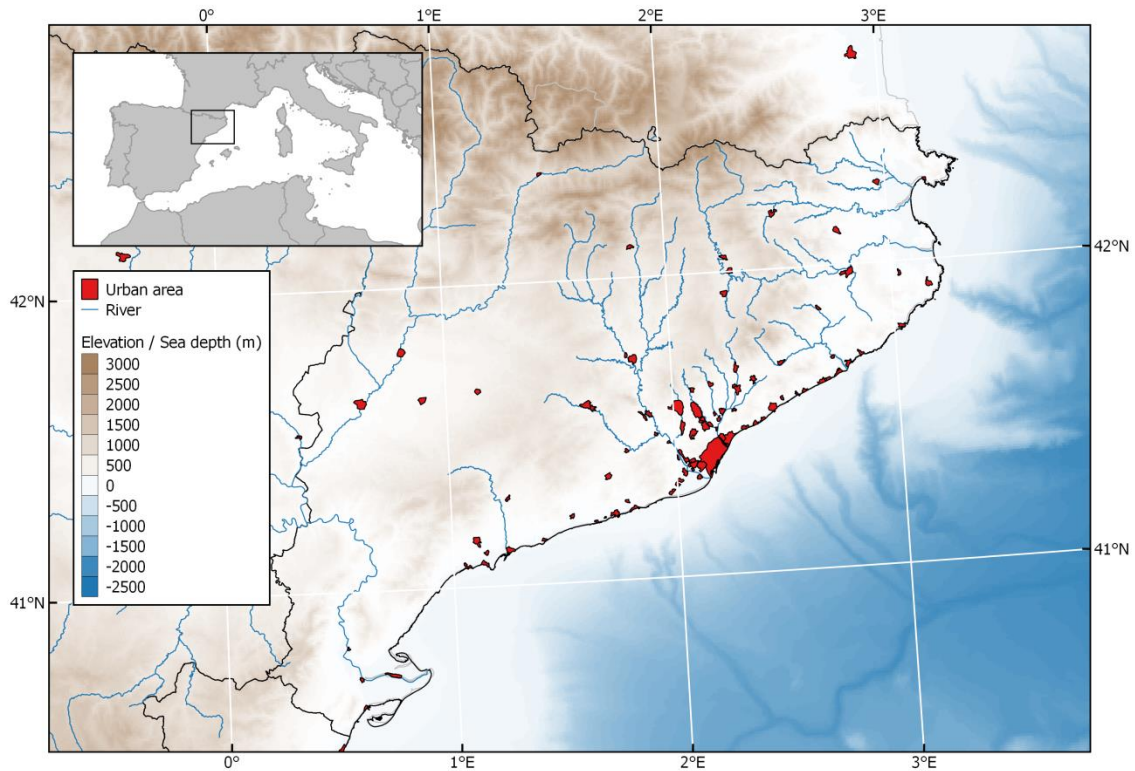
The SAF was applied in two case studies during two projects (SPICOSA and VECTORS) in the Spanish autonomous community of Catalonia. The SAF was applied during the SPICOSA project at the local scale – Barcelona (the principal city of Catalonia), and at the regional scale (Catalonia) during the VECTORS project. A brief introduction to the region and city is presented here although further relevant details are presented in each case study accordingly.

### 1.6.1 The Catalan coastal zone

The autonomous community of Catalonia situated in north-east Spain, in the north-western Mediterranean – between 40° 45' N to 42° 25' N latitude and 0° 45' E to 3° 15' E longitude (Fig. 5). The climate is typically Mediterranean with hot, dry summers and cool winters. The mean annual temperature range is 9-24 °C, with irregular precipitation throughout the year (500-700 mm)

although spring and autumn tend to be wettest (Flo et al. 2011). In general winds tend to be south-westerly, but during winter, winds predominately come from the North and North-west, especially in the north and south of Catalonia (Bolaños et al. 2009).

Fig. 5: Map of Catalonia indicating principal rivers and urban areas (>10,000 population)



The Catalan coastline is approximately 700 km long (IDESCAT 2010). The maximum tidal range is low - around 25 cm, with an average value of 16 cm (Cacchione et al. 1990). The geomorphological diversity is considerable. The average width of the continental shelf is 15-20 km (López 1995), reaching a maximum of greater than 60 km near both the Ebro delta in the south and the Gulf of Lions in the north (Palomera et al. 2007), and a minimum of 1.6 km near various underwater canyons (Flo et al. 2011). The predominant current is south-westerly along the continental shelf (the Liguro-Provençal current), which also delineates the less saline inshore waters from the open sea (Salat and Font 1987, Font et al. 1988).

The coastal waters are generally oligotrophic (Estrada 1996), with surface waters receiving nutrients through vertical mixing, local upwelling and terrestrial discharges. Vertical mixing occurs most frequently in winter during storms and wind mixing. During the rest of the year a strong thermocline



forms limiting vertical mixing. In spring and summer, nutrients arrive from increased river flow and episodic rain storms (Palomera et al. 2007).

The principal river along the Catalan coast is the Ebro River which discharges an average 416 m<sup>3</sup>/s from a catchment basin of 84 230 km<sup>2</sup> (Ludwig et al. 2009). Nine other medium-to-small rivers have a mean water discharge of 0.3-16.3 m<sup>3</sup>/s draining an area of 13 400 km<sup>2</sup> (Liquete et al. 2009). Within these river basins, the predominant land use is agricultural and forestal (up to 57% for each), although urban areas are also significant (up to 20%) (Flo et al. 2011).

Catalonia has a population of around 7.5 million with 44% living in the coastal zone (IDESCAT 2010). The population density varies considerable along the coast with 33 inhabitants/km<sup>2</sup> in the Ebro delta to 1,425 inhabitants/km<sup>2</sup> in the metropolitan area of Barcelona (IDESCAT 2010). The Gross Regional Domestic Product (GRDP) per capita of Catalonia was around €27,000 in 2014 (approximately €200,000 million for total GRDP), above the EU 28 average of around €25,000 (IDESCAT 2010, EUROSTAT 2014). The tertiary sector is the most dominant, accounting for around 60% of GRDP, with smaller secondary (37%) and primary (3%) sectors (IDESCAT 2010). The contribution of the tourism sector is significant, accounting for 9-11% of GRDP and around 17.7 million visitors per year (IDESCAT 2010). Much of this tourism is related to the “sun and sand” model, where a high importance is placed on the quality of climate and beaches (Sardá et al. 2005, 2009).

Catalonia is divided into four provinces (Barcelona, Girona, Lleida and Tarragona), which are further subdivided into *comarcas* and municipalities. The coastal zone is governed at the national (Spain), regional (Catalonia) and local (municipalities) scale. The principal legal responsibilities for beach and coastal management were enacted at the national level with The Shores Act 22/88, which ensures beach water and shoreline quality, regulates resources use, and ensures proper public use. The law defines the legal requirements of the *Maritime Terrestrial Public Domain* as a public good formed by the territorial sea, coastal waters, the natural resources within the exclusive economic zone and the continental shelf as well as the beaches and coastline up to 100 m inland. The Shores Act 22/88 describes the central government’s role in: supervising studies and projects in the coastal zone; authorising wastewater discharges into the coastal water; beach nourishment; regulating human safety in bathing areas; and maritime rescue.

The regional administration is responsible for management of the coastal area including land use and protection of natural communities, as well as assessing water and sand quality. The local

administration is responsible for running seasonal facilities, and maintaining the beaches clean and free of waste. Coastal and beach-use plans presented by local municipalities have to be accepted by the national and regional administration before being carried out. The Shores Act 22/88, despite establishing rules and governance responsibilities, does not provide details of funding for the management and enforcement of the law, nor does it enforce integrated approaches such as ICZM.

### 1.6.2 Barcelona

Barcelona is the capital of Catalonia, one of the most populated autonomous communities in Spain. There are more than 1.5 million inhabitants in the city itself, but almost 5 million people live in the area directly influenced by the city. The economy is focused largely on the service sector. The large metropolitan city of Barcelona is situated in the northeast of the Iberian Peninsula and is set between four geographical limits: the Mediterranean Sea to the east, the Serra de Collserola mountain range to the west, the River Besòs to the north, and the River Llobregat to the south.

Maritime trade has been always important to the city, so the necessity of having a safe harbour has been one of the most pressing forces in changing the littoral profile of the city. Barcelona's coastline can be considered altered or artificial since the beginning of the 15<sup>th</sup> century when the first transformations were made to enhance the protection of trade ships. The construction of dykes and breakwaters led to corresponding changes in sedimentary flows and the reclamation of almost 400 m of land from the sea. However, throughout the following centuries, the city has modified its relationship with the sea, and different ecosystem services have been prioritized.

The Olympic Games in 1992 and the Universal Forum of Cultures in 2004 were two internationally recognized events that reshaped Barcelona, both figuratively as a city, and literally in terms of its coastline. The existing industrial infrastructure was replaced with artificial beaches within an urban environment, which provided a leisure space for both residents and tourists. Fishing was also of considerable economic significance, but following the industrial revolution, its importance dramatically decreased and became a marginal traditional activity (Roig 1927, Bas et al. 1955).

Whereas in the past the main ecosystem services were related to food, transport, and waste disposal, nowadays navigation, recreation, and tourism can be considered the most important services for management issues (Novoa and Alemany 2005). The large industrial harbour and the public use of beaches for leisure are the two main uses of Barcelona's urban littoral space

There is an increasing trend in the promotion of intensive-use urban artificial beaches for tourism in many large cities on the Mediterranean Sea coast (Nicholls and Hoozemans 1996), but there has been little analysis of the possible interactions between the ecological, social, and economic components of the social-ecological system. This made Barcelona an interesting study site in which the capabilities of the SAF could be explored in a representative case of urban beaches on the Mediterranean Sea.

## **2 Application 1 (SPICOSA Project) – Beach water quality and beach users**

### **2.1 Background and context of the SPICOSA project**

Coastal zones are a prime example of valuable social-ecological systems under pressure (Costanza 1999, Costanza and Farley 2007, Martínez et al. 2007), and following the introduction of integrated coastal zone management (King 2003) concepts, a number of methodological frameworks have been suggested to enhance the efficacy of human decision-making processes with regard to sustainability (European Parliament and Council 2002, McKenna and Cooper 2006). One such framework is the Systems Approach Framework (SAF) developed and tested during the four-year FP6 European Union project “Science and Policy Integration for Coastal System Assessment” (SPICOSA 2011). SPICOSA ran from 2007-2011 and involved 54 institutional partners from 21 countries across multiple scientific disciplines, costing around €14.3 million. The SAF was piloted in 18 different study sites across Europe including the case presented here (Tomlinson et al. 2011) in order to test the application of the methodology to a varied set of social-ecological systems, although always within the domain of coastal zones. It should be noted that the methodology can be applied to any social-ecological system, not only those encountered in coastal zones. A special edition in the journal *Ecology and Society* includes analysis of all the study sites within the SPICOSA project (Hopkins et al. 2011).

It should be emphasised here that the SAF methodology was being designed, tested and modified during the SPICOSA project. The scientific team attended many meetings in which the theory and methodology were explained. We then applied this knowledge within the scope of our study site. The study sites were expected to already have access to most data needed for modelling. This was to prevent study sites having to spend time and resources on collecting additional data before they could start to build a model. Additionally, there was an expectation to use the SAF methodology for constructing models as described in Appendix I. The SPICOSA project managers did not want the study sites simply to use a pre-existing model and use it within the SAF application. A pre-existing model could be adapted to be used as a SAF model but within the guidelines described in the SAF methodology. As previously explained, a SAF model should be as simple as possible but still capture the important links and feedbacks of ecologic, social and economic components of the social-ecosystem. A SAF model should be hierarchical so that a stakeholder or model user can initially understand the broad overview of the model and then if they choose to, can investigate each component in more detail. In the SAF, the model is only as useful as the social context in which it is used – there is a lot of importance placed on the interactions of the stakeholders using the model as

a focus for understanding not only the social-ecosystem dynamics, but also understanding the point of view of other stakeholders.

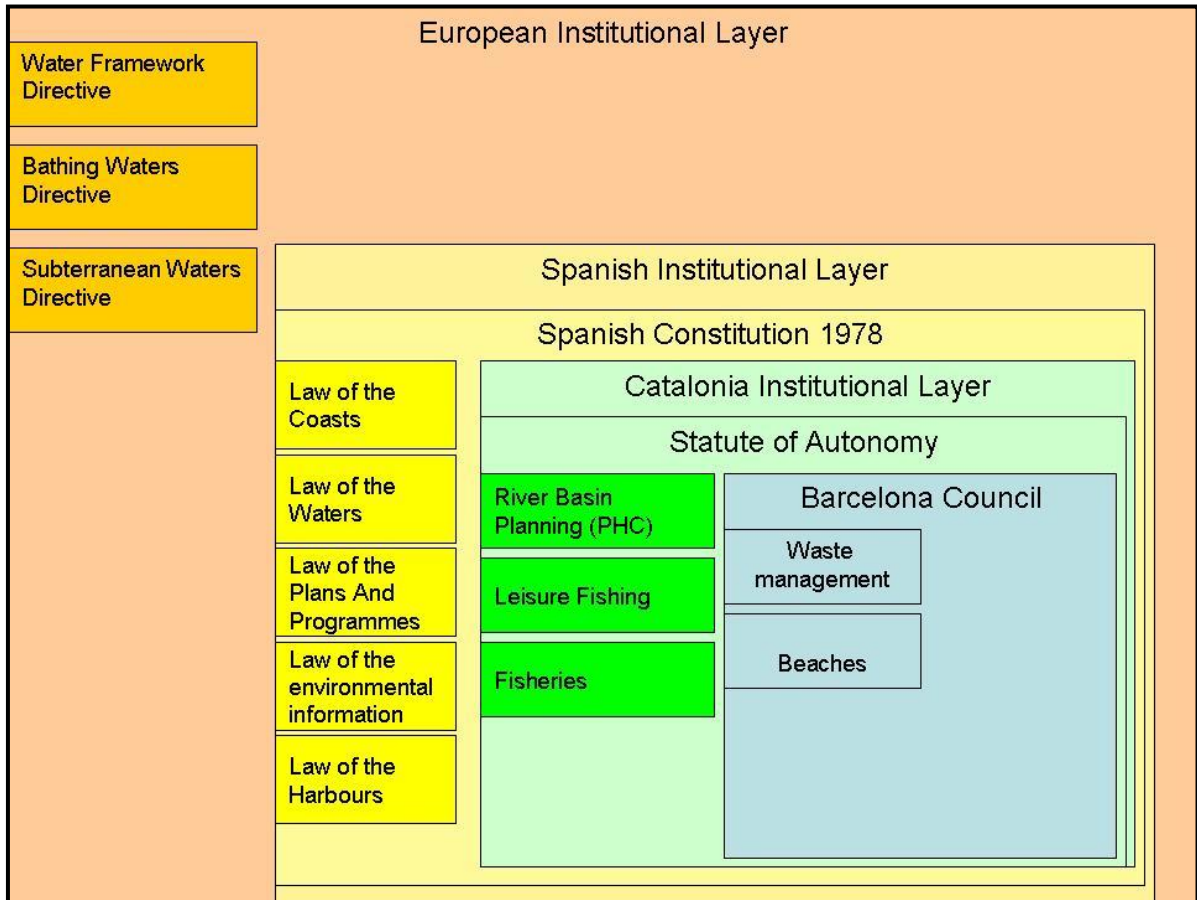
The scientific team within our research institute consisted of a broad spectrum of mostly natural scientists (biologists, ecologists and geologists) as well as an ecological-economist and a mathematical modeller (the author of this study). There was additional support from other participants in other research institutes, universities and consultancies within the SPICOSA project.

## 2.2 Issue Identification

The SAF methodology recommends constructing an institutional map of the study site in order to comprehend the administrative and institutional responsibilities of each stakeholder. In Barcelona, there are multiple nested hierarchies of institutional responsibilities (Fig. 6). At the largest scale is the European Union which implements European legislation and directives. These are then passed as laws by the Spanish state in agreement with the Spanish Constitution (1978). According to the Spanish Constitution, there are 17 autonomous communities (and two autonomous cities) that are then responsible for regulating and administering the laws. Barcelona is part of the autonomous community of Catalonia which has its own legislative body which governs issues at the regional scale. Finally there is Barcelona council who are responsible for the citywide issues. Some responsibilities and authorities operate at more than one scale.

At the time, there was no existing forum for these stakeholders to interact at the city scale, so we created one to meet the objectives of our SAF application. During the initial discussions about who would be invited to the first meeting, there was disagreement among the scientific group as to whether the more “conflictive” stakeholders (such as environmental nongovernmental organizations, surfers, local residents) should be included or not. The other stakeholders with more power in decision-making processes (public administrators) might have objected to their inclusion and therefore chosen not to attend the meeting, effectively ending the process before it started. It was decided that the potentially more conflictive stakeholders would not be invited initially but possibly would be included later following consultation with the other stakeholders. Public administrators would, in general, already be aware of the concerns of the more conflictive stakeholders. Table 2 provides a list of the stakeholders, their responsibilities, the meetings each one attended, and the issues they raised during the first stakeholder meeting.

Fig. 6: Institutional map of legislation relevant to Barcelona (Author: Sergio Sastre in System Design report for SSA12 -completed within the SPICOSA project)



There were four meetings in total with the stakeholders. The first meeting took place during *Issue Identification*, the second during *System Formulation* and final two meetings during *System Output*. During the first meeting, it became clear that a common issue of interest to most stakeholders was water quality, particularly following combined sewer overflow events. The interest in this issue arose partly from compliance obligations to various European Union directives (Directive 2000/60/EC, Directive 2006/7/EC), and partly because of a connection to the stakeholders' work responsibilities (e.g., decline in tourism at the recreational harbour caused by poor local environmental conditions).

Table 2: List of stakeholders that participated during SAF application (Tomlinson et al. 2011).

Scale	Organization	Responsibilities	Participation in Systems Approach Framework	Issues raised by stakeholders during first meeting
<b>State (Spanish government)</b>				
	Directorate of Coasts (Ministry of Environment)	Coastal spatial planning; public infrastructures; licensing; harbor administration	Contacted: attended first meeting	Erosion of beaches, especially during storms; toxic waste buried in offshore sand due to historic industrial activities; illegal recreational fishing near sewerage outlets
	Ministry of Works	Public Infrastructures	Not contacted	
<b>Regional (Catalan government)</b>				
	Directorate General of Fisheries	Recreational and commercial fisheries; monitoring	Contacted: attended first meeting	Municipal solid waste in artisanal fishing zones; effect of new coastal infrastructures on water quality; creation of artificial reefs
	Catalan Water Agency	Water management; waste water management; stormwater collectors planning; river basin planning; infrastructures; public information; flooding control; application of Water Framework and Bathing Water Directives; monitoring	Contacted: attended all meetings	
<b>Local (Barcelona)</b>				
	Department of Parks and Gardens	Beaches maintenance; end user satisfaction; water quality monitoring; noise control; licensing of businesses on the beach; public information; waste collection	Contacted: attended first and fourth meeting	Water quality following combined sewer overflows; erosion of beaches; jellyfish strandings; compliance with European Union directives
	CLABSA† (Private sector)	Sewage management and monitoring; stormwater collectors management	Contacted: attended the fourth meeting and a post-project meeting	
	Recreational Harbor	Licensing; waste management within the harbor	Contacted: attended first meeting	Anti-fouling paint; gasoline spills; effect of River Besòs storm plume; dredging entrance of port; pollution from port restaurants and bars
	EMSSA‡ (Private sector)	River Besòs wastewater treatment plant management	Contacted: no reply	

† CLABSA: Clavegueram de Barcelona, Sociedad Anónima

‡ EMSSA: Empresa Metropolitana de Sanejament, Sociedad Anónima

The quality of the water is affected most significantly during storms. Barcelona has a combined sewer network which means that sewage and surface runoff are collected in a single system. During dry conditions the sewage is pumped to the wastewater treatment plant (WWTP), treated and then pumped far offshore, away from the beaches of Barcelona. However, during rainstorms, the wastewater treatment plants are unable to deal with the sudden increase in volume of mixed sewage and surface runoff. The combined sewer overflow (CSO) is therefore released directly into the coastal water by the beaches of Barcelona. To mitigate this problem, Barcelona has constructed many large underground empty tanks which can collect mixed rainwater and sewage until the storm has passed and then pump the water to WWTP. However the capacity of stormwater collectors is often insufficient to temporarily store this water for later treatment. This results in large quantities of untreated wastewater being released into the coastal waters. Additionally, a plume of organic detritus often forms at the river mouth due to the high density of sediments carried by the increased discharge of the river. Occasionally the untreated wastewater can cause harmful bacteria levels in the water to exceed established safety levels obliging the beach authorities to temporarily prohibit bathing. Even if the maximum allowable limits are not exceeded, many beach users prefer not to

bath due to the discolouration of the water caused by sediment disturbance, the river plume, or increased primary production. Reduced use of the coastal water (either by regulation or personal choice) influences the beach users decision whether to stay at the beach or to leave, thus affecting the revenue received by the bars and restaurants on the beach front. The contractor responsible for maintaining the sewerage network and the stormwater collectors - Clavegueram de Barcelona, Societed Anónima (CLABSA) - chose not to attend the first stakeholder meeting, but the scientific team thought they would participate in later meetings. The hypotheses for this issue are that the stormwater collectors reduce the amount of harmful bacteria and increase water clarity in the beach water following combined sewer overflows; increasing the capacity of the stormwater collectors would further increase the water quality (fewer harmful bacteria and improved water clarity); and an improvement in water quality would increase the recreational appeal of the beaches. A map of the study site is below (Fig. 8).

### 2.3 System Design

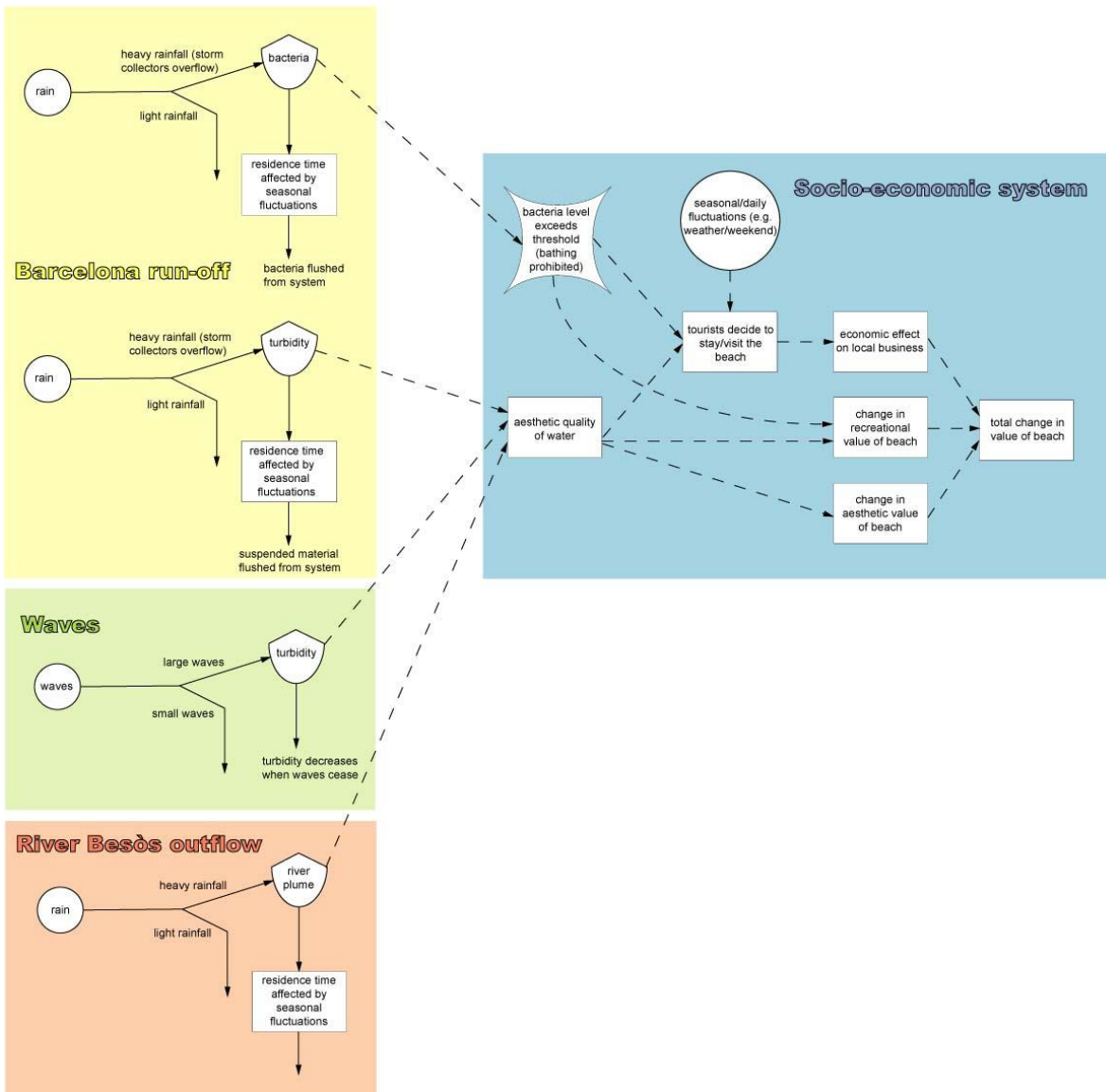
The scientific team determined that it had sufficient data and expertise to analyse the dysfunction highlighted during Issue Identification. So formally it was decided that the issue to be investigated would be “the effects of changes in water quality on the aesthetic and recreational services of the Barcelona beaches”. Water quality was defined in terms of aquatic pathogenic organisms and water clarity, using faecal coliforms and suspended solids as indicators, respectively. Apart from combined sewer overflow events, other important factors that affect coastal water quality include one or more of the following factors: re-suspension of sediment caused by waves, inputs from local rivers, inputs from the local wastewater treatment plant, and the flushing rates of the beaches. Neither the stakeholders nor the scientists viewed phytoplankton as having a significant effect on water clarity. Existing mitigation methods include the output of the wastewater treatment plant channelled through an underwater pipe at a distance of three km from the beaches (whereas before it was much nearer) and the use of stormwater collectors to reduce combined sewer overflows.

The scientific team also wanted to investigate the impact of this issue on the economic component of the system. It was not obvious whether there would be a clear impact of changes in water quality on the revenues of businesses near the beach. Therefore it was decided an additional assessment would also be undertaken using non-market valuation techniques (Chapter 2.4.5.2). There was an initial reluctance to use non-market techniques for the economic evaluation due to the difficulty involved in explaining the results to stakeholders unfamiliar with the methodology.



The scientific team built an initial conceptual model of the issue (Fig. 7). The model is divided into different sub-sets on the basis that there is limited interaction between them and could be viewed as separate sub-models. The SAF recommends constructing hierarchical models so that a user can understand the system as a whole when they first see the model. If they choose to, they can then investigate each section to understand the dynamics of each sub-model. The coloured background distinguishes these sub-models and could be implemented in the modelling software (ExtendSim) in this way.

Fig. 7: Initial conceptual model of the *identified issue* in the SPICOSA application



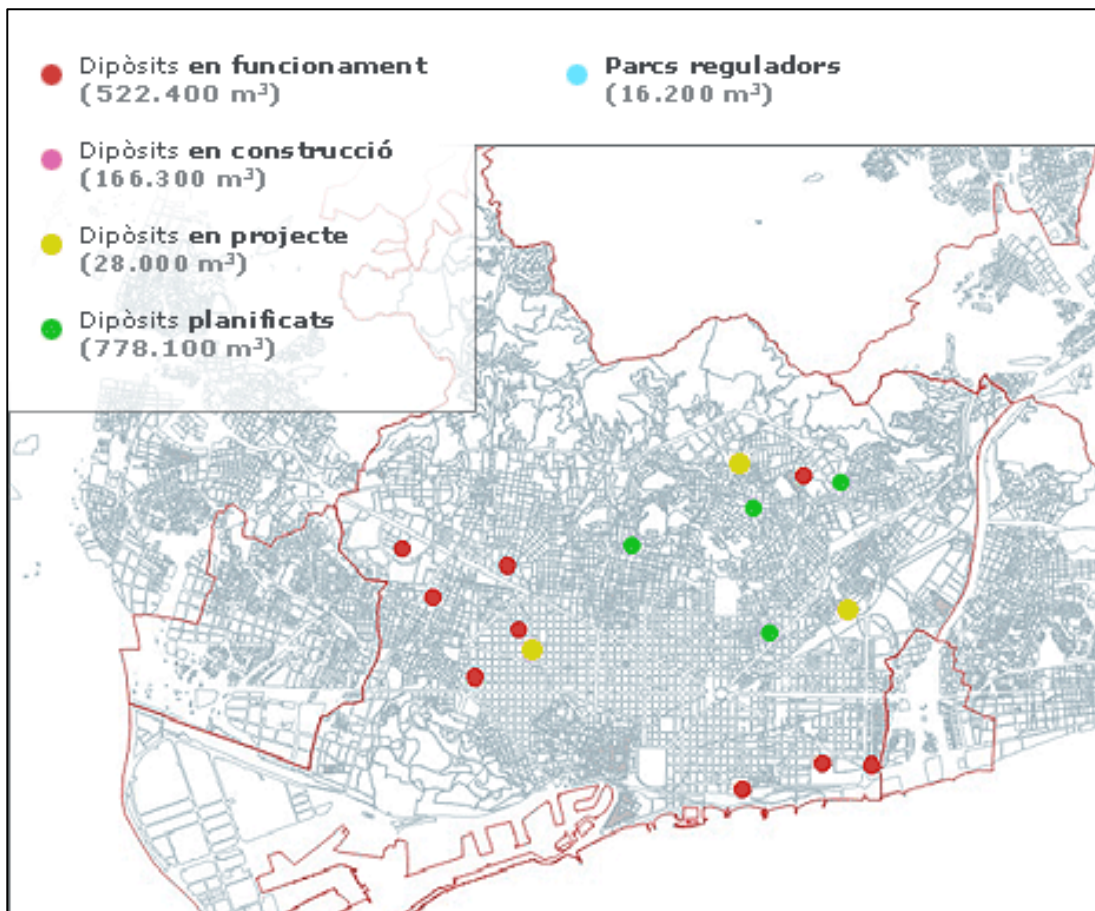
In the conceptual model, solid line arrows indicate flows of energy and matter and dotted line arrows indicated the flow of information or money. Odum symbols (Odum 1971, 2002, Odum and Peterson 1996) are used to indicate how flows of matter and energy are represented. The study-site found that this symbol-set was not very appropriate for displaying interactions in the socio-economic system, and therefore regular rectangles were used instead. Although not explicitly shown in the model, trans-boundary exchanges are marked by the circular symbol (input) and a vertical downward-point arrow (outflow).

A map of the study site is shown in Fig. 8, indicating the six beaches of Barcelona which are directly affected by the combined sewer overflows, and occasionally by the River Besòs plume and the WWTP (depending on meteorological conditions). The boundaries of the system also include the city of Barcelona (runoff via the CSO) and the basin of the River Besòs (river plume carrying suspended solids and bacteria) which are not shown here. Fig. 9 indicates the position of the stormwater collectors within the city.

Fig. 8: Map of the Barcelona beaches affected by combined sewer overflows and by the River Besòs. The beaches are (1) Andrea Doria; (2) Hospital del Mar; (3) Nova Icària; (4) Bogatell; (5) Mar Bella; and (6) Nova Mar Bella. The map also indicates the position of the CSO outlets (\*) and the River Besòs (R). (Google Earth, Cartographic Institute of Catalonia)



Fig. 9: Position of the stormwater collectors in Barcelona (CLABSA). (Red indicates the collectors which are currently functioning; pink are collectors currently being built; yellow are collectors confirmed to be built; and green are those collectors which are in the planning stage)



The primary indicators of the social-ecosystem are:

- Water clarity (both qualitative - “Transparent”, “Turbid” and “Very turbid”; and qualitative - suspended solids  $\text{kg m}^{-3}$ )
- Bacteria (faecal coliforms - coliform forming units (cfu)  $100 \text{ mL}^{-1}$ )
- Revenues of local businesses (Euro per year)
- Number beach users (Individuals per year)
- Recreation and aesthetic value of beach using travel cost method (€ per year)

(Further details of each indicator are described in Chapter 2.4 *System Formulation*.)

The possible management options initially chosen by the scientific team as relevant to the issue are:

- Increase storm collector capacity to reduce untreated waste entering the coastal waters
- Change the treatment type of the WWTP
- Change the position of the wastewater discharge pipe
- Accept that the river plume and discolouration of the water is part of a natural process and persuade the beach users that the water is safe to enter in such conditions
- Take no action. Accept that the value (restaurant and bar revenues and non-market valuation) lost during the storms is not sufficient to warrant investment in rectifying the issue.

## 2.4 System Formulation

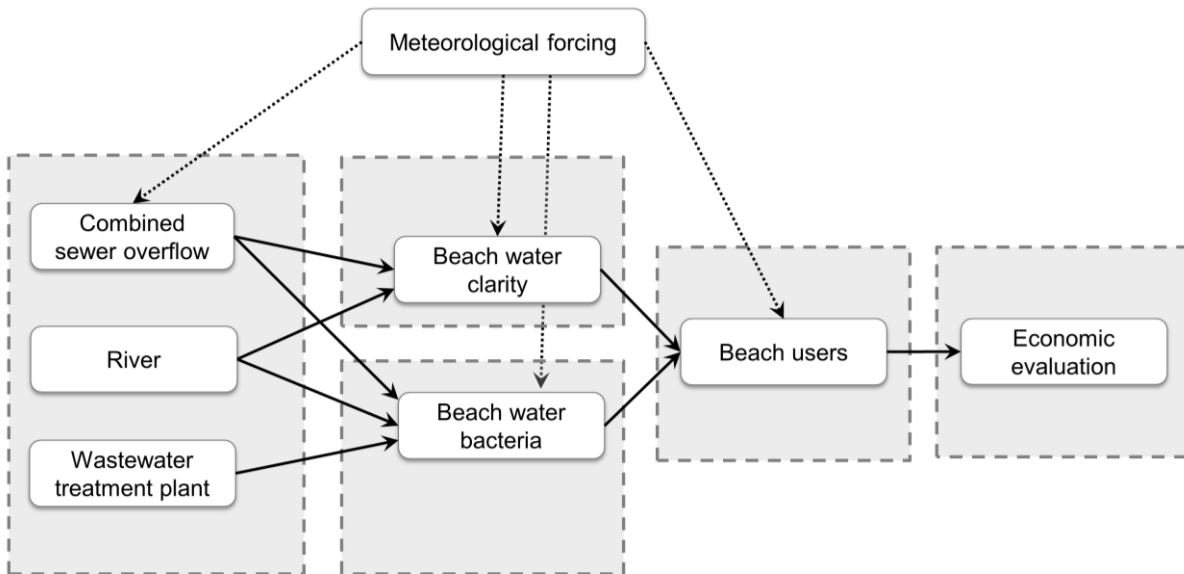
The scientific team did not have access to an existing model which could analyse the various components identified in *System Design* and the conceptual model. Therefore a model was constructed using the methodology outlined in the Systems Approach Framework. It should be emphasised here the SAF advocates constructing a model that can be understood by stakeholders, at least conceptually when displayed at the highest hierarchical level. The SAF does not recommend constructing extremely accurate sub-models if it does not improve the overall functioning of the entire model. The idea of the model is to capture the basic functioning of the whole social-ecosystem, so that it can be used as a tool for deliberation between the stakeholders.

The conceptual model in System Design (Chapter 2.3) was redesigned following consultation with the scientific team to emphasise the two separate indicators of water quality – beach water clarity and bacteria (Fig. 10). The final model in the simulating software which was shown to the stakeholders is shown in Appendix IX.

The time-step of the model was set to one day as this is the resolution necessary to be able to evaluate the impact of beach water quality (beach water clarity and beach water bacteria) on the beach users. If the time-step resolution were lower (i.e. weekly or monthly), then the episodic events of combined sewer overflows which only last a day would be missed. The time-per-step was set to 0.1 so there are ten calculations per day. This is necessary in order to integrate the differential equations in the beach water clarity and beach water bacteria sub-models. A smaller time-per-step increases the number of computations per day, improving the temporal accuracy but at the expense of computational time. Given that the model will be used by stakeholders, long computational times

would inhibit its use during deliberation. The largest input into each sub-model is from the CSO which occurs sporadically so increasing the time-per-step (smaller than 0.1) does not greatly increase the temporal accuracy. Various time-per-steps were used and 0.1 was considered a balance between accuracy and computational time.

Fig. 10: Redesigned conceptual model in the SPICOSA application



The sub-models and connections between them are shown in the conceptual model and each will be analysed in turn below. A table of all the inputs of the model can be found in Appendix III; a table of all the scenario options in Appendix IV; and a table of the symbols and units in each sub-model in Appendix V.

#### 2.4.1 Principal drivers sub-model

The principal driver in the model is the meteorological forcing input data. This feeds into three other sub-models (*Beach water clarity*, *Beach water bacteria* and *Beach users*) as well as the *Combined sewer overflow* (CSO) model described below (Chapter 2.4.1.1). Another driver is the *River* which links to the *Beach water clarity* and *Beach water bacteria* sub-models (daily flow of the local River Besòs). Finally there is the urban wastewater treatment plant (WWTP) that under normal conditions does not release any (treated or untreated) wastewater into the beach water as there is an underwater pipe in which the treated wastewater is pumped far offshore away from the beaches.

However, there have been occasions in which the pumping station has failed and the treated wastewater is released directly into the water near the beaches. The outflow of the WWTP is changeable in the scenario options. The options are:

- $0 \text{ m}^3\text{s}^{-1}$  (normal conditions - when the WWTP pump is functioning the wastewater is pumped far offshore)
- $4.17 \text{ m}^3\text{s}^{-1}$  (the pump fails and the waste water is released to the beaches at a standard flow rate)
- $6.26 \text{ m}^3\text{s}^{-1}$  (the pump fails and the waste water is released to the beaches at 150% of the standard flow rate)
- $8.34 \text{ m}^3\text{s}^{-1}$  (the pump fails and the waste water is released to the beaches at 200% of the standard flow rate)

On each time-step, the WWTP sends a value of daily volume of (treated or untreated) water to the Beach water bacteria sub-model.

#### 2.4.1.1 Combined sewer overflow sub-model

As previously described, the company responsible for maintaining the sewer system and operating the stormwater collectors in Barcelona chose not to participate in this SAF application. Therefore we did not have access to their models nor to the exact functioning of the system. We could only hypothesize how the sewer system and stormwater collectors affected CSOs, so the model was constructed using the following simplifications. Rainwater ( $P$ ) falls on the drainage basin ( $B$ ) of Barcelona and enters the combined sewer system. A certain percentage ( $D$ ) cannot be directed towards the stormwater collectors due to geographical limitations (i.e the collectors are situated further inland than the location of the rainfall), and so is released directly ( $W_d$ ) into the beach water. (The drainage basin ( $B$ ) is measured in  $\text{m}^2$  so rain is converted from  $\text{mm}$  to  $\text{m}^3$ ):

$$W_d = D \times \frac{P}{1000} \times B$$

The rest of the surface runoff in the combined sewer is sent to the stormwater collectors ( $W_c$ ). If the combined sewer water exceeds the capacity of the collectors ( $C$ ), the excess is also released into the beach water:

$$W_c = (1 - D) \times \frac{P}{1000} \times B$$

So the total sewer water ( $W_t$ ) released to the beach water per day is:

$$W_t = W_d + W_c - C \quad (\text{where } W_c - C \text{ is always non-negative})$$

A table of inputs for this model can be found in Appendix III. The current capacity of the stormwater collectors ( $C$ ) is  $5.2 \times 10^5 \text{ m}^3$  but this is currently being constructed and would increase capacity to  $6.9 \times 10^5 \text{ m}^3$ . Additional collectors have been confirmed ( $7.2 \times 10^5 \text{ m}^3$ ) and the sewer company intends to increase it further ( $14.9 \times 10^5 \text{ m}^3$ ) once permission has been granted (CLABSA n.d.). The change in stormwater capacities can be run as alternative scenarios within the model to analyse the impact of these possibilities (see Appendix IV).

The percentage of CSO that goes directly to the beach water ( $D$ ) was not known by the scientific team. Therefore this value was set as a variable within the model and can be changed during a scenario analysis to ascertain the impact it would make on the other sub-models in the system.

On each time-step (day), the Principal drivers sub-model sends the volume of CSO water ( $W_t$ ) to both the Beach water clarity and the Beach water bacteria sub-models. Note that the CSO model outputs only once per day (rather than on every time-per-step).

#### 2.4.2 Beach water clarity sub-model

The beach water clarity sub-model is repeated six times, one for each beach in the study zone, and calculates the concentration of suspended solids ( $S_T$ ) at each time-step. The basic model is a first-order differential equation as recommended during the SPICOSA project and often used in box models of suspended solids (Håkanson et al. 2004). The indicator within this sub-model was chosen to be suspended solids as observed data for the beach water, CSO and river use the same metric. We considered converting this to a Secchi depth but seeing as most of the beach water observations were qualitative, we decided the output of the model should also be qualitative, as the stakeholders were more familiar with this metric.

There are three positive inputs: suspended solids from CSOs ( $S_C$ ), suspended solids from the river ( $S_R$ ), and re-suspension of sediment caused by waves ( $S_W$ ). At each time-step the suspended solids settle on the seabed ( $S_S$ ) or are dispersed via the wind ( $S_Q$ ).

$$\frac{d}{dt} S_T = S_C + S_R + S_W - S_T(S_S + S_Q)$$

Concentration of suspended solids during CSO events was collected by Suárez and Puertas (2005) for one of the CSO outlets flowing into the beach water in Barcelona. The data was analysed and the relation between CSO volume and suspended solids was found to be logarithmic above a certain threshold ( $R^2 = 0.78$ ) and directly proportional below. In the absence of more accurate data, the total CSO water ( $W_t$ ) entering each of the beaches is divided evenly among the six beaches with volume ( $V$ ). Suárez and Puertas (2005) found that there was no identifiable first-flush<sup>1</sup> effect in Barcelona.

$$\frac{1}{6} W_t < 38000 \Rightarrow S_C = 0.0006 \times \frac{1}{6} W_t \times V^{-1}$$

$$\frac{1}{6} W_t \geq 38000 \Rightarrow S_C = 13.917 \times \log_e \left( \frac{1}{6} W_t \right) - 124.497 \times V^{-1}$$

Data was limited regarding how the concentration of suspended solids in the river Besòs changed depending on flow rate ( $F_R$ ). Huertas et al. (2006) analysed the flow rate from 2001-2003 and recorded the concentration of suspended solids when the flow rate was a maximum, minimum and the average. The relation between this data can be expressed as a power regression ( $R^2 = 0.97$ ):

$$S_{R(\text{conc})} = 12.364 \times F_R^{0.5123}$$

(where  $S_{R(\text{conc})}$  is the concentration of suspended solids in mg/L for a given flow rate  $F_R$  ( $\text{m}^3 \text{s}^{-1}$ ))

This relation is partly corroborated by studies in other regions which reveal a similar power regression relation between flow rate and suspended solids but this can depend on the type of hysteresis predominant in the area and time of year (Asselman 1999). This expression (total suspended solids per flow rate) is multiplied by the flow rate ( $F_R$ ) (converted to daily outflow) to calculate the total suspended solids in the river that could arrive to the beach each day. This is then converted to a concentration in the beach water (by dividing by volume of beach water ( $V$ )), and then multiplied by a wind function ( $R_w$ ). The wind function determines what percentage of the river arrives to each beach (Appendix VI). For example, if the wind pushes the river outflow away from the beaches then the value of  $R_w$  is zero. The final equation is:

$$S_R = F_R \times 1.0683 \times F_R^{0.5123} \times V^{-1} \times R_w$$

---

<sup>1</sup> The first-flush effect is where pollution load is greater during the initial CSO volume due to sediments and pollutants removed from the dry sewers



The calculation of re-suspension of sediment caused by waves ( $S_w$ ) is calculated by using standard equations taken from Soulsby (1997) once per day (Appendix VII).

The parameter of  $S_s$  is a constant that indicates the rate at which suspended solids are removed from the beach water, primarily by settling on the seabed. The value depends on many complex issues regarding the suspended solid size, beach morphology, currents, wind, and wave. Fugate and Chant (2006) found the settling rate of CSO suspended solids can vary by over an order of magnitude, and is specific to the site and hydrodynamic conditions on the day. Therefore these attributes were combined into this single parameter that was later calculated using the optimiser within the ExtendSim software, in which various values were tested until the output of the model produced results most similar to the observed data (Chapter 2.4.2.1). There is a unique value of  $S_R$  for each beach (Appendix III).

The dispersion of suspended solids by wind ( $S_Q$ ) depends on the direction of the wind ( $Q_d$ ). If the wind is offshore then the suspended solids are dispersed from the beach water more quickly. The rate at which this dispersion occurs depends on the wind velocity ( $Q_v$ ) and an unknown rate ( $S_{Qr}$ ) which was calculated using the software optimiser (Chapter 2.4.2.1).

$$Q_d < 45 \quad \parallel \quad Q_d > 225 \quad \Rightarrow \quad S_Q = S_{Qr} \times Q_v \times \sin\left(\frac{\pi}{180} (Q_d - 225)\right)$$

$$Q_d > 45 \quad \& \quad Q_d < 225 \quad \Rightarrow \quad S_Q = 0$$

#### 2.4.2.1 Optimising unknown parameters in Beach water clarity sub-model

There are two unknown parameters in the Beach water clarity sub-model: the rate at which suspended solids are removed from the beach water, primarily by settling ( $S_s$ ); and a wind dispersions factor parameter ( $S_{Qr}$ ) used in determining ( $S_Q$ ). (Each of the six beaches has its own settling rate, whereas the wind dispersion factor is the same for all beaches). In order to estimate the unknown parameters, various values for each parameter are tested and the model output is compared against observed data. The best estimate parameters are those which minimise the difference (least squares) between the model and observed data. The ExtendSim software has an in-built optimiser in which minimum and maximum values are entered for each unknown parameter, as well as any other constraints (e.g. parameter1 > parameter2). The software user also specifies

how close to “optimum”, the result should be. The most optimum solutions try more combinations of variables, but the process takes longer. When using any optimiser software, it is possible that a sub-optimal solution is returned. Therefore the optimiser was run several times to ensure that the results converged to similar values each time.

There were two sets of data available regarding suspended solids in the beach water. The first was a set of qualitative data collected by the local water authority (ACA), in which each beach was visually inspected and the water clarity given a rating of “Transparent”, “Turbid” or “Very turbid”. Beaches were inspected on average between 1-3 days (during June-September, 2001-2005). The second set of data was quantitative (mg/L) but with a lower temporal and spatial resolution - samples were taken approximately once a month (from 2001-2005) in one of the beaches (Hospital del Mar). (Quantitative data supplied from the PUDEM project financed by the Spanish Ministry of Science and Technology (REN2003-06637-C02)).

The first step in estimating the unknown parameters was to use the optimiser to estimate  $S_s$  (Hospital del Mar) and  $S_{Qr}$ , using the observed data for the beach at Hospital del Mar (the calculated values are in Appendix III). In order to estimate the parameter  $S_s$  for the other five beaches we only had the set of qualitative data. To convert the quantitative data to qualitative data, two parameters were sought which represent the threshold between the three ratings (“Transparent”, “Turbid” or “Very turbid”). The optimiser was used again to estimate these two threshold values, comparing the model output of Hospital del Mar against the quantitative data for the same beach. The values for these threshold parameters were calculated as:

$$\begin{array}{ll}
 S_T < 0.98 \text{ (mgL}^{-1}\text{)} & \Rightarrow \text{"Transparent"} \\
 0.98 \leq S_T < 8.65 \text{ (mgL}^{-1}\text{)} & \Rightarrow \text{"Turbid"} \\
 S_T > 8.65 \text{ (mgL}^{-1}\text{)} & \Rightarrow \text{"Very turbid"}
 \end{array}$$

Finally the values of  $S_s$  (for the other five beaches) were estimated using the optimiser by comparing the output of the beach water clarity model converted to a qualitative value, against the observed qualitative data for each beach. The results of these processes are discussed in System Appraisal (Chapter 2.5.2).

### 2.4.3 Beach water bacteria sub-model

The beach water bacteria sub-model is repeated six times, one for each beach in the study zone, and calculates the concentration of faecal coliforms ( $B_T$ ) at each time-step. The basic model is a first-order differential equation similar to the Beach water clarity sub-model. The indicator for bacteria was chosen to be faecal coliforms, the same as the observed data and used in the European Bathing Water Directive (76/160/EEC).

There are three positive inputs: faecal coliforms from CSOs ( $B_C$ ), faecal coliforms from the river ( $B_R$ ), and faecal coliforms from the wastewater treatment plant ( $B_W$ ). At each time-step the faecal coliforms decay ( $B_d$ ), or are dispersed via the wind ( $B_Q$ ).

$$\frac{d}{dt} B_T = B_C + B_R + B_W - B_T(B_d + B_Q)$$

There was no data specific for faecal coliforms from CSOs ( $B_C$ ) for Barcelona so a fixed concentration rate ( $B_{Cr}$ ), ( $1 \times 10^5$  cfu 100 mL<sup>-1</sup>) was taken from the literature for average CSOs (Metcalf & Eddy 1991). This is a simplification as it is likely that faecal coliform concentration will decrease as CSO flow increases. The outflow of the CSO is divided equally between the six beaches and then converted into a concentration of the beach water.

$$B_C = B_{Cr} \frac{1}{6} W_t V^{-1}$$

Data was limited regarding how the concentration of faecal coliforms in the river Besòs changed depending on flow rate ( $F_R$ ). The relation between stream flow and bacteria concentration is difficult to predict (Eleria and Vogel 2005) so the average observed value was used for 2001-2003 (Huertas et al. 2006) ( $B_{Rr} = \log 4.4$  cfu 100 mL<sup>-1</sup>). This value is multiplied by the flow rate ( $F_R$ ) (converted to daily outflow) to produce the faecal coliforms in the river. This is then converted to a concentration in the beach water (by dividing by volume of beach water ( $V$ )), and then multiplied by a wind function ( $R_w$ ). The wind function determines what percentage of the river outflow arrives to each beach (Appendix VI). The final equation is:

$$B_R = 86400 F_R B_{Rr} V^{-1} R_w$$

Similarly, the faecal coliforms from the WWTP is expressed the same as the river due to its similar geographical position. However, the concentration of the outflow of the WWTP is set as a variable within the scenarios (see inputs in Appendix III). The average concentration of faecal coliforms from WWTPs is  $3 \times 10^6$  cfu  $100 \text{ mL}^{-1}$  for treated water and  $1 \times 10^7$  cfu  $100 \text{ mL}^{-1}$  for untreated water (Metcalf & Eddy 1991). The rate of outflow of the WWTP ( $F_U$ ) is also variable for the scenario analysis. The observed flow of the WWTP in Barcelona is  $4.17 \text{ m}^3 \text{ s}^{-1}$  (2008). However, in the standard “current” scenario the value will be zero as the WWTP outflow is pumped offshore away from the beaches.

$$B_W = 86400 F_U B_{Wr} V^{-1} R_w$$

There was no model available to calculate the decay rate of bacteria ( $B_d$ ) in the coastal waters of Barcelona. Therefore an alternative analysis undertaken in the Black Sea (Yukselen et al. 2003) was used instead. Solar intensity ( $I$ ) has the strongest effect on decay rate during the day ( $k_l$ ), but in the dark ( $k_d$ ), sea temperature ( $t$ ) can also influence the decay rate. Solar intensity is reduced to 20% when there is cloud cover (Luccini et al. 2003). There was no data available regarding cloud cover in Barcelona so rain ( $P$ ) was used as a proxy.

$$P > 0 \quad \Rightarrow \quad I = 0.20 I$$

$$k_l = 0.0337 I + 0.1184$$

$$k_d = \frac{2.3}{-19.92 \log(t) + 79.17}$$

The larger of these two decay rates is converted to a daily decay rate ( $B_d$ ).

$$B_d = 24 \times \text{maximum}(k_l, k_d)$$

The model reads a table of solar intensity and returns a value specific to the month and hour of day ( $\text{cal cm}^{-2} \text{ h}^{-1}$ ) (Appendix VIII).

The dispersion of faecal coliforms by wind ( $B_Q$ ) depends on the direction of the wind ( $Q_d$ ). If the wind is offshore then the suspended solids are dispersed from the beach water more quickly. The rate at which this dispersion occurs depends on the wind velocity ( $Q_v$ ) and an unknown rate ( $B_{Qr}$ ) which was calculated using the software optimiser in the same way as in the Beach water clarity sub-model (Chapter 2.4.2.1), but in this case there is a value of ( $B_{Qr}$ ) for each beach.

$$Q_d < 45 \quad \parallel \quad Q_d > 225 \quad \Rightarrow \quad B_Q = B_{Qr} \times Q_v \times \sin\left(\frac{\pi}{180} (Q_d - 225)\right)$$

$$Q_d > 45 \quad \& \quad Q_d < 225 \quad \Rightarrow \quad B_Q = 0$$

#### 2.4.4 Beach users sub-model

A model was required that could analyse how changes in beach water quality (water clarity and bacteria) affects the beach users, however, no model existed for the beach users of Barcelona. The scientific team proposed comparing suspended solids and bacteria levels on a given day against the number of beach users. A quick analysis revealed there was no correlation, and other factors had a stronger influence on the number of users (such as meteorological data (rain, wind), day of week (there are many more weekend visitors than during the week), and month of the year). It was possible that the water quality did influence the number of visitors but the affect would only be apparent over the medium-long term. A beach user might not want to enter the water because of low water clarity but they would still stay at the beach that day. However, it could influence their opinion to return at a future date. In order to ascertain this, a survey would have to be undertaken – possibly using techniques such as stated preference methods (e.g. Contingent valuation) or revealed preference methods (e.g. Travel Cost Method; Hedonic price analysis). There were not the necessary resources available to undertake such a study within the SPICOSA project, so a model was designed that could incorporate the results of these methodologies in the future, in the case that they were undertaken.

A recent study had used video-analysis techniques to count the number of daily users from three fixed video cameras near two of the beaches of Barcelona (Guillén et al. 2008). The study revealed a nonlinear fit model determining the number of users ( $N$ ) based on the following factors: mean daily air temperature ( $T$ ), daily rainfall ( $P$ ), mean wind speed ( $Q_v$ ), and two predisposition factors due to the day ( $D$ ) and month ( $M$ ).

$$N_{nova\ icaria} = \frac{17.672 T^{1.8069} [(D + 0.001)^{0.8527} + (M + 0.001)^{0.7748}]}{[(Q_v + 0.001)^{0.3351} + 1][(V + 0.001)^{0.0275} + 1]}$$

$$N_{hosp\ del\ mar} = \frac{11.604 T^{1.8920} [(D + 0.001)^{0.9601} + (M + 0.001)^{0.8860}]}{[(Q_v + 0.001)^{0.4211} + 1][(V + 0.001)^{0.3173} + 1]}$$

There was no model available for the other beaches so an average of these two models were used and multiplied by the proportional difference of beach length ( $L$ ). (Nova Icaria and Hospital del Mar have approximately the same length).

$$N_{(other)} = \frac{L_{(other)}}{L_{nova\ icaria}} \frac{14.638 T^{1.8495} [(D + 0.001)^{0.9064} + (M + 0.001)^{0.8304}]}{[(Q_v + 0.001)^{0.3781} + 1][(V + 0.001)^{0.1724} + 1]}$$

The variable “recreational appeal” ( $A$ ) was used to determine the effect of beach water quality on the number of beach users. Initially set to 1, this variable changes depending on the water clarity ( $A_S$ ), the number of beach users (saturation of the beach) ( $A_U$ ), and whether the beach closes because the number of bacteria exceeds the mandatory limit ( $A_B$ ). There also needs to be a factor which increases the recreational appeal when the water quality is “good” and not over-saturated (neither turbid, nor closed due to bacteria) ( $A_G$ ). This is partly a modelling problem (otherwise the recreational appeal could only decrease) and partly based on the idea that a beach will be more attractive to a user if they know that the water quality will be “good” and not over-crowded when deciding which beach to visit. Note that the beach saturation function will limit the number of visitors to a beach in the case that water quality is “good” for a sustained period. The recreational appeal variable ( $A$ ) is then multiplied by the number of users ( $N$ ) in the Guillén et al. (2008) model described above to produce the expected number of beach users ( $N_E$ ).

$$N_E = N \times A$$

$$A_t = A_{t-1} - N_E(A_S + A_B + A_U) + N_E(A_G)$$

If suspended solids in the beach water exceed  $0.98 \text{ mgL}^{-1}$  (the threshold value calculated in the Beach water clarity sub-model as being “Turbid”) then the effect on recreational appeal caused by suspended solids will be a positive undetermined value ( $A_S$ ). The exact value of  $A_S$  is unknown and is user definable (within limits). Changes to  $A_S$  can be adjusted within the model and will be analysed in the scenario analysis.  $A_S$  is zero in the case that suspended solids are less than  $0.98 \text{ mg L}^{-1}$ .

$$S_T > 0.98 \quad \Rightarrow \quad A_S = A_S$$

$$S_T \leq 0.98 \quad \Rightarrow \quad A_S = 0$$

Similarly, if the faecal coliforms exceed the maximum allowable concentration ( $2000 \text{ cfu } 100 \text{ mL}^{-1}$ ), then the beach will be closed to bathing (Bathing water directive 76/16/EEC). The effect this will have on recreational appeal caused by bacteria (beach closure) is also an undetermined value ( $A_B$ ). If faecal coliforms are below the limit then  $A_B$  is zero.

$$B_T > 2000 \quad \Rightarrow \quad A_B = A_B$$

$$B_T \leq 2000 \quad \Rightarrow \quad A_B = 0$$

If the number of beach users exceeds the saturation level of 4 individuals  $m^{-1}$ , then recreational appeal will decrease by an undetermined value ( $A_U$ ), otherwise  $A_U$  is zero<sup>2</sup>.

$$\frac{N_E}{L} > 4 \quad \Rightarrow \quad A_U = A_U$$

$$\frac{N_E}{L} \leq 4 \quad \Rightarrow \quad A_U = 0$$

In the case that all three of these values ( $A_S$ ,  $A_B$ ,  $A_U$ ) are zero, (i.e. suspended solids are below 0.98  $mgL^{-1}$ , faecal coliforms are below 2000 cfu  $100 mL^{-1}$ , and beach users are less than 4 individuals  $metre^{-1}$ ) then recreational appeal will increase by an undetermined factor ( $A_G$ ).

$$A_S = A_B = A_U = 0 \quad \Rightarrow \quad A_G = A_G$$

$$A_S + A_B + A_U > 0 \quad \Rightarrow \quad A_G = 0$$

Each of these four factors ( $A_S$ ,  $A_B$ ,  $A_U$ , and  $A_G$ ) is then multiplied by the number of beach users that day ( $N_E$ ) to calculate the final change in recreational appeal for that day. Therefore if there are few people on the beach there is little effect on the recreational appeal. For example if there is a high concentration of suspended solids (above the threshold), but there are only a few beach users (e.g. during winter), it will not greatly affect the recreational appeal.

The four undetermined values are adjustable in the model, and examined in System Appraisal (Chapter 2.5.4). In reality these values will be constant (for the beach user population as a whole), but need to be determined using surveys or other techniques as discussed in the introduction of this sub-model.

The model repeats this analysis for all six beaches and outputs the expected number of beach users ( $N_E$ ) to the economic evaluation sub-model.

#### 2.4.5 Economic evaluation sub-model

There are two parts of the economic evaluation sub-model. First there is the market valuation component in which real goods and services are exchanged and the value is reflected within the balance between the costs of production and what people are willing to pay. In this case study, the

---

<sup>2</sup> According to Alemany (1984), beach saturation level is approximately 5  $m^2$ /user. Assuming users only use the 20 m nearest to the shoreline (Valdemoro and Jiménez 2006), this is equivalent to 4 users/m

goods and services which will be most affected by the beach water quality will be the bars and restaurants in the near vicinity of the beach. If the quality of the beach water is high, then people will be more likely to visit the beach and a certain percentage will also visit the bars and restaurants, purchasing goods, and increasing the employment within these establishments.

The second component of the economic evaluation sub-model uses non-market techniques to reveal the value of the services offered by the beaches. There is no entrance fee to the beach so the value of the beach cannot be calculated using market techniques. There are various methods which can be used to place a monetary value on ecosystem services which are divided into two categories – *stated preference* and *revealed preference* methodologies. Stated preferences methods such as contingent valuation directly ask what people are willing to pay for an ecosystem service. In contrast, revealed preference methods examine the value of a market good that is linked with the ecosystem service in order to estimate the willingness-to-pay. These include *hedonic pricing* and the *travel cost method* (TCM).

#### 2.4.5.1 Revenues of beach bars and restaurants

A survey was undertaken by the scientific team in which the number of restaurants, restaurant-bars and bars in the near vicinity of the beach, their occupancy, and average cost per meal were counted. For this survey the establishments that were included as being in the “near vicinity” were those directly on the beach or those on the promenade of the beach. The owners were asked directly regarding revenues, employment and customer turnover but most were unwilling to participate and so estimates were made. The percentage of restaurant and bar clients that come from the beach ( $N_b$ ) was estimated. This value is multiplied by the occupancy of the beach (Expected number of visitors ( $N_E$ ) divided by beach saturation limit ( $4 \text{ users m}^{-1}$ ) multiplied by length of beach ( $L$ )) so that on busy beach days there will be a higher number of visitors to the nearby bars and restaurants, and vice versa. This is then aggregated together with the number of bar and restaurant clients who have not come from the beach ( $1-N_b$ ). The total number of beach users (as a percentage) is then multiplied by the expenses ( $P_i$ ), maximum seating occupancy of the establishment ( $O_i$ ) and the seat turnover ( $T$ ) - the number of clients served for each available seating place over the day. This is repeated three times for each type of establishment  $i$  (restaurants; bar-restaurants; and bars).

$$R = \sum_{i=1}^3 T \times O_i \times P_i \left[ N_b \times \min\left(1, \frac{N_E}{4L}\right) + (1 - N_b) \right]$$



The estimated values of  $O$  and  $P$  for each type of establishment are shown in Appendix III. There is no data regarding the seat turnover specific to the bars and restaurants on the beach front in Barcelona. However, a report for the National Restaurant Association (USA) shows that the average daily seat turnover is 1.6 and the highest value is 2.0 (National Restaurant Association and Deloitte 2010). We chose to use a fluctuating value for seat turnover where the value would be 2.0 in the summer and decreases to 1.5 during winter using the following equation, where “*timestep*” is the time-step of the model. (Note that the model must start on January 1<sup>st</sup> for the equation to be correct.)

$$T = -\frac{1}{4} \cos\left(\frac{\pi}{180} \frac{360}{365} \textit{ timestep}\right) + 1.75$$

#### 2.4.5.2 Travel-cost method

Given that the percentage of visitors from the beach to the nearby restaurants and bars was estimated to be low (5%), the impact of changes in the water quality on revenues was also expected to be low. In order to try and capture the change in value of the beaches, a non-market methodology was also applied. The travel-cost method (TCM) of economic valuation is a widely used methodology using revealed preferences (Bell and Leeworthy 1990, Ward and Beal 2000, Font 2000, Parsons 2003, Blakemore and Williams 2008, Martín-López et al. 2009). The basic premise is that users incur time and expenses in travelling which represents the “price” of access to the beach. The users’ willingness-to-pay can be estimated based on the number of visits they make at differing travel costs. The methodology used in the model was taken from Ward and Beal (2000). In order to fully understand the impact of changes in environmental quality, it is common for a contingent valuation study to estimate the change in number of visits by each tourist for a hypothetical change in environmental conditions. There were no resources within the project to undertake such a survey and so the changes in visitors were assumed to affect each group of beach users (i.e. where each visitor originates from) proportionally the same. If more specific information becomes available, it would be simple to update the input data in the model in order to update and improve the results.

The first step in applying the methodology is to determine a set of zones of origin for each of the tourists. A survey undertaken by Department of Parks and Gardens (Barcelona council) in 2005 reveals that the majority of visitors live in one of four zones: Barcelona; the metropolitan area of Barcelona (Àrea Metropolitana de Barcelona - AMB); Catalonia; and Spain. There are comparatively very few international visitors to the beaches of Barcelona. The percentage of users from each zone is shown in Appendix III, but the majority are from Barcelona (79.4%). The number of residents in

each zone is also required (also shown in Appendix III). The final step in terms of data collection is calculating the expenses each user makes in visiting the beach. These were estimated by the scientific team.

The basic demand function is calculated using these data where  $x$  is the travel cost per person,  $y$  is the visit rate (i.e. the number of visitors from a given zone divided by the population of that zone) and  $n$  is the number of zones. A visit rate curve is calculated by regression of travel costs against visit rate. In this case the visit rate curve takes the exponential form due to the high number of nearby beach users and low number of visitors from afar (as opposed to a linear visit rate function). See Chapter 2.5.5 for the value of coefficient of determination ( $R^2$ ).

$$y = ae^{bx}$$

The parameters  $a$  and  $b$  are therefore calculated:

$$B = \frac{n \sum xy - \sum x \sum y}{n \sum x^2 - (\sum x)^2}$$

$$b = B$$

$$A = \frac{\sum y - b \sum x}{n}$$

$$a = e^A$$

Hypothetical changes to the costs per visit are introduced to this equation to calculate changes in visitors. In the case of the model the following additional hypothetical fees (in euros) were added to the travel costs already assumed by visitors for each zone (10, 20, 50, 80, 100, 150, 200, 250, 300, 400, 450, 500, 1000). The sum of number of visitors per zone is then regressed against these differing levels of costs (travel costs plus hypothetical entry fee) in order to create a demand curve for the beach. The demand curve takes the logarithmic form (and  $A$  and  $B$  are calculated as previously described):

$$y = B \log_e(x) + A$$

The consumer surplus is calculated by measuring the area under the demand curve and can be considered the willingness-to-pay for all users.

$$\int B \log_e(x) + A = x (A + B \log_e(x) - b) + constant$$

The limits of the integral (the area under the curve) are calculated from  $x \rightarrow 0$  to  $e^{-\frac{A}{B}}$ .

The consumer surplus is calculated every day and aggregated for a yearly total.

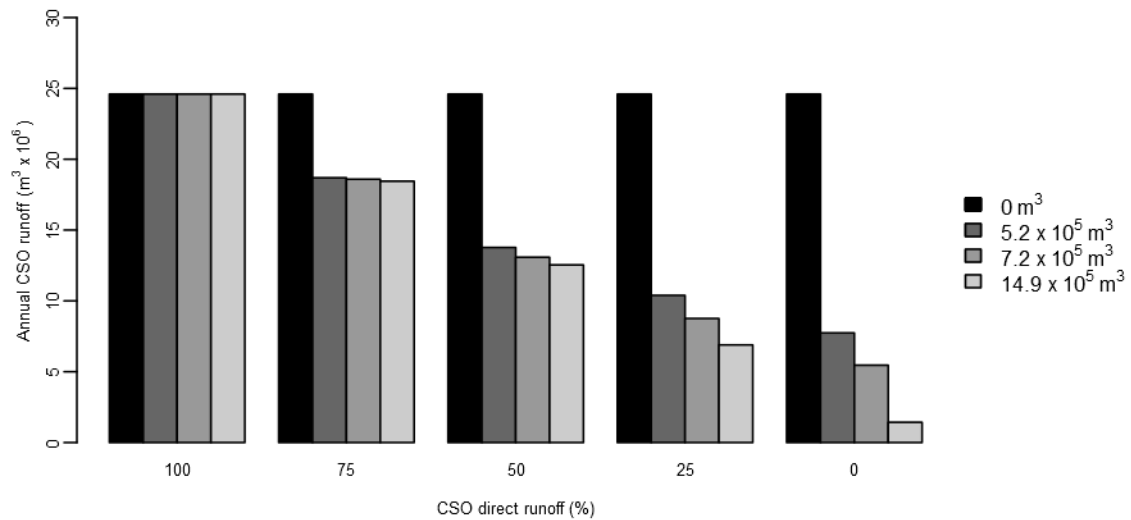
## 2.5 System Appraisal

### 2.5.1 Principal drivers sub-model

The principal drivers sub-model mainly consists of the input data for the rest of the model, such as meteorological data and river flow. The only modelled component of the sub-model is the calculation of the volume of combined sewer overflow entering the beach water. Given that the stakeholder who manages the sewer network and stormwater collectors chose not to participate in the SAF application, a rough approximation was used, as described in Chapter 2.4.1.1. The key unknown parameter in the model (at least unknown by the author) is the percentage of CSO runoff which flows directly into the beach water without being pumped to a stormwater collector. This is partly a geographical problem, as most of the stormwater collectors are further inland and uphill from the beaches, and is partly a management decision. An additional problem with heavy rain in Barcelona is that the roads can become flooded creating a dangerous situation for motorists and especially motorcyclists. The objective in such circumstances would be to remove the runoff water as quickly as possible from the city to either the stormwater collectors or to the beach water, whichever is quickest. Fig. 11 shows the annual (averaged over four years from 2002-2005) CSO runoff depending on the stormwater collectors total capacity (which is currently  $5.2 \times 10^5 \text{ m}^3$ ) and the unknown direct runoff percentage. It would be impossible for all of the CSO runoff to be directed to the stormwater collectors so the 0% value is just figurative. For a 75% and 50% direct runoff value, there is not much benefit in increasing the stormwater capacity from the current level ( $5.2 \times 10^5 \text{ m}^3$ ) to either the confirmed increase in capacity ( $7.2 \times 10^5 \text{ m}^3$ ) or to those in the planning stage ( $14.9 \times 10^5 \text{ m}^3$ ). The benefits in increasing stormwater collector become more apparent only if the direct runoff can be reduced to 25% or lower. This result has implication of the cost-benefit analysis examined during the scenario analysis in Chapter 2.6.1. It is likely that the real percentage of direct runoff is between 25-50% given the position of the stormwater collectors.

For the optimization process used in the beach water clarity and beach water bacteria sub-models to calculate the unknown parameters, a value of 50% direct runoff was used. In the case that this is not true, then the optimizer would calculate different values for the unknown parameters. However, until more data is available, then the real value cannot be confirmed.

Fig. 11: Annual CSO runoff depending on stormwater collector capacity and direct runoff

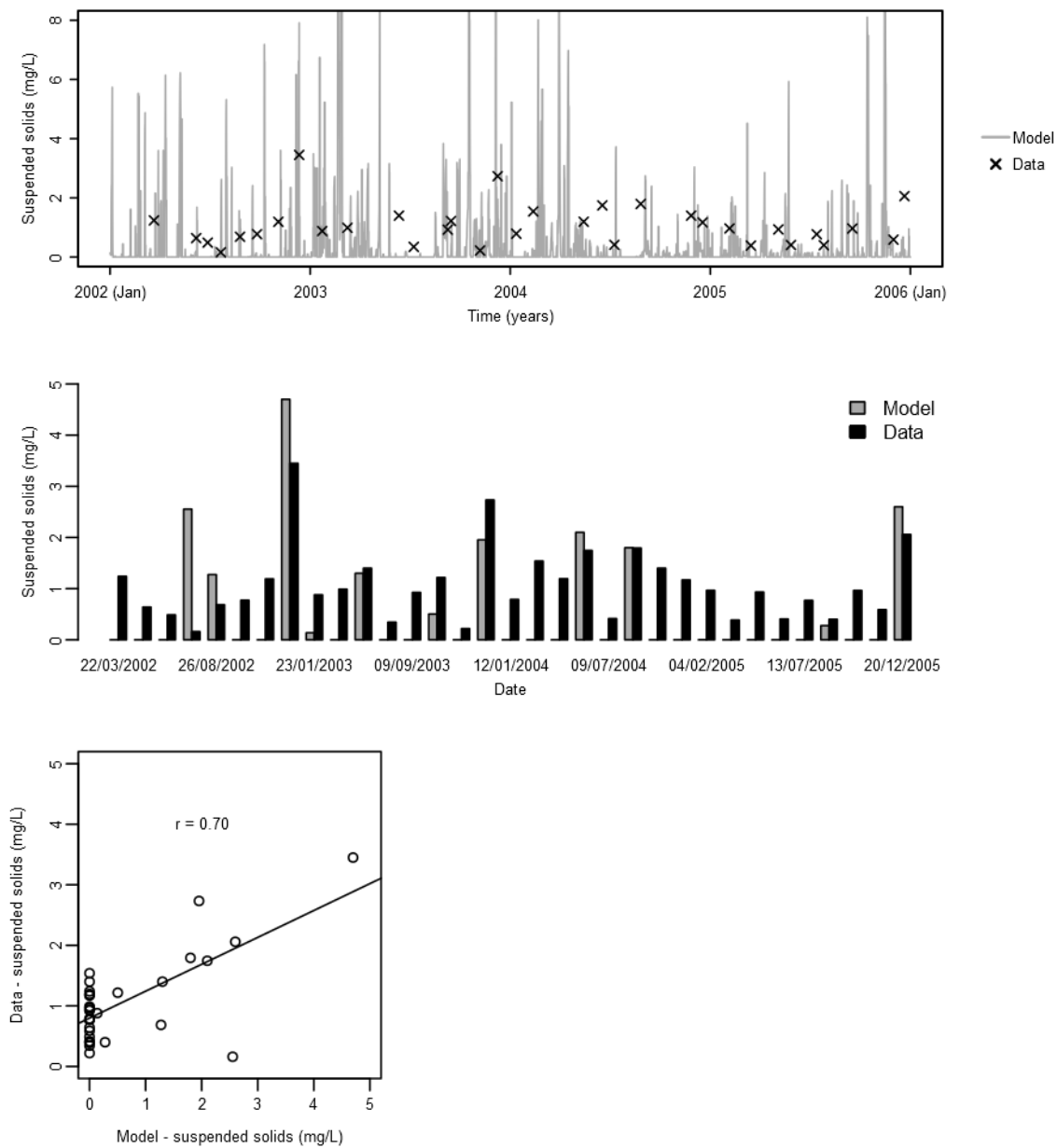


### 2.5.2 Beach water clarity sub-model

Quantitative data was only available for one of the beaches (Hospital del Mar). Fig. 12 shows the comparison of the model output and the observed data. (The sewer network parameters used are those that represent the current situation: 50% direct runoff; stormwater collector capacity of  $5.2 \times 10^5 \text{ m}^3$ ).

The model produces values in the same order of magnitude to those observed. If only the dates which have data points are plotted against the model (for that day), it can be seen that the model performs relatively well when suspended solids are above 1 mg/L. However below this observed value, the model often produces a value of zero. It seems the model is unable to predict low values of suspended solids but is more accurate with higher values. The correlation coefficient between the model and observed data is  $r=0.70$  (Fig. 12).

Fig. 12: Suspended solids (mg/L), model vs data (Hospital del Mar)

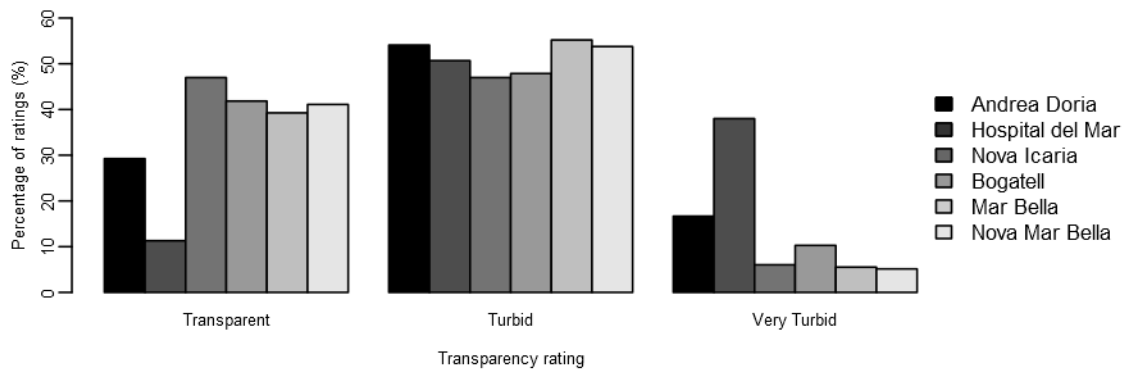


The prediction accuracy of the beach water clarity sub-model for qualitative data is shown in Table 3. The model performs well at low suspended solid concentrations (“Transparent”) but quite poorly at higher concentrations. There are relatively few days given a “Very turbid” rating. (For the years 2002-2005, excluding Hospital del Mar, only 5-15% of all ratings were “Very turbid”. Fig. 13). For this reason, the model is unable to capture these events with good accuracy. The qualitative model also performs badly for Hospital del Mar, which is not surprising given that it receives a much greater number of “Very Turbid” ratings than the other beaches (Fig. 13).

Table 3: Prediction accuracy of beach water clarity sub-model (qualitative data)

Beach	Transparent < 0.98 mg/L	Turbid 0.98 < S < 8.65 (mg/L)	Very Turbid > 8.65 mg/L	Overall
Andrea Doria	96.1	59.3	20.5	64.4
Hospital del Mar	96.4	61.5	10.9	46.8
Bogatell	78.9	71.1	29.2	70.0
Nova Icaria	79.1	72.2	31.3	72.8
Mar Bella	81.3	51.8	26.7	61.9
Nova Mar Bella	81.7	52.9	33.3	63.7

Fig. 13: Percentage of observed turbidity ratings per beach



There is obviously a significant problem in using qualitative data to verify a model because there is no objective value for each of the three turbidity ratings. For example, changes in light conditions (either the time of day of the visual inspection, or cloud cover) can change the aspect of the beach water clarity although the actual suspended solids could be the same. The turbidity ratings were given over many years, and changes to personnel who make the observation could also influence the final rating.

A problem with the model is the lack of data regarding inputs from point sources. Dredging often occurs for beach replenishment and this can reduce water clarity during the process. The relevant data was not available to be used. However, given that beach replenishment tends to occur before the bathing season starts, the overall effect on the recreational appeal of the beach would probably be low anyway.

The impact of the river on beach water turbidity is shown in Table 4. Although a significant amount of suspended solids arrive from the river to the beach water (the total percentage is between 22%

and 36% depending on the beach), the decisive impact this has when the beach water is “turbid” is between 11 and 29% (i.e. in the hypothetical case that the river flow were zero then the beach water would still be “turbid”) and has no influence on the “very turbid” days. The beaches nearer to the river are more greatly impacted by the suspended solids in the river. Due to the lack of quantitative data for suspended solids, it is difficult to assess the accuracy of the river model.

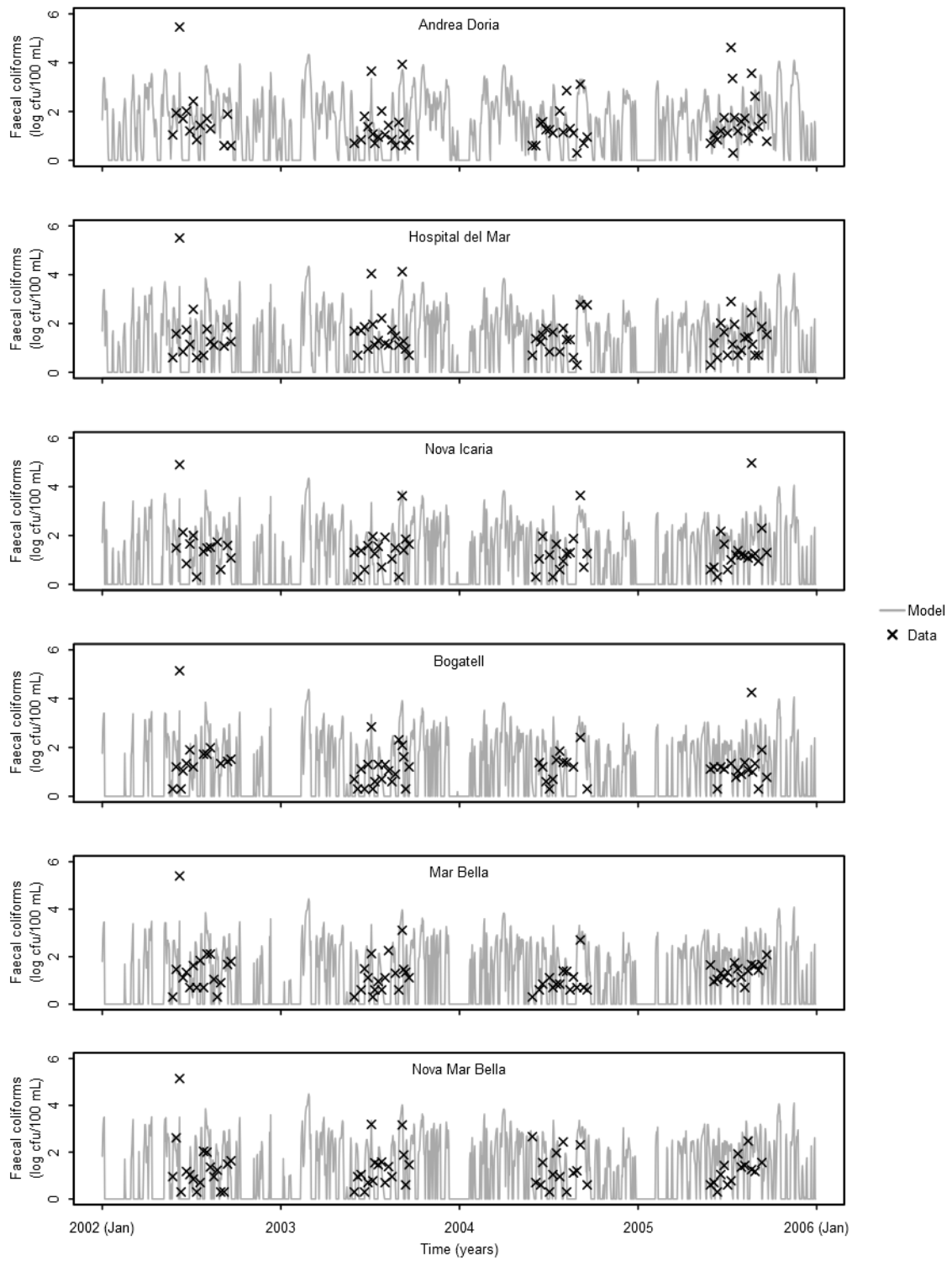
Table 4: Impact of river on beach water turbidity

	Number of bathing days (per year) when water is "turbid"	Number of bathing days (per year) when water is "very turbid"	Percent of suspended sediment from river (per year)	Percent of bathing days river contributes to water being "turbid"	Percent of bathing days river contributes to water being "very turbid"
Andrea Doria	13.28	1.01	22.28	11.37	—
Hospital del Mar	17.02	1.52	29.09	21.10	—
Nova Icaria	12.95	1.01	26.82	18.06	—
Bogatell	13.13	1.07	30.68	22.78	—
Mar Bella	15.18	0.20	33.83	26.27	—
Nova Mar Bella	16.05	0.25	36.14	29.42	—

### 2.5.3 Beach water bacteria sub-model

There was only observed data regarding faecal coliforms during the summer months. This was compared against the model output (Fig. 14). (The sewer network parameters used are those that represent the current situation: 50% direct runoff; stormwater collector capacity of  $5.2 \times 10^5 \text{ m}^3$ ; and no outflow from the WWTP). The model produces values in the same order of magnitude as the observed data. However comparing only the observed data points against the corresponding modelled data (Fig. 15), the correlation is relatively low. The model is unable to recreate the highest observed data points. However this might not be such a problem as long as the model correctly predicts when faecal coliforms are above the threshold when the beach closes - 2000 cfu / 100mL (3.3 log cfu / 100 mL). The actual value is not so important for this model. In these cases, the model is adequate. The difference in actual value could be caused by many factors. For example, when CSO water is released into the beach water, the faecal coliforms will slowly diffuse over the area. The model does not take this delay into account and immediately calculates the concentration assuming an instant diffusion. The observed data could have been collected during this time when the faecal coliforms were concentrated in one area and not fully diluted with the rest of the beach water. This was partially confirmed by the local water authority (ACA) who stated that it was standard practice to collect samples of beach water directly after rain and CSO events, before it has been given time to diffuse. There are also many values which the model states as zero when the observed value is

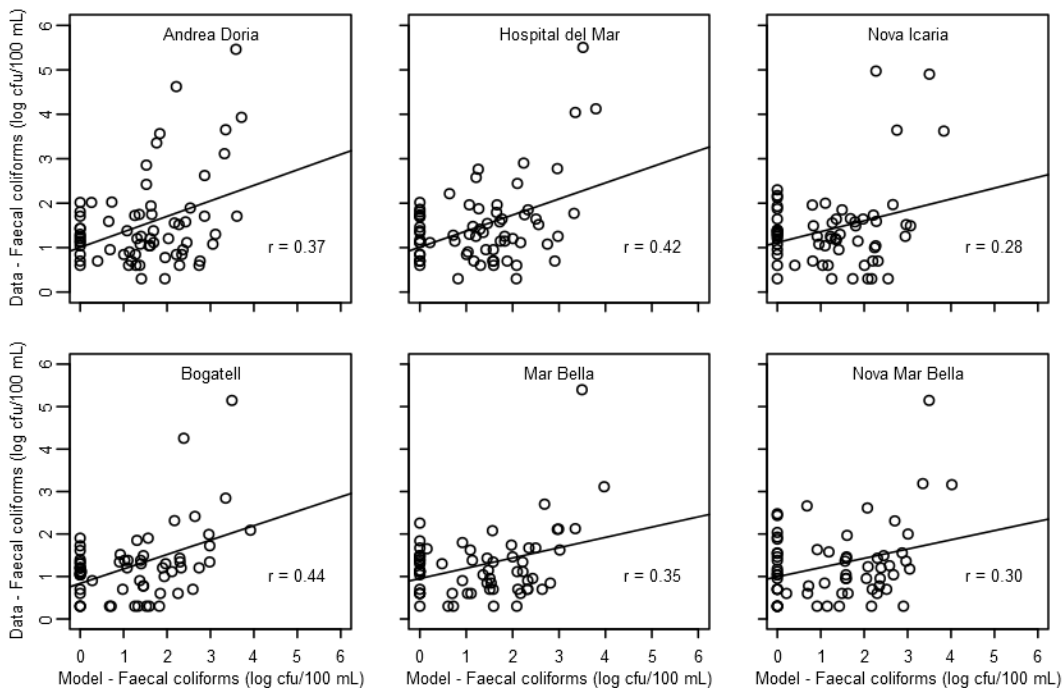
Fig. 14: Model output and observed faecal coliforms (log cfu / 100 mL)





above zero (although low). If there was any rain that day then the model would produce a small value for faecal coliforms. Examining the days when this occurred, there was no rain so there are clearly other sources of faecal coliforms other than CSO and the river. However, these values are low and do not reach the beach closure threshold value and so will have zero impact on the recreational appeal of the beaches sub-model. Possibly the low correlation between the model and data is caused by the decay value used in the model which was taken from a study in the Black Sea (Yukselen et al. 2003). It is likely that the decay rate of bacteria in Barcelona would be different due to changes in salinity and light conditions.

Fig. 15: Correlation between observed data and modelled faecal coliforms (log cfu / 100 mL)



The impact of the river on beach water bacteria is shown in Table 5. A significant amount of faecal coliforms arrive from the river to the beach water (the total percentage is between 9% and 36% depending on the beach). The contribution of the faecal coliforms in the river is decisive as to whether the beach has to close due to exceeding the bacteria limit (2000 cfu / 100 mL) between 10% and 36% of bathing days (i.e. in the hypothetical case that the river flow were zero then the beach would still be closed for exceeding the limit). The beaches nearer to the river are more greatly impacted by the faecal coliforms in the river. In the river model, the concentration of faecal coliforms is fixed and independent of river flow, because there was no data to improve this

approximation. In reality, at higher flow rates, the concentration would probably decrease, which would result in a lower impact on the beach water than the model predicts.

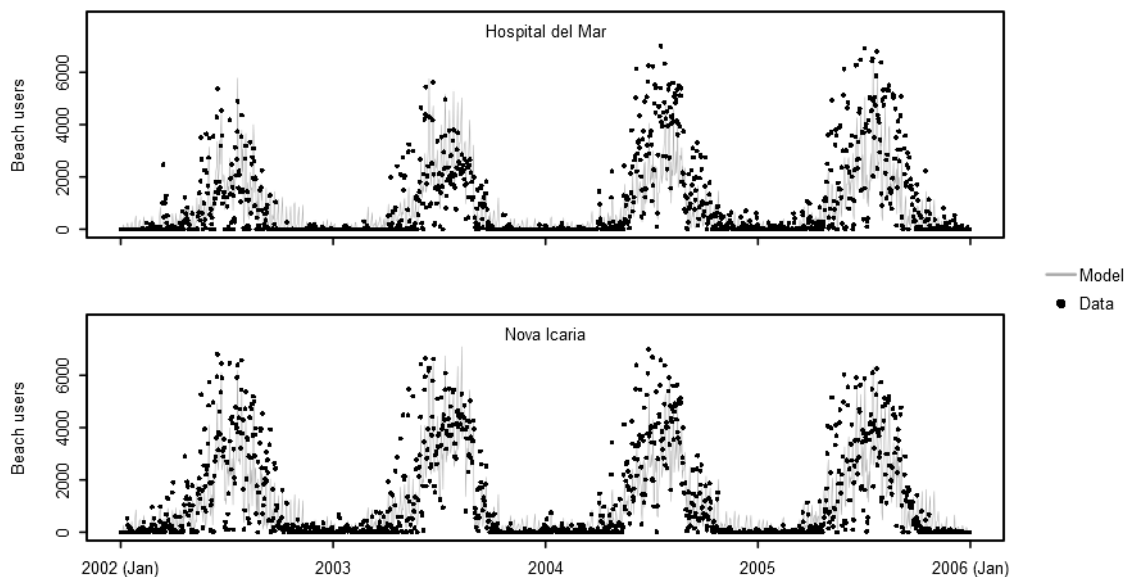
Table 5: Impact of the river on beach water bacteria

	Number of bathing days (per year) faecal coliforms > 2000 cfu / 100 mL	Percent of faecal coliforms from river (per year)	Percent of bathing days river contributes to faecal coliforms > 2000 cfu / 100 mL
Andrea Doria	4.58	9.89	10.46
Hospital del Mar	2.55	18.06	12.94
Nova Icaria	2.13	24.90	22.52
Bogatell	1.65	29.55	26.00
Mar Bella	1.90	33.25	31.26
Nova Mar Bella	2.13	36.33	35.72

#### 2.5.4 Beach users sub-model

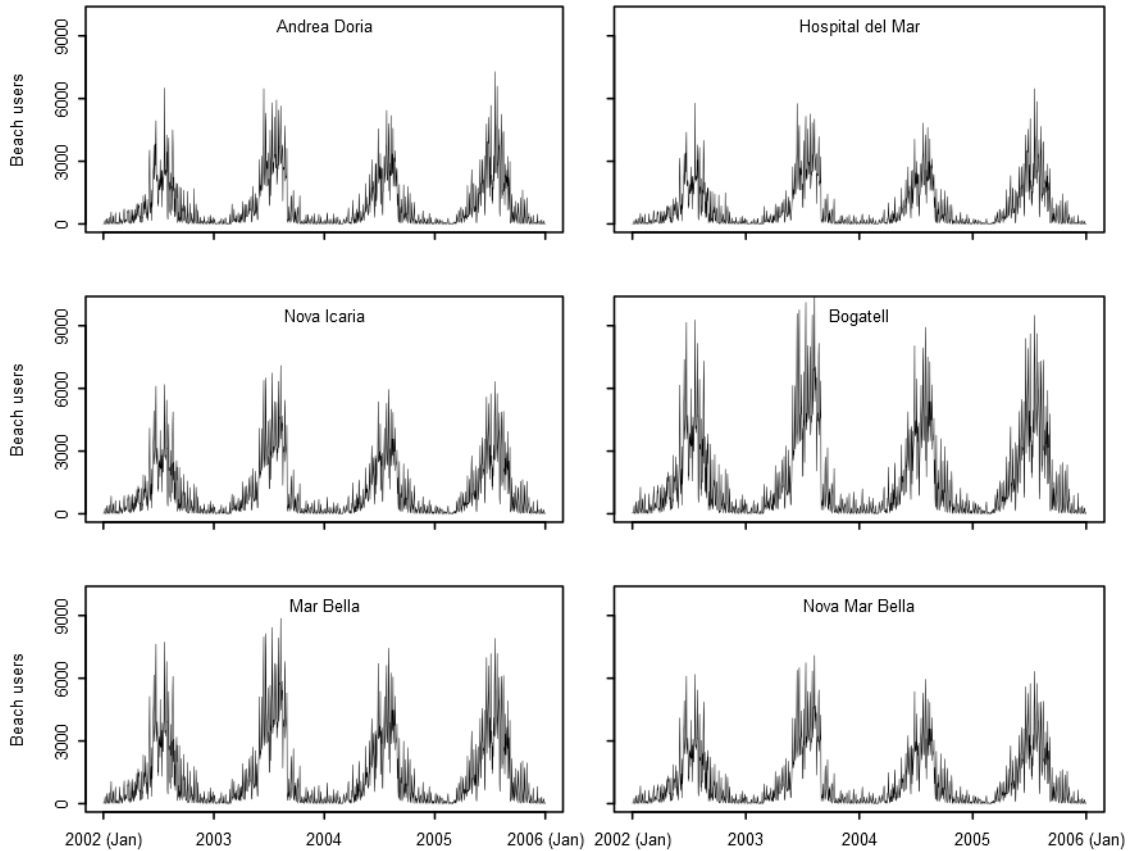
The Guillén et al. (2008) model for predicting beach users has a fit accuracy (percentage of variation explained by model) of  $R^2 = 61.0\%$  for Nova Icaria and  $R^2 = 40.4\%$  for Andrea Doria. Fig. 16 shows the observed values versus model prediction.

Fig. 16: Guillén et al. model for daily beach users at Nova Icaria and Hospital del Mar.



The model output for each beach is shown in Fig. 17 when there is no impact on recreational appeal. (The sewer network parameters used are those that represent the current situation: 50% direct runoff; stormwater collector capacity is  $5.2 \times 10^5 \text{ m}^3$ ; and no outflow from the WWTP). There is no data to corroborate the results for beaches not analysed in Guillén et al. (2008).

Fig. 17: Number of beach users when effect on recreational appeal is zero

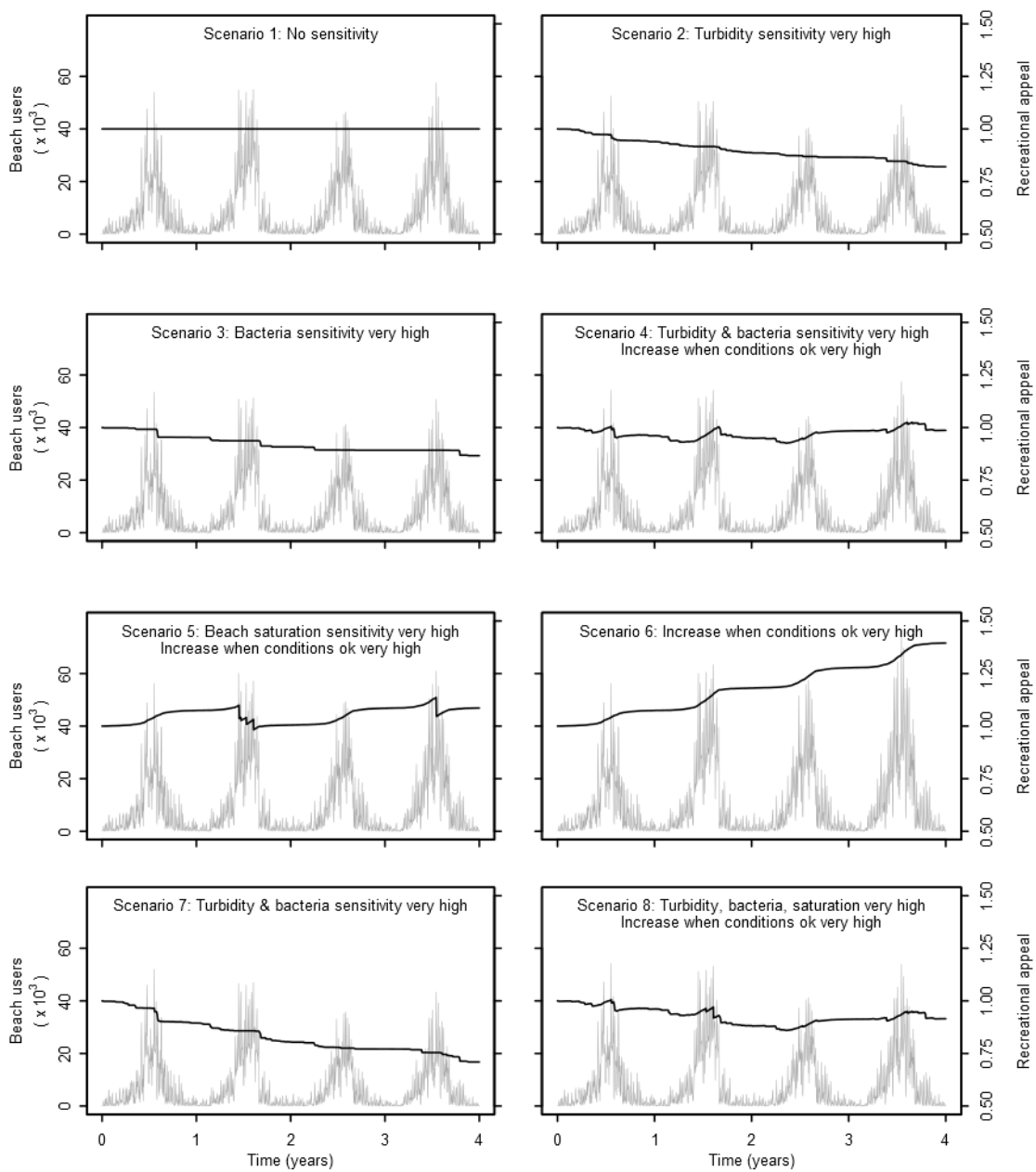


As described in Chapter 2.4.4, the recreational appeal model cannot be verified until a survey has been undertaken. Until then, the impact of: turbidity (suspended solids); beach closure caused by excessive faecal coliforms; beach saturation; and “ok conditions” on recreational appeal can be user defined in the model parameters and the effects measured during scenario analysis. “ok conditions” refers to an increase in recreational appeal when none of the other three events which decrease recreational appeal occurs.

The value of the impact on recreational appeal for each of these four scenario options can take one of five values from “zero” to “very high”. These values within the model were determined in the following way (Fig. 18). The value was calculated for “very high” sensitivity to turbidity (suspended solids) which would reduce recreational appeal over 4 years by 20% (for an average reduction of 5% a year) (Fig. 18 – Scenario 2). Similarly, the value was calculated for “very high” sensitivity to beach closure (faecal coliform limit exceeded) which would reduce recreational appeal by an average of 5% a year (Fig. 18 – Scenario 3). Next a value was sought for the value which would increase recreational appeal when neither turbid nor beach closure occurred (referred to as “conditions ok” in the figure). The “very high” value of this would counteract the “very high” values of turbidity sensitivity and bacteria sensitivity over four years, with the recreational appeal returning to 1 (Fig. 18 – Scenario 4). Note that the recreational appeal still increases and decreases during this time but the overall effect is neutral. Finally a “very high” value was sought for beach saturation when the increase in recreational appeal (“conditions ok”) was “very high”. The “very high” value of beach saturation would counteract the “very high” value of ok conditions. Finally the values for “low”, “medium” and “high” for each of these four parameters were interpolated between the “very high” value and the “none” value (which is “0”). The final calculated values for the effect on recreational appeal by turbidity, beach closure (bacteria), beach saturation are listed in Appendix IV with other scenario options.

Clearly, these values are estimates and ideally should be replaced by data corroborated by objective evidence in the future. It is also probable that the sensitivity to turbidity is dependent on the concentration of suspended solids (rather than a fixed value like the model uses).

Fig. 18: Effect of beach closure (bacteria) and turbidity on recreational appeal

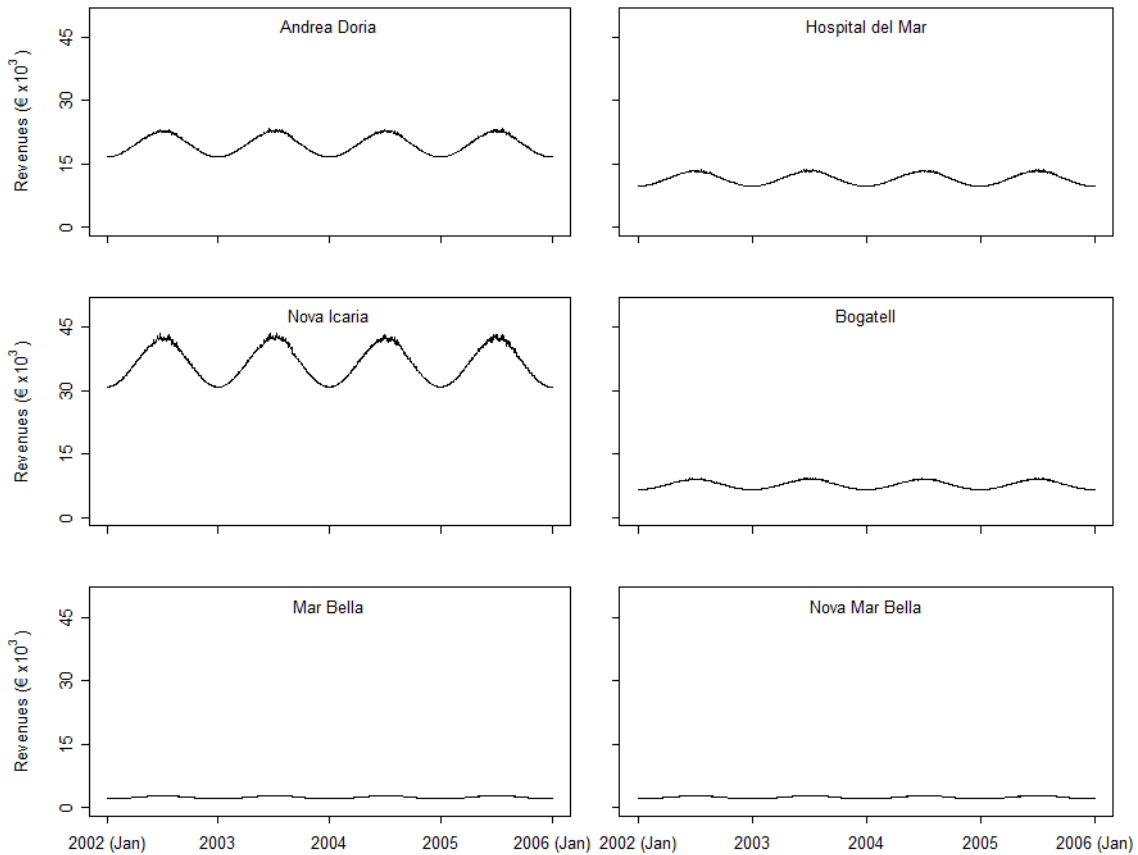


### 2.5.5 Economic evaluation sub-model

The revenues from the bars and restaurants at each beach are shown in Fig. 19. However, as explained in Chapter 2.4.5, most of the revenues do not necessarily come from beach users but from customers who do not visit the beach. The revenues per year for all beaches combined in the current situation (50% direct runoff; stormwater collector capacity of  $5.2 \times 10^5 \text{ m}^3$ ) and with no sensitivity to suspended solids or beach closure (bacteria) are €29.36 million. Even in the (unlikely) scenario where both sensitivity to suspended solids and bacteria are very high, and the value for increase in “ok

conditions” is zero, then revenues only fall to €29.33 million year<sup>-1</sup> (0.13% decline). Clearly, the effect of water quality has a low impact on market value (revenues). However, the value on non-market value as calculated using the travel cost method is considerable.

Fig. 19: Daily revenues of restaurants, restaurant-bars and bars



The travel cost sub-model calculates the consumer surplus every day. However the aggregated value over the year (for 2.97 million visits to the beach) calculates the visit rate curve to be:

$$y = 156.63 e^{-0.0280x} \quad (R^2 = 0.91)$$

And the demand curve to be:

$$y = -35.755 \log_e(x) + 464.74 \quad (R^2 = 1.0)$$

The total consumer surplus (per year) would therefore be €18.79 million, and the individual consumer surplus is €6.33 (when sensitivity to turbidity and bacteria are zero). This result is similar

to other research regarding calculation of consumer surplus using the travel cost method. The beach at Doñana Natural Park (Spain) was calculated as having total social welfare value of €12.9 million, and an individual consumer surplus of €16.61 for a zonal TCM (Martín-López et al. 2009).

In the scenario where sensitivity to suspended solids and bacteria is very high and the value for increase in “ok conditions” is zero, the non-market value of the beaches falls to €13.25 million (decrease by 17.5%).

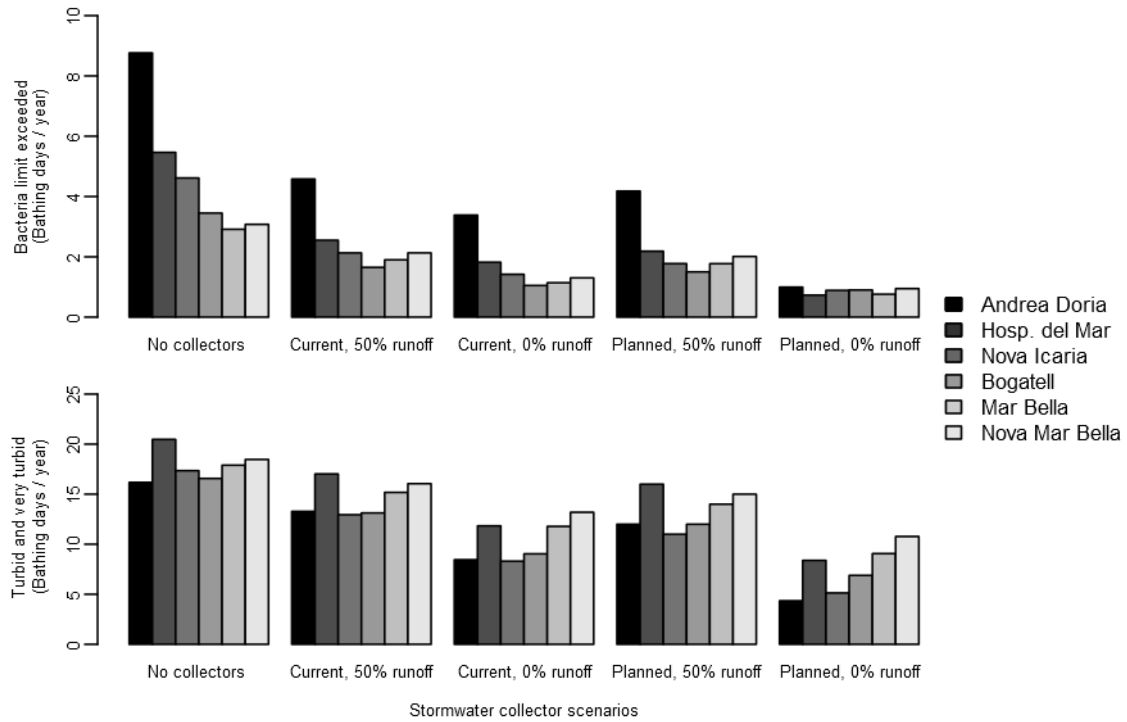
## 2.6 System Output

The System Output has two components – the calculation of the model output for all the connected sub-models for each scenario, and the presentation to the stakeholders. The model was run for a four-year forecast period. Following these calculations, the results were summarised and presented in two meetings with stakeholders.

### 2.6.1 Scenario analysis

The scenario options (Appendix IV) can be split into two components – ecological and social. The principal ecological component is the analysis of increasing the capacity of the stormwater collectors as well as the direct runoff to the beach waters (As previously explained - this is determined by the geographical position of the collectors and the management operational decisions). The effect of these scenario options effects the number of bathing days (per year) in which the faecal coliform limit is exceeded (beach closure) and in which the water is turbid (Fig. 20). The current situation ( $5.2 \times 10^5 \text{ m}^3$ ; 50% runoff) is compared against improving the direct runoff percentage and increasing the total stormwater collector capacity to those planned for construction ( $14.9 \times 10^5 \text{ m}^3$ ). There is not much decrease in “bacteria limit exceeded” and “turbid” bathing days by only increasing the collector capacity. There would also need to be a decrease in the direct runoff percentage. As previously discussed, it would be almost impossible to decrease to 0% so this is shown as a theoretical limit of the system. This doesn’t imply that the stormwater collectors are not effective because comparing the “current” situation to the scenario with “No collectors” – there has been a considerable improvement in the reducing the number of “bacteria limit exceeded” and “turbid” bathing days.

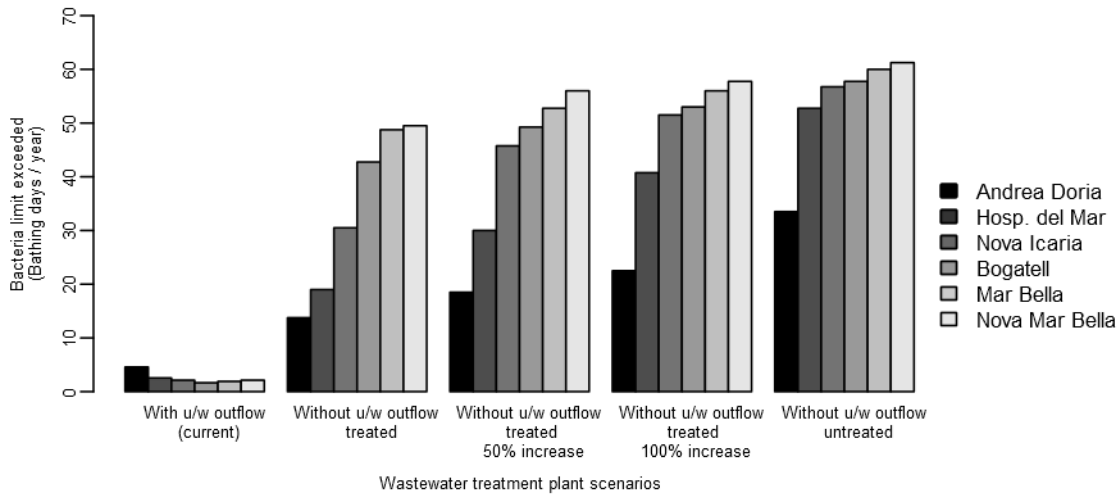
Fig. 20: Impact on “bacteria limit exceeded” and “turbid” bathing days for various stormwater collector scenarios



A secondary ecological scenario option regarding the output of the wastewater treatment plant was not included as a management option, but rather to test a “disaster scenario” - the impact of a temporary failure of the underwater outflow of the WWTP. However, given that the “disaster scenario” would likely only last a few days at most, the overall impact this has on beach water quality and recreational appeal is close to zero. Although a purely hypothetical situation, the model can predict the impact on “bacteria limit exceeded” bathing days if the underwater outflow did not exist and if the effluent increased and was treated (Fig. 21). As expected, the beaches nearest to the WWTP (Nova Mar Bella) would receive the greatest impact. Clearly the underwater outflow has been very beneficial in maintaining the beach water free of bacteria.



Fig. 21: Wastewater treatment plant scenarios



The social component of the scenarios is the impact that these ecological changes have on the number of beach users, and the economic effect this has on market goods and services (revenues from bars and restaurants) and on the non-market value of the beach (travel cost method). Table 6 summarises these results. Note that the values for individual beach have been averaged for bacteria and turbidity, and aggregated for the number of beach users.

The beach user sensitivity (to bacteria and turbidity) is currently unknown, so only the two extremes available in the scenario options are shown in the table: “none” and “very high”. The real sensitivity and thus the number of beach users, revenues and non-market value of the beach will likely be within this range. There is negligible difference in revenues between the various scenarios. Given a “very high” sensitivity, The “Planned with improved runoff” scenario would increase the non-market value of the beach by €1.27 million (8% increase) compared to the current situation.

Also included in the table is the estimated cost of constructing the stormwater collectors, although the yearly operational costs are not included as there was no available data.

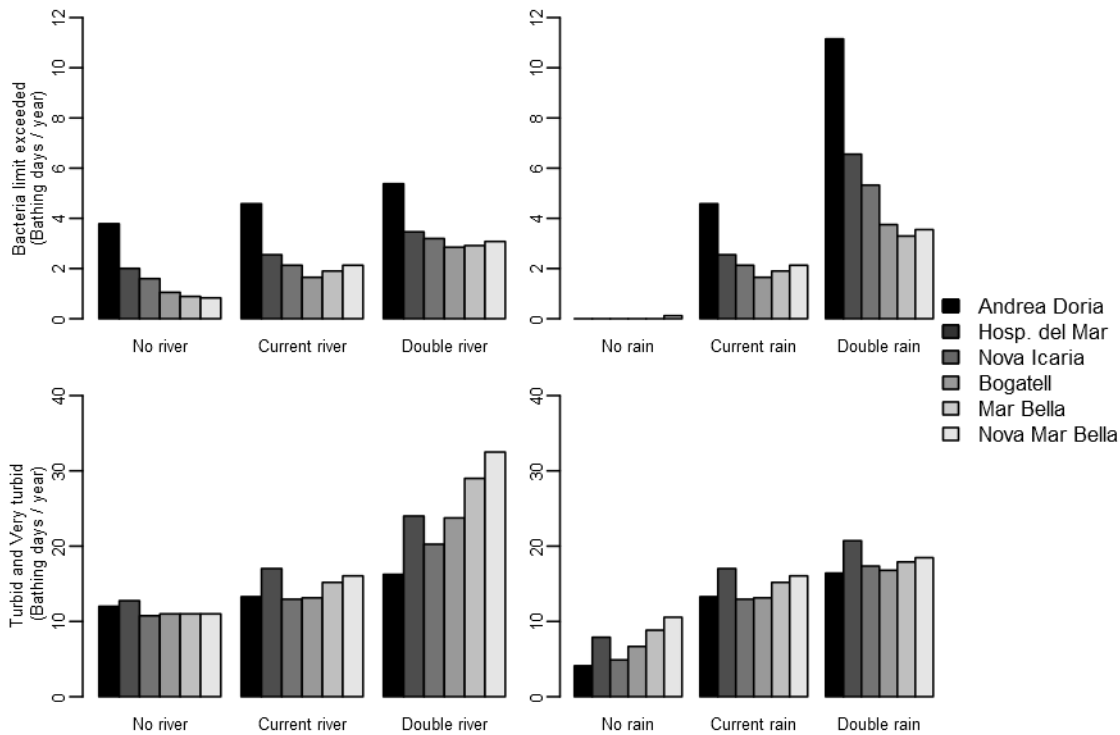
Table 6: Stormwater collector scenarios

Variables / Indicators	Units and details	Stormwater collector scenarios					
		No collectors (simulated)	Current	Current with improved runoff (simulated)	Planned (simulated)	Planned with improved runoff (simulated)	
Sewerage system	Stormwater collector capacity ( $10^5 \text{ m}^3$ )	—	5.2	5.2	14.9	14.9	
	Runoff direct to beach water (%)	100	50	—	50	—	
Bacteria	Bacteria limit exceeded (bathing days / year)	4.71	2.49	1.69	2.23	0.87	
Turbidity	"Turbid" and "Very turbid" (bathing days / year)	17.82	14.6	10.44	13.33	7.41	
Beach user sensitivity	Beach user sensitivity to beach closure (bacteria) and turbidity	none	very high	none	very high	very high	
Beach users	Visitors per year (millions)	2.97	2.97	2.97	2.97	2.66	
Non-market value	Travel cost evaluation per year (€ M)	18.79	18.79	18.79	18.79	16.80	
Market value	Revenues from restaurants, restaurant-bars and bars (€ M)	29.36	29.36	29.36	29.36	29.34	
Cost stormwater collectors	Construction cost per scenario (€ M)	—	150	150	450	450	

### 2.6.2 Sensitivity of output to changes in river flow and rain

The two primary inputs that affect the bacteria and turbidity in the beach water are precipitation (CSO) and the nearby river. A sensitivity analysis on these inputs was analysed where the daily values of rain and river flow were both doubled and set to zero (Fig. 22). These scenarios are not user options within the model presented to the stakeholders, but are useful in analysing the individual impact of rain and the river. Rain has a greater impact than the river, on the number of bathing days where the bacteria limit is exceeded. Doubling rainfall increases the number of “bacteria limit exceeded” bathing days by 125%, in comparison to doubling the river flow which increases it by 40%. However rainfall has a lesser impact on turbidity compared to the river. Doubling rainfall increases the number of “turbid” and “very turbid” bathing days by 22%, in comparison to doubling the river flow which increases it by 66%.

Fig. 22: Sensitivity analysis of the river and rain on bacteria and water clarity



### 2.6.3 Presentation to stakeholders

The scientific team could not perform the output step as outlined by the SAF manual. Our stakeholder group had become reduced due to time and resource constraints as well as the previous decision by the scientific team of working with a small and operative group of stakeholders mainly linked to the administrative domain. For the output step we only had the continuing support of the Catalan Water Agency (ACA) - the principal stakeholder regarding water and coastal affairs at the regional scale. We performed two presentations at events hosted by ACA. The first was an in-depth meeting on 10<sup>th</sup> March 2010 in which only representatives and technicians for coastal affairs from ACA attended. The second presentation on 23<sup>rd</sup> March 2010 was at a meeting of *The Commission for Coastal Affairs* – a regularly organized forum between coastal stakeholders from all Catalonia (not just the local scale of Barcelona), including representatives from local administrations of coastal municipalities and agencies related to management and decision making in several issues concerning coastal zone management. At both meetings the scientific team consisted of three participants: The team leader (Dolors Blasco) who presented the SAF methodology, the model (presented here), results and conclusions; myself (Ben Tomlinson) and Sergio Sastre were also present in case there were technical questions regarding the ecological and socio-economic components of the model.

Due to time constraints of the stakeholders, we were not able to prepare the scenarios together with them as outlined in the SAF manual. However during the first meeting, we consulted the ACA representatives on the relevancy and interest of the scenarios selected by the scientific team and they agreed they should be presented at the second meeting: The baseline scenario which represents the current situation; a scenario based on the current planned infrastructures (stormwater collectors); and a scenario in which the pumping station for the emissary of the wastewater treatment plant fails, releasing the sewage (either treated or untreated) into the coastal water.

The presentation format for both meetings was limited to a power point presentation. The audience was not very diverse. Among the attendants there were policymakers, managers and technicians in the field of coastal affairs, and they were all used to receiving information presented in this format. The audience should not necessarily be considered as experts on the issue we presented but they all shared both sufficient knowledge and the technical skills to understand the concepts of the model and its implications. However certain technical terms were not well known, so the scientific team translated or clarified some of the concepts alien to the audience such as “stakeholder” as well as some technical details regarding the results.

### 2.6.3.1 Presentation to Catalan Water Agency

The first presentation was prepared for four technical and managerial employees of ACA as well as the director for coastal affairs so that they could more fully understand the subject matter and determine whether it was suitable for the second meeting - *The Commission for Coastal Affairs*. Our institution and this peer group have worked together in several other projects so it was relatively easy to arrange. The meeting lasted around three hours in which the prime objective was to present both the SAF methodology and the application to the case study. One of the attendees had already participated in the SAF whereas the others had not.

The results were presented in PowerPoint because it was an easy and familiar way of showing information for the audience. We were especially careful in choosing the indicators and the comparative scenario. The economic dimension was expected to be more difficult to understand so we tried to support results with newspaper pictures and news related to the issue in order to put it in context. Uncertainties, assumptions and data gaps were presented openly and transparently, during the presentation, explaining how calculations had been done, as well as the main weaknesses in the model. Explaining results in terms of order of magnitude instead of absolute numbers helped to express an approach not based in accuracy but in knowledge and understanding of a system and its performance. Due to the lack of data to verify the model, the results were described as a theoretical possibility rather than a high probability. Interestingly though, the model produced results which ACA had already suspected – that the efficacy of constructing further stormwater collectors to reduce water quality was debatable. Compared to the second presentation, the technical aspects were more fully developed and there was considerable time for discussion. At the end of the first meeting there was time to show the model running various scenarios, but the attendees chose not to run the model themselves. Screenshots of the model are shown in Appendix IX.

We made copies of the presentation available to the attendees as well as a report (with model details, results and conclusions) completed as part of the SPICOSA project. They were able to comprehend the scientific information so no additional narrative information was needed.

One of the objectives of the SAF and our model was to demonstrate to the stakeholders a broad overview of how the social-ecosystem works. The attendees understood this from our presentation

and expressed an interest in this approach. Although ecosystems as crucial assets for human well-being is not an obvious link, the SAF has the ability of making this link clearer, portraying it in the same context as ecosystem variables (model) working dynamically, or at least showing a certain degree of change over time. The attendees regarded the SAF as innovative and interesting and thought it could aid in creating new knowledge on issues directly related to coastal management. They said that our work has contributed to a question they were interested in and felt they could understand the model and results. They were often presented with more complex models which were difficult to understand, and impossible to verify. Therefore it seems that this case study found a balance between complexity and usefulness for the end users.

The attendees did not fully understand how a stakeholder (manager, technician or otherwise) can use the SAF. They asked about availability of material such as manuals (which was not publicly available at the time) as well as if our research institute would be involved in consultancy work for SAF applications. They expected us to be able to “sell” SAF as a methodological package to managers. They also suggested to us that for the second presentation we should include other issues which have been undertaken using the SAF methodology.

#### 2.6.3.2 Presentation to Commission of Coastal Affairs

The second presentation was within the forum of *The Commission for Coastal Affairs*, in which around 50 participants attended and presented various issues regarding coastal management at the regional scale for Catalonia. Our presentation lasted 35 minutes, and the main objective was to briefly present the methodology of the SAF, followed by the case study described here. We knew from the beginning that time constraints would not allow for a deliberation session, so we focused on presenting the SAF and the results and possible application to the regional scale giving the example of the Barcelona pilot site, by including newspaper articles about possible future issues (sediment transport, infrastructures). We chose an average level of technical understanding in which the main concepts of the SAF were explained (such as stakeholder and social-ecological systems) but took into account that most of the audience work every day with coastal affairs so would be familiar with much of the terminology. The Economic dimension was explained more in depth since non-market valuation is not a commonly used technique for this audience and many were familiar neither with these concepts, nor with the correct interpretation of the results.

The presentation had to be shorter than the first presentation, although the main points were presented. There was less technical details on the project itself and was very much focused on clarifying how the SAF methodology works, and how it could be useful for the attendees as well as the results from this case study. We demonstrated the model as screenshots during the presentation although not in too much detail, by displaying the hierarchical levels, and the different components (Appendix IX). We did not run the modelling software due to time considerations, and the results were more easily understood once shown aggregated as tables and figures. Before the second meeting we were recommended not to deliver any documents since it was a forum in which there were multiple objectives.

There was no time for deliberation, but a few stakeholders approached us afterwards regarding the conclusion of the model. For example a manager of a coastal town further north of Barcelona was considering constructing stormwater collectors in the town but was unsure whether it would be beneficial. He asked if our model could be directly applied in the town. We responded it would only be useful depending on the amount of data (bacteria and turbidity) they had available.

Additionally, the stakeholder that managed the sewerage network and stormwater collectors (CLABSA) who had declined to attend our previous meetings (but was present here) was now keen to share their time, data, and expertise with us, given that the model produced results that were contrary to their economics interests. They realized it would be prudent for them to participate in future iterations of the SAF regarding this issue. Unfortunately, given that the SPICOSA project was finishing, there was no time or resources to continue with this SAF application.

Another participant commented on the reliability of data regarding bacteria. The person who raised this question was a professor of medicine who did not trust our results as she was generally sceptical of models. We offered to show her the model so she could understand our calculations. One of the objectives of the SAF is to simplify over-complex models and capture just the most important functioning components of the system. Perhaps if we would have had more time with this stakeholder, then we could have convinced her that our model was not too complex to understand.

Other attendees asked us regarding the possibility of applying SAF in other places and issues, as well as the necessary time and resources.

## 2.7 Discussion

There are two sets of conclusions that can be made from this application of the Systems Approach Framework. Firstly, there are conclusions that can be made from the modelling component of the application, and secondly there are conclusions related to the application as a whole – whether it met the objectives of the SAF, and what was learned during the process.

### 2.7.1 Discussion of the model

As previously discussed in System Output (Chapter 2.6) and openly declared during the stakeholder meetings, the model results should be considered as more of a theoretical possibility rather than an accurate prediction for a number of reasons. There are many unknown parameters which are either user definable in the scenario options (sensitivity of the beach users to turbidity, beach closure caused by bacteria, and over-crowding); have been calculated using the optimizer (dispersion of suspended solids and bacteria from the beach water); or simplifications of the real system due to lack of data (quantities of bacteria and suspended solids in CSO outflow, and the river). However, probably the most crucial lack in knowledge is the current functioning of the sewerage network, due to the fact that the stakeholder that had this knowledge initially chose not to participate in the SAF application. This problem might have been resolved had the SPICOSA project been able to continue for further iterations, which is a general problem of applied scientific research based on 3-4 year projects. There was a brief meeting with CLABSA following the end of the SPICOSA project where CLABSA offered to share their data and information, but there were not sufficient resources available to the scientific team to do so. Aside from this lack of data and knowledge, the observed data that was available was of a limited resolution (both spatially and temporally), and in the case of turbidity the data was subjective. This had the effect that the model became over reliant on parameters which have been calculated using the optimizer. It would be recommendable to verify these parameters by collecting high resolution data and comparing it to the model output. Obviously, this would be expensive in terms of time and resources.

There were limitations found in using the modelling software (ExtendSim) as required by the SPICOSA project. ExtendSim is useful for modelling continuous systems in which delays and feedbacks are commonplace and critical to understanding the correct functioning of a system. However, there are difficulties in constructing models with a high spatial resolution in ExtendSim. A high spatial resolution would be necessary to improve the beach water quality model, for example



by using a geophysical hydrodynamic model. Another problem with ExtendSim is that the time-step and time-per-step have to be set for the entire model (rather than being definable for each sub-model or component of a sub-model). This can slow the model considerably as many unnecessary calculations are performed per time-step. It should be noted that this problem can be alleviated to some extent by using the user programmable blocks instead of the predefined blocks in the software. However, using user-programmable blocks could create “black box” syndrome for the stakeholders which the SAF tries to avoid (as discussed in Chapter 1.4).

Despite these limitations the model performs adequately when comparing the model results to the available observed data (System Appraisal – Chapter 2.5). The model output implies that the stormwater collectors have been useful in improving beach water quality in Barcelona, but there will be diminished returns in constructing more. The value of the beach is clearly large in terms of both non-market value and revenues generated in the nearby bars and restaurants. However, the impact changes in water quality would have on the recreational appeal of the beach is estimated to be low but further research is recommended to determine beach users’ sensitivity to beach closures (bacteria limit exceeded) and turbidity.

Although there are many studies regarding the impact of CSO events in many cities around the world (Zoppou 2001, Cembrano et al. 2004, Rossi et al. 2005, Soonthornnonda and Christensen 2008), there are few studies specific to Barcelona. Suárez and Puertas (2005) found higher than previously reported pollutant loads in CSO events in Barcelona, but no first-flush effect. They recommend a more effective cleaning policy or the construction of separate sewerage systems to mitigate CSO events. However the impact this has on the beach water or its users was not investigated. This study is the first known to the authors which demonstrates the link of CSO events to beach water quality and subsequently to the beach users.

Four other study sites within the SPICOSA project also analysed the impact of changes in water quality on tourism or beach users. Guimarães et al. (2012) used a contingent valuation method to analyse the impact of faecal coliforms in the Guadiana estuarine system. The average willingness-to-pay was €47.14 (one-time payment) in order to achieve Blue Flag Award (BFA) status (good environmental quality) for all beaches within the estuary, by improving the wastewater treatment efficiency so 99% of faecal coliforms are removed. They also showed a strong correlation between the number of beach users and those beaches with BFA status.

Moncheva et al. (2012) applied the SAF in the coastal resort of Varna Bay, Bulgaria in order to model the impact of improvements in sewer systems and wastewater treatment plants on the beach water. The primary indicator was Secchi depth calculated as a function of nitrogen loading and total suspended solids. The desired level of water clarity could be achieved if 80% of the rainwater was collected and treated before being released and WWTPs upgraded to remove 75% of nitrogen. Questionnaires were completed by a thousand randomly selected people to calculate the influence this impact could have on the attractiveness of the resort. Projected losses on the local tourism could be as high as €1230 million over 10 years if the €200 million investment in an improved wastewater treatment system was not undertaken.

Franzen et al. (2011) analysed the impact of sewage from households and agriculture on the recreational appeal of the Himmerfjarden region in Sweden. The primary indicator was Secchi depth which depends primarily on nitrogen from wastewater treatment plant and nearby agriculture. Various scenarios were presented to stakeholders and a choice experiment elicited the willingness-to-pay for each option. In the “most likely” scenario in which the WWTP reduced nitrogen concentration to 4 mg / L and a wetland was created to mitigate runoff from agriculture, improvements to the water clarity would have a net benefit of €19 million.

Tolun et al. (2012) investigated changes in water transparency caused by wastewater and river runoff in Izmit Bay, Turkey. Using a contingent valuation survey, respondents are willing to pay on average €18.70 per year for better water quality, which is greater than the expected costs of constructing wastewater treatment plants to achieve this.

In all four case studies, the researchers undertook some form of survey or questionnaire to elicit a value of the environmental good, or a price that the local population was willing-to-pay to improve the environmental conditions. It is not clear that their analysis actually influenced in the final decision making process although they all state that the stakeholder participation had been positive and helped to create social capital which would be beneficial in future deliberations.

As previously explained the scientific team applied the modelling methodology as recommended by the SPICOSA project, which does not necessarily produce the most accurate model for any one component but tries to recreate the fundamental links between them, capturing the general functioning of the social-ecosystem. This leaves each component (or sub-model) susceptible to

criticism by specialists in that field of expertise. However, the results of the model are still useful and should be seen in the context of the SAF application as a whole.

### 2.7.2 Discussion of the SAF application

The SAF methodology does not intend to supply the “correct” answer to an issue or problem - it merely provides the stakeholders with a base from which to structure the debate. The model is just a tool that can provide further information, highlight complex processes, and clarify doubts. The scientists should not decide policy or make managerial decisions because this is the role of the stakeholders and policy makers, but they should be available to explain the implication of the model as well as its veracity and validity. It also allows stakeholders with no modelling background to be exposed to models and output results from various scenario and management options, as well as have direct contact with scientists. Sometimes scientists are seen as being aloof and difficult or intimidating to approach. The SAF can help to break these barriers.

At the beginning of implementation of the SAF, an ad hoc forum was created for the relevant stakeholders to debate issues regarding the littoral areas of Barcelona. But due to time, resource, and personnel constraints, participation was less than exemplary. Towards the end of the SAF implementation, the scientific team discovered the existence of a regular organized forum between coastal stakeholders from all Catalonia (not just the local scale of Barcelona), the Commission of Coastal Affairs. The scientific team presented both the SAF methodology and the initial results of the model and their implication, as previously discussed in System Formulation and System Appraisal. A stakeholder who had previously declined the initial ad hoc forum attended this forum, and following the presentation, expressed interest in participating further in the process to help improve the model, possibly by supplying data and information. The forum of the Commission of Coastal Affairs was discovered late in the application of the SAF, and the fact that it was not identified earlier should be considered an oversight by the scientific team. Given the social capital already invested in this commission, it would have been preferable to apply the SAF here rather than creating ad hoc meetings as we did.

This SAF application highlights an important aspect of participatory management. It demonstrates that a deficit in social capital (OECD 2001, Ostrom and Ahn 2010) can seriously deter any participatory management process. Even with pre-existing forums, they need to be at the correct scale for the chosen issue for the process to function adequately. However, for social capital to be

built, confidence between the stakeholders needs to increase. The SAF methodology offers an opportunity for this to occur. Through continuous iterations of the SAF, the stakeholders are likely to grow more confident with each other and observe the benefits in participation in the process. Increasing social capital is a lengthy process and cannot be achieved immediately, so it is not surprising that in our case study, the benefits started to appear only towards the end of the project, about three years after its initiation. The necessity of having a critical mass of scientists and stakeholders willing and interested in the SAF process is crucial to its success. Further iterations of the SAF could increase this social capital, improving participation and the decision making process. There needs to be real engagement between the stakeholders and not treat it just as a “game” or hypothetical situation for the interest only of the scientists. No management decisions regarding the stormwater collectors or other scenarios presented were made following the final stakeholder meeting. However, the application of the SAF demonstrated its ability to create and maintain social capital, which could be beneficial for future collaboration.

A significant problem encountered whilst constructing the model was the lack of information (regarding the correct functioning of the sewerage and stormwater collectors) and a lack of data for calibration and verification. Similarly, the lack of social data on user perception of water quality weakened the implications of the model given that we could only present the results as a hypothetical possibility. These limitations made our presentation not very useful in the context of presenting strong quantitative results. However a quantitative result was not the main objective of our model, but improved data would have allowed a stronger numerical approximation and relevance. We emphasized the uncertainty in the model output but were confident that the orders of magnitude were correct. The software used was beneficial in constructing a model that the stakeholders could both easily understand (due to its hierarchical structure) and manipulate (drop-down menus for running various scenarios). To some extent, this diminished the “black box syndrome” that many models suffer, and encouraged the stakeholders to further engage with both the model output and the deliberation process. A mathematical model would not always be necessary. Sometimes it would be sufficient to just have a conceptual model depending on the complexity of the issue.

This application of the SAF was both experimental within the SPICOSA project and to the scientific team undertaking the study. There was probably not enough consideration when choosing which issue to study or which scenarios were the most relevant to the stakeholders involved in the meetings. This might have been caused by the lack of a social-scientist within the scientific team who

could have highlighted these problems earlier and steered the investigation towards a more relevant or feasible issue. The importance of a true multidisciplinary approach, rather than one discipline attempting to apply its methodologies to other disciplines, is both challenging and relatively rare. The interaction of scientists with different scientific backgrounds, expertise and opinions creates a dialogue such that fresh approaches can be applied.

The current phase regime in Barcelona is one where typical coastline ecosystem services such as food production and fish nurseries have decreased, and in their place information services such as recreation and aesthetic appeal are favoured. This can be seen as either an implicit decision by the city's residents or an unconscious adaptation to modern times. Either way, the residents may be unaware of the large costs (in energy, resources, money, and personnel) involved in maintaining the beaches in their current state. During shocks to the social-ecological system (e.g., general economic crisis, increase in price of energy, increased storm activity and erosion caused by climate change, sea-level rise), there might be less impetus by the public to continue with this sort of investment, and the beaches would slowly transform to a regime that does not require a constant input of exosomatic energy and resources in order to be perpetuated. Any type of resilience management has to examine this issue through the lens of this implication. Resilience Adaptive Management explores these issues and is further explored in the discussion (Chapter 4.3). The application of this first iteration of the SAF to the case study of Barcelona sufficiently explores various scenarios as requested by the stakeholders but from the perspective of a reduced temporal scale. Through further iterations, it would be possible to include shocks to examine the resilience of the social-ecological system over a larger temporal scale.

### 3 Application 2 (VECTORS project) – Jellyfish, fisheries and beach users

#### 3.1 Background and context of the VECTORS project

Before describing the details of this second SAF application, it is important to describe the context in which it was undertaken. Only then can we understand why certain decisions were taken, whether they were beneficial or detrimental to the process and what we can learn from the application as a whole.

As we have previously noted, the SAF application is resource dependent in terms of time, money, knowledge, data, scientific personnel and other relevant stakeholders. A continual source of funding for a sustained period is therefore necessary to successfully apply a SAF methodology. Funding was applied for and granted within a *Work Task* of the four-year project “Vectors of Change in Oceans and Seas Marine Life, Impact on Economic Sectors” (VECTORS) - project reference 266445, as part of the European Commission’s Seventh Framework Programme (FP7-KBBE, 2007–2013, [www.marine-vectors.eu](http://www.marine-vectors.eu)). The VECTORS project was a multidisciplinary project with more than 200 expert researchers from 16 different countries from 2011 until 2014, costing around €12 million. The work task relevant to this thesis is described as:

*“The modelling approach (System approach methodology and ExtendSim simulation models) that the Institut Ciències del Mar (partner CSIC ICM) has carried out for the project SPICOSA, will be used and refined, to combine existing knowledge and results acquired in the previous Tasks, and considering all the topics analyzed in detail, to evaluate economic, social and ecological futures in the Western Mediterranean Regional Sea. It will also provide a starting point for the dialogue with stakeholders and administrators in the Western Mediterranean Region.”*

(VECTORS Description of Work, page 48)

The “previous Tasks” on which this *Work Task* was to be based are described below. These work tasks were grouped together in a “Western Mediterranean” section but each *Task* was to be carried out for a specific zone only (e.g. Catalan Coast, Oristano Gulf, Tuscano Archipelago), and not for the entire Western Mediterranean:

- Quantify the temporal and spatial effects of fisheries on demersal communities. Current and future trends
- Quantify temporal and spatial effects of climate change on pelagic species distribution
- Jellyfish (indigenous and non-indigenous) outbreaks
- Quantify the likelihood of extreme climate conditions leading to loss of coastal biodiversity through the environmental bootstrap method
- Impacts on ecosystem and functioning
- The impact of environmental changes on the ecosystem structures and function in near shore habitats
- A dynamic bio-economic simulation model
- A contingent valuation study

(VECTORS Description of Work, page 46-48)

The following step in a SAF application would then normally involve the convocation of the relevant stakeholders to begin a dialogue, in which an *Issue* is chosen, and the believed causes and effects, and possible “solutions” (prevention, mitigation or adaptation) of the problem are expressed. Contact was made with the stakeholders in who participated during the previous SAF application (SPICOSA) in March 2011: The Catalan Water Agency (ACA); The Fisheries Department of Catalonia; Barcelona City Council; Barcelona Port Authority. However they expressed a lack of willingness to engage due to a lack of human resources. There had recently been an economic downturn in the national economy with many cuts to local public services. This reduced their time to participate in experimental projects such as the SAF. Other stakeholders such as the port authorities and fishing organisations expressed an interest in receiving the results but did not have time to participate in the whole SAF process.

The scientific team therefore chose to continue the application with the aspiration of demonstrating the SAF model and results at a later date if the stakeholders found the required resources to engage with the process. A SAF application would ideally not have such restrictions imposed on it, but given the constraints on external stakeholders, we decided that the best course of action would be to continue with the resources we had available.

A meeting was held by the multidisciplinary scientific team of the SAF application, and the scientists involved in the other VECTORS project work tasks as described above, to agree upon a possible SAF model. It was obvious that not all work tasks could be included in a single social-ecological model,

given the weak interactions between such issues, often due to the geographical distance between where the issues occur. The issue as described below was decided upon because it was relevant to multiple work tasks within the VECTORS project, and was feasible given the knowledge and data available. Therefore this SAF application can be seen more as a traditional theoretical scientific study than the SPICOSA application in the previous chapter. However, due to the complementary nature (different scientific domains) and the long experience of the scientists, this application can be seen as a partial SAF that will produce a portfolio of results than can be discussed with external stakeholders when the opportunity arises.

### 3.2 Issue Identification

It has long been suspected that the frequency and duration of jellyfish blooms are increasing within the Catalan Sea, although there is a lack of long term observations to confirm this (Purcell et al. 2007, Pauly et al. 2009). The presence of jellyfish is a naturally occurring phenomenon (Gili et al. 1988, Goy et al. 1989, Calvo et al. 2011, Condon et al. 2012), but in recent years various factors are thought to have increased the probability of large aggregated blooms forming including but not limited to: increased water temperature; over-fishing of predators and competitors; eutrophication; habitat modification (creating more surfaces for polyps<sup>3</sup> to attach to) and translocation of non-native species of jellyfish via ballast water or ship hulls (Purcell et al. 2007, Richardson et al. 2009, Duarte et al. 2013).

This increase in numbers can have a detrimental effect on a number of human systems including, but not limited to, stinging bathers (and beach users), clogging fishing gears, altering food-webs, and damaging aquaculture and coastal power plant operations (Purcell et al. 2007). In Catalonia, tourism is largely based on the “sun and beach” model (Ariza et al. 2008), with around 16 million visitors per year generating revenues of €14 billion per year (IDESCAT 2010) (Fig. 23). The arrival of jellyfish to coastal waters can have a negative impact on beach users and bathers, either by stinging the bathers or by reducing the recreational appeal of the beach. There are numerous cases where this impact has been significant and damaged the local tourist industry (Purcell et al. 2007, Richardson et al. 2009).

---

<sup>3</sup> The polyp stage of jellyfish occurs once the fertilised eggs have hatched and formed free-swimming planula larvae. The planula larva attaches itself to a hard surface and transforms into a polyp. Once mature, part of the polyp buds off as a tiny jellyfish called ephyra. Not all jellyfish have a polyp stage.



Jellyfish are also known to interact with fisheries through their predation on the larvae of commercial fish species (Purcell et al. 1994, 2014, Purcell and Arai 2001, Sabatés et al. 2010) and competing with juvenile fish for food (Purcell and Grover 1990, Purcell and Arai 2001). Revenues from fisheries in Catalonia are declining with a current value of around €110 million (IDESCAT 2010) (Fig. 23). The majority of landings are from small pelagic fisheries: sardine (*Sardina pilchardus*) and anchovy (*Engraulis encrasicolus*) account for around 50% of total annual landings in Catalonia as well as generally in the Mediterranean (Leonart and Maynou 2003, Palomera et al. 2007, IDESCAT 2010) (Fig. 24).

Fig. 23: Tourism and fisheries revenues, Catalonia

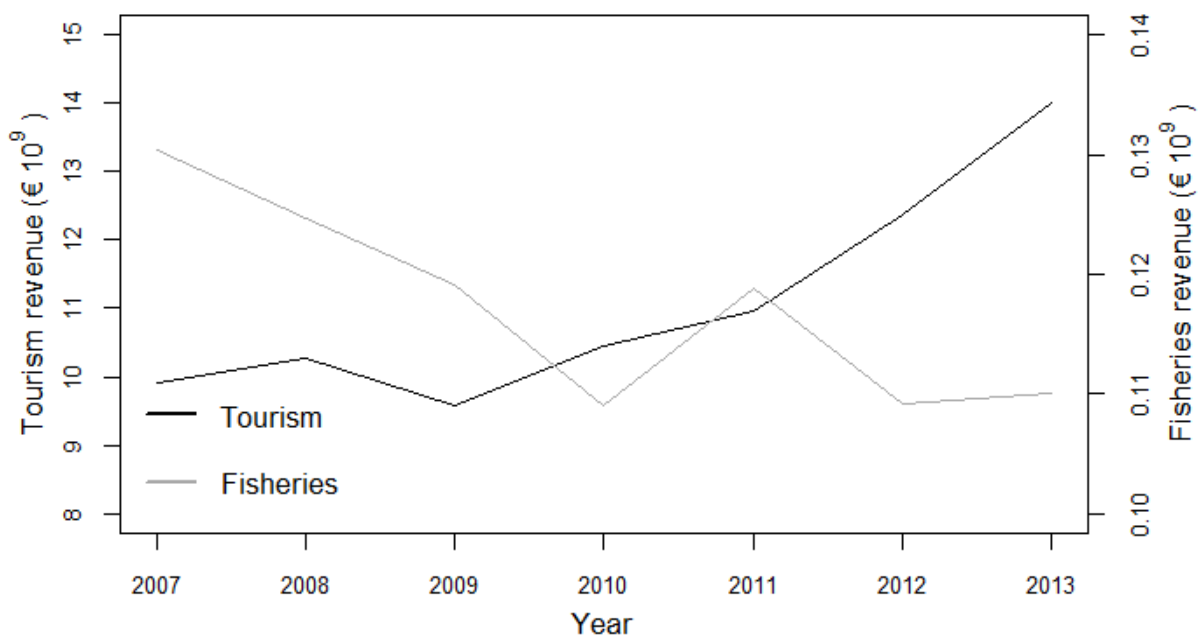
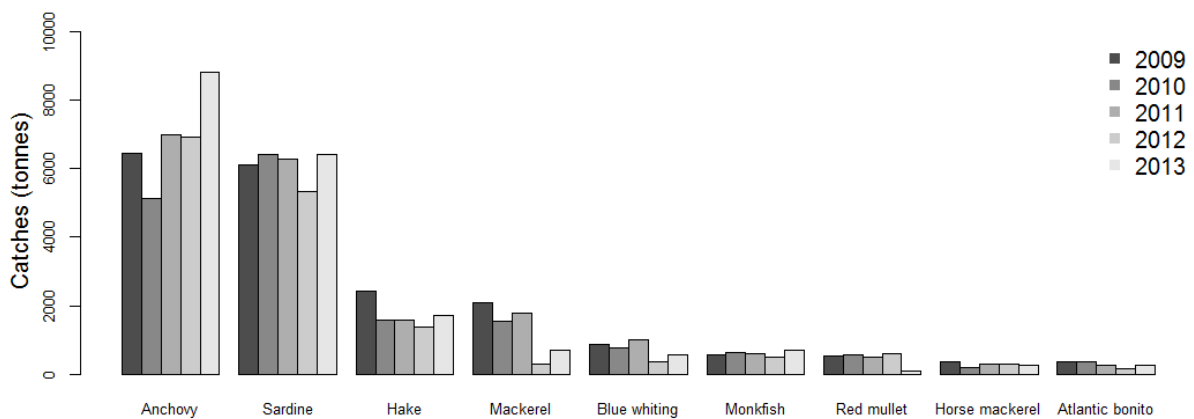


Fig. 24: Catches by species, Catalonia



The scientific team believed the impact of jellyfish on these social ecosystems would be of interest to numerous stakeholders, especially those involved in managing beaches, tourism, and fisheries. It was also thought there was sufficient data and knowledge to be able to construct a model capable of representing these issues accurately so the scientific team decided to proceed with designing a conceptual model. The hypothesis is that an increase in *P. noctiluca* in the coastal waters of Catalonia would: decrease the catches of the small pelagic fisheries; increase the number of *P. noctiluca* stranding events on Catalan beaches.

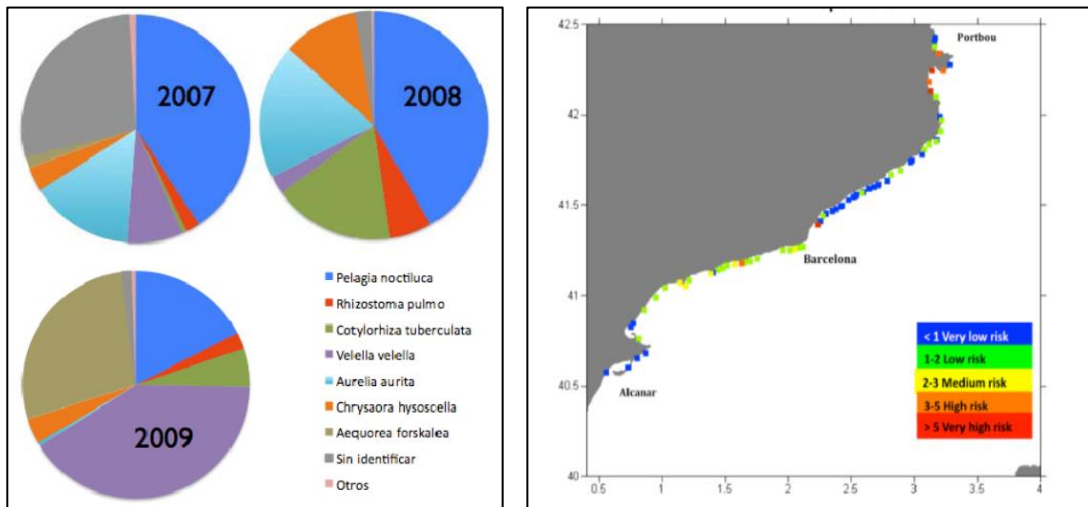
### 3.3 System Design

From this background knowledge, a general conceptual model had been formed where jellyfish had an impact on the small pelagic fisheries and tourist industry which would have a wider effect on the regional economy. The research team proposed to investigate the extent of each impact on each sector for a given change in jellyfish levels. This conceptual model also fulfilled the requirements of the project work task in which knowledge would be used from previous work tasks.

However, many specifics, conditions and boundaries had yet to be determined. During the scientific team's deliberations regarding the model, it became clear that one species of jellyfish would be focused upon: *Pelagia noctiluca* is common along the Catalan coastline and there is a relatively large data set regarding its presence and/or population; there were documented effects of predation upon anchovies (Sabatés et al. 2010); and it has a powerful sting which impacts on beach users. There are other species of jellyfish in the area but they are not as well studied and documented so were excluded from the model.

Stranding risk of all jellyfish is shown in Fig. 25. There is a general trend where, heading from north to south, there is a high risk of strandings near Cap de Creus which decreases to a low risk as we approach Barcelona. Heading further south towards the Ebro Delta we see that the stranding risk increases again but not to the same extent as in the far north. It was decided that these three risk zones would be the basis for the model where calculations (for jellyfish and fisheries) would be made for each zone separately. This would be necessary in order to capture the difference in strandings across Catalonia. The three zones are called Girona, Barcelona and Tarragona after their adjacent provinces (see Fig. 27 below).

Fig. 25: Observations of jellyfish by species and location in Catalonia (Technical report Jellyfish Observation Campaign 2007-2009. ICM CSIC-Catalan Water Agency)



The small pelagics were chosen as the focus for the fisheries component of the model for the following reasons: they are the largest fisheries in Catalonia; the evidence of predation by *P. noctiluca* upon anchovies; and the existence of a bio-economic model that could be adapted for the small pelagics. It should be noted that there is no evidence of predation by *P. noctiluca* upon sardines (due to the lack of scientific studies undertaken in winter when sardines spawn), but they form part of the same fisheries, and so were included in the model. Small pelagic fisheries are common along the entire Catalan coast with the exception of Cap de Creus and the Ebro Delta so these are considered the boundaries of the model (parallel to the coast). Small pelagics are fished in the area from the coastline (35 m depth) to the shelf break (200 m depth) so this is considered the boundary perpendicular to the coast. Within this SAF application, the three zones (Girona, Barcelona and Tarragona) are collectively referred to as Catalonia although it should be remember that this does not include Cap de Creus and the Ebro Delta. The approximate areas of each zone, Girona, Barcelona and Tarragona are 3200 km<sup>2</sup>, 3800 km<sup>2</sup> and 2800 km<sup>2</sup>.

There was a proposition of including an additional zone further off the coast in the open sea populated by *P. noctiluca* (although no fishing would occur there). *P. noctiluca* could migrate from this zone to any of the three coastal zones depending on hydrodynamic conditions. Similarly, it was initially planned that there could be migration between the coastal zones parallel to the coast. However, although it is known the *P. noctiluca* exist there, there is a scarcity of data regarding this so the conceptual model was simplified in which there are three separate zones which are populated by the small pelagics and *P. noctiluca*, and there is no migration between them. These limitations will

be discussed further in Chapter 3.7.1. The final conceptual model and location of study zones are shown in Figs. 26 and 27.

Fig. 26: Conceptual model of VECTORS application model

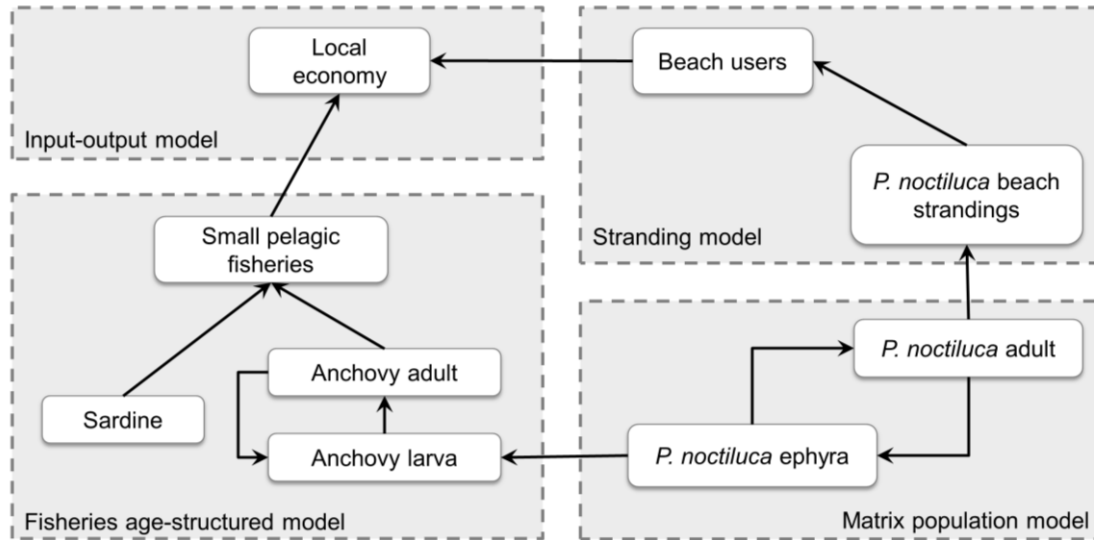
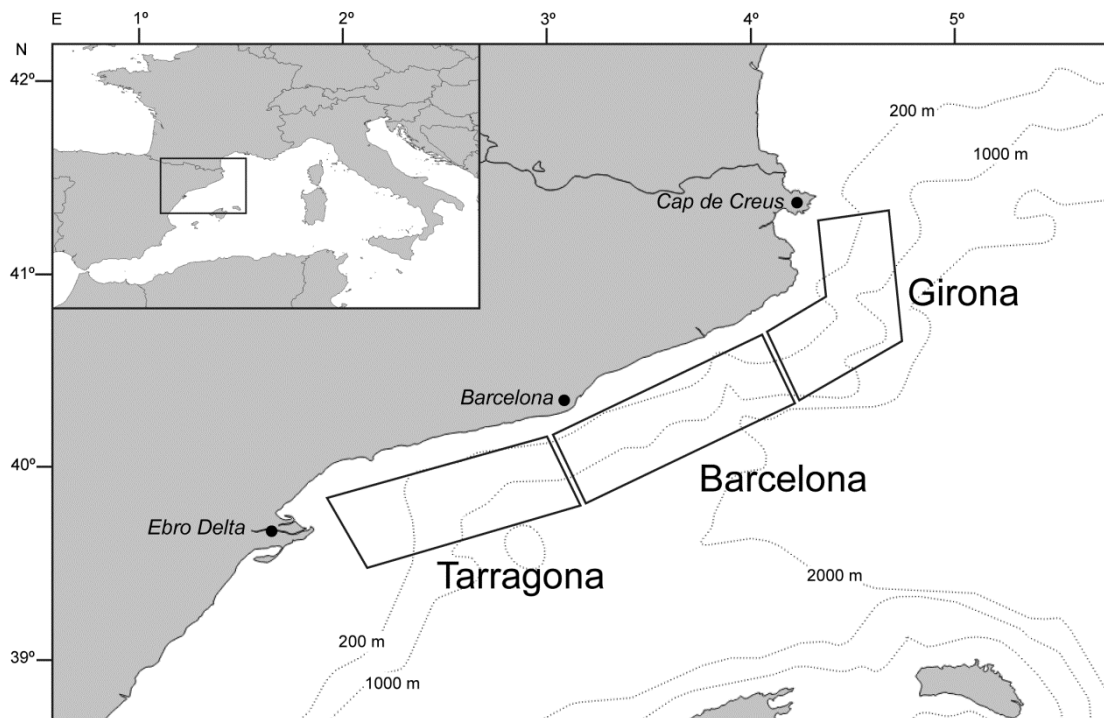


Fig. 27: Map of the three zones defined in VECTORS application model



### 3.4 System Formulation

The model consists of four sub-models which will be described each in turn in this section. In order to construct each sub-model, a brief review of the existing models in that category was undertaken, analysing the advantages and disadvantages of each. This was followed by a selection process in which the most suitable model was chosen. In some cases, there was only one suitable model so the selection process was automatic.

#### 3.4.1 Fisheries sub-model

##### 3.4.1.1 Review of available fisheries models

Fisheries modelling has existed for over 100 years ever since early pioneers such as Petersen (1896) tried to quantify the size of a fish stock, Baranov (1918) calculated population size using natural and fishing mortality, and Hjort (1914) began to use age-structured models. It is beyond the scope of this study to write an exhaustive history of fisheries modelling (Smith 2002). Instead I'll present some of the models considered by the scientific team and the advantages and disadvantages of each. If the reader would like an in-depth analysis of the most commonly used fisheries model currently in use, especially in the context of an ecosystem approach to fisheries then I recommend Plagányi (2007) produced for the Food and Agriculture Organization of the United Nations (FAO).

When deciding which model would be the most suitable for the needs of a given study, there are many criteria which should be considered. When comparing the currently available models, Plagányi (2007) used the following criteria:

- *the level of complexity and realism, e.g. the number of modelled species, the representation of size/age structure of the species, and the types of processes represented (physical and biological);*
- *the types of functional responses of predators to changes in abundance of prey species and their consequences and limitations;*
- *how uncertainties in model structure, parameters and data are treated;*
- *how environmental effects and interactions with non-target species (e.g. marine mammals; sea turtles; sea birds) are incorporated;*
- *the spatial representation of species interactions and habitat related processes;*

- *model suitability for dealing with migratory species, i.e. species that cross ecosystem boundaries;*
- *where possible, model adequacy to allow the analysis of the different types of management controls in use, such as effort control, minimum size, total allowable catch, protected areas and closed seasons;*
- *model adequacy to allow the assessment of the effects of short, medium and long- term ecosystem changes;*
- *model suitability to conduct assessment and policy exploration, considering the model's potential use to conduct historical reconstruction of resources to describe the current status of the ecosystem and to evaluate the potential effects of various kinds of decisions (short and long term);*
- *model transparency of operation and ease of use;*
- *data requirements and model suitability for data poor areas.*

(Plagányi 2007)

#### 3.4.1.1.1 Minimally realistic models

Fisheries models can be broadly split into one of two categories – either *Minimally realistic model* (MRM) (as coined by Butterworth et al. (1991)) or *Ecosystem models*. A MRM will only model the target (individual or multiple) species which are of interest to the study in question. This means they are generally system specific; only a small section of the ecosystem is modelled; and lower trophic levels and primary production are constant or vary stochastically but are not dynamic within the model. They are also referred to as *Dynamic multi-species models* when more than one species is modelled.

There are many examples of such models, each varying in scope, objective, complexity and usability.

A few key examples include:

- Boreal Migration and Consumption model (BORMICON) (Stefánsson and Pálsson 1997, Stefansson and Palsson 1998)
- Globally applicable Area Disaggregated General Ecosystem Toolbox (GADGET) (Begley and Howell 2004, Trenkel et al. 2004, Andonegi et al. 2011)
- Mediterranean Fisheries Simulation Tool (MEFISTO) (Lleonart et al. 1998, 2003, Maynou et al. 2006)

- Multi-species Virtual Population Analysis and Multi-species Forecasting Model (MSVPA and MSFOR) (Helgason et al. 1979, Pope 1991, Stokes 1992, Magnússon 1995)
- Multi-species model for the Barents Sea (MULTISPEC) (Bogstad et al. 1992, 1997, Tjelmeland and Bogstad 1998)

A key feature of the MRMs mentioned above is the low number of modelled species or groups, typically between 1 and 4, with the exception of MSVPA and MSFOR which usually models around 6-8. The unit for the models mentioned above are all biomass – compared to some Ecosystem models described below which use nutrient pools. They can all model detailed representations of age structure but not physical and biological processes, with the exception of MULTISPEC and GADGET which can be linked to oceanographic circulation models.

MSVPA and MSFOR, MULTISPEC, and MEFISTO use an *efficient predator* model where the predator is always able to consume its necessary resources of various prey species. The alternative is a *hungry predator* model where species compete with each other for limited resources. GADGET is an example of both an efficient and hungry predator model, depending on the way in which it is configured. These MRMs have no, or only minor, interactions with non-target species. Of these models only MULTISPEC and GADGET are spatially explicit, with specific parameters and variable for a given zone, and the possibility of migration of species between them. They all allow the analysis of various management controls such as limiting catches (spatially or temporally) and gear types, however they are poor at allowing the assessment of effects of ecosystem changes. Detailed stomach content data is necessary for MSVPA and MSFOR and MULTISPEC which makes it difficult to implement in areas without this. MEFISTO and GADGET are not so data intensive and can be adjusted to the data available.

#### 3.4.1.1.2 Ecosystem models

*Ecosystem models*, on the other hand, have been designed to include most ecosystem components, and capable of including lower trophic levels and primary production. Various subsets of this genre occur with subtle differences between them: *Whole ecosystem models* try to simulate all the trophic levels of the ecosystem, whereas *Dynamic system models* try to include both the physical and biological forces interacting in an ecosystem. Often the classification into one of these sub-types depends on the way a specific model is constructed.

Examples of Ecosystem models include:

- ATLANTIS (Fulton et al. 2004a, 2004b, 2005)
- ECOPATH with ECOSIM (EwE) (Polovina 1984, Christensen and Pauly 1992, Walters et al. 1997, 2000, Christensen and Walters 2004)
- European Regional Seas Ecosystem Model (ERSEM) (Baretta et al. 1996, Baretta-Bekker and Baretta 1997)
- Spatial Ecosystem and Population Dynamics Model (SEAPODYM) (Bertignac et al. 1998, Lehodey et al. 1998, 2003, Lehodey 2001)
- Object-oriented Simulator of Marine ecosystem Exploitation (OSMOSE) (Shin 2001, Shin and Cury 2004)

In general, *Ecosystem models* model large numbers of species or groups – typically in the range of 10-30, although sometimes many more as is the case with the ATLANTIS where one implementation includes up to 61 groups (Kaplan et al. 2012). An exception from those mentioned above is the SEAPODYM which currently only explicitly models 3 tuna species. The model units for ATLANTIS and ERSEM are nutrient pools whereas the other models all use biomass. OSMOSE and SEAPODYM use an *efficient predator* model whereas ATLANTIS, ERSEM and EwE are *hungry predator* models (see Chapter 3.4.1.1.1 for definition). All these models can be age-structured (for vertebrates) and use aggregated biomass pools for primary producer groups. ATLANTIS is driven by physical and biological processes such as irradiance, temperature, nutrient inputs from point sources and boundary conditions. ERSEM needs light and temperature forcing functions. SEAPODYM can be coupled to biological and physical models but typically a time series of environmental data is used instead. EwE can include biological and physical process but only to a limited extent, whereas OSMOSE does not. ATLANTIS can represent discard and bycatches of target and non-target species well, but EwE only implements them to a lesser extent. The other models do not include this possibility. All these models include the interaction with non-target species (in the case of EwE and ATLANTIS this interaction is often the objective of the study) with the exception of ERSEM and SEAPODYM. ATLANTIS, OSMOSE and SEAPODYM are spatially explicit (for species interactions) whereas EwE and ERSEM are not, although ERSEM is spatially explicit for transport of plankton groups. ATLANTIS and SEAPODYM can handle the migration of species between cells whereas the others cannot. Unlike the other models mentioned above, EwE, ATLANTIS and SEAPODYM all include the possibility of allowing various management controls. ATLANTIS, ERSEM and SEAPODYM are all highly data intensive making them not suitable for data poor studies. EwE does not require as much as biogeochemical data as



these, but it does need hard-to-acquire data such as diet composition and species abundance estimates. OSMOSE is based on fairly general parameters and therefore the easiest to implement.

Of all these MRM and Ecosystem models, the most widely used is EwE in part thanks to its user-friendly interface, and continues to be improved, for example in its improvements to handle age-structured groups. GADGET is often considered to be the most useful in terms of modelling management practices such as total allowable catches. ATLANTIS is considered the best model within a simulation testing framework although is difficult to implement due its data-intensive requirements. Models such as EwE and ATLANTIS are more useful for broad-scale questions such as the functioning of an ecosystem, whereas MRMs are generally more appropriate for analysing impacts on one specific target species. It is clear that no one model is the “best” and we have to look at our needs and available resources (data and time).

#### 3.4.1.2 Selection of fisheries sub-model

With the increase in computational power and an emphasis on the ecosystem approach to fisheries, ecosystem models are becoming more popular. However they take longer to implement, are data intensive and are therefore often impeded by inaccurate parameter estimation. A complete representation of the entire ecosystem may not be necessary depending on the objectives of the model application. The model used should only be as complex as is necessary to capture the key interactions within an ecosystem. Including more species-groups should increase the realism of the representation of the ecosystem but this assumes that all the parameters can be accurately estimated. Reducing some of these groups might not necessarily reduce the predictive accuracy of a given model if the model parameters are estimated robustly. For example in a model of the Benguela ecosystem, Yodzis (1998) found that any link that represents less than 10% of consumption (either as predator or prey) could be removed without affecting the overall outcome of the model.

As can be seen from this brief review of a few of the available fisheries models, there are many similarities and differences between them. To decide which model would be the most suitable for our study, we need to look at our requirements for the investigation, the available data and expert knowledge, and the capacity to program the chosen model.

The fisheries sub-model would need to have the following characteristics:

- Dynamic representation of anchovies and sardines – individual and population growth, natural and fishing mortality, recruitment.
- Monthly temporal resolution – necessary in order to capture the predation of *P. noctiluca* upon the small pelagic larvae
- Spatially explicit - three zones would be required (for the jellyfish stranding sub-model) although it would be possible to simply run the same model for each zone with the relevant parameters, as there is no migration between the three zones
- Calculate economic benefits (landings) and costs of small pelagic fisheries
- Trophodynamic modelling not necessary – small pelagics have a trophic level of around 3, feeding on zooplankton and phytoplankton, and the factors that most influence their abundance are fisheries and sea surface temperature (Palomera et al. 2007)
- No ecosystemic changes – predation of *P. noctiluca* on the small pelagics has not caused a systemic change in the trophic structure
- The model has to be implemented relatively quickly – it is one sub-model of a larger model

A review of relevant models already implemented in or near the study zone are listed below:

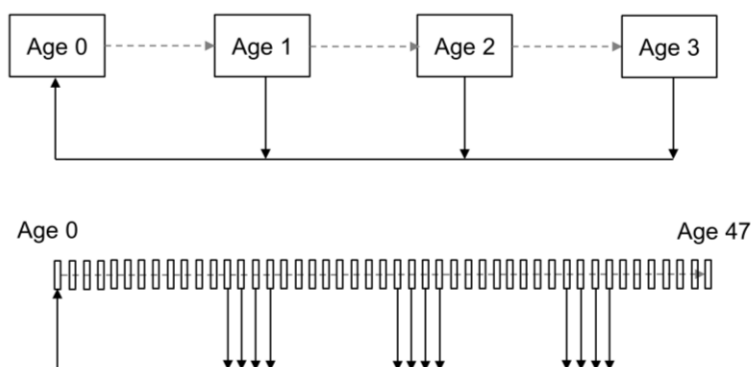
- MEFISTO – Hake in the Catalan Sea (Lleonart et al. 2003)
- MEFISTO – Red shrimp in the Catalan Sea (Maynou et al. 2006)
- MEFISTO – Demersal and pelagic species in Western Mediterranean (Maynou 2014)
- EwE – 40 functional groups in South Catalan Sea (Coll et al. 2006)

Following a discussion among the scientific team, it was decided that no one model was perfect for our needs. There was an initial interest in either attempting to implement EwE or ATLANITS models for the study but it became clear that both models would take a long time to construct and there was probably not enough data for either. The model would become dependent on adjusting many unknown parameters to achieve a stable output, without the certitude that the parameters reflected the reality of the system. There was also not much need for an entire ecosystem model as the primary point of interest was the impact of jellyfish on the small pelagic fisheries.

The most suitable model for this study would be the MEFISTO model although a few alterations would have to be made – principally the temporal resolution. In previous implementations,

MEFISTO ran at a time-step of one year, which would be insufficient to catch the predation of *P. noctiluca* on the small pelagic larvae which only occur for a few months each year (anchovies in summer, sardines in winter). Our fisheries sub-model would therefore have to run at a time-step of one month. Additionally, the reproduction or recruitment models would have to be altered. MEFISTO uses a recruitment function where each cohort produces a number of fish with age 0 (years) the following year. In our model fish would produce larvae (at certain months of the year) with age 0 (months), and with each time-step (of 1 month) the larva would become 1 month older turning into juveniles and then mature adults (each with specific parameters related to their maturity, natural mortality and fishing mortality). The difference in time-step and recruitment between MEFISTO and our fisheries sub-model is shown in Fig. 28 for a hypothetical fish that only spawns four months a year, with a lifespan of four years. Note that each reproduction arrow for each age class has its own unique value for both models.

Fig. 28: Recruitment model for MEFISTO and fisheries sub-model



An additional problem was the lack of spatial dimension to MEFISTO. In order to model jellyfish stranding in three separate zones, the interaction with the fisheries would also need to be modelled in the same zones. Although there is probably migration of small pelagics along the Catalan coast, there is not exact data to model this. So for simplicity, it was decided that the model would be repeated for each zone with no migration. In the event that further data becomes available, migration between the zones could be included.

MEFISTO was designed to predict future landings and fish populations for given management decisions such as limiting effort, altering selectivity regulations or changes to subsidies and taxes. The objective of our model is to analyse the impact of *P. noctiluca* predation on small pelagic

fisheries. So certain aspects of MEFISTO could be simplified. For example, stochastic elements from the growth and mortality equations were removed; and the *market* and *fisherman boxes* were excluded. This would help clarify the impact just of the *P. noctiluca* in the event that all else is static.

### 3.4.1.3 Fisheries sub-model description

The following equations describe the fisheries sub-model. Note that  $a$  and  $t$  (age and time) both have the same unit - months. So at each time-step in the model (one month), the cohort ages by one month – i.e.  $a$  and  $t$  both increase by 1. In our study, these equations are calculated six times for each time-step (month) - once for each of the three zones ( $v$ ), and once for each of the two target species ( $i$ ) (sardines and anchovies) within each zone. See Appendix X for a table of the symbols, definitions and units for the model parameters and variables.

The number of individuals at age  $a$  (in months) for a given cohort, at time  $t$  is defined by:

$$N_{a+1,t+1} = N_{a,t}e^{-Z_{a,t}}$$

$Z_{a,t}$  is the total mortality (per month) for a cohort with age  $a > 0$  at time  $t$ :

$$Z_{a,t} = \frac{F_{a,t} + M_{a,t}}{12}$$

$F_{a,t}$  is the fishing mortality and  $M_{a,t}$  is the natural mortality for a cohort with age  $a$  at time  $t$ .

In the case where  $a = 0$ , *before* calculating the growth in population, there is predation by *P. noctiluca* on the larvae (i.e. fish at age 0):

$$N_{0,t} = N_{0,t} - J_t$$

Where  $J$  is the consumption of fish larvae by *P. noctiluca* at time  $t$ . (See Chapter 3.4.2 for further details on the jellyfish sub-model). Note at  $a \neq 0, J = 0$ .

The average number of individuals during age  $a$  is therefore calculated by:

$$\bar{N}_{a,t} = N_{a,t} \frac{1 - e^{-Z_{a,t}}}{Z_{a,t}}$$

*(Note that in this model there are no discards, and catchability is ignored (given a value of 1) so fishing effort = fishing mortality.)*

Using the von Bertalanffy equation for individual growth:

$$l_a = L_{\infty}(1 - e^{-k(a-t_0)})$$

The relative growth in weight (grams) is given by:

$$w_a = A \cdot l_a^B$$

The mean biomass (tons) for an age-class cohort  $a$  is (converted from grams to tons):

$$\bar{B}_{a,t} = \bar{N}_{a,t} \bar{w}_a \times 10^{-6}$$

So the total mean biomass for the whole stock is:

$$\bar{B}_t = \sum_{a=1}^m \bar{B}_{a,t}$$

where  $m$  is the maximum age (in months).

The catch (tons) of a cohort with age  $a$  at time  $t$  is:

$$C_{a,t} = \frac{F_{a,t} \bar{B}_{a,t}}{12}$$

(Fishing mortality converted from yearly to monthly rate)

So the total catch at time  $t$  is:

$$C_t = \sum_{a=1}^m C_{a,t}$$

The total catch for a *year* is therefore:

$$Cy_T = \sum_{t=2T}^{2T+11} \sum_{a=1}^m C_{a,t}$$

Where  $T$  is the time in years.

The spawning stock biomass (SSB) (tons) is calculated as a function of mean biomass and proportion of mature fish ( $G_{a,t}$ ) for a given age  $a$  at time  $t$ .

$$SSB_{a,t} = \bar{B}_{a,t} G_{a,t}$$

The SSB for all age classes with a maximum age  $m$  is:

$$SSB_t = \sum_{a=1}^m SSB_{a,t}$$

The SSB for all age classes for a given year  $T$  is:

$$SSBy_T = \sum_{t=2T}^{2T+11} \sum_{a=1}^m SSB_{a,t}$$

In MEFISTO and other fisheries models, the SSB is used to calculate recruitment at time  $t+1$  for a population at time  $t$  using equations based on SSB – recruitment possible functional relationships such as *Constant recruitment*, *Beverton and Holt's model* or *Ricker's model* (Myers 2002). As previously explained, these equations are not adequate for our fisheries sub-model where the time-step is one month (as opposed to one year), and the number of larvae produced is required so that the effect of predation by *P. noctiluca* can be included. The (yearly) SSB is calculated in this model because it is a common metric output of other models, and therefore is included here too.

Reproduction of the population is calculated for every  $t$ , creating new members of the population with  $a = 0$ .

$$N_{0,t} = \sum_{a=1}^m N_{a,t} \cdot S_a \cdot s_{t \bmod 12 + 1}$$

Where  $S$  is the fecundity (defined here as the number of larvae produced at  $t + 1$ ) of the species at age  $a$ , and  $s$  is a modifier of the fecundity depending on the month of the year where

$$s_T = \sum_{t=2T}^{2T+11} s_{t \bmod 12 + 1} = 1, \quad \forall T$$

(Note that the modifier  $s$  assumes that the model simulation starts in January at  $t = 0$ . If the simulation is started in a different month, this must be adjusted accordingly).

Revenue ( $P$ ) (euros) for each fleet ( $v$ ) and species ( $i$ ), where there is one fleet per zone is:

$$P_v = 1000 \sum_{i=1}^I C_i p_i$$

Where  $I$  is the number of species,  $C$  is the catch (tons) and  $p$  is the price (€/kg) per species.

Therefore revenue for all fleets (and all zones ( $V$ )) for a given year ( $T$ ) is:

$$Py_T = 1000 \sum_{t=2T}^{2T+11} \sum_{v=1}^V \sum_{i=1}^I C_i p_i$$

Costs (euros) are based on the descriptors from the 2013 Annual Economic Report of European Union Fisheries (Anderson and Carvalho 2013), adapted to the economic costs model of MEFISTO (details in Maynou et al. (2006)).

Total monthly costs  $Co$  are the sum of the following six variables,  $Co1$  to  $Co6$ :

$$Co_v = Co1_v + Co2_v + Co3_v + Co4_v + Co5_v + Co6_v$$

The *trade costs*,  $Co1$ , for each fleet  $v$  are calculated as a percentage of revenues, to pay for VAT, fisherman association taxes, labour taxes and other local taxes.

$$Co1_v = c1_v \cdot P_v$$

The *daily costs*,  $Co2$  relate to expenses incurred daily such as fuel, food and repairing fishing apparatus are calculated as a function of effort.

$$Co2_v = \frac{NFD_v}{12} (fp_v \cdot fc_v + ice_v + oDC_v)$$

The *labour costs* depend on the revenues and trade and daily costs. The value  $c3$  is the percentage of the profits that is given to the crew (and the rest to the owner of the vessel) known as the “*monte menor*” in Spanish.

$$Co3_v = c3_v (P_v - Co1_v - Co2_v)$$

*Compulsory costs* ( $Co4$ ) are those fixed annual costs which are not dependent on fishing effort such as harbour costs, licences, insurance. *Maintenance costs* ( $Co5$ ) are those variable costs which are needed to keep the vessel in good working order. They are both expressed as a percentage of total *annual costs*.

$$Co4_v = \frac{annualC}{12} \cdot percFC$$

$$Co5_v = \frac{annualC}{12} \cdot percVC$$

The opportunity cost is the forgone cost of deciding to invest the capital in fishing activity instead of some other mutually exclusive activity.

$$Co6_v = \frac{1}{12} \cdot c6 \cdot K_v$$



The fisheries sub-model input data can be found in Appendix XI.

### 3.4.2 Jellyfish sub-model

#### 3.4.2.1 Review of available jellyfish models

There exist few ecological models considering jellyfish dynamics despite increasing calls for them to be included in marine ecosystem models (Pauly et al. 2009, Richardson et al. 2009). This is likely caused by a number of factors such as lack of knowledge and data as well as the separation of jellyfish scientists and fisheries scientists (Pauly et al. 2009).

Ecopath with Ecosim models have sometimes included jellyfish, but normally individual species are not identified and are aggregated to a single functional group, with the notable exceptions of Trites et al. (1999) and Walters et al. (2005). EwE models balance the flow of mass to analyse changes in the ecosystem. Whereas most EwE models use wet weight biomass in their calculations, jellyfish are normally recorded in databases such as SeaLifeBase and Fishbase as dry weight. Pauly et al. (2009) state that the parameters of Jellyfish in EwE models (such as consumption per biomass) are unacceptably variable, possibly due to inconsistencies in reporting jellyfish as dry or wet mass. This may be caused by the incorrect use of wet-biomass specific parameters which are biased for jellyfish as the majority of their “biomass” consists of water. These inconsistencies prohibit the easy implementation of jellyfish within EwE models. As previously discussed in Chapter 3.4.1.2, the scientific team thought that the implementation of an EwE model would be difficult for our study site given the lack of available data and knowledge uncertainties.

In contrast to these EwE models which try to include the dynamics of jellyfish within the ecosystem, other studies have implemented models where changes in the jellyfish population are autonomous. A matrix population model was used to model *Pelagia noctiluca* in the Gulf of Trieste (northern Adriatic Sea) by Malej and Malej (1992). Matrix population models are used where a given population grows within an unlimited environment using matrix algebra.

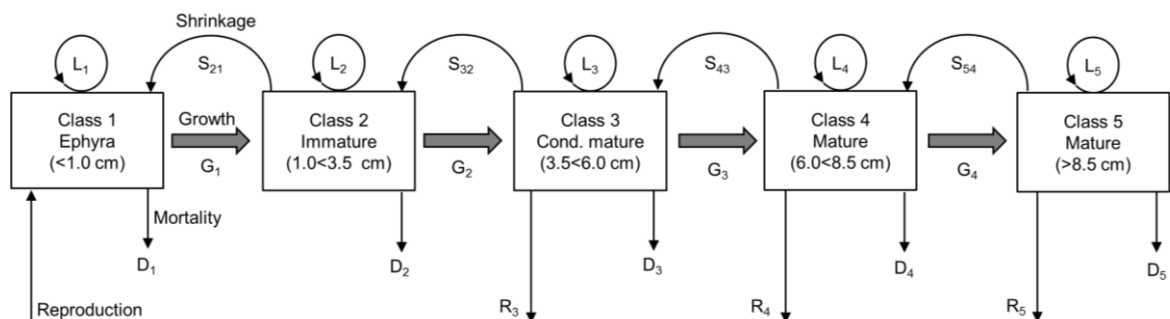
A population  $N$  at time  $t$  can be modelled using the standard population equation, referred to as the BIDE (Births Immigration Death Emigration) model:

$$N_{t+1} = N_t + \text{births} - \text{deaths} + \text{immigration} + \text{emigration}$$

The population is divided into groups (*classes*), either as a discrete age-structured model known as a Leslie matrix (Leslie 1945), or as a life stage model – a Lefkovitch matrix (Lefkovitch 1965). The population can *grow* to the next class, stay in the same class (*loop*), *shrink* to the previous class, or die. These value of births, deaths, immigration, emigration, grow, loop and shrink are specific to each *class* of the population, and will therefore implicitly include information of the ecosystem in which they populate. A projection matrix is built which explicitly and implicitly includes all this information. At each time-step  $t$ , the population vector (number of individuals in each class) is multiplied by the projection matrix to produce the population vector at time  $t+1$ .

Malej and Malej (1992) constructed their *P. noctiluca* matrix population using a modified Leslie matrix with a time-step of one month. The graphical presentation of the model is shown in Fig. 29. Each class is based on the size of the diameter of the jellyfish. Class 1 can grow ( $G_1$ ), loop ( $L_1$ ) or die ( $D_1$ ). The other classes can also shrink (e.g. Class 2 to class 1 -  $S_{21}$ ). Additionally only mature ( $\geq$  Class 3) jellyfish can reproduce (e.g. Class 3 –  $R_3$ ). It is assumed that each class can only grow or shrink by one class in each time-step (month). There is also neither immigration nor emigration.

Fig. 29: Graphical representation of *P. noctiluca* matrix model (Malej and Malej 1992)



This graphical representation of the model is represented as matrix algebra as shown in Fig. 30. The population of each class ( $n_t$ ) is then multiplied by the projection matrix ( $M$ ) at time  $t$  to calculate the projection matrix at time  $t+1$  ( $n_{t+1}$ ). The values for loop ( $L$ ), growth ( $G$ ) and shrinkage ( $S$ ) are the proportion for each class which either stay in their class (loop) or leave their class (shrinkage or growth). Note that mortality ( $D$ ) is not explicitly declared in the matrix, but can be calculated as the proportion of the class that do not loop, grow or shrink – i.e. subtract from 1 the sum of probabilities of a column of  $M$  (excluding reproduction  $R$ ). For example the mortality for Class 2 ( $D_2$ ) is calculated as:

$$D_2 = 1 - (G_2 + L_2 + S_{21})$$

Fig. 30: Projection Matrix of the *P. noctiluca* matrix model (Malej and Malej 1992)

$$M \cdot n_t = n_{t+1}$$

$$\begin{bmatrix} L_1 & S_{21} & R_3 & R_4 & R_5 \\ G_1 & L_2 & S_{32} & 0 & 0 \\ 0 & G_2 & L_3 & S_{43} & 0 \\ 0 & 0 & G_3 & L_4 & S_{54} \\ 0 & 0 & 0 & G_4 & L_5 \end{bmatrix} \begin{bmatrix} n_{1t} \\ n_{2t} \\ n_{3t} \\ n_{4t} \\ n_{5t} \end{bmatrix} = \begin{bmatrix} n_{1t+1} \\ n_{2t+1} \\ n_{3t+1} \\ n_{4t+1} \\ n_{5t+1} \end{bmatrix}$$

Whereas most matrix models keep the matrix coefficients fixed, Malej and Malej (1992) adapted their model to reflect temporal changes so that the jellyfish only reproduced from April to November, with a change in reproduction rate between spring and summer-autumn. Their final matrix model with the coefficients for each season is shown in Fig. 31:

Fig. 31: Projection matrices with coefficients for each season (Malej and Malej 1992)

$$\text{Spring (April - May)} \quad \begin{bmatrix} 0 & 0 & 0.30 & 0.70 & 0.75 \\ 0.60 & 0.15 & 0.10 & 0 & 0 \\ 0 & 0.65 & 0.30 & 0.10 & 0 \\ 0 & 0 & 0.45 & 0.55 & 0.10 \\ 0 & 0 & 0 & 0.15 & 0.10 \end{bmatrix}$$

$$\text{Summer-autumn (June - November)} \quad \begin{bmatrix} 0 & 0 & 0.50 & 0.80 & 0.85 \\ 0.60 & 0.15 & 0.10 & 0 & 0 \\ 0 & 0.65 & 0.30 & 0.10 & 0 \\ 0 & 0 & 0.45 & 0.55 & 0.10 \\ 0 & 0 & 0 & 0.15 & 0.10 \end{bmatrix}$$

$$\text{Winter (December - March)} \quad \begin{bmatrix} 0 & 0 & 0 & 0 & 0 \\ 0.60 & 0.15 & 0.10 & 0 & 0 \\ 0 & 0.65 & 0.30 & 0.10 & 0 \\ 0 & 0 & 0.45 & 0.55 & 0.10 \\ 0 & 0 & 0 & 0.15 & 0.10 \end{bmatrix}$$

### 3.4.2.2 Selection of jellyfish sub-model

For our model, the jellyfish sub-model needed to fulfil the following criteria:

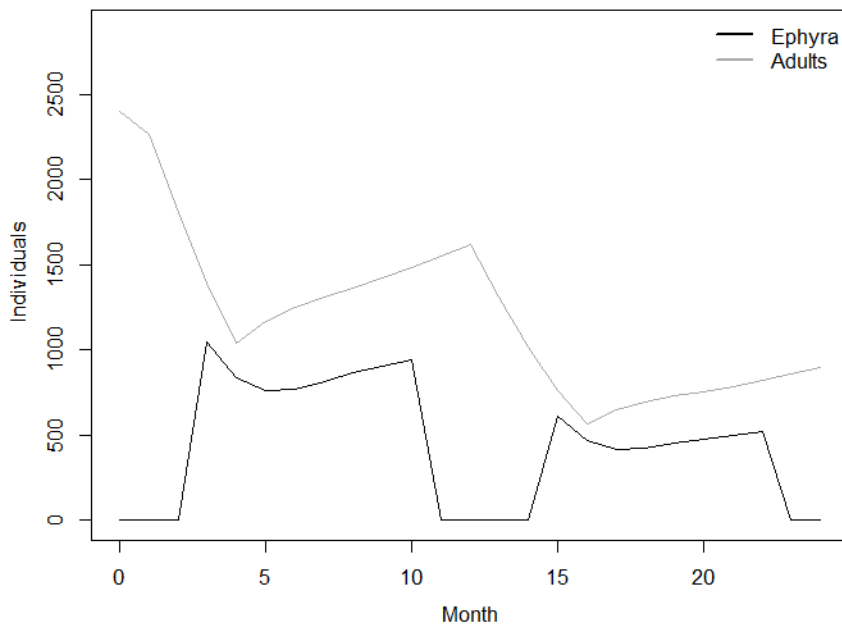
- Model the population dynamics of *P. noctiluca* throughout the year with a monthly time-step
- Include the ephyra life stage as a separate class – this is the stage that has been documented as feeding on anchovy larva
- Spatially explicit across three zones
- Possible migration between zones
- The ability to vary bloom size from year to year - to analyse impact of possible increases (or decrease) in population levels on fisheries and beach strandings.

An EwE model would need to be implemented as an ecosystem model including the fisheries sub-model. However, due to the same considerations when deciding upon the fisheries sub-model, an EwE model was deemed to be too complex for the needs of the project whilst also problematic in parameterisation. The matrix population was considered as more appropriate although there would have to be some adaptations to fulfil the required criteria. Apart from being able to model the ephyra class (a necessary requirement), there was also the advantage that the model designed by Malej and Malej (1992) analysed the same species of jellyfish as our model. Disadvantages in using the matrix population model would be the inability to analyse ecosystemic effects. These changes and limitations will be discussed further in the Jellyfish sub-model description.

### 3.4.2.3 Jellyfish sub-model description

The model by Malej and Malej (1992) was reproduced and analysed and a sample output for ephyra *P. noctiluca* (class 1) and mature adult (classes 3-5) *P. noctiluca* for one year is shown in Fig. 32. The model predicts that Ephyra are relatively constant from April to November with a slight decrease in June, but are completely absent the rest of the year. Mature adults are highest in January and decrease until May when they start to recover and increase every month until January. This dynamic does not reflect the situation in the Western and Central Mediterranean where adult pelagic cnidarians are most numerous during spring and early summer and decrease thereafter (Gili et al. 1987, Rosa et al. 2013).

Fig. 32: Population dynamics of *P. noctiluca* ephyra and mature adults from the Malej and Malej (1992) model



An additional problem in the possible use of the Malej and Malej (1992) model is the non-isolation of the ephyra stage from smaller stages. Anything smaller than 1.0 cm was classed as “ephyra” implying that mature adults directly produce the ephyra stage with no intervening stage. In reality mature *P. noctiluca* adults produce eggs which develop into the planula stage. The planula develop into ephyra followed by immature medusa and finally mature medusa. Unlike many cnidarians, there is not a polyp stage.

For these reasons it became clear that a new population matrix model was required, adding a lower level class before ephyra, and re-parameterising the other coefficients. For our needs there was not much need to distinguish the jellyfish by size, whereas it was important to identify the various life stages of the jellyfish, therefore a Lefkovitch matrix model would be used (instead of a Leslie matrix). Lefkovitch matrix models are also advantageous when it’s difficult to determine the age of an individual and birth and death rates are dependent on the stage rather than age (Lefkovitch 1965). The graphical representation of *P. noctiluca* matrix model is shown in Fig. 33 and the Projection matrix shown in Fig. 34. A dummy class ( $n_1$ ) was introduced to represent the egg and planula stages but should not be considered the actual population size of either or both stages. It is merely a mathematical construct to distinguish and link between the Mature ( $n_4$ ) and Ephyra ( $n_2$ ) stage. Classes 3-5 in the Malej and Malej (1992) model were combined in our model to a single class ( $n_4$ ).

Fig. 33: Graphical representation of *P. noctiluca* matrix model

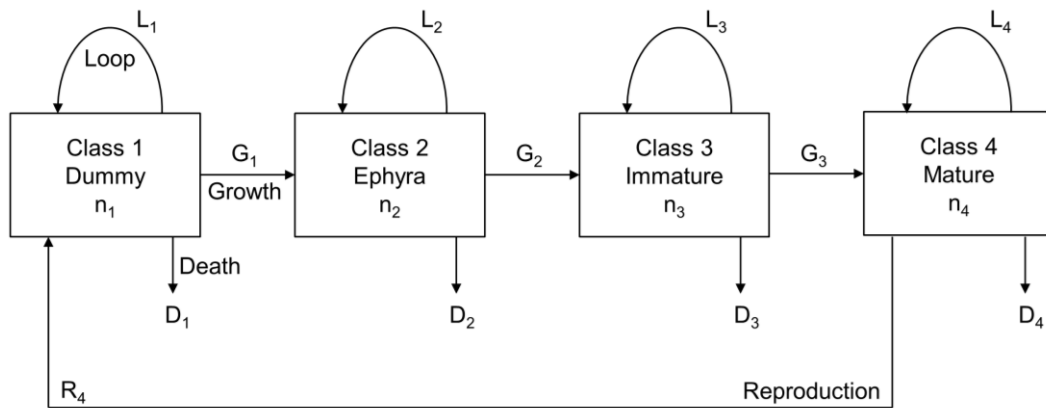


Fig. 34: Projection Matrix of the *P. noctiluca* matrix model

$$M \times n_t = n_{t+1}$$

$$\begin{bmatrix} L_1 & 0 & 0 & R_4 \\ G_1 & L_2 & 0 & 0 \\ 0 & G_2 & L_3 & 0 \\ 0 & 0 & G_3 & L_4 \end{bmatrix} \begin{bmatrix} n_{1t} \\ n_{2t} \\ n_{3t} \\ n_{4t} \end{bmatrix} = \begin{bmatrix} n_{1t+1} \\ n_{2t+1} \\ n_{3t+1} \\ n_{4t+1} \end{bmatrix}$$

Construction of matrix population models requires a large number of parameters to be calculated and in some cases estimated. It is not realistic to expect to have complete knowledge of the population in question over a considerable time span for a specific study zone. The collection of such data would be too costly and variable over time to attain statistical perfection. Caswell (2006) identifies four types of data which can be used to populate a population matrix:

- *Identified individuals*: Data in which individuals are observed and tracked over time.
- *Population time-series*: Data in which a sequence of populations are observed and recorded over time.
- *Stable age or stage distributions*: Data of a single population with the assumption that population structure is stable.
- *Stage durations*: Data on the duration of stages in their life cycle.

Malej and Malej (1992) estimated their parameters using a combination of population time-series and stage durations based on growth and mortality rates and average life expectancy. Although there is some data regarding the population of *P. noctiluca* in the Catalan Sea, the temporal (and spatial) resolution is not sufficient to parameterise a matrix population model. Therefore data was

sought elsewhere in a zone with similar water temperature and oligotrophic conditions. Between January 2008 to January 2011, Rosa et al. (2013) recorded the abundance, size frequency distribution, growth and reproduction of *P. noctiluca* at two study sites in the Straits of Messina (Central Mediterranean). Data was extracted from Rosa et al. (2013) and the parameters estimated using the methodology in Caswell (2006) (See Appendix XII). The parameterised projection matrix is shown in Fig. 35.

Fig. 35: Projection matrix with parameters

$$\text{February – September: } \begin{bmatrix} 0.350 & 0 & 0 & 0 \\ 0.298 & 0.650 & 0 & 0 \\ 0 & 0.003 & 0.201 & 0 \\ 0 & 0 & 0.498 & 0.418 \end{bmatrix}$$

$$\text{October – January: } \begin{bmatrix} 0.350 & 0 & 0 & 2436 \\ 0.298 & 0.650 & 0 & 0 \\ 0 & 0.003 & 0.201 & 0 \\ 0 & 0 & 0.498 & 0.418 \end{bmatrix}$$

In order to estimate the initial population of *P. noctiluca*, data was used from the FISHJELLY research project. During June 2011, samples were taken from around 80 stations along the Catalan coast extending out to the shelf. This data was divided into the zones used in this study, and the average concentration for *P. noctiluca* ephyra and adults was calculated. A summary for the concentration of ephyra and adults for each zone is shown in Table 7:

Table 7: Concentration of *P. noctiluca* for each zone (FISHJELLY data)

	Ephyra 10 m <sup>-2</sup>	Adults 10 m <sup>-2</sup>
Tarragona	237	0.548
Barcelona	488	0.500
Girona	26	1.067

These values are relevant for June but the model starts in January. Therefore the input value for the dummy variable was adjusted until the model produced approximately the same number of adults (mature and immature) in June. The input values for the initial population are shown in Table 8.

Table 8: Expected adults in June and Initial population of “dummy” *P. noctiluca*

	Expected adults in June	Initial "Dummy" population
Tarragona	156 x 10 <sup>6</sup>	1.51 x 10 <sup>11</sup>
Barcelona	187 x 10 <sup>6</sup>	1.86 x 10 <sup>11</sup>
Girona	312 x 10 <sup>6</sup>	3.37 x 10 <sup>11</sup>

The fisheries sub-model requires an input of the total predation  $J$  of jellyfish on each species of fish larvae. The predation rate  $j$  (fish larvae eaten per month by each individual) was determined from the literature and then multiplied by the overall jellyfish population at time  $t$  in each zone. The predation rate is specific to each species of fish  $i$  and for each (life stage) class  $c$  of *P. noctiluca*.

$$J_{i,t} = \sum_{c=2}^4 j_{i,c} \cdot n_{c,t}$$

There is a scarcity of data in the literature regarding the predation rate due to the large amount resources necessary to calculate it. We found no references in the literature regarding the predation of *P. noctiluca* on sardines (larvae or adult) so for our initial analysis  $J$  was set to 0 for sardine.

The predation rate of *P. noctiluca* on anchovy larvae was calculated using data collected along the Catalan coast in June 1995 (Sabatés et al. 2010). A transect perpendicular to the coast near Barcelona with four stations were sampled over a five day period. The stations were located in coastal waters (40 m depth), over the shelf (70-80 m depth), the front (1000 m depth) and in the open sea (>2000 m depth). *P. noctiluca* ephyrae were counted and samples from their gastric pouches identified. The highest concentrations of *P. noctiluca* ephyrae were found at the front, whilst none were found in the coastal water station (Table 9). Although total consumption of fish larvae was greatest at the front, the highest consumption rate was at the shelf. The estimated digestion time of fish larvae in the gastric pouch of *P. noctiluca* is 3 hours (Purcell et al. 2014) so the predation rate per hour is calculated by:

$$\text{Fish larvae eaten per ephyra per hour} = \frac{1}{\text{Digestion time}} \cdot \frac{\text{Total fish larvae eaten}}{\text{Ephyrae examined}}$$

Anchovy larvae are located at around 50 m depth during the day and come to the surface during the night (Olivar et al. 2001, Sabatés et al. 2008). *P. noctiluca* are often found deeper during the day and



only come to the surface at night (Sabatés et al. 2010). Therefore for these calculations we estimated a maximum predation time of 12 hours per day, and the predation of rate of fish larvae per month is shown in Table 9. This is possibly an overestimate according to recent studies and is more likely to be around 8 hours/day (*personal communication V. Fuentes*). Sabatés et al. (2010) also recorded the species of fish larvae consumed at each station - the predation rate on anchovy (“Anchovy larvae eaten per ephyra per month”) is shown in Table 9.

Table 9: Feeding rate of *P. noctiluca* ephyra. Data taken from Sabatés et al. (2010)

	Shelf	Front	Sea
Ephyrae examined	145	4400	1135
Total fish larvae eaten	2	26	5
Fish larvae eaten per ephyra per hour	0.005	0.002	0.001
Fish larvae eaten per ephyra per month	1.655	0.709	0.533
Anchovy (%)	-	38	-
Anchovy larvae eaten per ephyra per month	-	0.269	-

As an initial value for the model, the predation rate (for *P. noctiluca* ephyra on anchovy) was set as 0.269. The predation rate is fixed throughout the year although the total predation will change depending on the population of the jellyfish. This estimation does not take into account the concentration of anchovy larvae compared to other *P. noctiluca* prey. There is no data regarding the predation rate of adult *P. noctiluca* on anchovy, and so was initially set to zero.

One of the objectives of the model is to be able to test hypothetical scenarios in which there are increased blooms for a specific set of years. The cause of these blooms is not clear although many drivers have been proposed including climatic, physical, physicochemical and biological forcings. Canepa et al. (2014) summarise the literature which have proposed various forcings which could explain jellyfish blooms in the Mediterranean. Given the complexity of the issue and the lack of knowledge specific to the study zone, it was decided that these forcings would be outside the model’s boundary. To mimic a bloom the model permits the user to introduce at a given time, for a specific zone, an increase in any of the *P. noctiluca* classes. The increase can either be absolute or multiplicative. Matrix population models can only predict the relative changes in each class for a population, so the initial population is fundamental in determining the final population at the end of the model run. Therefore if there is an artificial increase (or decrease) in the population then this will become the “normal” population until the end of the run. For our model, we only want a

“forced” bloom to last one year and then return to the normal background level. (If the user wants the bloom to be repeated, then it is possible to specify this in the model). Therefore, at the time of a “forced” bloom the model records the currently population of each class. This recorded population replaces the population one year later regardless of what the projection matrix predicts.

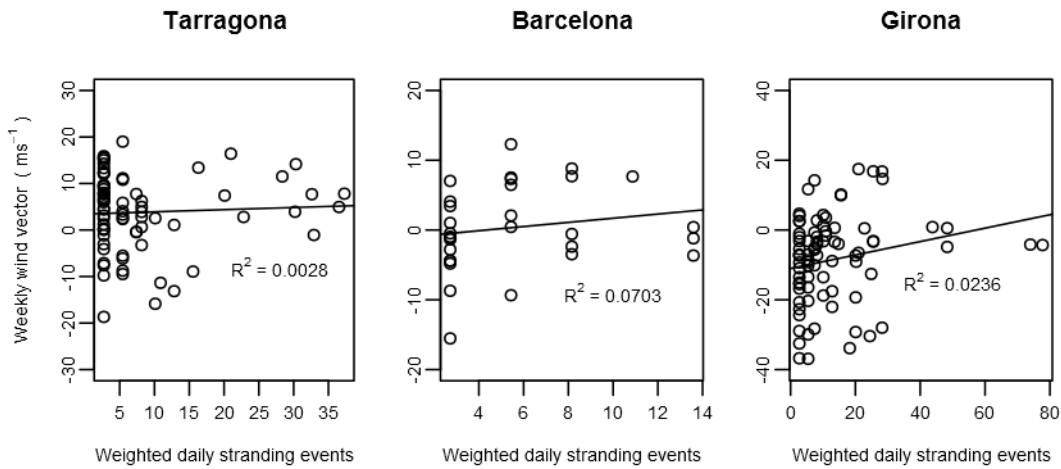
### 3.4.3 Stranding Sub-model

#### 3.4.3.1 Review of stranding models

There exist a number of factors which can influence the arrival of jellyfish to the coast and strand themselves on the beach. Although stranding can occur during the whole year, the highest concentration of *P. noctiluca* occur on Catalan beaches during June and July, decreasing as summer continues. *P. noctiluca* is most abundant around the shelf-slope front (Sabatés et al. 2010). Rubio and Muñoz (1995) predict that blooms occur most frequently under the following condition: Low winter rainfall causes high offshore primary production; a south easterly wind perpendicular to the Catalan coast, push the jellyfish towards the coast during April. High temperature and low rainfall in late spring-summer weaken the front and allow the jellyfish to arrive at the coast. Canepa et al. (2014) analysed the association between jellyfish stranding and prevailing wind direction aggregated weekly for 2007-2010 using Generalised Additive Models. They discovered most stranding events coincided with a wind direction between 100° and 250° (approximately perpendicular towards the coastline), although stranding events also occurred with all wind directions at low wind speeds.

There are no stranding models specifically for *P. noctiluca* although it is probable they will be influenced by the same previously mentioned factors for jellyfish in general. A similar analysis to Canepa et al. (2014) was undertaken for *P. noctiluca* stranding (instead of all jellyfish) in each zone for the data from May to September, 2007-2010. Density weighted daily stranding events (for all beaches in a zone) were plotted against the aggregated weekly wind vector towards the coast for each zone, shown in Fig. 36. A positive wind vector indicates towards the coast, whereas a negative vector is an offshore wind.

Fig. 36: *P. noctiluca* stranding vs weekly wind



Although there was a positive correlation between wind and stranding events in all three zones it was low and very weak. For a linear regression between wind and stranding events,  $R^2$  values range between 0.0028 and 0.0703. In Girona, it appears that there are more stranding events when the wind direction is offshore. Given the poor correlation of the wind-stranding model, it was obvious there must exist other more important factors which influence stranding. Canepa et al. (2014) suggest that the population of jellyfish in the coastal waters are crucial in determining the arrival to the beaches. We therefore decided to investigate a possible correlation between *P. noctiluca* in the coastal waters compared to strandings.

### 3.4.3.2 Stranding model description

Historical data of *P. noctiluca* stranding events (Catalan Water Agency) during the summer months of 2007-2010 along the Catalan coast was analysed and separated into the three zones for our study. A *stranding event* is where a beach within the zone where *P. noctiluca* stranding occurs for one of three degrees of density: “Type 1” has less than ten individuals per beach. “Type 2” has between 10 individuals per beach and less than 1 individual m<sup>-2</sup>, and “Type 3” has greater than 1 individual m<sup>-2</sup> (Canepa et al. 2014). Table 10 shows the average number of each type of stranding event per month per zone. The average Type 1, 2 and 3 stranding proportional to each other are in the ratio 1 : 0.124 : 0.051. So for example, for 100 *Type 1* stranding events, there also would occur approximately twelve *Type 2* and five *Type 3* stranding events. These ratios are used in determining the overall density of each stranding event.

Table 10: *P. noctiluca* summer strandings 2007-2010

			May	June	July	August	September
Tarragona	Type 1	< 10 indiv.	2.75	15	7.25	8.75	2.5
	Type 2	>10, < 1m <sup>-2</sup>	0.75	1.75	0.75	1	0.5
	Type 3	> 1m <sup>-2</sup>	0.5	-	0.5	-	-
Barcelona	Type 1	< 10 indiv.	1.25	6.25	3.75	3.75	0.75
	Type 2	>10, < 1m <sup>-2</sup>	-	-	0.5	-	-
	Type 3	> 1m <sup>-2</sup>	-	-	0.75	-	-
Girona	Type 1	< 10 indiv.	9	23.25	2.25	5.75	5.25
	Type 2	>10, < 1m <sup>-2</sup>	3.25	3.75	0.5	0.5	0.5
	Type 3	> 1m <sup>-2</sup>	1	3.5	-	-	0.25

There is not sufficient sample data to be able to directly compare the quantity of coastal water *P. noctiluca* to stranding events. Therefore the modelled adult *P. noctiluca* population (which was calculated from observed data) was compared against the historical stranding data. This stranding rate ("Type 1" stranding events per coastal water population) is shown in Table 11.

Table 11: Stranding rate of *P. noctiluca* per coastal water population

	Stranding rate (indiv. x 10 <sup>-8</sup> )			
	Tarragona	Barcelona	Girona	Average
May	1.34	0.51	2.20	1.35
June	9.65	3.35	7.48	6.83
July	6.47	2.79	1.00	3.42
August	11.22	4.01	3.69	6.31
September	4.71	1.18	4.95	3.61

The model was run and the stranding events (calculated by the stranding rate per zone) were compared against a separate run which used the same average stranding rate for each zone. The difference between the two models was negligible, so in order to keep the model as simple as possible the average stranding rate was used in the final model.

### 3.4.4 Local economy sub-model

#### 3.4.4.1 Review of local economy models

The model as previously described has a number of outputs for each zone (Tarragona, Barcelona and Girona), or for all zones together (Catalonia). The fisheries sub-model produces the following outputs: Fish population; spawning stock biomass; catches; revenues; losses; and profits. The Jellyfish and stranding sub-models produce the following outputs: *P. noctiluca* population; and stranding events. These outputs could be the final output of the model. However, it would also be beneficial to analyse the impact of changes in *P. noctiluca* population on the local economy (Catalonia), as the tourism sector is much larger than the fisheries sector both in terms of revenues and employment. An *economic impact analysis* (EIA) could determine whether changes in jellyfish blooms would impact more on the tourist sector or the fisheries sector, and how these changes would further influence revenues and employment within the region outside of these sectors.

There are number of ways in which economic impacts can be measured (Weisbrod and Weisbrod 1997):

- Revenues (also referred to as output)
- Value added – increases in local employee wages plus profits. (Also known as gross domestic regional product (GDRP))
- Wealth which includes property and other assets
- Personal income (wages plus other sources of income)
- Employment

Each of these *direct* impacts can then have other effects on the regional economy. *Indirect* effects can occur when the business or sector that is directly affected increases or decreases its trade or services within other sectors. So in the case of an increase in fishing revenues, the fishermen might improve or repair their equipment or employ more workers. Similarly this could change spending patterns of workers in the both the sector in question and those indirectly affected, such as changes in spending on food, clothing and other consumer goods. This is known as an *induced* impact. Finally, these direct impacts can cause long-term changes in the productivity and performance of other sectors, known as *dynamic* or *catalytic* effects (Weisbrod and Weisbrod 1997). Typically EIAs compare the economic activity between two scenarios - one where the event that causes the impact occurs, and one where it does not.

The standard method for undertaking an EIA is using an Input-output model (I/O model). Other more complex econometric and general equilibrium models exist which use the I/O model as a base but also forecast future economic and demographic changes. However, the standard I/O model is published by most developed countries as part of their national accounts, and standards have been set by the United Nations under the System of National Accounts (SNA) (EC et al. 2009).

Wassily Leontief built upon François Quesnay's *tableau economique* (Quesnay 1758) and Léon Walras' general equilibrium theory (Walras 1874), to create a matrix of economic sectors showing the effect each would have on the other sectors. Leontief simplified the calculations by assuming that the inter-trade relations are fixed over the short term (Leontief 1986). Although this made the computations feasible, it should be remembered that any results obtained from an I/O model are approximations and are not valid for medium to long-term forecasts.

Assuming that the regional economy has  $n$  sectors each producing  $x_i$  goods. For sector  $i$  to produce 1 unit of a good, it needs to use  $a_{ij}$  units from sector  $j$ , then the input-output matrix  $\mathbf{A}$  is written:

$$\mathbf{A} = \begin{bmatrix} a_{11} & \cdots & a_{1n} \\ \vdots & \ddots & \vdots \\ a_{n1} & \cdots & a_{nn} \end{bmatrix}$$

Each sector sells some of its output to other sectors. The rest is sold to consumers and is known as final demand  $d$ . So for sector  $i$ , the total output is equal to the sales to all the other sectors plus demand for sector  $d_i$ :

$$x_i = a_{i1}x_1 + a_{i2}x_2 + \dots + a_{in}x_n + d_i$$

This is equivalent to;

$$\mathbf{x} = \mathbf{Ax} + \mathbf{d}$$

and can be solved by rewriting as (where  $\mathbf{I}$  is the identity matrix):

$$\mathbf{x} = (\mathbf{I} - \mathbf{A})^{-1}\mathbf{d}$$

The matrix  $\mathbf{B} = (\mathbf{I} - \mathbf{A})^{-1}$  is known as the Leontief inverse matrix. There are two types of inverse matrices. The type I inverse matrix is as previously described, and measures how much output of each sector is needed to produce one unit of the sector in question. A type II inverse matrix also includes an additional row and column (therefore it will have dimensions  $n + 1$ ) to include compensation and consumption of workers.

Changes in demand  $\mathbf{d}$  is multiplied by the Leontief inverse matrix  $\mathbf{B}$  to calculate the direct, indirect and induced changes required in production of  $\mathbf{x}$ . The coefficients of  $\mathbf{B}$  are called Leontief multipliers.

The *output multiplier*  $O$  is the sum of all outputs of other sectors necessary to produce one unit of output for sector  $j$ :

$$O_j = \sum_{i=1}^n \mathbf{B}_{ij}$$

The *employment multiplier*  $E$  determines the change in employment in all sectors for a given change in output in sector  $j$ :

$$E_j = \sum_{i=1}^n \frac{w_i \mathbf{B}_{ij}}{w_j}$$

where  $w$  is the number of full-time employees per euro in each sector.

In order to construct the input-output matrix, a huge amount of data is needed. Many countries publish input-output matrices many years after the data was initially collected due to the large time resources required. Given that input-output matrices have been used many times to analyse changes in national and regional economies, and the lack of any other well-established competing methodology, it was decided this methodology would form the basis of our local economy sub-model.

#### 3.4.4.2 Description of local economy sub-model

For this study there were not the resources to construct an input-output matrix. However the Catalan Institute of Statistics (IDESCAT) publishes an input-output matrix with Leontief multipliers

every 5-6 years for the whole of Catalonia (IDESCAT 2010). The most recent published input-output model was based on calculations for 2005, detailing 65 sectors (or products), the Leontief inverse matrix and three Leontief multipliers: output; employment (per €1 million); and value added (IDESCAT 2010). The methodological framework used is that recommended by the European System of Accounts (European Commission 2010). The complete input-output matrix, (type I) inverse matrix, and multipliers are available online (IDESCAT 2010) but Table 12 shows the sectors relevant for this study. There is one sector relevant to the fisheries sub-model and three sectors potentially related to the jellyfish stranding sub-model (tourism).

The “Output” Leontief multiplier means that for every €1 change in output (or revenue) for the fisheries sector, there would be €1.35 change in output for the Catalonia. The “Employment” multiplier is the change in employment per million euros. So a €1 million increase in fisheries revenue would increase employment by approximately 19 people in Catalonia. Therefore according to the input-output matrix multipliers, equivalent changes in tourism sectors would have a greater impact than fisheries on GDRP in Catalonia (higher output multipliers) whereas the effect on employment would be lower (lower employment multipliers).

Table 12: Tourism and fisheries multipliers of the input-output model (IDESCAT 2005)

	IDESCAT sector	Output	Employment
Fisheries	Fisheries, Aquaculture and related services	1.35	19.07
Tourism	Hotels, camping and other types of accommodation	1.51	16.54
	Restaurants, beverage establishments, and provision of pre-prepared meals	1.48	13.92
	Travel agencies and tour operators	1.53	9.22

One of the outputs of the fisheries sub-model is revenues so this can easily be applied to the input-output model to calculate regional changes in output and employment. However, the jellyfish stranding sub-model does not calculate the change in demand on any of the tourism related sectors. Of the three tourism sectors in Table 12, if there is an impact caused by jellyfish stranding, it will likely be on hotels and restaurants near the impacted beach as the tourists choose to visit other non-impacted beaches. As part of the VECTORS project, researchers in a separate work task carried out a



stated-choice experiment to ascertain the impact of jellyfish stranding on beach users (Nunes et al. 2015). They used a stated-choice questionnaire and a Random Utility Model to estimate the quantified tourism losses caused by the presence of jellyfish at the beach. During the summer of 2012, 644 questionnaires were completed by beach users in eight Catalan beaches to elicit preferences regarding the following attributes of a given beach: (1) risk of presence of jellyfish, (2) beach water quality, (3) infrastructure and amenities, (4) additional travel time to reach the beach being considered (Nunes et al. 2015).

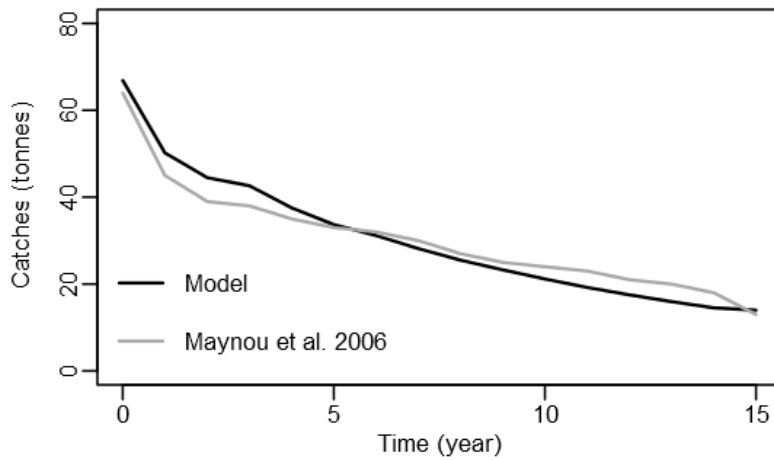
### 3.5 System Appraisal

The System Appraisal step is to verify the output of each of the sub-models as well as the complete model once the sub-models have been connected together. The final step within System Appraisal is to complete the scenario analysis.

#### 3.5.1 Fisheries sub-model

The first step in verifying the fisheries sub-model was to ensure the program ran as intended. Input data was taken from a study using MEFISTO (the model on which our fisheries sub-model was based) analysing the red shrimp (*Aristeus antennatus*) fisheries in the Catalan Sea (Maynou et al. 2006). Our model would not be able to replicate the exact same output as this study because we have not programmed the possibility of dynamic decisions regarding behavioural rules of the fishermen such as changing effort, investing in the capital of the boat and bank loans (In the fisheries sub-model in this study, fishing effort is fixed and there is no reinvestment or possibility of banks loans). Despite these differences between the models, the output is similar as can be seen in Fig. 37 which shows the catches for the model from Maynou et al. (2006), and catches for our fisheries sub-model with the same input parameters.

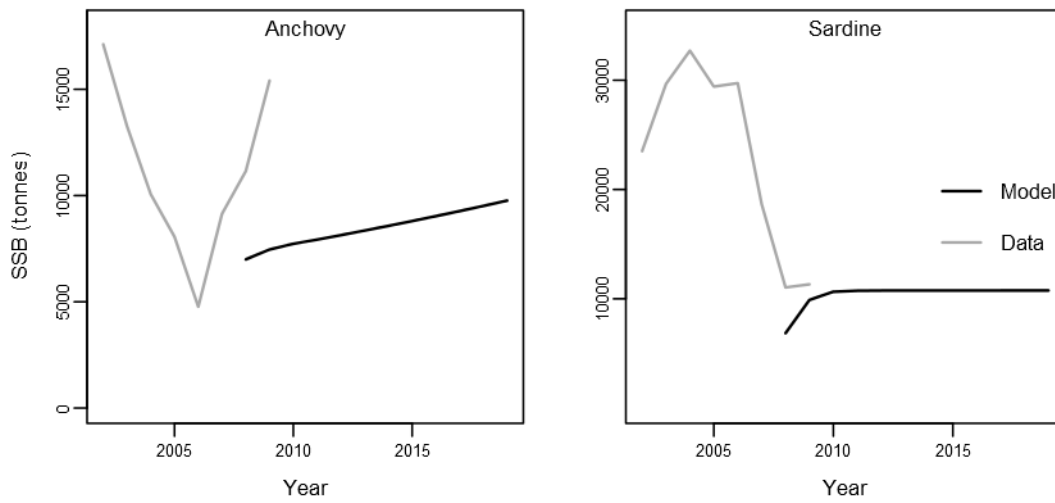
Fig. 37: Catches of red shrimp in Barcelona MEFISTO model (Maynou et al. 2006) and fisheries sub-model



Following this initial verification of the software mechanics of the fisheries sub-model, it was then run with the input data for anchovies and sardines as described in Appendix XI for a 12 year period. This can be seen as analogous for the time period between 2010 until 2020 with an initial two years for the model to stabilise, given that the input data is based on 2002-2009. The model output was then compared against verifiable data. Note that in this section we exclude the predation of jellyfish on sardines and anchovies in order to analysis the functioning of the model against historic data. The impact of different magnitudes of jellyfish blooms is analysed in the scenario analysis (Chapter 3.6.1).

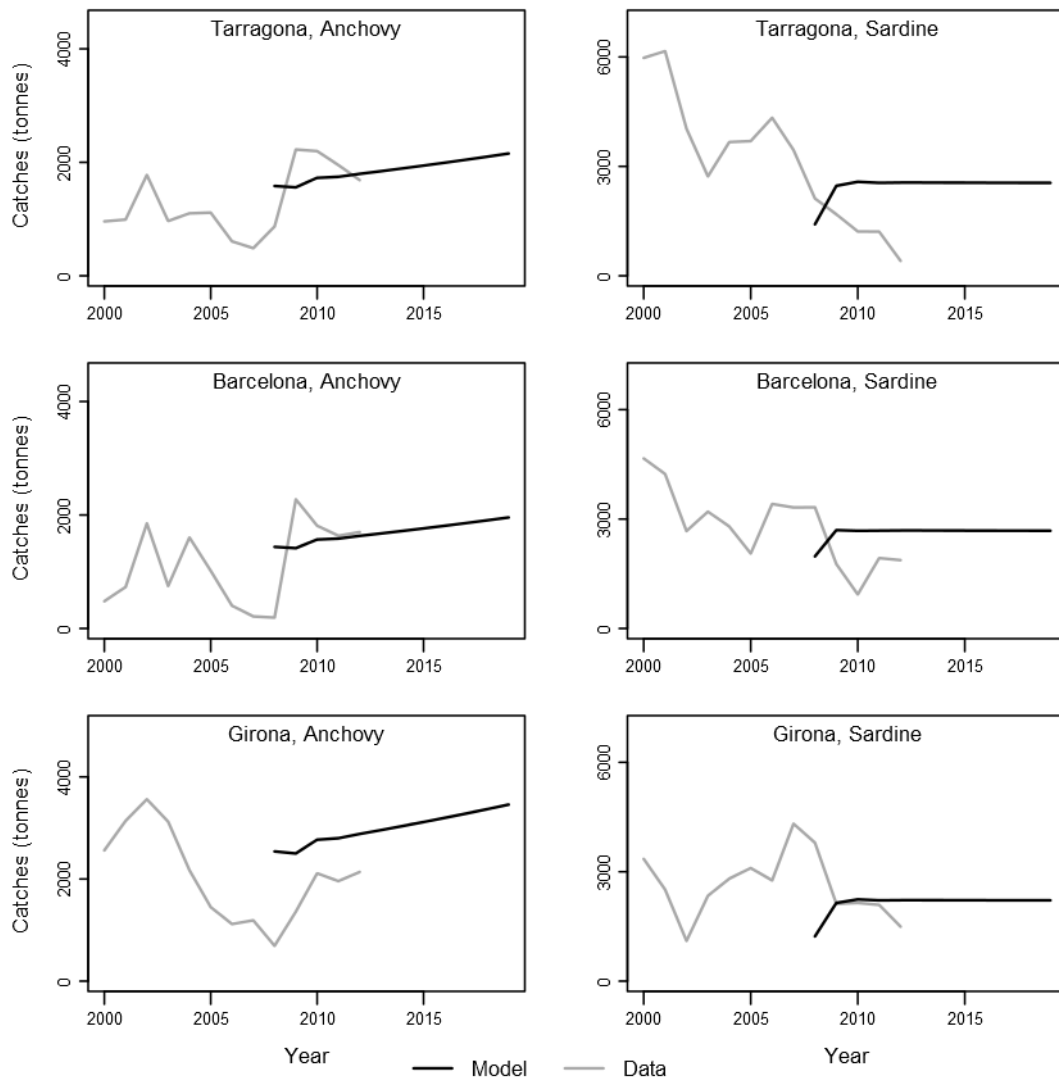
An initial comparison was made between the model output for spawning stock biomass (SSB) and an estimate based on the Western Mediterranean GSA06 zone (Cardinale et al. 2010) for Catalonia. The estimate is used because there is neither SSB data specific for each zone nor for Catalonia. However we have estimated that approximately 58% of GSA06 anchovy landings and 43% of GSA06 sardine landings occur in Catalonia (See Table 29 in Appendix XI for calculations). This approximation was compared against the model output as shown in Fig. 38. The estimated SSB data should be taken with caution as it is not necessarily an accurate measure of the SSB for Catalonia, but the model produces a value for SSB similar to the average over the previous years.

Fig. 38: Sardine and Anchovy SSB for Catalonia – model vs data approximated from GSA06



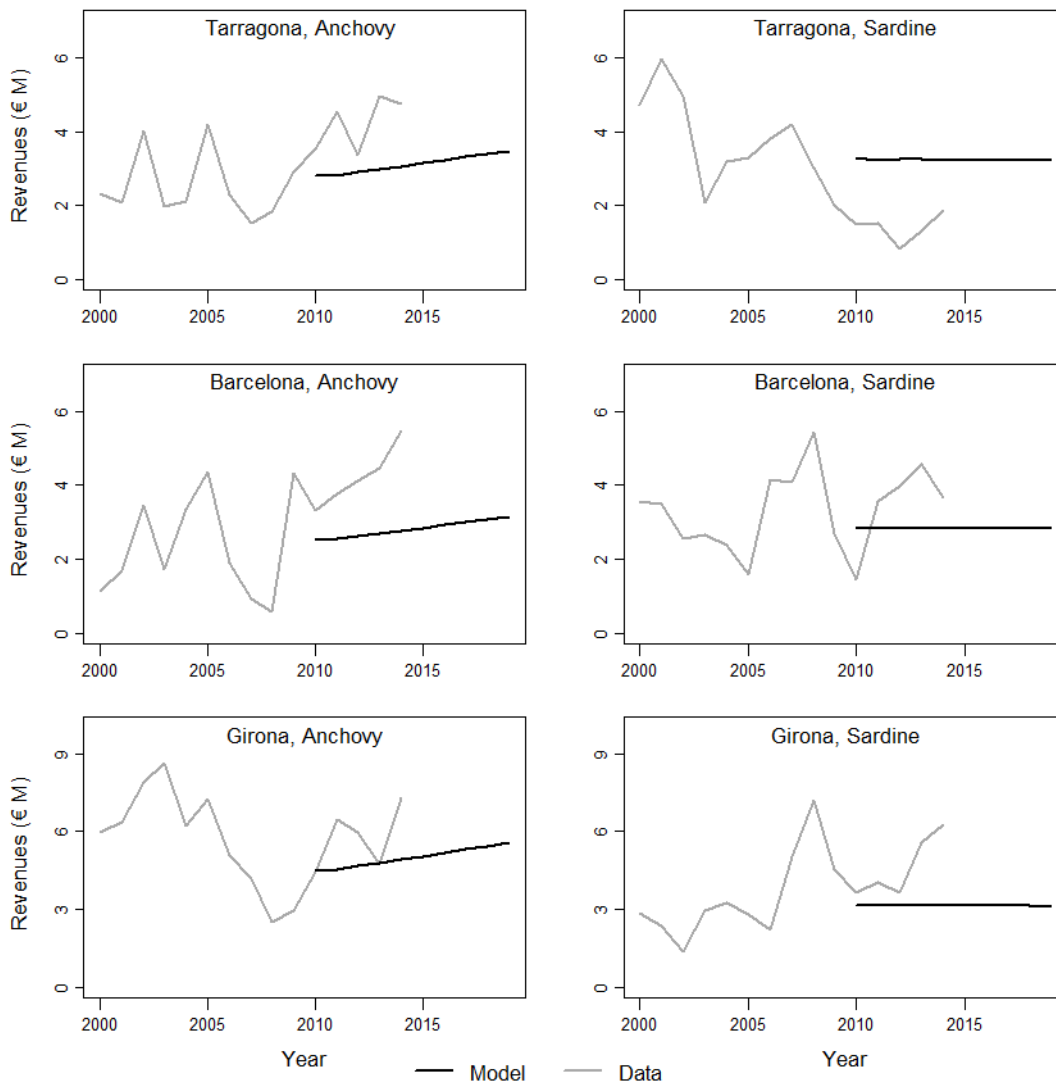
The model output for catches in each zone for anchovies and sardines was then compared with the officially published port data (IDESCAT 2010) (Fig. 39). The model reflects the approximate catches for each zone and species, although it is unable to capture the various year-to-year changes.

Fig. 39: Anchovy and sardine catches – model vs data



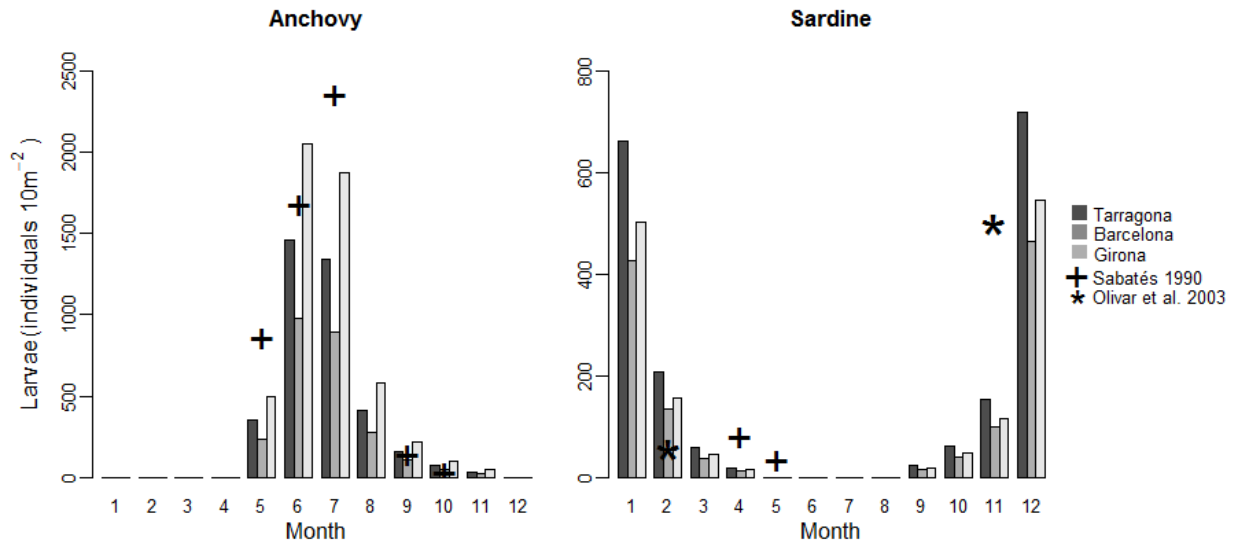
The revenues generated by anchovy and sardine catches are shown in Fig. 40, compared against data gathered from the ports in each zone (IDESCAT 2010).

Fig. 40: Anchovy and sardine revenues – model vs data



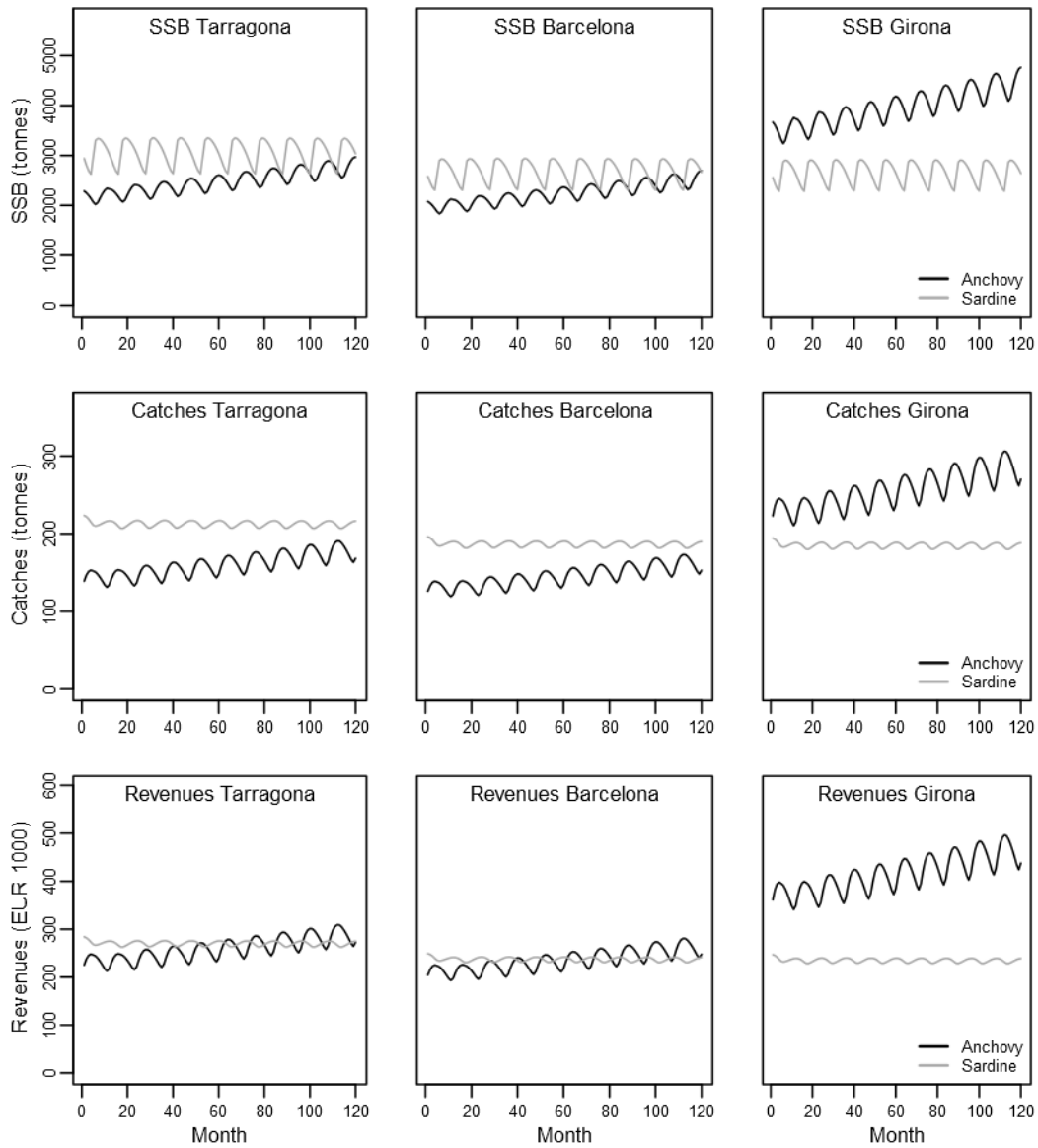
Larvae abundance was then compared against data taken from the literature as shown in Fig. 41. The data from Sabatés (1990) was aggregated over Catalonia whereas the data from Olivar et al. (2003) was taken from an area similar to the Tarragona zone in this study. The larvae abundance for the model is approximately the same each year so only one twelve month period is shown (the first year of simulation, following a two year period allowing for the model to stabilise).

Fig. 41: Anchovy and sardine abundance per 10m<sup>2</sup>. Model vs data taken from Sabatés (1990) and Olivar et al. (2003)



It should be noted that the standard time-step for the model output is in months. The previous outputs have been converted to years to facilitate comparison with recorded data which has been collated in years. When the output is viewed per month, there is an oscillating pattern due to the spawning cycle of anchovies and sardines (Fig. 42).

Fig. 42: Monthly SSB, catches and revenues for anchovy and sardine in each zone



In general, the model produces results similar to observed (and estimated) data. It is unlikely that any model would be able to capture the real variation in catches and fisheries population due to the many complex factors involved. What is important for this model is to be able to approximately capture the average indicators.

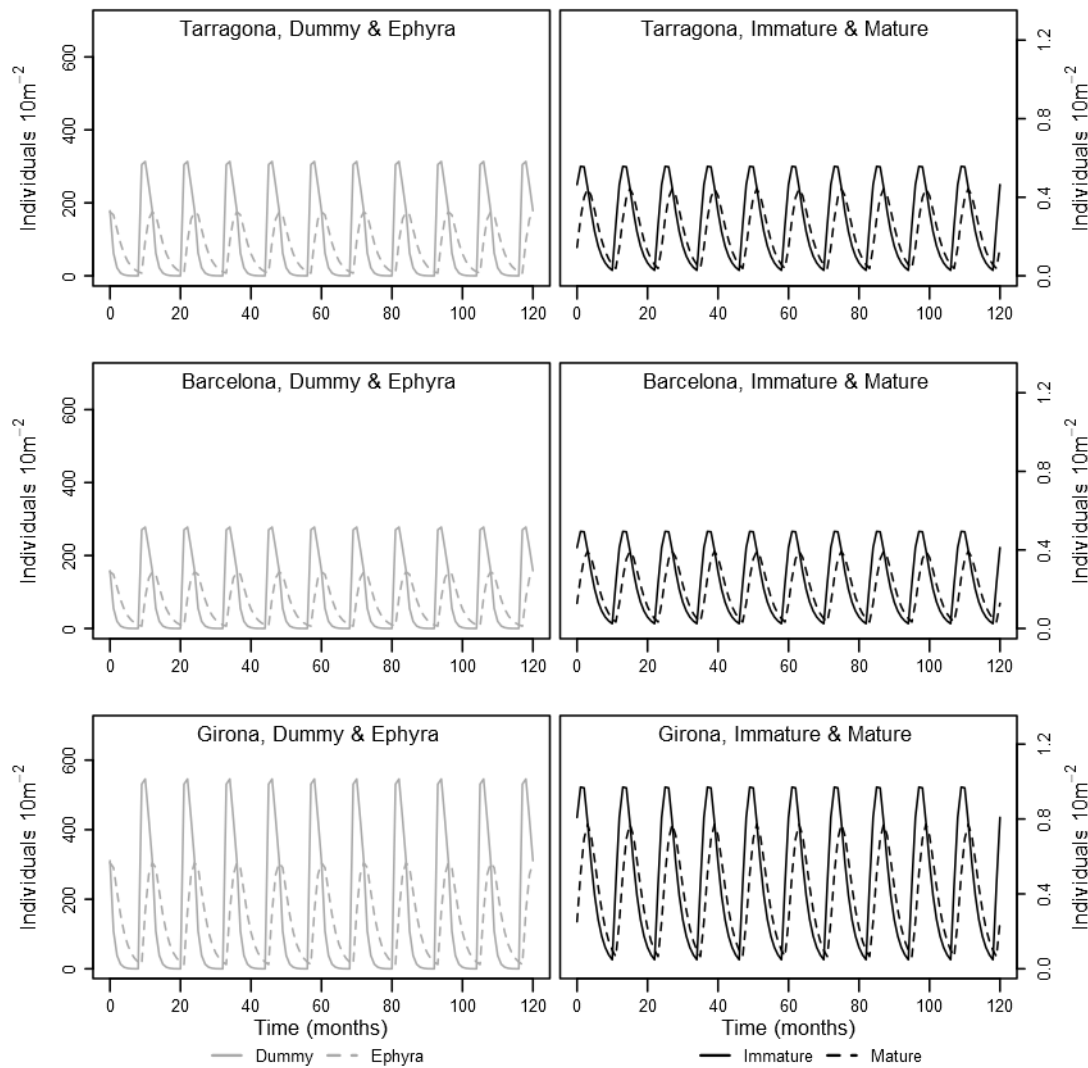
### 3.5.2 Jellyfish sub-model

The ten year output for the jellyfish sub-model using the initial conditions described in Chapter 3.4.2.3 with no forced blooms is shown in Fig. 43. During the calculation of the matrix population model, a noise-free artificial time series was constructed using data from Rosa et al. (2013) as recommended by Caswell (2006) (See Appendix XII for further details). In this constructed time series, over the year there are approximately 55% more immature individuals compared to mature individuals. The projection matrix (calculated from this constructed time series), produces a time series in which there are approximately 35% more immature than mature individuals over a year. This difference is almost certainly an artefact of the way in which this projection matrix was constructed – i.e. by starting with the largest class size and consecutively calculating the lower class sizes. Ideally, the projection matrix should be constructed by using the simultaneous performance of all the parameters (Caswell 2006). However given the lack of observed data at the lower class sizes (dummy and ephyra), greater confidence was placed in the higher classes which had observed data (immature and mature) and thus the projection matrix was constructed starting with the higher classes.

Fig. 44 shows a comparison of the sub-model output for one year against data collected in June 2011 during the FISHJELLY project. “Adult” *P. noctiluca* is the aggregation of immature and mature classes from the matrix population model. The model produces a concentration of adults similar to those observed from the collected samples. In Girona, the model also correctly reflects the number of sampled ephyra, but underestimates it in both Tarragona and Barcelona.

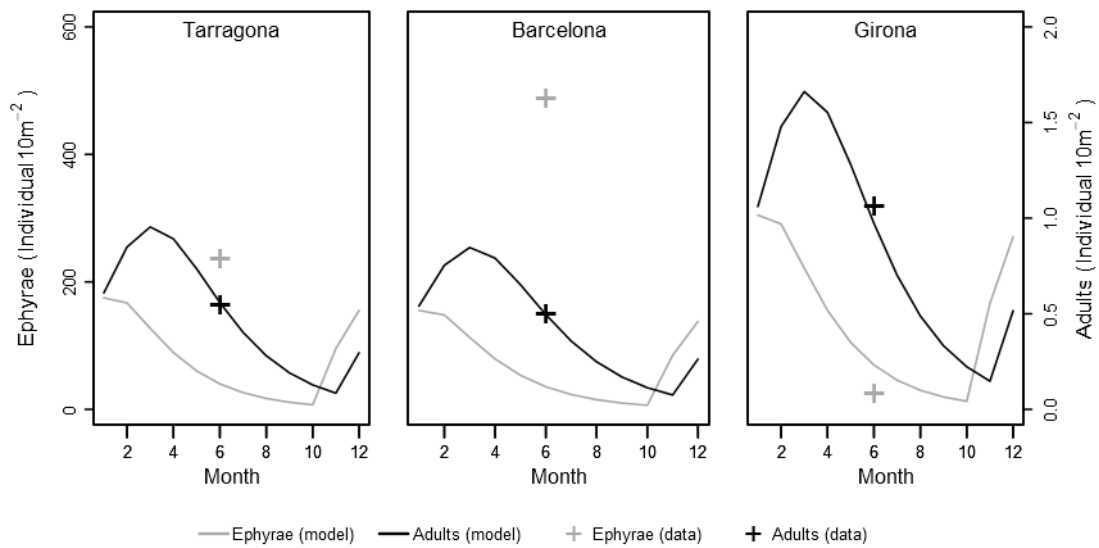


Fig. 43: Concentration of *P. noctiluca* for each class in population matrix model



The ratio of ephyra to adults from the FISHJELLY data are 432:1, 976:1 and 24:1 for Tarragona, Barcelona and Girona respectively. A given population matrix model will always predict the same ratio between classes at a given point in time, so it would be impossible to accurately reflect this data using this type of model unless a population matrix was constructed for each zone. Given that the adult population of *P. noctiluca* is greater in Girona (approximately equivalent to Tarragona and Barcelona combined), and the population of ephyra for the population matrix model was estimated using an average for the whole of Catalonia (see Appendix XII) the model tends to produce the ephyra-adult ratio similar to Girona rather than Barcelona or Tarragona.

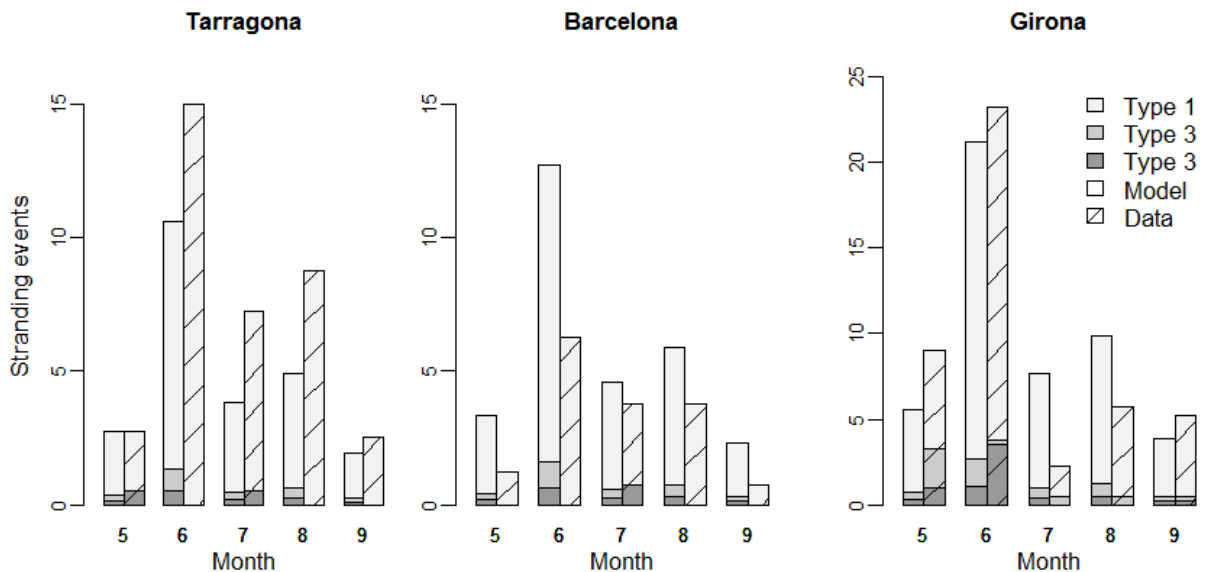
Fig. 44: Comparison of model against data for concentration of *P. noctiluca*



### 3.5.3 Stranding sub-model

The model stranding events for each density type and zone are compared against the observed data (averaged over three years as described in Chapter 3.4.3.2.) in Fig. 45. (Type 1 stranding density has fewer than 10 individuals per beach. Type 2 has greater than 10 individuals per beach and less than 1 individual m<sup>-2</sup>. Type 3 has greater than 1 individual m<sup>-2</sup>). The model underestimates stranding events in Tarragona whereas overestimates in Barcelona. For Girona, the model sometimes underestimates strandings (May, June and September) but overestimates in other months (July and August).

Fig. 45: Summer stranding events for adult *P. noctiluca*



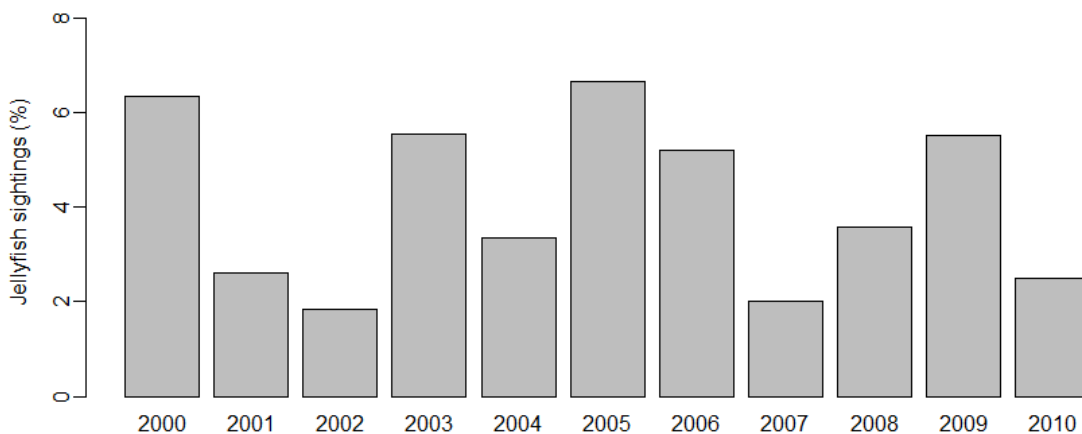
### 3.5.4 Local economy sub-model

The input-output matrix cannot be independently verified because of restricted access to the original data set. However the matrix was built using standard guidelines (European Commission 2010) and qualified professionals (IDESCAT 2005) so there is a high level of confidence in the final result. It should be noted here that the matrix is an accurate reflection of the year in which it was produced, and therefore any predictions using the multipliers are relevant only for the short term (see Chapter 3.4.4).

### 3.6 System Output

Three ten-year scenarios of the complete model were run using varying input levels of *P. noctiluca* blooms. The output of the jellyfish sub-model as described in Chapter 3.5.2 can be considered the background level of *P. noctiluca* which is always present in the coastal waters of Catalonia. Historical data for all jellyfish (not just *P. noctiluca* because the data does not exist during this time) is shown in Fig. 46 for 2000-2010. During this 11 year period, when compared to the years with the fewest sightings, there are approximately five years when the quantity is three times as large, and two years when there are twice as many sightings.

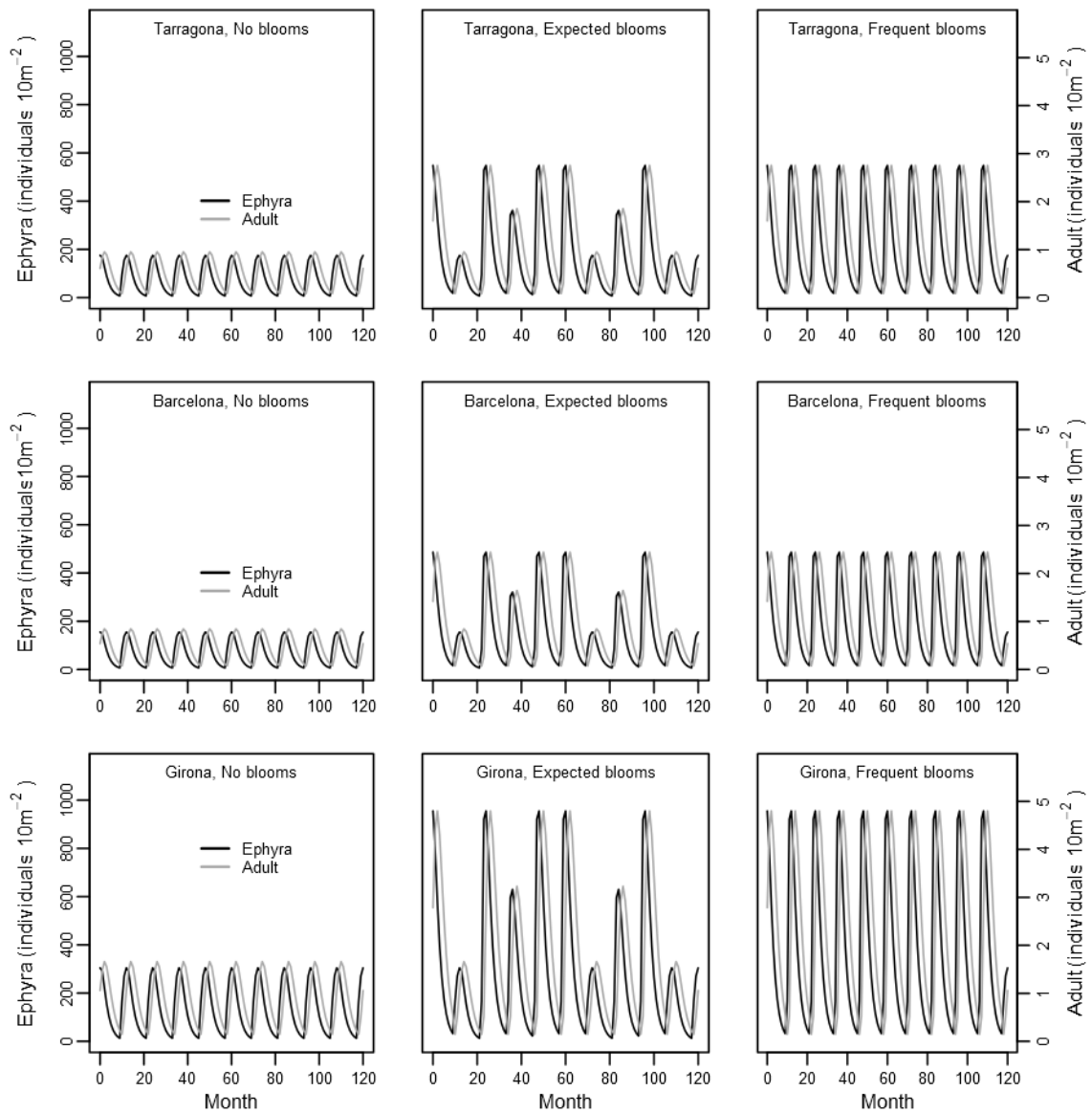
Fig. 46: Jellyfish sightings per beach observation (Catalan Water Agency)



If we assume this is a typical decade (there is not sufficient data to corroborate this), then we can mimic these yearly changes in our input levels for *P. noctiluca* as shown in the “Expected blooms” scenario across all three zones as shown in Fig. 47. Additional scenarios were also tested where only the background levels of *P. noctiluca* are present as shown in the “No blooms” scenario. Finally we can see what would happen if there was a strong bloom (approximately three times as large) every

year for a decade in the “Frequent blooms” scenario. Note that the “immature” and “mature” classes are aggregated to “Adult” in this figure as these are the groups that affect the fisheries and the stranding model respectively, but the model calculates each of the four jellyfish classes separately.

Fig. 47: *P. noctiluca* blooms for each scenario



### 3.6.1 Scenario analysis - fisheries

The effect of changes in *P. noctiluca* blooms for each scenario on the anchovy fisheries is shown in Fig. 48. An increase in *P. noctiluca* blooms causes a reduction in SSB and thus catches and revenues in each of the study zones. The expected annual anchovy catches and revenues in each zone is shown in Table 13, and the change in anchovy catches and revenues of *No blooms* and *Frequent blooms* compared to *Expected blooms* is shown in Table 14. (The change in percent is the same for catches and revenues because the price of anchovy is fixed during the forecast period). Over the average ten year forecast period, there would be an estimated 5.1% increase in anchovy catches per year when comparing the *No blooms* scenario to *Expected blooms*. On the other hand, under the *Frequent blooms* scenario there would be a loss of anchovy catches by 2.6% per year when compared to *Expected blooms*. Girona is the most affected by the change in scenario of the three zones in absolute terms due to the larger size of its anchovy fisheries. However, Barcelona is relatively more impacted by changes in blooms although the difference is similar between zones. It is also noted that the reduction or increase in catches is greatest towards the end of the simulation, implying that the changes would continue to reduce (in the *No blooms* scenario) or increase (in the *Frequent blooms* scenario) when compared to the *Expected blooms*.

Table 13: Expected annual anchovy catches and revenues for each scenario

Catches (T)	No blooms	Expected	Frequent
Tarragona	1747	1676	1640
Barcelona	1545	1462	1420
Girona	2742	2603	2533
Catalonia (Total)	6034	5740	5593
Revenues (€M)	No blooms	Expected	Frequent
Tarragona	2.85	2.74	2.68
Barcelona	2.52	2.39	2.32
Girona	4.48	4.25	4.14
Catalonia (Total)	9.85	9.38	9.14

Fig. 48: Impact of changes in *P. noctiluca* blooms on anchovy SSB, catches and revenues

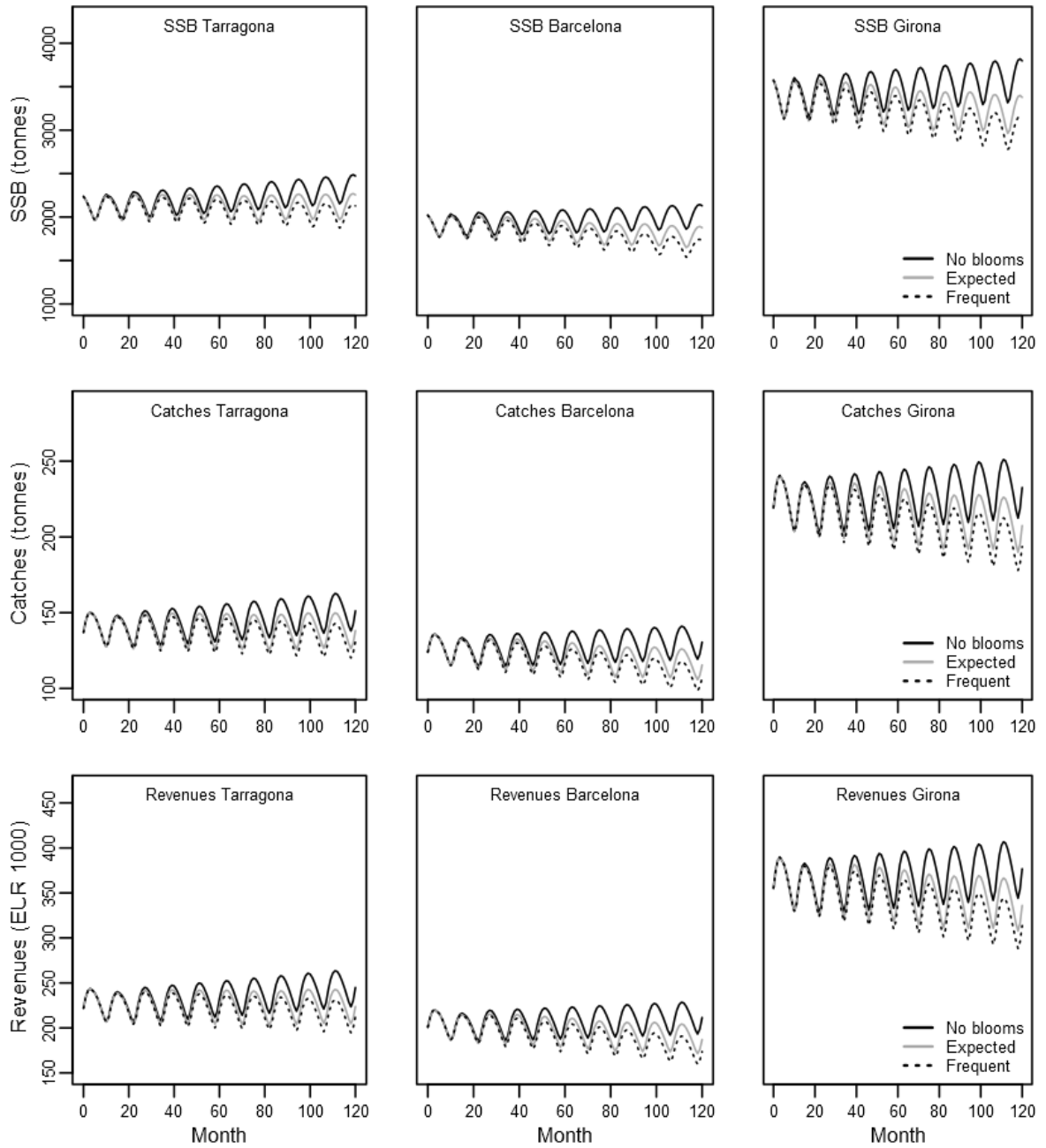
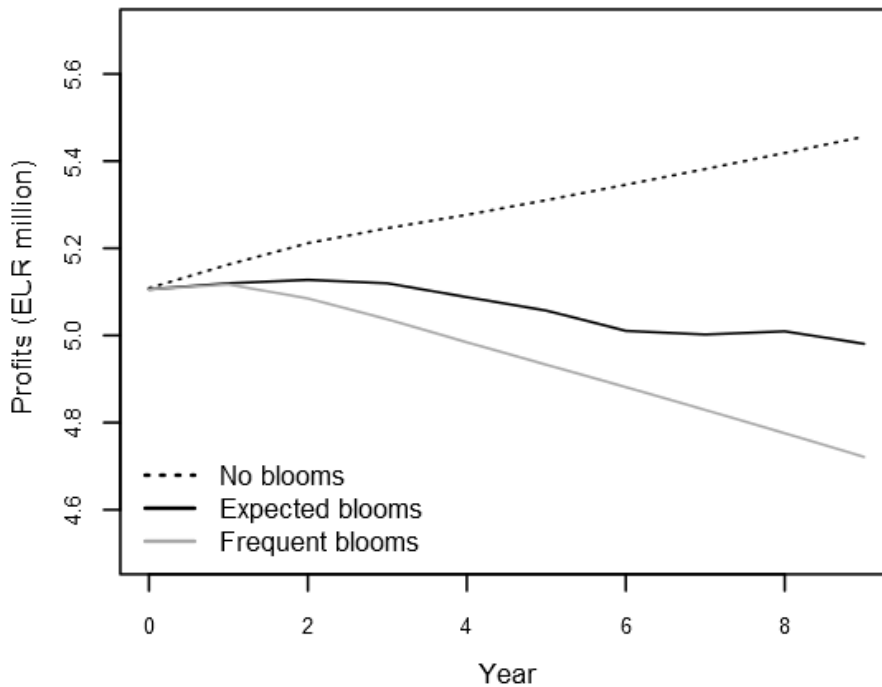


Table 14: Percent change in annual anchovy catches and revenues relative to *Expected blooms*

	No blooms		Frequent blooms	
	Yearly average	Last year	Yearly average	Last year
Tarragona	4.2	8.8	-2.1	-4.8
Barcelona	5.7	12.2	-2.9	-6.7
Girona	5.3	11.3	-2.7	-6.2
Catalonia (Total)	5.1	10.8	-2.6	-5.6

Given that in this scenario analysis there is no predation of *P. noctiluca* on sardines (as there is lacking evidence of predation by *P. noctiluca* on sardines), the SSB, catches and revenues are the same as in Fig. 42 (in Chapter 3.5.1). The change in profits for both sardine and anchovy fisheries under the various scenarios for the whole of Catalonia is shown in Fig. 49. In comparison to the *Expected blooms* scenario, there would be an increase in profits of around 4.5% per year under the *No blooms* scenario. There would be a loss in profits of around 2.3% per year in the *Frequent blooms* scenario.

Fig. 49: Yearly profits of anchovy and sardines fisheries for Catalonia in each of the three scenarios



### 3.6.2 Scenario analysis – stranding events

The average number of *P. noctiluca* stranding events per month over a ten-year forecast period for each scenario is shown in Table 15. Stranding events occur most frequently in both quantity and density during the *Frequent blooms* scenario - there is an increase of 33% in stranding events compared to the *Expected blooms* scenario for Catalonia. When compared to the *Expected blooms* scenario, there would be a 49% decrease in stranding events in Catalonia when compared to the *No blooms* scenario. Girona is the most affected zone, and in all zones June is the month with highest number of stranding events. Yearly stranding events for each scenario is shown in Table 16.

Table 15: Average *P. noctiluca* stranding events per month

Type 1 (<10 beach <sup>-1</sup> )		May	June	July	August	September	Total
No blooms	Tarragona	2.8	10.7	3.9	5.0	1.9	24.2
	Barcelona	3.3	12.8	4.6	6.0	2.3	29.1
	Girona	5.6	21.4	7.7	9.9	3.9	48.4
	Catalonia	11.7	44.9	16.2	20.8	8.1	101.7
Expected	Tarragona	5.6	21.0	7.5	9.5	3.7	47.3
	Barcelona	6.7	25.2	9.0	11.4	4.4	56.7
	Girona	11.1	42.0	15.0	19.1	7.4	94.6
	Catalonia	23.4	88.2	31.4	40.1	15.5	198.6
Frequent	Tarragona	7.4	27.9	9.9	12.6	4.9	62.7
	Barcelona	8.9	33.5	11.9	15.1	5.8	75.2
	Girona	14.8	55.8	19.8	25.2	9.7	125.4
	Catalonia	31.2	117.2	41.6	52.9	20.5	263.3
Type 2 (<1 m <sup>-2</sup> )		May	June	July	August	September	Total
No blooms	Tarragona	0.3	1.3	0.5	0.6	0.2	3.0
	Barcelona	0.4	1.6	0.6	0.7	0.3	3.6
	Girona	0.7	2.7	1.0	1.2	0.5	6.0
	Catalonia	1.4	5.6	2.0	2.6	1.0	12.6
Expected	Tarragona	0.7	2.6	0.9	1.2	0.5	5.9
	Barcelona	0.8	3.1	1.1	1.4	0.5	7.0
	Girona	1.4	5.2	1.9	2.4	0.9	11.7
	Catalonia	2.9	10.9	3.9	5.0	1.9	24.6
Frequent	Tarragona	0.9	3.5	1.2	1.6	0.6	7.8
	Barcelona	1.1	4.2	1.5	1.9	0.7	9.3
	Girona	1.8	6.9	2.5	3.1	1.2	15.5
	Catalonia	3.9	14.5	5.2	6.6	2.5	32.7
Type 3 (>1 m <sup>-2</sup> )		May	June	July	August	September	Total
No blooms	Tarragona	0.1	0.5	0.2	0.3	0.1	1.2
	Barcelona	0.2	0.7	0.2	0.3	0.1	1.5
	Girona	0.3	1.1	0.4	0.5	0.2	2.5
	Catalonia	0.6	2.3	0.8	1.1	0.4	5.2
Expected	Tarragona	0.3	1.1	0.4	0.5	0.2	2.4
	Barcelona	0.3	1.3	0.5	0.6	0.2	2.9
	Girona	0.6	2.1	0.8	1.0	0.4	4.8
	Catalonia	1.2	4.5	1.6	2.0	0.8	10.1
Frequent	Tarragona	0.4	1.4	0.5	0.6	0.2	3.2
	Barcelona	0.5	1.7	0.6	0.8	0.3	3.8
	Girona	0.8	2.8	1.0	1.3	0.5	6.4
	Catalonia	1.6	6.0	2.1	2.7	1.0	13.4



Table 16: Average *P. noctiluca* stranding events per year

Zone	No blooms			Expected blooms			Frequent blooms		
	Type 1 < 10 per beach	Type 2 < 1 m <sup>-2</sup>	Type 3 > 1 m <sup>-2</sup>	Type 1 < 10 per beach	Type 2 < 1 m <sup>-2</sup>	Type 3 > 1 m <sup>-2</sup>	Type 1 < 10 per beach	Type 2 < 1 m <sup>-2</sup>	Type 3 > 1 m <sup>-2</sup>
Tarragona	24	3	1	47	6	2	63	8	3
Barcelona	29	4	1	57	7	3	75	9	4
Girona	48	6	2	95	12	5	125	16	6
Catalonia	102	13	5	199	25	10	263	33	13

### 3.6.3 Scenario analysis – local economy

In order to analyse the effect of each scenario on the local economy, the changes in output of the fisheries and jellyfish sub-model need to be known. The fisheries sub-model produces changes in revenues but the jellyfish sub-model only records the changes in stranding events. Using the analysis undertaken in VECTORS in the same study zone, Nunes et al. (2015) calculated the consumptive value of travel time using a random parameters model as approximately 25 minutes. Respondents were found to be willing to travel an additional 3.81 minutes more per trip to go to a beach with a jellyfish presence of less than two days a week rather than one with more than five days a week (the 95% confidence interval is between 2.066 and 5.553 minutes). Taking into account only the subsample of those that made a trade-off between various beach attributes (approximately 50% of respondents), and given the average household income per hour was €19.23 for 2012, individuals are willing to pay on average €3.20 to visit a beach with lower risk of jellyfish presence (Nunes et al. 2015). (Nunes et al. (2015) do not distinguish between species of jellyfish on beach user preferences).

The maximum number of (*Type 1*) stranding events per month is 55.8 in Girona in June for the *Frequent blooms* scenario. There are 71 beaches in Girona, which is equivalent to approximately 0.2 *Type 1* stranding events for each beach per week, far fewer than the threshold elicited by Nunes et al. (2015). Therefore according to their analysis and the stranding model results, the impact of *P. noctiluca* on beach users under all scenarios is zero given that Nunes et al. (2015) do not reveal anything about beach user preferences when jellyfish stranding events are less than two per week.

The impact on the regional economy under the three scenarios using the economic input-output matrix is shown in Table 17. The table shows the annual fisheries revenues (anchovy and sardine) for each scenario averaged over the ten year forecast period. The change in annual revenue is the difference between *Expected blooms* when compared to *No blooms* and *Frequent blooms* respectively. Note that this difference is created uniquely by changes in revenues to the anchovy

fisheries, because the predation rate of *P. noctiluca* on sardines is unknown and therefore set to zero (Chapter 3.4.2.3). Stranding events are not included in this table as the threshold is not reached in which they have a measurable effect on the beach users. The impact the change in revenue has on the regional economy, measured using the input-output matrix is low for each scenario - less than 0.001% of the regional gross regional product (GDRP) in both cases. Similarly the impact on the regional employment is low in both cases. The change in employment would not necessarily only occur in the fishing sector but even if it did, the changes would account for less than 0.3% of employment in the fishing sector in each scenario.

Table 17: Effect of *No blooms* and *Frequent blooms* scenarios on local economy, compared to *Expected blooms*

Scenario	Average yearly revenue (2010-2020) (€)	Change in revenue* (€)	Change in regional economy* (€)	Change in regional employment* (individuals)
Expected blooms	20,674,929	-	-	-
No blooms	21,150,777	475,848 (102%*)	641,444 (<0.001% of reg. GDRP)	12 (0.3% fishing sector)
Frequent blooms	20,436,377	-238,552 (99%*)	-321,568 (<0.001% of reg. GDRP)	-6 (-0.1% fishing sector)

2010 GDRP of regional economy €143,000 million.  
2010 Employment in fishing sector is 4183

\*compared to "Expected blooms"

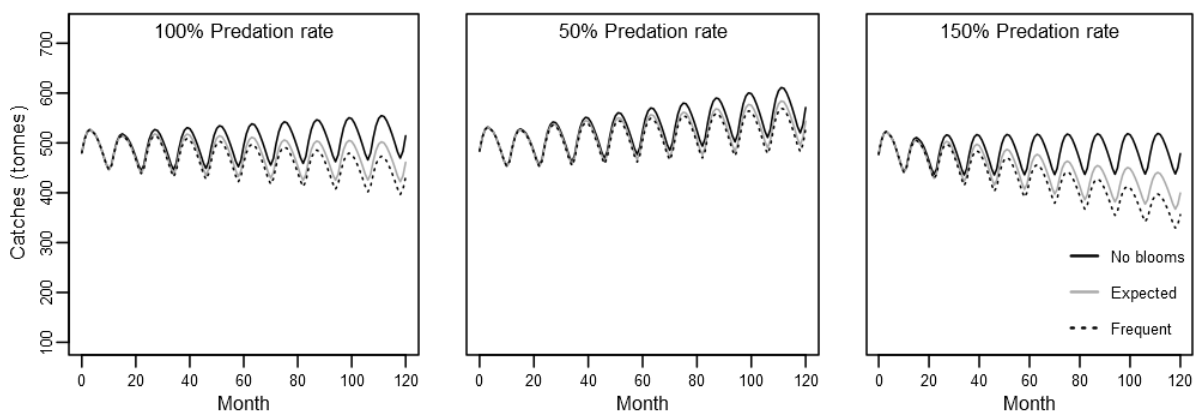
#### 3.6.4 Sensitivity analysis of key variables

There are many uncertain variables in the model which could have a significant impact on the various scenarios presented here. Even the scenarios themselves are a reflection of the uncertainty in the future number of *P. noctiluca* blooms. The following key variables, which have been estimated to the best of our knowledge given the availability of data, could strongly influence the various scenarios previously presented:

- Predation rate of *P. noctiluca* ephyra on anchovy larva
- Predation rate of *P. noctiluca* ephyra on sardine larva (currently set to zero for lack of data)
- Beach stranding rate of *P. noctiluca*

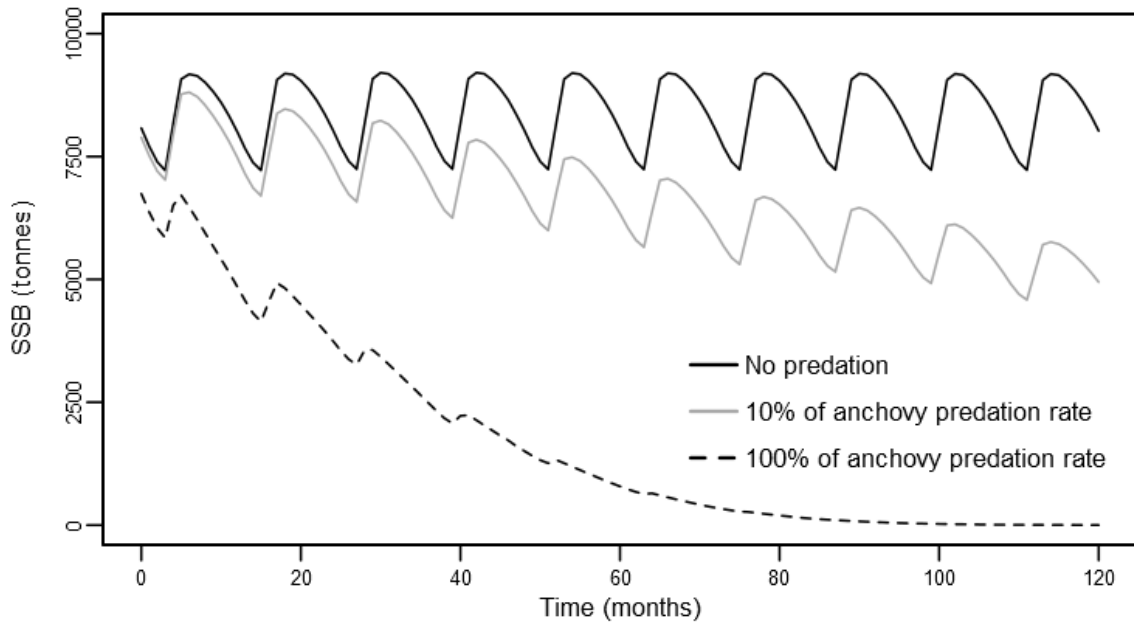
An increase and decrease of 50% in the predation rate of *P. noctiluca* ephyra on anchovy larva is shown in Fig. 50. Increasing the predation rate amplifies the difference in catches for changes in *P. noctiluca* blooms, and conversely decreasing the predation rate reduces the difference in catches for each scenario. Using 100% predation rate (as we did in the previous scenario analysis) we calculated that anchovy revenues would increase by 5.1% for *No blooms* and decrease by 2.5% for *Frequent blooms* when each are compared to *Expected blooms*. If the predation rate is increased to 150% of the original rate then anchovy revenues would increase by 8.1% for *No blooms* and decrease by 4.5% for *Frequent blooms* when compared to *Expected blooms*. Conversely if the predation rate is decreased by 50%, then anchovy revenues would increase by 2.4% for *No blooms* and decrease by 1.2% for *Frequent blooms* when compared to *Expected blooms*.

Fig. 50: Sensitivity of predation rate of *P. noctiluca* ephyra on anchovy larva



We could not find any data regarding the predation rate of *P. noctiluca* ephyra on sardine larva, therefore we set the value to zero during the previous scenario analysis. However, we can analyse the effects on sardine population using an estimate of the value based on the predation rate of *P. noctiluca* ephyra on anchovy larva (Fig. 51). Using the same predation rate (100% of anchovy predation rate) as that on anchovy (and the *Expected blooms* scenario) decimates the sardine population within the decade so clearly the rate must be much lower. Even applying a predation rate of 10% of that on anchovy has a significant effect on the sardine population, reducing the SSB by about a third over ten years. Clearly, the predation rate of *P. noctiluca* ephyra on sardine larva must be lower than 10% of that of the predation rate on anchovy.

Fig. 51: Effect of *P. noctiluca* predation rate on sardine SSB



The beach stranding rate is an uncertain variable within the model. In fact the actual model structure is a massive simplification of all variables which could influence the stranding of jellyfish as outlined in Chapter 3.4.3.2. The stranding model works such that there is a direct relation between the stranding rate and the number of stranding events, so doubling the stranding rate would double the number of stranding events. Given that the model is certainly a simplification of the actual processes which influence stranding events, there is not much benefit in further analysing the effects of changes in stranding rate.

### 3.7 Discussion

There are two sets of conclusions that can be made from this application of the Systems Approach Framework. Firstly, there are conclusions that can be made from the modelling component of the application, and secondly there are conclusions related to the application as a whole – whether it met the objectives of the SAF, and what was learned during the process.

### 3.7.1 Discussion of the model

In order to analyse the impact of changes in *P. noctiluca* blooms on fisheries, beach tourism and the regional economy in Catalonia using the model created here, we must first acknowledge the limitations in availability of data and knowledge and the drawbacks of the modelling methodology.

The model is unable to predict the independent effects on fisheries in the absence or presence of *P. noctiluca*. If there were a large increase in predation on the small pelagics which significantly reduced the population, it is likely that the predation rate would decrease as the *P. noctiluca* would change to prey on other more abundant planktonic communities. Similarly, an increase in small pelagics larva would probably cause an increase in predation rate. However, the model does not try to capture these dynamics due to a lack of data. These dynamic effects would probably only be significant when there are large changes to population level of the small pelagics so will not significantly change the results of the described scenarios.

The population and migration of *P. noctiluca* depend on many physical, physicochemical, biological and climatic forcings (Canepa et al. 2014) which have been omitted from the model due to lack of data and knowledge. Therefore simplifications and estimations have been used in the model as described in System Formulation (Chapter 3.4.2.3). Once these data gaps have been completed, the model can be adapted to incorporate a more accurate estimate of *P. noctiluca* population levels within the Catalan Sea. The initial population of *P. noctiluca* was estimated from one data set in June 2011. Given that the sampled population could vary considerably, it is difficult to ascertain an accurate estimate for a given time and zone. The various bloom scenarios try to capture some of this uncertainty, but a more accurate data set of changes in population levels would benefit the model and improve the reliability of the model output. For example, in each scenario the changes in blooms occur proportionally the same in each zone. It is likely that blooms occur more frequently and with greater magnitude in certain zones. The model is capable of reproducing such an input, but until further data is available there is little to be gained from running these hypothetical scenarios, especially as there would be a huge number of possibilities. Similarly the model is also capable of permitting migration between zones (as well as increasing the number of zones) and when the data becomes available, can be used accordingly.

As described in System Appraisal – jellyfish sub-model (Chapter 3.5.2), the ratio of *P. noctiluca* ephyra to adults in June 2011 varies considerably in each zone. This value is needed in order to estimate the population of ephyra during the whole year. Given this variation, the model could be

improved if a population matrix was constructed separately for each zone rather than aggregated across all of Catalonia.

The predation rate of *P. noctiluca* on anchovy was taken from just one research cruise off the coast of Barcelona in June 1995 in which only ingestion by ephyra and not adults were analysed (Sabatés et al. 2010). While this is probably accurate for the time and location, it is likely that this predation rate varies both temporally and spatially, and depends on the availability of other prey. Previous studies suggest that *P. noctiluca* is an opportunistic non-selective predator, feeding on what is in the near vicinity and does not actively target specific species (Malej 1989). The model aggregates large areas which limits the ability to predict the outcome when dense population of predators coincide temporally and spatially with a dense population of prey. Smaller zones could possibly alleviate this problem but that would require a much larger set of input data to calculate the predation rate across all zones and during the whole year. Other studies have suggested that the effect of predation of *P. noctiluca* on fish populations could be greater than those revealed in this study (Purcell et al. 2014). There is a lack of data regarding the predation rate on sardine although the sensitivity analysis reveals that it would likely be much smaller than that on anchovy. This could be due to the higher availability of other planktonic prey such as copepods (Fernández de Puelles et al. 2007) or that *P. noctiluca* and sardine larva do not coincide spatially. However, even though the predation rate might be lower, the overall effect on the sardine population could still be significant.

The standing model does not account for all the complex factors involved in predicting the arrival of jellyfish to the beaches as acknowledged in Chapter 3.4.3.2. When a more accurate stranding model has been developed it could be incorporated into this model, improving its predictive capacity and output related to the effect on beach users. In the study which analysed the impact of stranding events on beach users (Nunes et al. 2015), the only alternative is to travel to another nearby beach without jellyfish, calculating the extra cost involved. Although the costs to the restaurants and hotels near to an impacted beach could be significant, the overall change to the local economy would be much lower (possibly zero) as other businesses near to unaffected beaches would benefit. A currently unexplored analysis would be to try to calculate the impact if jellyfish stranding events increased to a level where beach users would consider visiting beaches regions outside of Catalonia or even outside of Spain. This would have a significantly higher impact on the Catalan economy.

Bearing in mind these caveats to the model, the results of the scenario analysis show that *P. noctiluca* has a low impact on small pelagic fisheries, beach users and the regional economy. The

significance of the impact on the anchovy fisheries should be viewed in the context of historical fluctuations in anchovy catches. The standard deviation of year-to-year anchovy catches in Catalonia over the last five years is 1329 tonnes. This is considerably greater than the standard deviation of the most contrasting scenarios (*No blooms* compared to *Frequent blooms*) which is 311 tonnes. Therefore there are other factors involved which have a much greater impact on anchovy fisheries than predation of *P. noctiluca* on anchovy larva.

As previously described the effect of *P. noctiluca* stranding events on beach users is zero within our analysis given the findings of Nunes et al. (2015). This is possibly due to the aggregated spatial dimension of the model which cannot determine when there many stranding events in one beach (for a given zone) or the stranding events are spread across many beaches in one zone. It is probable that certain beaches within a zone are more susceptible to stranding events. In this case the stranding events could surpass the threshold which influences the beach user's decision to visit another beach with fewer jellyfish. Increasing the number of stranding zones in the model could reduce this problem, although higher resolution data and stranding sub-model would be necessary. It should also be remembered that Nunes et al. (2015) do not distinguish between different jellyfish species in their analysis, and it is possible that the combined effect of *P. noctiluca* stranding with other species will also reach the threshold in which beach users choose to visit a different beach.

So given that the impact of *P. noctiluca* on both beach users and sardine fisheries is zero, it is unsurprising that the corresponding impact on the regional economy is low. However, the tourist industry has a greater potential to impact the regional economy than the fisheries industry. This is because the tourist industry is much larger than the fisheries industry and because its effect on economically dependent industries is larger, as demonstrated by the higher output multiplier value from the input-output matrix. However this study only analyses the effect of *P. noctiluca* on fisheries and beach users. There are over 12 species of scyphomedusae in the region (Canepa et al. 2014) and the combined effect of *P. noctiluca* with these species would likely have a greater impact on small pelagic fisheries and beach users than the results from this analysis. This analysis should be viewed as a first attempt at analysing the complex effect of jellyfish on fisheries and beach tourism, and would be greatly improved by including further jellyfish species once the relevant data is available.

There are few studies which try to quantify the impact of jellyfish on social ecosystems and those that do, tend to be limited to just one economic sector. Nunes et al. (2015) show that 50% of beach users are willing to pay an additional €3.20 per trip in order to visit beaches with fewer jellyfish.

So for an estimated 263 million beach visits per year aggregated wellbeing gains associated with a reduction of jellyfish blooms would be around €423 million per year for the whole of the Catalonia or 11.95% of tourism expenditures in 2012. Ghermandi et al. (2015) estimate that there could be annual monetary losses of €1.8-6.2 million due to 3-10.5% fewer seaside visits caused by jellyfish outbreaks in Israel. Kontogianni and Emmanouilides (2014) estimate that households in the Gulf of Lions are willing to pay a one-off single payment of €66 (on average) in order to reduce expected jellyfish outbreaks from 9 years per decade to 1 year per decade. In a survey completed by fishermen in Oregon regarding the perceived impact of jellyfish on their activities in 2012 (Conley and Sutherland 2015), the estimated economic impact on salmon and pink shrimp fishers was over \$650 000. Graham et al.(2003) estimate that clogging of shrimp nets in Louisiana by jellyfish was estimated to have cost millions of dollars in economic losses. Nastav et al. (2013) conclude that large jellyfish abundances in 2004 had a negative impact on Slovenian fisheries - reducing catches, income and employment but do not quantify the losses. They also conclude that the effect on the regional economy was low.

Potential losses caused by jellyfish blooms are clearly large with an increasing number of studies trying to quantify this impact. Studies using revealed preferences and questionnaires have started to quantify these impacts but further research is necessary to ascertain the full economic costs of jellyfish blooms. This study is the first which tries to quantify the economic impact on tourism (beach users), fisheries (predation of fish larvae) as well as the wider impact on the regional economy. The model can be improved once the necessary data and knowledge becomes available but is a valuable first attempt at analysing this issue. The inclusion of mitigation methods in the model, such as nets preventing jellyfish stranding could provide further useful insights. Given the availability of relevant data, the structure of this model can be used both with other species of jellyfish in the study zone, as well as with other species in different zones.

### 3.7.2 Discussion of the SAF application

It is debatable whether this study can really be considered a true application of the Systems Approach Framework. Although the original intention was to follow the SAF methodology, unforeseen circumstances prevented this from happening. When the contract for the VECTORS project was granted enabling the scientific team to attempt another SAF application, there was initial interest from stakeholders who participated during the SPICOSA project. A true SAF application would involve a dialogue with the relevant stakeholders who would provide both their



insight into an issue as well as a continued interest in the development of the model and its results. However in this case, there were not any stakeholders willing to participate in the process mainly due to a lack of human resources in the relevant institutions (Catalan water agency, the fisheries department of Catalonia, Port authorities, and Barcelona council). They had to prioritise their time to their daily work commitments and did not have the necessary time to invest in this SAF application. Therefore given that the contract had already been granted, the scientific team decided to continue from a purely theoretical perspective but using just the modelling methodology as outlined in the SAF. This clearly had an effect on the outcome of the SAF application as there were not any (non-scientific) stakeholders involved. However, this does not mean that insights cannot be gained from this attempted SAF application, although they will generally be limited to the modelling component of the SAF.

A key lesson learned during this SAF application is the importance of availability of data and knowledge. Whereas the fisheries sub-model was based on a pre-existing model (MEFISTO) which had been used with various species by members of the scientific team, the other sub-models were much more experimental, and the scientific team had little previous experience with them. For example, the original intention was that the stranding sub-model would be developed within a different project and later shared with the scientific team involved in the SAF application. However, there was a delay in construction so we had to create our own model which was simplified to the model originally planned. The effect of stranding events on beach users was analysed by another team within the VECTORS project. However, there was a lack of communication between the two teams and output of the analysis of the stranding-beach user model was not particularly useful for the aims of the SAF application. The output of the stranding-beach user model only calculates the amount (in time and money) beach users would be willing to spend to travel a little further in the same region to a different beach. This would have little to no effect on the region as a whole as some businesses would suffer and other businesses would benefit by the same amount. A better analysis more relevant to the SAF application would be to elicit or even directly measure possible effects on international tourists and how their decisions might be affected by increased jellyfish stranding events.

As highlighted by this study and by Tomlinson et al. (2011), the greatest limitation of the SAF is convincing the relevant stakeholders and institutions to participate in the process. They can be reluctant to do so, partly because they might not perceive any benefit in doing so, or because they do not have the necessary time and personnel resources to do so. However, the model can still be

seen as useful in informing stakeholders about the bioeconomic impact of jellyfish on fisheries in possible future deliberations when interest arises and resources are available.

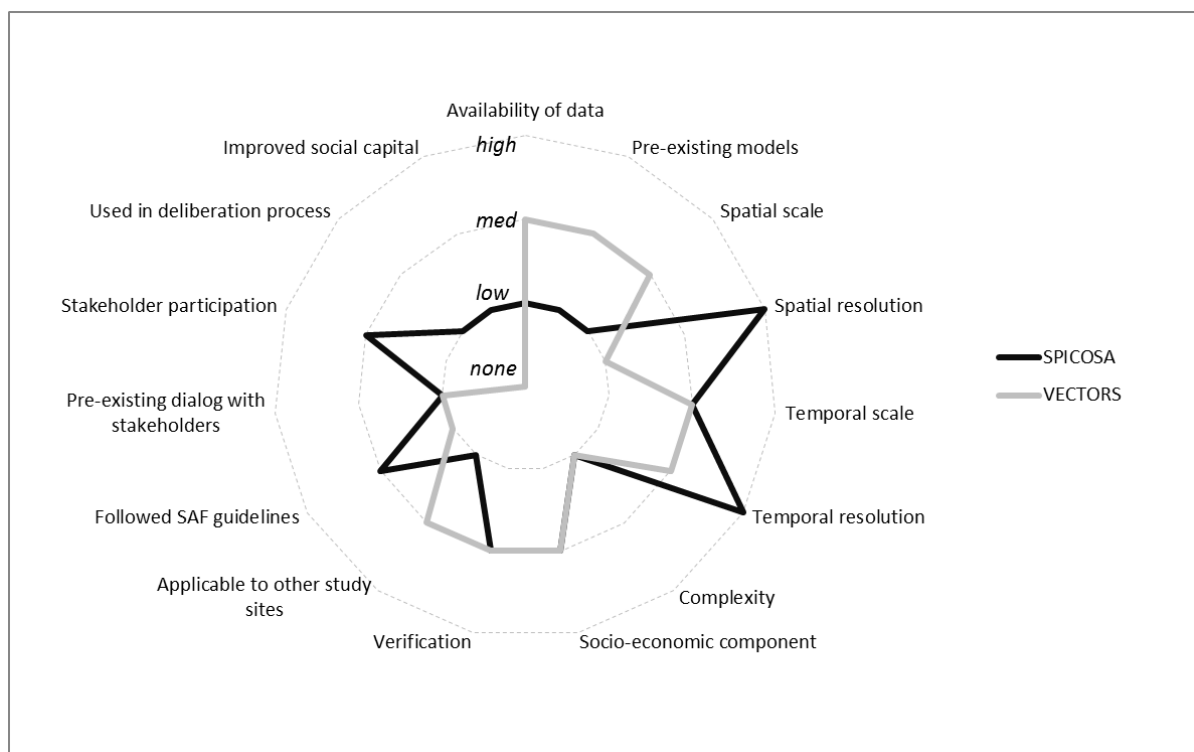


## 4 Discussion

### 4.1 Comparison of the SAF applications in the SPICOSA and VECTORS projects

The Systems Approach Framework was applied in Catalonia with different levels of stakeholder engagement, regarding different issues across differing scales. However, it is still valid to compare the two applications as the initial intention was to use the same methodology. Comparisons can be made between both the modelling aspect of each SAF application as well as the interaction with policy makers, managers and other stakeholders. The applications were successful in some aspects and less so in others, but there were lessons learnt from both. Various aspects of each SAF application are described below as either being “none”, “low”, “medium” or “high”. These classifications are necessarily subjective and contextual. The classifications have been made in terms of comparison to other SAF applications (from the other 17 study sites in the SPICOSA project), as well as modelling and managing social-ecological systems in general. The classifications do not necessarily reflect quality, they are merely descriptors. For example, a model with a “high” spatial scale is not necessarily “better” than a model with a “low” spatial scale (Fig. 52).

Fig. 52: Comparison of SPICOSA and VECTORS application



- Availability of data

The SPICOSA application was considerably constrained by the limitations in the available data. Much crucial information regarding the functioning of the sewerage network was unavailable to the scientific team. Various important parameters were approximated or simplified such as the faecal coliform and suspended solid concentration in the CSO and river. However the most important missing data was that regarding the effect of bacteria and turbidity on the recreational appeal of the beach users. This meant that the model results had to be presented within a range of theoretical possibilities. If there had been resources within the project to ascertain these data then the model would have probably had a greater impact.

There was more data available for the model in the VECTORS project. The fisheries sub-model was populated with reliable high resolution data. However, many parameter estimations were made in constructing the jellyfish sub-model, and given that this was the principal driver of the model, has implications for the rest of the model output. Higher temporal and spatial resolution data regarding the *P. noctiluca* population, predation rate (on the small pelagics), and strandings would have greatly improved the validity of the model.

SPICOSA: low

VECTORS: medium

- Availability of pre-existing models

There were no pre-existing models available for the SPICOSA application. There was a requirement by the SPICOSA project to use the ExtendSim software which is beneficial for constructing modular block models, but less effective in evaluating spatially explicit problems. The model in the SPICOSA application was constructed with this limitation but the components were based on simplifications (if necessary) of pre-existing models available in peer-reviewed literature (e.g. bacteria decay rate, flux of combined sewer overflow within beach water, travel-cost method).

The fisheries sub-model of the VECTORS project was based on the pre-existing model MEFISTO, although adjustments still had to be made (primarily changing the time-step). The jellyfish sub-model was based on the standard population matrix model. However the model had to be

populated using data relevant to the study site. The stranding model was calculated by correlating modelled jellyfish in the sea to historic observed strandings. The effect on beach users was based on a study undertaken simultaneously by other researchers within the VECTORS project, but the structure of their research, and therefore their findings, were not particularly relevant to the model.

Using the classification system of IAM models referred to in Chapter 1.3 (Kelly et al. 2013), both the SPICOSA and VECTORS models can be described as a coupled component model (CCM). The SPICOSA model has components which use system dynamics (i.e. the combined sewer overflow, beach water clarity, and beach water bacteria sub-models), which the VECTORS model does not. However the reason for selecting a coupled component model was different in each application. Using the decision tree described in the introduction (Fig. 1 in Chapter 1.3), a CCM model was chosen in the SPICOSA application due to importance of understanding the “breadth of the system”. However, given the more narrow focus of the VECTORS application, the decision to use a CCM was due to the “depth of specific processes” (i.e interaction between jellyfish and small pelagics).

SPICOSA: low

VECTORS: medium

- Spatial scale

The SPICOSA SAF application was applied at the scale of the city (of Barcelona) whereas the VECTORS application was at the regional scale of the Spanish autonomous community of Catalonia.

SPICOSA: low

VECTORS: medium

- Spatial resolution

The SPICOSA model has a relatively high spatial resolution, modelling each beach individually, although the number of beach users are aggregated before calculating the non-market value of

all beaches together. The VECTORS model has a low spatial resolution in that there are only three zones for the whole study area. This was perhaps a limitation in being able to adequately model jellyfish strandings per beach as discussed in Chapter 3.7.1.

SPICOSA: high

VECTORS: low

- Temporal scale

Both models have a limited accurate forecast period of between five to ten years. Perhaps the SPICOSA model has a marginally longer forecast period than the VECTORS model due to the physical nature of the model. However, policy decisions such as investing in stormwater collectors (or reducing expenditure on beach regeneration – which is not modelled) could have important implications for the model. The VECTORS model does not claim to accurately forecast for the long-term either. Fisheries models are generally weak in long term predictions due to the adaptive behaviour of the fishermen and complex nature of trophic effects on food webs. The SAF was designed as an iterative process so that changes or shocks in both the social and ecological systems can be included in future iterations. It is therefore unsurprising the temporal domain of both models are not long-term.

SPICOSA: medium

VECTORS: medium

- Temporal resolution

The SPICOSA model was constructed with a high temporal resolution (daily time-step) in order to capture the temporal sporadic nature of combined sewer overflow events. The VECTORS model has a monthly time-step, so that it can capture the dynamics of the seasonal predation of *P. noctiluca* on anchovy larva.

SPICOSA: high

VECTORS: medium

- Complexity of model

Although there is no universally accepted definition of “complexity”, here it refers to the extent in which the various components interact with each other in multiple ways. Part of the objective of the SAF is to model the complexity of social-ecological systems, and of particular importance is the feedback between components. Both models of the SPICOSA and VECTORS applications can be considered complicated in the sense that there is difficulty in constructing the model and require experts in order to do so. However, neither model is complex as there is no feedback between components as both models are linear.

SPICOSA: low

VECTORS: low

- Social and economic component

SAF models should include the socio-economic components of the system within the model and connect them to the ecological components in order to capture the complete dynamics of the system. Both the SPICOSA and the VECTORS models included economic valuation components within the system and were linked to the ecological component. The social component was not directly modelled in either model, but in the SPICOSA model various management and scenario options can be run. This partially captures the social component of the system.

SPICOSA: medium

VECTORS: medium

- Verification of the model

Verification of the model depends on the data and knowledge available to populate the model, the implementation of the model, and the availability of data to verify the output. The SPICOSA application suffers from a lack of available data, however various components were adequately verified (beach water bacteria sub-model, beach water clarity sub-model and the travel-cost method). The unknown components (sewerage functioning, beach user sensitivity to water quality) were modelled as scenario options and have not yet been verified. Despite this, the overall conclusions of the model (that there are diminishing returns in building further



stormwater collectors to improve water quality) were coherent with the instincts of some of the stakeholders (ACA).

Although the VECTORS fisheries sub-model is sufficiently verified against observed data, there is a lack of data regarding the *P. noctiluca* population or stranding model. Despite this, the results the model produces are within an expected range of authenticity.

SPICOSA: medium

VECTORS: medium

- Applicable to other study sites

The SPICOSA model is quite site specific in regards to the positioning of the CSO overflows, the river and the wastewater treatment plant. The model is calibrated against observed data taken from the beaches of Barcelona. In order to reproduce a similar model at another area, time series data of bacteria and turbidity would need to be collected for a few years. Certain components would be more easily transferable such as the non-market valuation (travel costs method) but again would need data relevant to the new study site. An evaluation of the beach user sensitivity to water quality would also need to be undertaken (also unavailable for this case study) as this would likely be specific to users for a given beach.

The VECTORS model could be applied to other study sites given that the population dynamics of fisheries and *P. noctiluca* could be similar to other areas. Data would still need to be collected to determine the absolute population size for both though. Jellyfish strandings and beach user sensitivity to strandings would also need to be re-calibrated.

It should be noted that the SAF was conceived as being a site-specific methodology so a low applicability to other sites is not surprising.

SPICOSA: low

VECTORS: medium

- How closely were the SAF guidelines followed?

The SAF methodology was developed during the SPICOSA project. The SAF application in Barcelona followed the guidelines as closely as possible – particularly regarding stakeholder analysis, issue identification, and constructing the model. However, due to low interest from the stakeholders, it was not possible to involve them in designing the model, choosing scenarios and indicators. Although the completed model was presented to the stakeholders, it was not used in deliberation for deciding future management or policy decisions.

Although the initial intention was to apply the SAF methodology in the VECTORS project, the lack of response from the stakeholders prohibited including a large part of the methodology relevant to stakeholder participation. However, the modelling methodology from the SAF was used to create a social-ecological model, and proved beneficial in this aspect.

SPICOSA: medium

VECTORS: low

- Was there a pre-existing dialogue/forum between stakeholders?

For the SPICOSA application, the scientific team organised the stakeholder meetings as they were unaware of the existence of any pre-existing forum. Towards the end of this SAF application, they became aware of an existing forum although it operated at a different scale to the SAF application. However, it might have been beneficial to use this forum to launch the initial dialogue to encourage the relevant stakeholders to participate in the SAF application. For the VECTORS application, various stakeholders were invited to attend the initial meeting but no one chose to attend due to time and resource limitations.

SPICOSA: low

VECTORS: low

- Stakeholder participation during application

An initial meeting was organised by the scientific team at the beginning of the SPICOSA application and was attended by five stakeholders. The Catalan Water Agency (ACA) was the

stakeholder most interested in the SAF application and continued to support the scientific team during the process. Towards the end of the project ACA invited us to a larger forum organised at the regional scale to present the SAF methodology and our model and results. Following this meeting there was interest shown by various stakeholders from the rest of Catalonia regarding the model and the methodology.

No stakeholders participated in the VECTORS application.

SPICOSA: medium

VECTORS: none

- Was the model or SAF used in any deliberation process?

The model results were presented in the final meeting but there was no time for deliberation as the agenda covered many diverse issues, not just that presented by the scientific team. Various stakeholders expressed an interest in the results we presented but there was no time left in the project to further discuss the issue. Possibly given more time, then the model would have been used as a starting point for a dialogue between the relevant stakeholders.

No stakeholders participated in the VECTORS application so it was not used in deliberation for any management or policy decision.

SPICOSA: low

VECTORS: none

- Improved social capital?

In the SPICOSA application there was not much improvement with social capital between the stakeholders. Attendance by the stakeholders decreased during the application, possibly as they did not see the benefits of the project. At the final meeting, the scientific team had the opportunity to show both the methodology and model, both of which created interest in some stakeholders. If there had been more time within the project or with external funding, this could have helped to improve the dialogue between stakeholders.

No stakeholders participated in the VECTORS application so there was no change in social capital.

SPICOSA: low

VECTORS: none

#### 4.2 Comparison with other SAF applications and IAMs in coastal systems

The SPICOSA application was compared with other SAF applications involving similar issues in Chapter 2.7.1. There have not yet been any SAF applications similar to the VECTORS application. The insights gained from the other 17 SPICOSA study site applications will now be compared with those from this thesis.

There was large variation between the study sites regarding policy effectiveness, due to institutional and cultural differences as well as stakeholder participation. For example, the scientific team from the SAF application in the Guadiana Estuary, Portugal had difficulty encouraging some of the stakeholders to participate in the process (Guimarães et al. 2012). The Guadiana Estuary shares a border with both Spain and Portugal. Although the Portuguese stakeholders attended the meetings, their Spanish counterparts were less interested. This could have been due to issues regarding a conflict of interests, time and resources available to the stakeholders or maybe familiarity with the scientific team (who were Portuguese). The study site in Venice Lagoon had the problem of illegal fishing which complicated both, collecting reliable data as well as encouraging stakeholder participation (Melaku Canu et al. 2011). Some study sites stated that there were also scaling difficulties between the highlighted issue and the lack of ability to affect it, where those that could most influence the impact were operating a different scale, and therefore outside of the group of stakeholders participating in the SAF (Hopkins et al. 2012). Although a solution would be to try to involve those stakeholders in the process, practically this is difficult to implement. These issues were certainly present in the SPICOSA and VECTORS applications presented in this thesis as previously discussed.

On the other hand, some study sites reported that the SAF improved social capital, encouraging dialogue between stakeholders and policy makers, and created a shared understanding of the system. Dinesen et al. (2011) reported that the SAF helped to defuse a three-way conflict between mussel fishers, mussel aquaculture and nature conservationists in Limfjord, Denmark. The SAF

helped to propose a new natural-resource-based tourism in the Risør Fjord, Norway whilst analysing a trade-off between tourist fishing and conservation of the local cod population (Moksness et al. 2011). In the Pertuis Charentais area, France, the SAF helped stakeholders understand the complicated dynamics involved in freshwater distribution and expected this social learning exercise to continue, encouraging other stakeholders upstream to participate in the process (Mongruel et al. 2011).

For most scientific teams and stakeholders, there had been limited dialogue between them previous to the SAF application and both groups reported the process to be beneficial. Most stakeholders felt the simulation analyses helped them to better understand the system, and expressed interest in future collaboration using the SAF (Hopkins et al. 2012). This was also true in the SPICOSA application in this thesis, but not in the VECTORS application due to the lack of stakeholder participation.

On the technical side of building a simulation model, most study sites had trouble finding adequate data. Although part of the SPICOSA requirements for a study site to participate in the project was to already have data collected from previous studies, many found that this data was not sufficient. Alternatives were sought (proxies, estimations, expert opinion) and occasionally additional data was collected. This was particularly true with socio-economic data, where there was generally a lack of surveys regarding public perception of an issue (Hopkins et al. 2012). This was true for both SAF applications in this thesis where there was no data regarding public perception of water quality and jellyfish and how it might influence a beach user's decision to visit another beach. In the SPICOSA application this unknown data was left as a scenario option within the simulation model, whereas in the VECTORS model a survey was undertaken to elicit this information. One of the conclusions of the SPICOSA project was that there needed to be an improvement in multidisciplinary databases specific to study zones in order to adequately analyse social-ecological systems (Hopkins et al. 2012).

Although all study sites were capable of constructing conceptual models linking ecological, social and economics components of the system, many had difficulty in quantifying the link for the simulation model. Other processes involving thresholds (particularly social thresholds), tolerances, illegality and public acceptance proved particularly difficult to validate in the simulation model (Hopkins et al. 2012). Many study sites used non-market economic valuation techniques in their models such as the travel-cost method used in the SPICOSA application (Chapter 2.4.5.2) and the stated choice experiment in the VECTORS application (Chapter 3.4.4.2). These types of valuation techniques were

new to most stakeholders so the methodology and implications had to be carefully communicated to them. These valuation techniques helped the stakeholders to understand the value of certain policy decisions which might not bring short term economic (monetary) benefits (Hopkins et al. 2012).

Additional information regarding the lessons learnt and insights drawn from the SAF during the SPICOSA project is described in Hopkins et al. (2012) and Bailly et al. (2011).

Kelly et al. (2013) identified 64 studies which used integrated assessment models (IAM) across a range of disciplines. They classified each study depending on the type of model used: System dynamics (10 studies); Bayesian networks (15); Coupled component model (18); Agent-based model (11); and Knowledge-based model (10). A description of each type of model can be found in the introduction (Chapter 1.3). Of these 64 models, there were four related to coastal zone issues. Although the paper by Kelly et al. (2013) does not claim to be an exhaustive list of all IAM studies, it is interesting to note that there were over 21 studies related to freshwater resources/catchment management.

Only one study (of the four which focused on coastal zone issues) used a modelling approach similar to the SAF - Chang et al. (2008) used system dynamics to model the coastal zone of Kenting, Taiwan, where there is increasing pressure on the coral reef due to tourism and fishing. Four management scenario variables are controllable in a user-friendly decision support system including: land development, wastewater treatment, coral fish consumption rate, and entrance fee (to coral reef). Change et al. (2008) accept that the decision-makers might not accept some of the options available to them (i.e. limiting fishing access) but at least they can see the effect this option would make. However, they do not say if the model was actually presented to stakeholders or decision-makers, and whether there was any dialogue or deliberation using the IAM. This is also the case with the other three coastal zone IAMs presented in Kelly et al. (2013). Two of these studies used Bayesian networks for fisheries management in the Baltic sea (Kuikka et al. 1999, Levontin et al. 2011) and the other used an agent-based model for recreational fishing in Ningaloo Marine Park, Australia (Gao and Hailu 2012). None of these studies reported on any interaction with stakeholders and whether it was used in any deliberation process. This does not mean that this did not occur, but from the studies it is difficult to assess what level of stakeholder integration occurred.

This lack of information regarding stakeholder integration in IAMs seems to be common within the scientific literature. There are many integrated models across a broad spectrum of disciplines but

most of the peer-reviewed literature only reports on the details of the models, rather than the whole process of integrating stakeholders. There is no easy way of knowing to what extent the stakeholders were involved in the process, whether the model was used in deliberation, whether the stakeholders found the model beneficial in understanding the system, nor whether there was any policy/management decision made during deliberation. For IAM to evolve it is important to understand what works and what does not: When were the stakeholders contacted? Who was contacted? To what extent were they involved in designing the (conceptual or simulation) model? What type of model was used? How was the model presented to the stakeholders? And was any decision made during deliberation using the model as a shared vision of the system?

The reasons why until now this has not happened is partly due to the (relatively) recent innovation of using IAMs, and the acknowledgement that stakeholders should be “integrated” into the process. A second reason is due to the way publishing in science works. Researchers are under constant demand to publish innovative work. As soon as a model has been completed, they want to publish the model and its results. This does not allow sufficient time for the model to be used in a deliberation process, and publish the whole process together. Additionally most journals limit the amount of space available per article. It would be difficult to explain both the model and the process in sufficient detail in just one article and publishers tend to prefer the technical rather than the social aspect of IAM, although there are some journals which accommodate both.

Ideally, there should be an easy way for researchers to attach addendums to their published work outlining details of stakeholder participation and deliberation using their models. If this were the case, there would be the possibility of tracking an IAM study over time to identify which processes encouraged stakeholder participation, and the outcome of any decisions made during deliberation with the IAM.

#### 4.3 Resilience adaptive management

Although integrated assessment modelling is increasingly being used in management of social-ecological systems, there are few step-by-step methodological frameworks such as the SAF which have tried to formalise this process. A similar framework is Adaptive Management (AM) initially conceived by Holling (1978) and Walters (1986) - sometimes referred to as Adaptive Environmental Assessment and Management. Holling (2001) and his colleagues (Folke et al. 2002, 2010, Folke 2006)

established a path for understanding complex social-ecological systems within a transdisciplinary framework in which the concept of *resilience* is the guiding principle. Resilience of social-ecological systems can be defined as the capacity of a system to absorb shocks or disturbances so that the system retains or can easily return to the same basic structure of functioning (Holling and Gunderson 2001). The aim of AM is to either maintain the system within the current regime such that the desired ecosystem goods and services are continued to be delivered, or move the system phase to a preferred regime (Walker et al. 2002, Chapin et al. 2009). Key objectives of AM include making explicit underlying assumptions and identifying unknown issues. This helps reduce the use of “best guess” strategies and strengthens the link between knowledge and action (Holling and Meffe 1996, Westley 2001).

The following are considered to be vital procedural components of adaptive management (Holling 1978, Walters 1986, Walker et al. 2006, Allen and Gunderson 2011):

- consideration of appropriate temporal and spatial scales
- use of computer models to build synthesis and an embodied ecological consensus
- use of embodied ecological consensus to evaluate strategic alternatives
- communication of alternatives to political arena for negotiation
- inclusion of all relevant stakeholders
- political openness
- social and scientific processes
- encouragement regarding the formation of new institutions and strategies
- enhancement of institutional flexibility

Adaptive management and the Systems Approach Framework share the common philosophy that the process of management should be both social and scientific, and should involve stakeholders in constructing conceptual models (mathematical or otherwise) to improve the understanding of the system (Walker et al. 2006, Chapin et al. 2009); to use different knowledge systems, including both local and scientific; to integrate various disciplines; and during decision-making and deliberations with stakeholders. AM advocates “social network analysis” (Ernstson et al. 2008), and the SAF suggests, although does not necessarily require, the use of stakeholder mapping. Both techniques are employed to understand the existence of social relations, how they relate to each other, and the power structure within and between them (Reed et al. 2009, Prell et al. 2009).



When constructing a mathematical model, it is necessary to choose both a spatial and temporal scale. However, it is important to remember that the system itself is in a nested hierarchy of other systems that are all evolving through their own adaptive cycle (Holling and Gunderson 2001). The SAF does not attempt to model these nested adaptive cycles, but during System Formulation, the importance of the differences in scale between and within components becomes evident.

The SAF could generally be classed as being similar to a “passive” AM approach (Holling 1978, Walters 1986, Holling and Meffe 1996, Chapin et al. 2009), although this depends on the system in question, the stakeholders involved, their vision of the social-ecological system, and its associated issues. Passive AM uses whatever knowledge and information is available to improve the decision-making process. On the other hand, “active” AM tests the real system, pushing it to (ecological) limits in ways that would not normally be tried, thus providing learning about possible regime shifts and a more complete understanding of the social-ecological system. Often, as in our case study, the objective of most policy makers and stakeholders is to maintain the social-ecological system in its current phase and not try to push it to another.

Most procedural components of AM are also advanced by the SAF methodology. However, it should be noted that there is not always a direct one-to-one correlation; thus, some components of AM are referred to in more than one SAF “step”. This is not surprising given that we are comparing a step-by-step methodological guide (SAF) against a tool for management with generalized recommendations (AM). There are two components of AM that are not explicitly recommended by the SAF (“Encourage the formation of new institutions and strategies” and “Enhance institutional flexibility”), but neither does the SAF discourage them.

Conversely, there are no obvious SAF steps or tasks that could be considered outside of, or contrary to, the recommendations of AM. However, the SAF is more specific in its methodology—for example, in its use of General Systems Theory and system dynamics as the foundation for modelling, and in recommending software that can be easily used by layperson stakeholders. Both the SAF and AM recommend considering the issue across different temporal and spatial scales. However, within the SAF, a specific scale has to be chosen in order to create a model, although this could change over additional iterations of a given application. AM does not specify exactly how to confront the difficulties involved in creating a computer model across various temporal and spatial scales.

There are a number of subtle differences between the SAF and AM in terms of the emphasis of objectives and procedures. For example, in the SAF, the process starts with scientists who choose a set of stakeholders and together they investigate an issue by choosing the relevant scale together. On the other hand, AM has little to say about how the process starts or whether it should focus on just one management issue or model the entire ecosystem. Because of this, it could be argued that the SAF puts greater emphasis on solving individual issues, decision-making processes, and sustainability, whereas AM puts greater emphasis on sustainability, resilience (passive AM), and testing and learning from the ecosystem (active AM).

#### 4.4 The future of the Systems Approach Framework

It is difficult to suggest improvements to the design of the SAF because it is an open methodological framework. The most technical aspects of the methodology, such as stakeholder interaction and construction of the model, are not rigidly defined, and are therefore open to a degree of interpretation. This has the obvious drawback of requiring experts to aid in the process but leaves it sufficiently open so that the methodology can be applied to a diverse set of issues across varying cultural and political communities.

Similar to any social policy or strategy, it is difficult to predict the future trajectory that the SAF will take. As a tool for management, it requires significant time, resources, and personnel. For the process to run smoothly, there needs to be transdisciplinary scientists or at least scientists capable of understanding and communicating outside of their own specialization, modellers who can interact with all disciplines and are familiar with general systems theory, and social scientists trained in stakeholder deliberation. The true limitations might lie in attempting to confront the existing power structure of institutions and organizations by convincing them to engage in the process.

The VECTORS application was not able to trial the SAF methodology as proposed in the project proposal because it proved to be impossible to persuade any external stakeholders to assist the project. This included policy makers who could have adopted, executed or implemented the results. The SPICOSA application did benefit from some stakeholders' assistance, but not all. A key stakeholder refused to participate because they (correctly) surmised that it was not in their interests for the project to succeed as they stood to lose financially if the results were implemented. The inclusion of stakeholders in the SAF methodology is rightly fundamental, but in practice, it can be

extremely difficult to persuade key stakeholders to participate, and this is a flaw in the SAF which needs addressing.

The SAF methodology embodies a political process. Different classes of stakeholders often have different interests. An application may be financed by one class of stakeholders, to the possible detriment (or benefit) of others, and the decision-making process may rest with another class of stakeholders. Application models are dependent on stakeholders sharing important data or knowledge but this may be withheld for a variety of reasons including, but not limited to, lack of resources to participate, disinterest, concern about how the results will be used.

This problem seems to be more acute in southern European countries because (unlike northern European countries) there is a weaker tradition of stakeholder participation in projects. More should be done to disseminate the benefits of the SAF methodology to policy makers and other stakeholders to encourage take up. At the project proposal stage, contact should be made with key stakeholders. Joint partnerships could be set up to bind key stakeholders to the project. Incentives would need to be offered, and the prime one will always be to produce results that are useful to the stakeholders. This is to be welcomed as it enhances the project.

Perhaps an early optional broad and shallow phase could be added to any SAF project, to be implemented when stakeholders have not been co-opted in advance of the project. This phase would be used to engage with all possible stakeholders, to ascertain which stakeholders' participation is crucial for the process. If it is found that key participation will be withheld, this early phase could be used to redirect the project in a way that stakeholders find more amenable. But it is crucial to bear in mind that as the SAF methodology is used to model real-world interactions, any results used will impact people's lives. If people perceive that the impact will be negative, they may well wish to see the project fail. So it is important to identify ALL stakeholders not just the policy makers, i.e. who is affected by the application? Who wants this application done? Who stands to benefit? Who stands to lose? Whose input is crucial for the study? Where the broad and shallow phase identifies that a key problem for stakeholders' participation is lack of resources, consideration should be given to instigating a SAF light version i.e. one with minimal involvement. This may not be ideal, but it would be much better than no involvement at all.

Although the aim of the SAF is to manage coastal zone system towards sustainability, there remain questions regarding the scale of some of the issues involved. Many issues affecting coastal zone

systems around the world are beyond the scope of local or regional governance to be able to address singularly. Large scale issues affecting coastal zones such as loss in biodiversity, climate change, over-population, and over-extraction of resources are managed externally to coastal zones (or not at all in some cases) and require international agreements. It is beyond the expectations of the SAF to directly address these issues, but involving local stakeholders in the decision making process with local issues will hopefully increase awareness and willingness to cooperate at larger scales.

Despite these problems encountered with applying the SAF during the SPICOSA and VECTORS projects, there were clearly benefits related to designing, building and testing the modelling aspect of the methodology. The scientific team did not have much experience with social-ecological modelling beforehand and most thought that the process was interesting – especially modelling the socio-economic aspects of the system. The transdisciplinary aspect of the SAF encouraged researchers who normally only focussed on their specific research topics, to engage with researchers from other disciplines.

The SPICOSA and VECTORS projects were funded by the European Union (by the Framework Programme for Research and Technological Development). However, such research funds cannot subsidize all future implementations of the SAF - there has to be shared responsibility between science and policy. Obviously, for the policy makers to invest in the process and justify the expenditure at the political level, they would have to see the benefits either from previous implementations of the SAF or from envisaging the possible advantages of future iterations.

The SAF is a well-structured methodology for cases where a mathematical model is both relevant and feasible with regards to both knowledge of the functioning of each component of the social-ecological system and the availability of data, resources, and personnel. The SAF should be considered as a useful step-by-step guide for managing coastal zone systems towards sustainability.



## 5 Conclusions

### SPICOSA application

- The model developed in the SPICOSA application demonstrated that the stormwater collectors have been useful in improving beach water quality in Barcelona, but there will be diminished returns in constructing more.
- The economic value of the beach is clearly large in terms of both non-market value and revenues generated in the nearby bars and restaurants. The impact changes in water quality would have on the recreational appeal of the beach is estimated to be low but further research is recommended to determine beach users' sensitivity to beach closures (bacteria limit exceeded) and turbidity.
- The SPICOSA Systems Approach Framework (SAF) application highlights an important aspect of participatory management. It demonstrates that a deficit in social capital can seriously deter any participatory management process. However, for social capital to be built, confidence between the stakeholders needs to increase. The SAF methodology offers an opportunity for this to occur.
- Further iterations of the SAF could increase social capital, improving participation and the decision making process. There needs to be real engagement between the stakeholders and not treat it just as a "game" or hypothetical situation for the interest only of the scientists.

### VECTORS application

- The results of the scenario analysis from the VECTORS application show that *P. noctiluca* has a low impact on small pelagic fisheries, beach users and the regional economy.
- This analysis should be viewed as a first attempt at analysing the complex effect of jellyfish on fisheries and beach tourism, and would be greatly improved by including further jellyfish species once the relevant data is available. This study only analyses the effect of *P. noctiluca* on fisheries and beach users when there are over 12 species of scyphomedusae in the region.

- This study is the first which tries to quantify the economic impact on tourism (beach users), fisheries (predation of fish larvae) as well as the wider impact on the regional economy. The model can be improved once the necessary data and knowledge becomes available but is a valuable first attempt at analysing this issue.
- The greatest limitation of the SAF is convincing the relevant stakeholders and institutions to participate in the process. They can be reluctant to do so, partly because they might not perceive any benefit in doing so, or because they do not have the necessary time and personnel resources to do so. However, the model can still be seen as useful in informing stakeholders about the bioeconomic impact of jellyfish on fisheries in possible future deliberations when interest arises and resources are available.

#### The Systems Approach Framework (SAF)

- Both SAF applications were considerably constrained by the limitations in the available data. This meant that the models results had to be presented within a range of theoretical possibilities. If there had been resources within the projects to ascertain these data, this would have had a greater impact.
- There are many integrated models across a broad spectrum of disciplines but most of the peer-reviewed literature only reports on the details of the models, rather than the whole process of integrating stakeholders. There is no easy way of knowing to what extent the stakeholders were involved in the process, whether the model was used in deliberation, whether the stakeholders found the model beneficial in understanding the system, nor whether there was any policy/management decision made during deliberation. For Integrated Assessment Modelling (IAM) to evolve it is important to understand what works and what does not.
- There should be an easy way for researchers to attach addendums to their already published work outlining details of stakeholder participation and deliberation using their models. If this were the case, there would be the possibility of tracking an IAM study over time to identify which processes encouraged stakeholder participation, and the outcome of any decisions made during deliberation with the IAM model.

- The inclusion of stakeholders in the SAF methodology is rightly fundamental, but in practice, it can be extremely difficult to persuade key stakeholders to participate, and this is a flaw in the SAF which needs addressing. SAF Application model builders are dependent on stakeholders sharing important data or knowledge but this may be withheld for a variety of reasons including, but not limited to, lack of resources to participate, disinterest, concern about how the results will be used.
- An early optional phase could be added to any SAF project, to be implemented when stakeholders have not been co-opted in advance of the project. This phase would be used to engage with all possible stakeholders, to ascertain which stakeholders' participation is crucial for the process. If it is found that key participation will be withheld, this early phase could be used to redirect the project in a way that stakeholders find more amenable.
- Although the aim of the SAF is to manage coastal zone system towards sustainability, there remain questions regarding the scale of some of the issues involved. Many issues affecting coastal zone systems around the world are beyond the scope of local or regional governance to be able to address singularly. It is beyond the expectations of the SAF to directly address these issues (externalities), but involving local stakeholders in the decision making process with local issues will hopefully increase awareness and willingness to cooperate at larger scales.
- Despite problems encountered with applying the SAF during the SPICOSA and VECTORS projects, there were clearly benefits related to designing, building and testing the modelling aspect of the methodology. The transdisciplinary aspect of the SAF encouraged researchers who normally only focused on their specific research topics, to engage with researchers from other disciplines.
- The SPICOSA and VECTORS projects were funded by the European Union. However, such research funds cannot subsidize all future implementations of the SAF - there has to be shared responsibility between science and policy funding agencies. Obviously, for the policy makers to invest in the process and justify the expenditure at the political level, they would have to see the benefits either from previous implementations of the SAF or from envisaging the possible advantages of future iterations.
- The SAF is a well-structured methodology for cases where a mathematical model is both relevant and feasible with regards to both knowledge of the functioning of each component of the social-ecological system and the availability of data, resources, and personnel. The SAF



should be considered as a useful step-by-step guide for managing coastal zone systems towards sustainability.

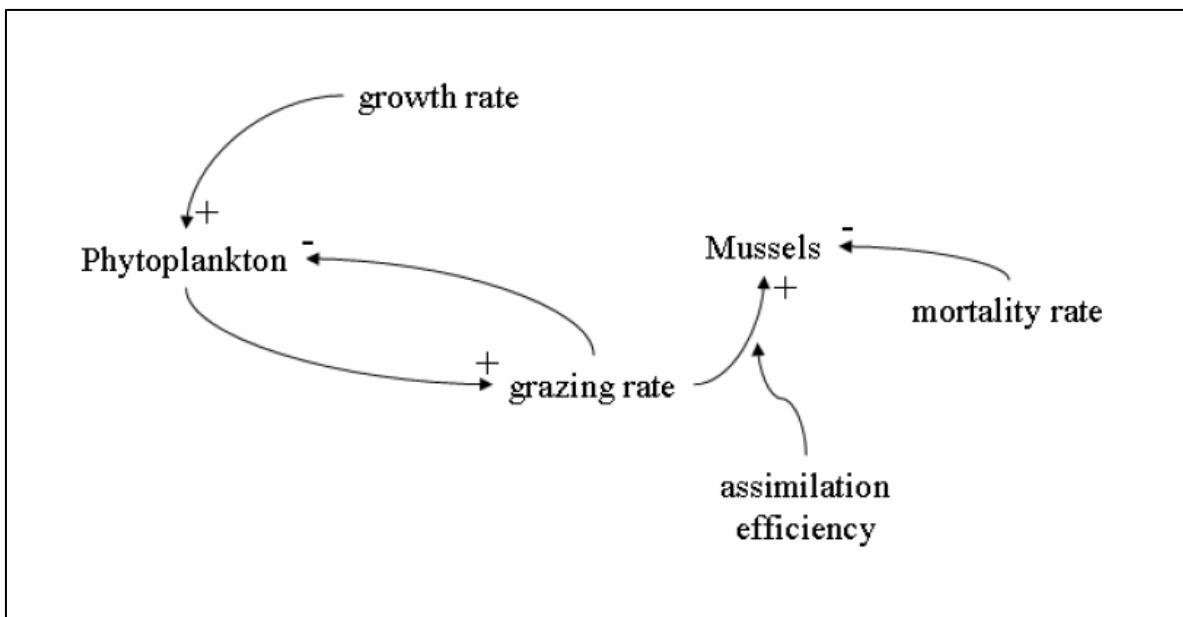
## 6 Appendices

### Appendix I: Constructing a SAF model

This is an example of how a simple system can be modelled using the methodology described in the SPICOSA project. This example is taken from an internal SPICOSA project document designed to help modellers in constructing SAF models. (Note that the author (or authors) is not stated on the document but the work package co-ordinator was Cédric Bacher from IFREMER.)

The model represents a simple predator-prey relationship between mussels and phytoplankton. First a causal loop diagram is constructed showing the interaction between the mussels and phytoplankton. The links are given a direction and whether they are positive or negative. Note there is a feedback loop between the grazing of mussels on the phytoplankton.

Fig. 53: Causal loop diagram of mussel predation on phytoplankton



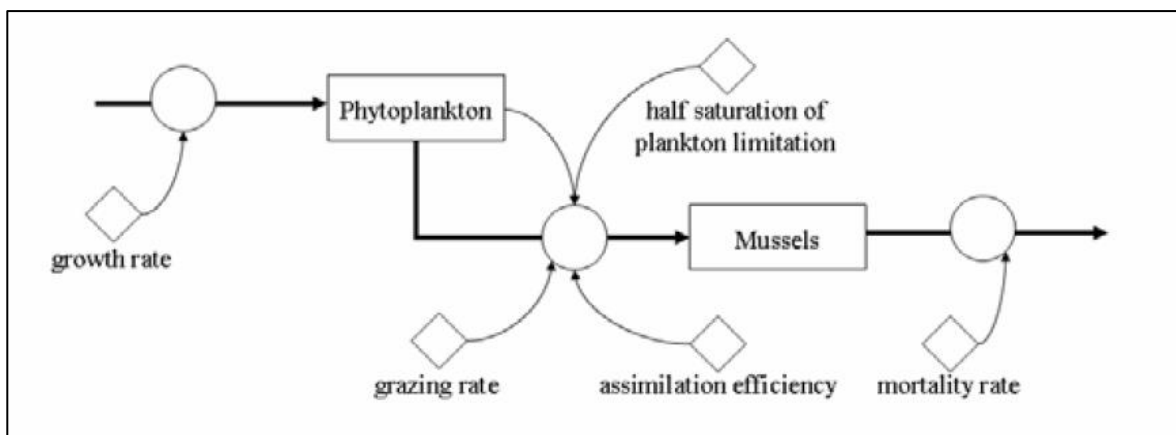
Grazing by the mussels on the phytoplankton increases their biomass. The grazing rate ( $g$ ) is limited by the phytoplankton biomass using a Michaelis-Menton limiting term with  $k$  as the half saturation rate. Not all the phytoplankton consumed by the mussels is converted into mussel biomass - this depends on the assimilation efficiency ( $\gamma$ ), a value between 0 and 1. The mussels also have a natural mortality rate ( $m$ ) which is proportional to their biomass. This can be expressed mathematically as:

$$\frac{d\text{Phytoplankton}}{dt} = -g \times \text{Mussels} \times \frac{\text{Phytoplankton}}{\text{Phytoplankton} + k} + k \times \text{Phytoplankton}$$

$$\frac{d\text{Mussels}}{dt} = \gamma \times g \times \text{Mussels} \times \frac{\text{Phytoplankton}}{\text{Phytoplankton} + k} - m \times \text{Mussels}$$

The conceptual model of this example can be represented in the following way. Note that the rectangle represents a state variable; the circle represents a mathematical function; and the diamond represents a parameter.

Fig. 54: Conceptual model of mussel predation on phytoplankton



## Appendix II: Summary of policy issues in the 18 study sites of the SPICOSA project

Summary of policy issues in the 18 study sites of the SPICOSA project (Hopkins et al. 2012). All study sites had at least three ecological issues and at least two economic and social issues. (WWT=Wastewater treatment, N = nitrogen)

Table 18: Summary of policy issues in the 18 study sites of the SPICOSA project

Distribution of policy issues for each area of human influence and for each ecological, social and economic dimension					
WASTING					
ECOLOGICAL	24	ECONOMIC	16	SOCIAL	16
Pollution	6	Public Costs of WWT	6	Trans-Boundary Conflicts	3
Nitrogen Loading	5	Tourist Income	4	Ecosystem Health	2
Aquaculture	3	Costs of N-loading	2	Public Costs of WWT	2
Eutrophication	3	Employment Potential	2	Recreational Benefits	2
Transparency	3	Fishery Income	1	Seafood Contamination	2
Urban/Storm Runoff	3	Habitat Conservation	1	Tourist Employment	2
Harmful Algae	1			Directives	1
				Public Costs of N-loading	1
				User Conflicts	1
HARVESTING					
ECOLOGICAL	18	ECONOMIC	12	SOCIAL	12
Fish Population	4	Fishery Income	5	Ecosystem Health	3
Aquaculture Shellfish	3	Habitat Conservation	2	Habitat Conservation	2
Fishing Practices	3	Public Costs of WWT	2	Public Costs of N-loading	2
Benthic Habitat	2	Costs of N-loading	1	Public Costs of WWT	2
Nutrient Loading	2	Public Costs of WWT	1	Shore Property Values	1
Harmful Algae	1	Tourist Income	1	User Conflicts	1
Pollution	1			Seafood Contamination	1
Transparency	1				
Storm Runoff	1				
MODIFYING					
ECOLOGICAL	12	ECONOMIC	8	SOCIAL	8
Ecosystem Health	3	Agricultural Income	2	Recreational Benefits	3
Employment	2	Costs of N-loading	2	User Conflicts	3
User Conflicts	1	Employment Potential	2	Directives	1
Habitat Conservation	1	Freshwater Scarcity	1	Trans-boundary Conflicts	1
Seafood Contamination	1	Costs of WWT	1		
Cultural Values	1				
Property Values	1				
Recreation Potential	1				

Appendix III: Inputs for SPICOSA model, units, and source

Table 19: Inputs for SPICOSA model, units, and source

Category	Variable	Units	Value / Duration of time series / Scenario options	Delta T	Source
Meteorological	Solar intensity	cal cm <sup>-2</sup> h <sup>-1</sup>	1 year time series	Hourly value for each month	Villarrubia et al. (1980)
	Precipitation	mm	4 year time series	Day	I'Observatori Fabra
	Air temperature	°C	4 year time series	Day	I'Observatori Fabra
	Sea temperature	°C	1 year time series	Month	Puertos del Estado, Spain
	Wave height	metres	4 year time series	Day	Puertos del Estado, Spain
	Wave period	seconds	4 year time series	Day	Puertos del Estado, Spain
	Wind direction	0°-360°	4 year time series	Day	I'Observatori Fabra
	Wind velocity	ms <sup>-1</sup>	4 year time series	Day	I'Observatori Fabra
	Capacity of storm collectors	m <sup>3</sup>	0 / 5.2 / 6.9 / 7.2 / 14.9 (x10 <sup>5</sup> ) (scenarios)	constant	CLABSA (sewer authority)
	CSO bacteria (faecal coliforms)	cfu 100 mL <sup>-1</sup>	1 x 10 <sup>5</sup>	constant	Metcalf & Eddy (1991)
UWWT	Direct discharge of sewer water into coastal water	%	0 / 0.25 / 0.50 / 0.75 / 1.0 (scenarios)	constant	—
	Size of catchment area	m <sup>2</sup>	3.8 x 10 <sup>7</sup>	constant	Estimated
	UWWT bacteria (faecal coliforms)	cfu 100 mL <sup>-1</sup>	0 / 3 / 10 (x10 <sup>6</sup> ) (scenarios)	constant	Metcalf & Eddy (1991)
River	UWWT outflow of wastewater	m <sup>3</sup> s <sup>-1</sup>	0 / 4.17 / 6.255 / 8.34 (scenarios)	constant	ACA (local water authority)
	River bacteria (faecal coliforms)	cfu 100 mL <sup>-1</sup>	2.5 x 10 <sup>4</sup>	constant	Huertas et al. (2006)
	Flow of river	m <sup>3</sup> s <sup>-1</sup>	4 year time series	Day	ACA (local water authority)

Table 19 continued: Inputs for SPICOSA model, units, and source

Category	Variable	Units	Value / Duration of time series / Scenario options	Delta T	Source
Beach water	Volume of each beach	m <sup>3</sup>	4.88 x 10 <sup>6</sup>	constant	Estimated
	Suspended solid settling factor (Andrea doria)	—	3.1	constant	Calculated with optimizer
	Suspended solid settling factor (Hospital del mar)	—	2.5	constant	Calculated with optimizer
	Suspended solid settling factor (Nova Icaria)	—	4.8	constant	Calculated with optimizer
	Suspended solid settling factor (Bogatell)	—	4.5	constant	Calculated with optimizer
	Suspended solid settling factor (Mar bella)	—	4.3	constant	Calculated with optimizer
	Suspended solid settling factor (Nova mar bella)	—	4.3	constant	Calculated with optimizer
	Suspended solid wind dispersion factor parameter	—	1.53	constant	Calculated with optimizer
	Acceleration due to gravity (g)	ms <sup>-2</sup>	9.81	constant	Soulsby (1997)
	Density of sediment grains	kg m <sup>-3</sup>	2650	constant	Soulsby (1997)
	Dynamic viscosity of seawater	N s m <sup>-2</sup>	0.0014	constant	Soulsby (1997)
	Density of saltwater	kg m <sup>-3</sup>	1027	constant	Soulsby (1997)
	Faecal coliforms wind dispersion factor parameter (Andrea doria)	—	0.37	constant	Calculated with optimizer
	Faecal coliforms wind dispersion factor parameter (Hosp del mar)	—	1.69	constant	Calculated with optimizer
	Faecal coliforms wind dispersion factor parameter (Nova icaria)	—	2.84	constant	Calculated with optimizer
	Faecal coliforms wind dispersion factor parameter (Bogatell)	—	3.91	constant	Calculated with optimizer
	Faecal coliforms wind dispersion factor parameter (Mar bella)	—	3.81	constant	Calculated with optimizer
	Faecal coliforms wind dispersion factor parameter (Nova mar bella)	—	3.83	constant	Calculated with optimizer
	Maximum allowable faecal coliforms (bathing water)	cfu 100 mL <sup>-1</sup>	2000	constant	Bathing water directive (76/160/EEC)

Table 19 continued: Inputs for SPICOSA model, units, and source

Category	Variable	Units	Value / Duration of time series / Scenario options	Delta T	Source
Beach users	Predisposition factor (D) - Monday	—	0	constant	Guillén et al. (2008)
	Predisposition factor (D) - Tuesday	—	0.04	constant	Guillén et al. (2008)
	Predisposition factor (D) - Wednesday	—	0.11	constant	Guillén et al. (2008)
	Predisposition factor (D) - Thursday	—	0.22	constant	Guillén et al. (2008)
	Predisposition factor (D) - Friday	—	0.275	constant	Guillén et al. (2008)
	Predisposition factor (D) - Saturday	—	0.615	constant	Guillén et al. (2008)
	Predisposition factor (D) - Sunday	—	1	constant	Guillén et al. (2008)
	Predisposition factor (M) - January	—	0.005	constant	Guillén et al. (2008)
	Predisposition factor (M) - February	—	0.005	constant	Guillén et al. (2008)
	Predisposition factor (M) - March	—	0.12	constant	Guillén et al. (2008)
	Predisposition factor (M) - April	—	0.41	constant	Guillén et al. (2008)
	Predisposition factor (M) - May	—	0.41	constant	Guillén et al. (2008)
	Predisposition factor (M) - June	—	0.845	constant	Guillén et al. (2008)
	Predisposition factor (M) - July	—	1	constant	Guillén et al. (2008)
	Predisposition factor (M) - August	—	0.91	constant	Guillén et al. (2008)
	Predisposition factor (M) - September	—	0.07	constant	Guillén et al. (2008)
	Predisposition factor (M) - October	—	0.007	constant	Guillén et al. (2008)
	Predisposition factor (M) - November	—	0.008	constant	Guillén et al. (2008)
	Predisposition factor (M) - December	—	0.005	constant	Guillén et al. (2008)
	Recreational appeal affected by suspended solids	—	—	0 / 0.625 / 1.25 / 1.875 / 2.5 (x10 <sup>-5</sup> ) (scenarios)	constant
Recreational appeal affected by faecal coliforms	—	—	0 / 1.25 / 2.5 / 3.75 / 5 (x10 <sup>-6</sup> ) (scenarios)	constant	Estimated
Recreational appeal affected by over-saturation of users	—	—	0 / 2.5 / 5 / 7.5 / 10 (x10 <sup>-6</sup> ) (scenarios)	constant	Estimated
Recreational appeal affected by "good" water status and under-saturation	—	—	0 / 2.5 / 5 / 7.5 / 10 (x10 <sup>-8</sup> ) (scenarios)	constant	Estimated
Length of beach - Andrea doria	m	450		constant	GIS
Length of beach - Hospital del mar	m	400		constant	GIS
Length of beach - Nova icaria	m	400		constant	GIS
Length of beach - Bogatell	m	600		constant	GIS
Length of beach - Mar bella	m	500		constant	GIS
Length of beach - Nova mar bella	m	400		constant	GIS

Table 19 continued: Inputs for SPICOSA model, units, and source

Category	Variable	Units	Value / Duration of time series / Scenario options	Delta T	Source	
Economic sub-model	Percentage of bars/restaurant clients from beach	%	0.05	constant	Estimated during survey	
	Expenses per customer (restaurant)	€	12	constant	Estimated during survey	
	Expenses per customer (restaurant-bar)	€	8	constant	Estimated during survey	
	Expenses per customer (bar)	€	6	constant	Estimated during survey	
	Number of restaurant seats - Andea doria	seats	650	constant	Estimated during survey	
	Number of restaurant-bar seats - Andea doria	seats	300	constant	Estimated during survey	
	Number of bar seats - Andea doria	seats	200	constant	Estimated during survey	
	Number of restaurant seats - Hospital del mar	seats	350	constant	Estimated during survey	
	Number of restaurant-bar seats - Hospital del mar	seats	300	constant	Estimated during survey	
	Number of bar seats - Hospital del mar	seats	200	constant	Estimated during survey	
	Number of restaurant seats - Nova icaria	seats	1600	constant	Estimated during survey	
	Number of restaurant-bar seats - Nova icaria	seats	400	constant	Estimated during survey	
	Number of restaurant seats - Bogatell	seats	300	constant	Estimated during survey	
	Number of bar seats - Bogatell	seats	200	constant	Estimated during survey	
	Number of restaurant seats - Mar bella	seats	125	constant	Estimated during survey	
	Number of restaurant seats - Nova mar bella	seats	125	constant	Estimated during survey	
	Travel-cost method	Percentage of beach users from Barcelona	%	0.794	constant	Barcelona council (Parcs i jardins)
		Percentage of beach users from AMB	%	0.093	constant	Barcelona council (Parcs i jardins)
		Percentage of beach users from Catalonia	%	0.081	constant	Barcelona council (Parcs i jardins)
Percentage of beach users from Spain		%	0.031	constant	Barcelona council (Parcs i jardins)	
Residents in Barcelona		individuals (x 10 <sup>3</sup> )	1595.11	constant	IDESCAT	
Residents in AMB		individuals (x 10 <sup>3</sup> )	1617.93	constant	IDESCAT	
Residents in Catalonia		individuals (x 10 <sup>3</sup> )	3782.16	constant	IDESCAT	
Residents in Spain		individuals (x 10 <sup>3</sup> )	37113.32	constant	INE	
Travel costs for beach users from Barcelona		€	5	constant	estimated	
Travel costs for beach users from AMB		€	15	constant	estimated	
Travel costs for beach users from Catalonia		€	100	constant	estimated	
Travel costs for beach users from Spain	€	200	constant	estimated		



Appendix IV: Scenario options of SPICOSA model

Table 20: Scenario options of SPICOSA model

Category	Variable	Units	Values	Name of scenario in model	Source
CSO	Capacity of storm collectors	m <sup>3</sup>	0 / 5.2 / 6.9 / 7.2 / 14.9 (x10 <sup>5</sup> )	none / current / constructing / confirmed / planned	CLABSA (sewer authority)
	Direct discharge of sewer water into coastal water	%	0 / 0.25 / 0.50 / 0.75 / 1.0	0% / 25% / 50% / 75% / 100%	Estimated
UWWT	UWWT bacteria (faecal coliforms)	cfu 100 mL <sup>-1</sup>	0 / 3 / 10 (x10 <sup>6</sup> )	zero / treated / untreated	Metcalf & Eddy (1991)
	UWWT outflow of waste water	m <sup>3</sup>	0 / 4.17 / 6.255 / 8.34	zero / current / 50% increase / 100% increase	ACA (local water authority)
Beach user	Recreational appeal affected by suspended solids	—	0 / 0.625 / 1.25 / 1.875 / 2.5 (x10 <sup>-5</sup> )	none / low / medium / high / very high	Estimated
	Recreational appeal affected by faecal coliforms	—	0 / 1.25 / 2.5 / 3.75 / 5 (x10 <sup>-6</sup> )	none / low / medium / high / very high	Estimated
	Recreational appeal affected by over-saturation of users	—	0 / 2.5 / 5 / 7.5 / 10 (x10 <sup>-6</sup> )	none / low / medium / high / very high	Estimated
	Recreational appeal affected by "ok" water status and under-	—	0 / 2.5 / 5 / 7.5 / 10 (x10 <sup>-8</sup> )	none / low / medium / high / very high	Estimated

Appendix V: Definition of symbols, and units for SPICOSA model

Table 21: Definition of symbols, and units for *Principal drivers sub-model* (SPICOSA)

<b>Symbol</b>	<b>Definition</b>	<b>Units</b>
$P$	Precipitation (rainfall)	$\text{mm m}^{-2} \text{day}^{-1}$
$B$	Drainage basin area	$\text{m}^2$
$D$	Direct discharge of sewer water	%
$W_d$	CSO water released directly to beaches	$\text{m}^3 \text{day}^{-1}$
$W_c$	CSO water entering stormwater collectors	$\text{m}^3 \text{day}^{-1}$
$W_t$	Total CSO released to beaches	$\text{m}^3 \text{day}^{-1}$
$C$	Capacity of stormwater collectors	$\text{m}^3$

Table 22: Definition of symbols, and units for Beach water clarity sub-model (SPICOSA)

<b>Symbol</b>	<b>Definition</b>	<b>Units</b>
$S_T$	Suspended solids in beach water	$\text{mg L}^{-1}$
$S_C$	Suspended solids in CSO	$\text{mg L}^{-1}$
$S_R$	Suspended solids in river	$\text{mg L}^{-1}$
$S_W$	Suspended solids caused by waves	$\text{mg L}^{-1}$
$S_s$	Suspended solid settling factor	$\text{day}^{-1}$
$S_Q$	Suspended solid wind dispersion factor	$\text{day}^{-1}$
$S_{Qr}$	Suspended solid wind dispersion factor parameter	—
$W_t$	CSO water outflow to beaches	$\text{m}^3 \text{day}^{-1}$
$F_r$	Flow of river	$\text{m}^3 \text{s}^{-1}$
$V$	Volume of beach water	$\text{m}^3$
$R_w$	River wind function	%
$Q_d$	Wind direction	$0^\circ\text{-}360^\circ$
$Q_v$	Wind velocity	$\text{ms}^{-1}$

Table 23: Definition of symbols, and units for Beach water bacteria sub-model (SPICOSA)

<b>Symbol</b>	<b>Definition</b>	<b>Units</b>
$B_T$	Faecal coliforms in beach water	cfu 100mL <sup>-1</sup>
$B_C$	Faecal coliforms from CSO (to beach water)	cfu 100mL <sup>-1</sup>
$B_{Cr}$	Faecal coliform conc. in CSO	cfu 100mL <sup>-1</sup>
$B_R$	Faecal coliforms from river (to beach water)	cfu 100mL <sup>-1</sup>
$B_{Rr}$	Faecal coliforms concentration in river	cfu 100mL <sup>-1</sup>
$B_W$	Faecal coliforms from WWTP outflow (to beach water)	cfu 100mL <sup>-1</sup>
$B_d$	Faecal coliforms decay rate	day <sup>-1</sup>
$B_Q$	Faecal coliforms wind dispersion factor	day <sup>-1</sup>
$B_{Qr}$	Faecal coliforms wind dispersion factor parameter	—
$W_t$	Volume of CSO water outflow to beaches	m <sup>3</sup> day <sup>-1</sup>
$F_R$	Flow of river	m <sup>3</sup> s <sup>-1</sup>
$F_W$	Outflow of WWTP	m <sup>3</sup> s <sup>-1</sup>
$V$	Volume of beach water	m <sup>3</sup>
$R_w$	River wind function	%
$Q_d$	Wind direction	0°-360°
$Q_v$	Wind velocity	ms <sup>-1</sup>
$k_l$	Bacteria decay (light)	h <sup>-1</sup>
$kd$	Bacteria decay (dark)	h <sup>-1</sup>
$I$	Solar intensity	cal cm <sup>-2</sup> h <sup>-1</sup>
$P$	Precipitation (rainfall)	mm m <sup>-2</sup> day <sup>-1</sup>
$t$	Sea temperature	°C

Table 24: Definition of symbols, and units for *Beach users sub-model* (SPICOSA)

<b>Symbol</b>	<b>Definition</b>	<b>Units</b>
$P$	Precipitation (rainfall)	$\text{mm m}^{-2} \text{day}^{-1}$
$Q_v$	Wind velocity	$\text{ms}^{-1}$
$T$	Air temperature	$^{\circ}\text{C}$
$D$	Predisposition factor (Day)	—
$M$	Predisposition factor (Month)	—
$N$	Number of beach users (Guillén model)	individuals
$L$	Length of beach	m
$A$	Recreational appeal of beach	—
$N_E$	Expected number of beach users (adjusted for rec. Appeal))	individuals
$A_S$	Recreational appeal affected by suspended solids	—
$A_B$	Recreational appeal affected by faecal coliforms	—
$A_U$	Recreational appeal affected by over-saturation of users	—
$A_G$	Recreational appeal affected by "good" water status and under-satur	—
$S_T$	Suspended solids in beach water	$\text{mg L}^{-1}$
$B_T$	Faecal coliforms in beach water	$\text{cfu } 100 \text{mL}^{-1}$

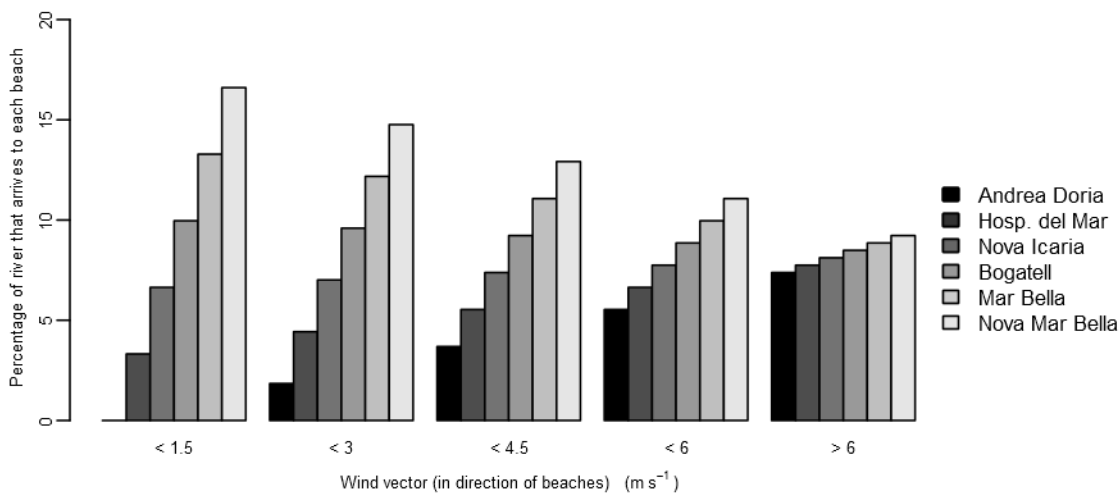
Table 25: Definition of symbols, and units for *Economic evaluation sub-model* (SPICOSA)

<b>Symbol</b>	<b>Definition</b>	<b>Units</b>
$N_E$	Expected number of beach users (adjusted for rec. Appeal))	individuals
$T$	Seat turnover (restaurants, restaurant-bars, bars)	clients served / max. occupancy
$O$	Maximum occupancy (restaurants, restaurant-bars, bars)	seats
$P$	Average expense per person (restaurants, restaurant-bars, bars)	€
$N_b$	Percentage of restaurants/restaurant-bars/bars clients from beach	%
$i$	index of restaurants;bar-restaurants;bars	—
$R$	Revenues (restaurants, restaurant-bars, bars)	€ day <sup>-1</sup>
$x$	Travel cost per person	€
$y$	The visit rate (Travel cost method)	—

## Appendix VI: River wind function (SPICOSA)

The outflow of the river can potentially arrive to the beaches depending on the direction of the wind. The river is situated to the northeast of the beaches (with the coastline running approximately from northeast to southwest). So if the wind direction ( $Q_d$ ) is between  $0^\circ$  and  $90^\circ$  then a certain proportion of the river will arrive to the beaches. There was no available model to calculate the exact percentage of river water that would arrive to each beach so images of the coastline were examined and compared to the wind direction and velocity for that day. From the images, there was a tendency for the river plume to arrive further down the coast to the furthest beach (Andrea Doria) when the wind velocity was greatest. When the wind velocity was low the nearest beaches to the river would receive the majority of the river plume. From analysing the images, the maximum total percentage of the river that can arrive to the beaches was set to 50%. It is likely that current velocity and direction would also influence the direction and dispersion of the river into the sea. I acknowledge that this function is a rough estimate and should be improved in future iterations of the model. This function is used in both the Beach water clarity and Beach water bacteria sub-models.

Fig. 56: River wind function (SPICOSA)



## Appendix VII: Calculation of suspended solid caused by waves (SPICOSA)

Calculation of suspended solid caused by waves ( $c_{mZ}$ ). All the equations are taken from Soulsby (1997).

Input variables are: wave period ( $T$ ); depth ( $D$ ); wave height ( $H$ ); grain size ( $d$ ); and height about seabed ( $z$ )

Parameters:

$$g = 9.81 \quad \text{Acceleration due to gravity (m s}^{-2}\text{)}$$

$$\rho_s = 2650 \quad \text{Density of sediment grains (kg m}^{-3}\text{)}$$

$$\mu = 0.0014 \quad \text{Dynamic viscosity of seawater (N s m}^{-2}\text{)}$$

$$\rho = 1027 \quad \text{Density of saltwater (kg m}^{-3}\text{) – (Fixed for this model)}$$

Equations:

Padé approximation to solve wavelength:

$$G = \left( \left( \frac{2\pi}{T} \right)^2 \right) \frac{D}{g}$$

$$F = G + \frac{1}{1 + 0.6522G + 0.4622G^2 + 0.0864G^4 + 0.0675 G^5}$$

$$L = T \left( \frac{gD}{F} \right)^{0.5}$$

Ratio of densities of grain and water:

$$s = \frac{\rho_s}{\rho}$$

Kinematic viscosity of water:

$$\nu = \frac{\mu}{\rho}$$

Amplitude of wave orbital velocity:

$$u_w = \frac{(\pi H)}{T \sinh \left( d \frac{2\pi}{L} \right)}$$

Orbital amplitude:

$$A = \frac{u_W T}{2\pi}$$

Dimensionless grain size:

$$D_* = \left( \frac{g(s-1)}{\nu^2} \right)^{1/3} d$$

Threshold shields parameter:

$$\theta_{cr} = \frac{0.30}{1 + (1.2d_*)} + 0.055(1 - e^{-0.02d_*})$$

Grain settling velocity:

$$w_s = \frac{\nu}{d} \sqrt{(10.36^2 + 1.049D_*^3)} - 10.36$$

Rough-bed wave friction factor:

$$r = \frac{u_W T}{5\pi d}$$

$$f_{wr} = 0.00251 e^{5.21r^{-0.19}}$$

Wave friction factor (note that the formula requires a value for  $f_w$  for which  $f_{wr}$  has been used – i.e. it is assumed that the flow is rough turbulent).

$$\tau_{ws} = \frac{1}{2} \rho f_{wr} u_W^2$$

Skin-friction Shields parameter:

$$\theta_{ws} = \frac{\tau_{ws}}{g(\rho_s - \rho)d}$$

Ripple wavelength ( $\lambda$ ) and height ( $\eta$ ):

$$\theta_B = 1.8 \theta_{cr} \left( \frac{D_*^{1.5}}{4} \right)^{0.6}$$

$$(1) \theta_{ws} \leq \theta_{cr} \quad \Rightarrow \quad \eta = 0$$

$$\lambda = 0$$

$$(2) \theta_{cr} < \theta_{ws} \ \& \ \theta_{ws} \leq \theta_B \quad \Rightarrow \quad \eta = 0.22 \left( \frac{\theta_{ws}}{\theta_{cr}} \right)^{-0.16} A$$

$$\lambda = \frac{\eta}{0.16 \left( \frac{\theta_{ws}}{\theta_{cr}} \right)^{-0.04}}$$

$$(3) \theta_{ws} > \theta_B \quad \Rightarrow \eta = 0.48 \left( \frac{D_*^{1.5}}{4} \right)^{0.8} \left( \frac{\theta_{ws}}{\theta_{cr}} \right)^{-1.5} A$$

$$\lambda = \frac{\eta}{0.28 \left( \left( \frac{D_*^{1.5}}{4} \right)^{0.6} \left( \frac{\theta_{ws}}{\theta_{cr}} \right)^{-1} \right)}$$

Decay length scale ( $l$ ):

$$(1) \left( \frac{u_W}{w_s} \right) < 18 \quad \Rightarrow l = 0.075 \left( \frac{u_W}{w_s} \right) \eta$$

$$(2) \left( \frac{u_W}{w_s} \right) \geq 18 \quad \Rightarrow l = 1.4 \eta$$

Reference concentration:

$$\theta_r = \frac{f_{wr} u_W^2}{2(s-1)g d \left( 1 - \pi \left( \frac{\eta}{\lambda} \right) \right)^2}$$

Sediment concentration at height  $z$ :

$$c_z = 0.005 \theta_r^3 e^{-\frac{z}{l}}$$

Sediment concentration if threshold exceeded:

$$(1) d < 0.0005 \quad \Rightarrow u_{wcr} = (0.118g(s-1))^{2/3} d^{1/3} T^{1/3}$$

$$(2) d \geq 0.0005 \quad \Rightarrow u_{wcr} = (1.09g(s-1))^{4/7} d^{3/7} T^{1/3}$$

Mass per volume ( $\text{kg m}^{-3}$ )

$$(1) u_W < u_{wcr} \quad \Rightarrow c_{mz} = 0$$

$$(2) u_W > u_{wcr} \quad \Rightarrow c_{mz} = c_z \rho_s$$



Appendix VIII: Solar intensity for Barcelona (SPICOSA)

Solar intensity for Barcelona ( $\text{cal cm}^{-2} \text{h}^{-1}$ ) (Villarrubia et al. 1980)

This table is used in the Beach water bacteria model to calculate the decay of bacteria.

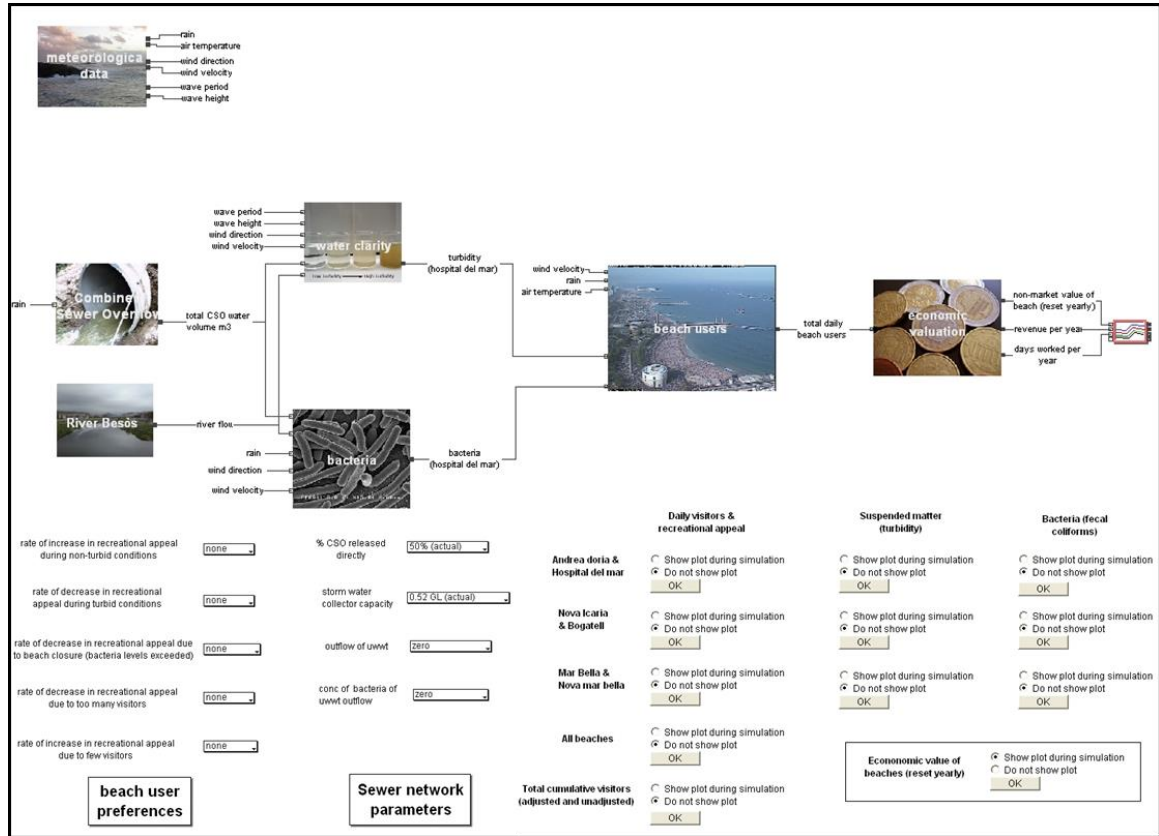
Table 26: Solar intensity per hour and month for Barcelona (SPICOSA)

Month	Solar time																								
	0	1	2	3	4	5	6	7	8	9	10	11	12	13	14	15	16	17	18	19	20	21	22	23	
Jan	0	0	0	0	0	0	0	2	11	21	28	32	31	28	20	10	2	0	0	0	0	0	0	0	0
Feb	0	0	0	0	0	0	0	8	18	26	33	36	37	31	23	14	5	0	0	0	0	0	0	0	0
Mar	0	0	0	0	0	0	2	9	20	31	40	43	44	38	34	23	13	4	0	0	0	0	0	0	0
Apr	0	0	0	0	0	1	9	21	33	45	52	57	57	52	42	32	20	9	1	0	0	0	0	0	0
May	0	0	0	0	0	4	14	25	38	48	55	62	62	57	49	37	26	13	4	0	0	0	0	0	0
June	0	0	0	0	1	6	17	28	40	48	57	59	59	56	49	38	27	15	5	0	0	0	0	0	0
July	0	0	0	0	0	6	17	28	40	51	60	65	65	61	54	43	30	16	5	0	0	0	0	0	0
Aug	0	0	0	0	0	3	13	25	38	49	58	63	62	57	49	38	25	11	2	0	0	0	0	0	0
Sep	0	0	0	0	0	0	5	15	27	36	42	48	48	44	36	26	15	4	0	0	0	0	0	0	0
Oct	0	0	0	0	0	0	1	8	18	27	35	39	38	35	28	18	8	1	0	0	0	0	0	0	0
Nov	0	0	0	0	0	0	0	3	10	19	25	29	28	24	18	10	2	0	0	0	0	0	0	0	0
Dec	0	0	0	0	0	0	0	1	7	16	22	25	25	22	16	7	1	0	0	0	0	0	0	0	0

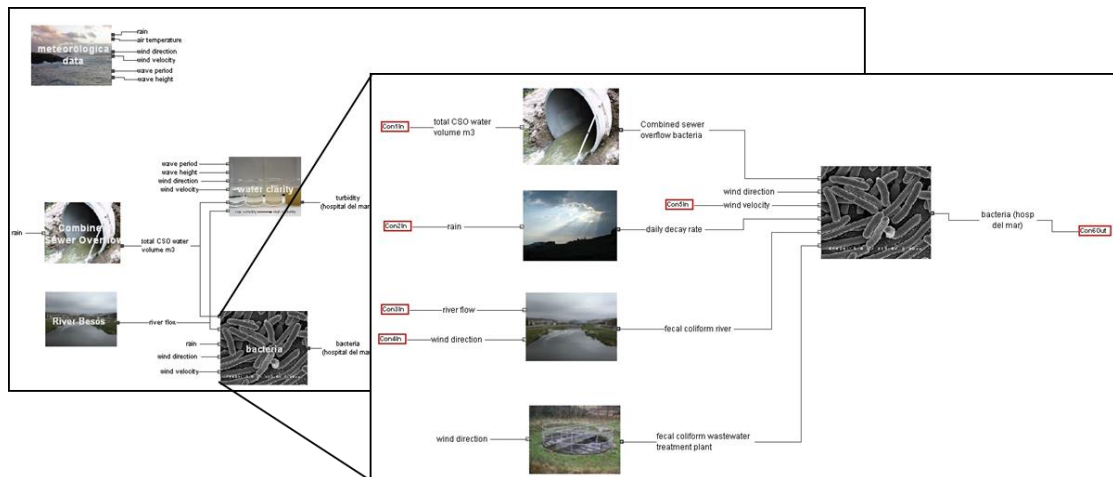
Appendix IX: Screenshots of the model presented to stakeholders (SPICOSA)

The user can select which scenarios to run as well as select which output results to view

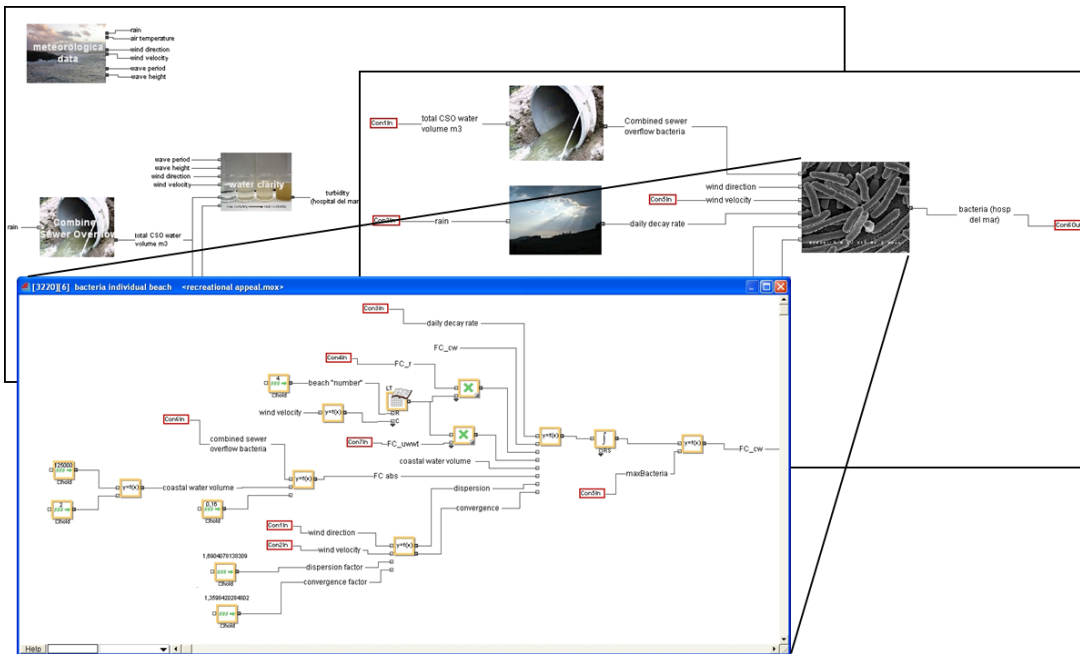
Fig. 57: Example screenshots of model in ExtendSim (SPICOSA)



The model is hierarchical so that from the initial view the user can understand the system as a whole. By opening sub-models or blocks, a lower hierarchical level is shown to display further details of the model.



The user can keep opening lower levels until they arrive at the programming code.



Appendix X: Definition of symbols, and units for fisheries sub-model (VECTORS)

Table 27: Definition of symbols, and units for fisheries sub-model (VECTORS)

Symbol	Definition	Units
$L_{\infty}$	Maximum length (Von Bertalanffy growth model)	cm
$\bar{N}$	Mean number of individuals	individual
$t_0$	Age at length 0 (Von Bertalanffy growth model)	year
$\bar{w}$	Mean individual weight	g
$\bar{B}$	Mean biomass	ton
$a$	Age	month
$A$	Parameter in length-weight equation	—
$annualC$	Annual cost in running vessel excluding daily costs	€/year
$B$	Parameter in length-weight equation	—
$C$	Catch	ton/month
$c1$	Percentage paid to fish market for sale of catch	%
$c3$	Percentage of profits given to crew (“ <i>monte menor</i> ”)	%
$c6$	Public debt interest rate	%
$Co$	Costs	€/month
$Co1$	Trade costs	€/month
$Co2$	Daily costs	€/month
$Co3$	Labour costs	€/month
$Co4$	Compulsory costs (fixed)	€/month
$Co5$	Maintenance costs (variable)	€/month
$Co6$	Opportunity costs	€/month
$Cy$	Catch	ton/year
$F$	Fishing mortality rate	year <sup>-1</sup>
$fc$	Fuel consumption	litre/year
$fp$	Fuel price	€/litre
$G$	Proportion of mature fish	%
$i$	Species index	—
$I$	Total number of species	—
$ice$	Daily consumption of ice	€/day
$J$	Predation of by <i>P. noctiluca</i> (see Jellyfish sub-model)	individual
$k$	Growth rate (Von Bertalanffy growth model)	year <sup>-1</sup>
$K$	Capital of vessel(s)	€
$l$	Length	cm
$M$	Natural mortality rate	year <sup>-1</sup>
$m$	Maximum age	month
$N$	Population of species	individual
$NFD$	Number of fishing days worked in a year	days
$oDC$	Other daily direct costs (excluding ice and fuel) e.g. repairs, food for crew	€/year
$p$	Price of species	€/kg
$P$	Total monthly revenues	€/month
$percFC$	Percentage of annual costs which are compulsory costs	%
$percVC$	Percentage of annual costs which are maintenance costs	%
$Py$	Total yearly revenues	€/year
$S$	Fecundity of species individual	Larvae/year

Table 27 continued: Definition of symbols, and units for fisheries sub-model (VECTORS)

<b>Symbol</b>	<b>Definition</b>	<b>Units</b>
$s$	Fecundity modifier (proportion for given month)	—
$SSB$	Spawning stock biomass	ton
$SSBy$	Spawning stock biomass	ton
$t$	Time	month
$T$	Time	year
$v$	Zone index	—
$V$	Total number of zones	—
$Z$	Total mortality rate	month <sup>-1</sup>

Appendix XI: Input values for fisheries sub-model (VECTORS)

Biological fish-growth parameters for sardine (*Sardina pilchardus*) and anchovy (*Engraulis encrasicolus*) used in the von Bertalanffy growth model and the length-weight relation equation are shown in Table 28. They were calculated by averaging the values from 2002 to 2009 for the Northern Spain geographical sub-area (GSA06) in the *Assessment of Mediterranean Stocks* written by the *Scientific, Technical and Economic Committee for Fisheries* (Cardinale et al. 2010).

Table 28: Biological fish-growth parameters for sardine and anchovy (VECTORS)

Parameter	Anchovy	Sardine
$m$ (Maximum age in months)	47	71
$A$	0.003413	0.004720
$B$	3.260	3.202
$L_{\infty}$	19	23
$k$	0.363	0.314
$t_0$	-2.046	-2.383

Maturity, natural mortality, fishing mortality were also averaged from 2002 to 2009 for GSA06 (Cardinale et al. 2010), and were then smoothed from a yearly value to a monthly value as shown in Table 31 (anchovy) and Table 32 (sardine) with the exception of larva (Age 0) natural mortality whose calculation is described below.

Initial population of each age-group for each species for each zone is based on the estimations from Cardinale et al. (2010) for the whole of GSA06. The number of catches by species and zone was calculated as an average from 2002 to 2009 from officially recorded data from the fishing ports (IDESCAT 2010) and converted to a percentage of catches for the whole of GSA06 for 2002-2009 as shown in Table 29. (Note that GSA06 includes not only Catalonia but most of the Valencian coast too). These percentages were then multiplied by the population levels for each age-group from Cardinale et al. (2010). The initial population for each age-group for each zone is shown in Table 31 (anchovy) and Table 32 (sardine).

Table 29: Percent of catches of GSA06 in each zone by species (VECTORS)

	Anchovy	Sardine
Tarragona	16.6	15.9
Barcelona	15.0	13.9
Girona	26.6	13.8

An initial estimate for yearly anchovy fecundity was taken from the literature for North Aegean Sea (Eastern Mediterranean) (Mantzouni et al. 2007) which is based on a function of probability of individual survival to the spawning season, maternity and the summer survival of the spawners. It is not the same rate as we need for our model but it gives us a pattern of fecundity across age-groups - Fecundity is approximately half when aged 0 and 3 years in comparison to aged 1 and 2 as shown in Table 30 (Mantzouni et al. 2007). There was no available age-based sardine fecundity rate in the literature, so a lifetime fecundity rate was adapted from Froese and Pauly (2014) to a yearly age-group based rate.

These fecundity rates were then multiplied by a factor (the same used for each age-group) to reproduce concentration levels of larvae that are normally found in the Catalan sea (García and Palomera 1996, Olivar et al. 2003, Sabatés et al. 2007, 2013, Martín et al. 2008). (Remember that this fecundity rate ( $S$ ) is then multiplied by a fecundity modifier ( $s$ ) so that anchovy only reproduce in the summer months, and sardines only in the winter months).

The larva (Age 0) natural mortality was then adjusted to create a stable population output. The value which produces a stable output for the yearly natural mortality of anchovy is  $94 \text{ year}^{-1}$  which is similar to that found in the literature ( $0.2 \text{ day}^{-1} = 73 \text{ year}^{-1}$  (Mantzouni et al. 2007) and  $0.286 \text{ day}^{-1} = 104 \text{ year}^{-1}$  (Pertierra et al. 1997)). The value of sardine natural mortality which produces a stable population is  $87 \text{ year}^{-1}$  - similar to an analysis in the Eastern Liguria (Romanelli et al. 2002) which calculated sardine larva natural mortality as a range between  $0.109\text{--}0.362 \text{ day}^{-1} = 40\text{--}132 \text{ year}^{-1}$ .

Table 30: Fecundity rate of anchovy taken from Mantzouni et al. (2007) (VECTORS)

Age-group (years)	Fecundity rates
0	82.62
1	160.17
2	166.88
3	64.06

Table 31: Anchovy maturity, natural mortality, fishing mortality, fecundity and initial population per zone (VECTORS)

Age ( <i>a</i> )	Maturity ( <i>G</i> )	Natural mortality ( <i>M</i> )	Fishing mortality ( <i>F</i> )	Fecundity ( <i>S</i> )	Population Tarragona (N)	Population Barcelona (N)	Population Girona (N)
0	-	94.00	-	-	-	-	-
1	0.09	1.59	-	-	228971436	207909313	367325105
2	0.18	1.51	-	-	-	-	-
3	0.26	1.42	-	-	-	-	-
4	0.34	1.33	-	-	-	-	-
5	0.41	1.25	-	-	-	-	-
6	0.47	1.16	0.104	4131	-	-	-
7	0.53	1.08	0.185	4131	-	-	-
8	0.58	0.99	0.248	4131	-	-	-
9	0.63	0.90	0.299	4131	-	-	-
10	0.68	0.82	0.341	4131	-	-	-
11	0.72	0.73	0.378	4131	-	-	-
12	0.76	0.71	0.415	8009	-	-	-
13	0.79	0.67	0.455	8009	97856917	88855469	156985968
14	0.82	0.63	0.499	8009	-	-	-
15	0.84	0.60	0.550	8009	-	-	-
16	0.87	0.57	0.611	8009	-	-	-
17	0.88	0.55	0.681	8009	-	-	-
18	0.90	0.52	0.762	8009	-	-	-
19	0.91	0.50	0.855	8009	-	-	-
20	0.92	0.48	0.958	8009	-	-	-
21	0.93	0.47	1.071	8009	-	-	-
22	0.93	0.45	1.194	8009	-	-	-
23	0.93	0.43	1.325	8009	-	-	-
24	1.00	0.42	1.461	8344	-	-	-
25	1.00	0.41	1.600	8344	32546062	29552286	52211690
26	1.00	0.40	1.739	8344	-	-	-
27	1.00	0.38	1.874	8344	-	-	-
28	1.00	0.37	2.003	8344	-	-	-
29	1.00	0.36	2.119	8344	-	-	-
30	1.00	0.36	2.219	8344	-	-	-
31	1.00	0.35	2.297	8344	-	-	-
32	1.00	0.34	2.347	8344	-	-	-
33	1.00	0.33	2.363	8344	-	-	-
34	1.00	0.32	2.338	8344	-	-	-
35	1.00	0.32	2.266	8344	-	-	-
36	1.00	0.31	2.137	3253	-	-	-



Table 31 continued: Anchovy maturity, natural mortality, fishing mortality, fecundity and initial population per zone (VECTORS)

Age ( $a$ )	Maturity ( $G$ )	Natural mortality ( $M$ )	Fishing mortality ( $F$ )	Fecundity ( $S$ )	Population Tarragona (N)	Population Barcelona (N)	Population Girona (N)
37	1.00	0.30	1.945	3253	2523364	2291250	4048081
38	1.00	0.30	1.680	3253	-	-	-
39	1.00	0.29	1.334	3253	-	-	-
40	1.00	0.29	0.896	3253	-	-	-
41	1.00	0.28	0.358	3253	-	-	-
42	1.00	0.28	0.358	3253	-	-	-
43	1.00	0.27	0.358	3253	-	-	-
44	1.00	0.27	0.358	3253	-	-	-
45	1.00	0.26	0.358	3253	-	-	-
46	1.00	0.26	0.358	3253	-	-	-
47	1.00	0.25	0.358	3253	-	-	-

Table 32: Sardine maturity, natural mortality, fishing mortality, fecundity and initial population per zone (VECTORS)

Age ( $a$ )	Maturity ( $G$ )	Natural mortality ( $M$ )	Fishing mortality ( $F$ )	Fecundity ( $S$ )	Population Tarragona (N)	Population Barcelona (N)	Population Girona (N)
0	-	87.00	-	-	-	-	-
1	-	1.46	-	-	364963951	320136987	317317562
2	-	1.39	-	-	-	-	-
3	-	1.32	-	-	-	-	-
4	-	1.25	-	-	-	-	-
5	-	1.18	-	-	-	-	-
6	0.39	1.11	0.012	1819	-	-	-
7	0.44	0.97	0.050	1819	-	-	-
8	0.49	0.88	0.095	1819	-	-	-
9	0.53	0.82	0.147	1819	-	-	-
10	0.57	0.76	0.204	1819	-	-	-
11	0.61	0.72	0.266	1819	-	-	-
12	0.65	0.67	0.332	3639	-	-	-
13	0.69	0.64	0.401	3639	49589698	43498807	43115716
14	0.72	0.61	0.472	3639	-	-	-
15	0.75	0.58	0.544	3639	-	-	-
16	0.78	0.56	0.618	3639	-	-	-
17	0.81	0.54	0.691	3639	-	-	-
18	0.83	0.52	0.765	3639	-	-	-
19	0.86	0.50	0.837	3639	-	-	-
20	0.88	0.48	0.907	3639	-	-	-
21	0.90	0.47	0.976	3639	-	-	-
22	0.92	0.45	1.042	3639	-	-	-
23	0.93	0.44	1.105	3639	-	-	-
24	0.95	0.43	1.165	3639	-	-	-

Table 32 continued: Sardine maturity, natural mortality, fishing mortality, fecundity and initial population per zone (VECTORS)

Age ( <i>a</i> )	Maturity ( <i>G</i> )	Natural mortality ( <i>M</i> )	Fishing mortality ( <i>F</i> )	Fecundity ( <i>S</i> )	Population Tarragona (N)	Population Barcelona (N)	Population Girona (N)
25	0.96	0.41	1.221	3639	7744943	6793664	6733833
26	0.97	0.40	1.272	3639	-	-	-
27	0.98	0.39	1.320	3639	-	-	-
28	0.99	0.38	1.363	3639	-	-	-
29	1.00	0.38	1.401	3639	-	-	-
30	1.00	0.37	1.435	3639	-	-	-
31	1.00	0.36	1.463	3639	-	-	-
32	1.00	0.35	1.486	3639	-	-	-
33	1.00	0.34	1.504	3639	-	-	-
34	1.00	0.34	1.516	3639	-	-	-
35	1.00	0.33	1.523	3639	-	-	-
36	1.00	0.33	1.526	3639	-	-	-
37	1.00	0.32	1.523	3639	874977	767507	760748
38	1.00	0.31	1.515	3639	-	-	-
39	1.00	0.31	1.502	3639	-	-	-
40	1.00	0.30	1.485	3639	-	-	-
41	1.00	0.30	1.463	3639	-	-	-
42	1.00	0.29	1.437	3639	-	-	-
43	1.00	0.29	1.408	3639	-	-	-
44	1.00	0.28	1.375	3639	-	-	-
45	1.00	0.28	1.339	3639	-	-	-
46	1.00	0.28	1.301	3639	-	-	-
47	1.00	0.27	1.260	3639	-	-	-
48	1.00	0.27	1.218	3639	-	-	-
49	1.00	0.26	1.175	3639	212871	186725	185080
50	1.00	0.26	1.132	3639	-	-	-
51	1.00	0.26	1.088	3639	-	-	-
52	1.00	0.25	1.046	3639	-	-	-
53	1.00	0.25	1.004	3639	-	-	-
54	1.00	0.25	0.965	3639	-	-	-
55	1.00	0.25	0.943	3639	-	-	-
56	1.00	0.24	0.943	3639	-	-	-
57	1.00	0.24	0.943	3639	-	-	-
58	1.00	0.24	0.943	3639	-	-	-
59	1.00	0.23	0.943	3639	-	-	-
60	1.00	0.23	0.943	1819	-	-	-

Table 32 continued: Sardine maturity, natural mortality, fishing mortality, fecundity and initial population per zone (VECTORS)

Age ( $a$ )	Maturity ( $G$ )	Natural mortality ( $M$ )	Fishing mortality ( $F$ )	Fecundity ( $S$ )	Population Tarragona (N)	Population Barcelona (N)	Population Girona (N)
61	1.00	0.23	0.943	1819	966888	848129	840659
62	1.00	0.23	0.943	1819	-	-	-
63	1.00	0.22	0.943	1819	-	-	-
64	1.00	0.22	0.943	1819	-	-	-
65	1.00	0.22	0.943	1819	-	-	-
66	1.00	0.22	0.943	1819	-	-	-
67	1.00	0.22	0.943	1819	-	-	-
68	1.00	0.21	0.943	1819	-	-	-
69	1.00	0.21	0.943	1819	-	-	-
70	1.00	0.21	0.943	1819	-	-	-
71	1.00	0.21	0.943	1819	-	-	-

The fecundity modifier ( $s$ ) was estimated using egg and larva population data for anchovies and sardines taken from the literature (Sabatés 1990, Palomera 1992, Olivar et al. 2003) and shown in Table 33. Note that in the table the values are advanced by one month because the spawning occurs at time  $t+1$ . Therefore, for example, we would expect to see the greatest number of anchovy larvae in June, because May has the highest value (0.4).

Table 33: Fecundity modifier for anchovy and sardine (VECTORS)

Month	Anchovy	Sardine
1	-	0.05
2	-	0.03
3	-	0.02
4	0.09	0.01
5	0.4	-
6	0.34	-
7	0.1	-
8	0.04	0.02
9	0.02	0.06
10	0.01	0.4
11	-	0.33
12	-	0.08

Input data for the vessel, fleet and market parameters are shown in Table 34. The number of 12-24m purse seiners working in each zone was divided by the total for Spain and the fleet capital ( $K$ ) calculated accordingly (Anderson and Carvalho 2013).

Table 34: Vessel, fleet and market input parameters (VECTORS)

	Tarragona	Barcelona	Girona
<i>annualC</i>	280000	518000	392000
<i>c1</i>	19.5	19.5	19.5
<i>c3</i>	40	40	40
<i>c6</i>	0.7	0.7	0.7
<i>fc</i>	19200	35520	26880
<i>fp</i>	0.4	0.4	0.4
<i>ice</i>	33	33	33
<i>K</i>	5540000	10249000	7756000
<i>NFD</i>	190	190	190
<i>oDC</i>	0	0	0
<i>p (anchovy)</i>	1.62	1.62	1.62
<i>p (sardine)</i>	1.27	1.27	1.27
<i>percFC</i>	70	70	70
<i>percVC</i>	30	30	30

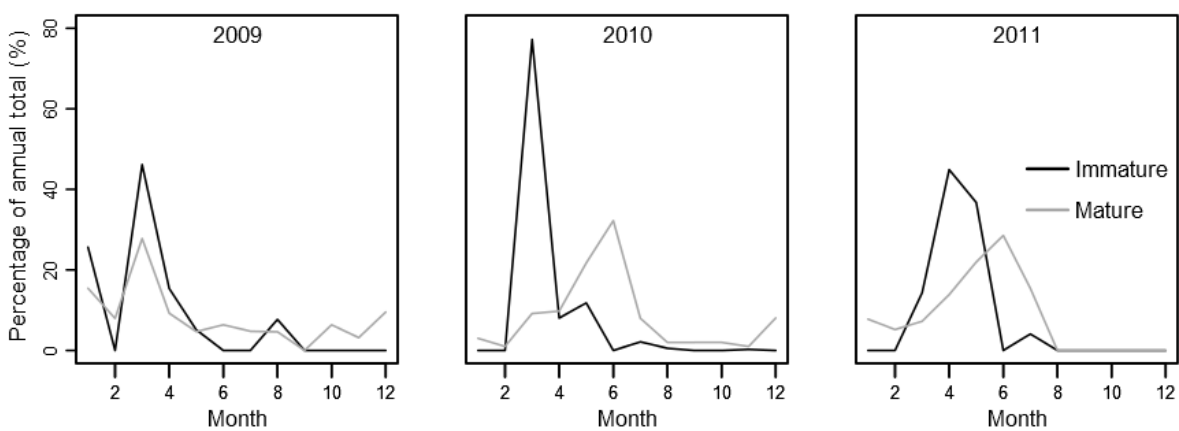
Appendix XII: Estimation of parameters for *P. noctiluca* projection matrix (VECTORS)

The size frequency distribution data for *P. noctiluca* over three years from Rosa et al. (2013) was extracted and converted into a monthly percentage of immature and mature jellyfish as shown in Table 35 and Fig. 57. (For this analysis *P. noctiluca* with a diameter larger than 40 mm are considered to be mature given that oocytes are present in the ovaries of individuals with diameter 35 mm and male gonads are mature in individuals larger than 35 mm (Rottini-Sandrini and Avian 1991))

Table 35: Percentage of immature and mature *P. noctiluca* per month (adapted from (Rosa et al. 2013)) (VECTORS)

Month	2009		2010		2011	
	Immature	Mature	Immature	Mature	Immature	Mature
1	26	15	0	3	0	8
2	0	8	0	1	0	5
3	46	28	77	9	14	7
4	15	9	8	10	45	14
5	5	5	12	22	37	22
6	0	6	0	32	0	29
7	0	5	2	8	4	15
8	8	5	1	2	0	0
9	0	0	0	2	0	0
10	0	6	0	2	0	0
11	0	3	0	1	0	0
12	0	10	0	8	0	0

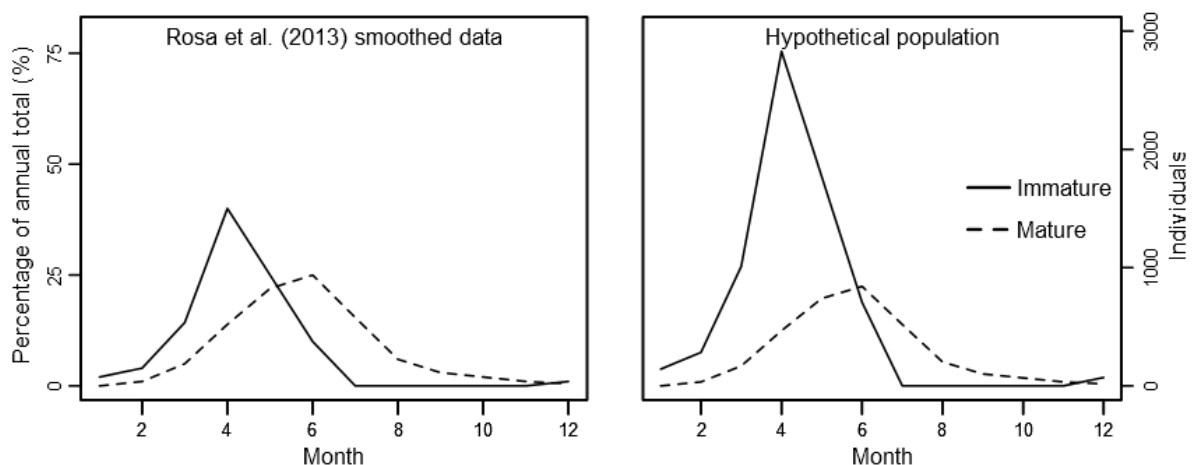
Fig. 57: Monthly immature and mature *P. noctiluca* as a percentage of annual total (adapted from Rosa et al. (2013)) (VECTORS)



In each of the three years, immature *P. noctiluca* start to appear in late winter and peak in early spring before maturing or dying. Mature *P. noctiluca* generally peak a little later, towards the end of spring although can exist in low numbers until the end of the year. The data was combined into an average of the three years, smoothed using a moving average with period 3 as shown in Fig. 58.

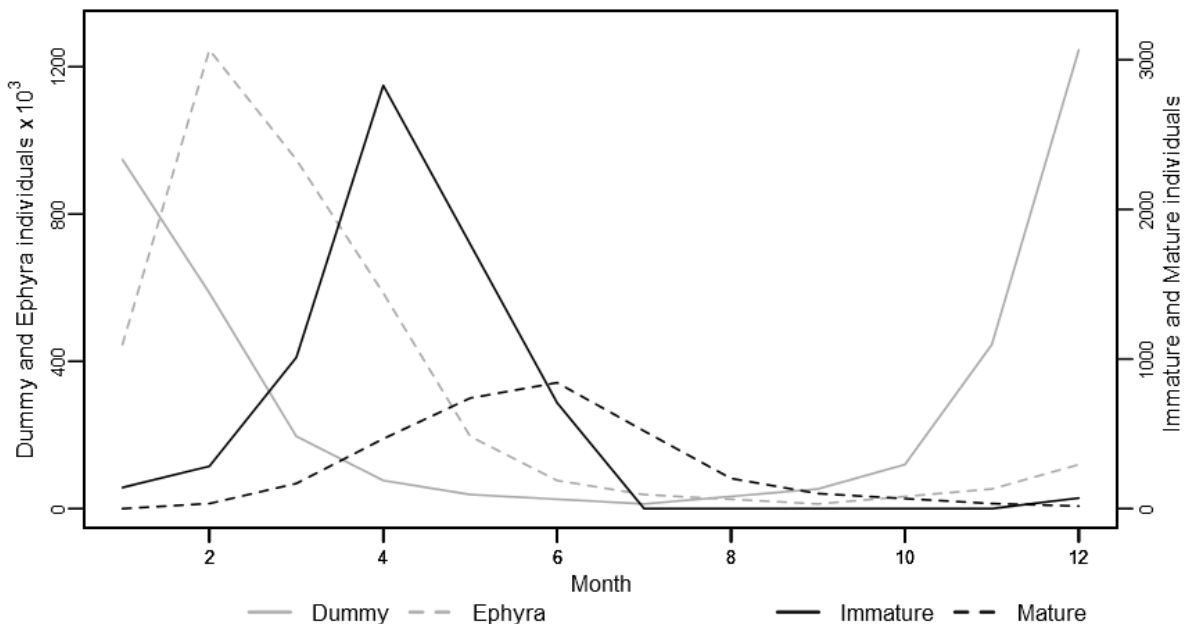
These percentages were then converted to a hypothetical population of mature and immature individuals as shown in Fig. 58. The data from Rosa et al. (2013) shows fewer immature individuals than mature individuals when aggregated over the year, probably because the immature individuals were harder to spot due to their size and possibly because they were deeper in the water column preventing clear observation. Obviously this is not a true reflection of the population size of each class as all mature individuals must first be an immature individual. However, given an average mortality rate of 0.4 (33%) per month (Malej and Malej 1992) and assuming a duration of two months for immature *P. noctiluca*, approximately 55% of immature would survive until the mature stage ( $survival = 1 - e^{-zt}$ ). Therefore we estimate that over the year there would be 55% more immature individuals than mature. The number of immature individuals was increased proportionally to the monthly observed percent extracted from Rosa et al. (2013), until over the year there were 55% more immature than mature individuals. It is important to note that when constructing a population matrix model the absolute numbers are not important, whereas the relative number of each class is necessary for correct parameterisation.

Fig. 58: Converting data taken from Rose et al. (2013) to hypothetical population (VECTORS)



There was no data from Rosa et al. (2013) regarding the abundance of ephyra. An estimate was taken from data during the FISHJELLY research campaign undertaken along the Catalan coast in June 2011 which collected both *P. noctiluca* and ephyra samples. The ratio of ephyrae to adults in the samples was approximately 378:1. Given the fact there was no better data available, the number of adults was multiplied by 378 for each month and then hastened by 2 months to reflect the duration time in the ephyra class. Similarly the dummy variable (which is a mathematical construct in place of the egg and planula stage) used the same time series as the ephyra class advanced by 2 months. It should be noted that this dummy class is not important for our analysis so the value of the population of this class is irrelevant. It is more important to capture the changing dynamics of the classes within the year.

Fig. 59: Time series data used to parameterise population matrix model (VECTORS)



This time series was then used to calculate the parameters for the projection matrix using the (inverse) regression method for time series as described in Caswell (2006). Whereas the *forward* problem (determining the future population given a population at time  $t$  and a projection matrix) is resolved with matrix multiplication, the *inverse* problem is more difficult to calculate because there are non-unique solutions – many matrix models can produce the same dynamics. For example, suppose there are two foxes alive yesterday and three foxes alive today. It is both possible (mathematically) that (1) one fox was born today and (2) 101 foxes were born today and 100 foxes also died. In order to parameterise the projection matrix which reflects reality, limitations are placed on the final selection of coefficients which are both mathematically and biologically logical.

For a time series with  $T$  time points of data and  $s$  number of life stages:  $\mathbf{n}(1)$ ,  $\mathbf{n}(2)$ , ... ,  $\mathbf{n}(T)$  , the matrix equation at row  $i$  is calculated by:

$$n_i(t + 1) = \sum_{j=1}^s a_{ij}n_j(t)$$

This can be expressed as a matrix multiplication:

$$\begin{pmatrix} n_i(2) \\ n_i(3) \\ \vdots \\ n_i(T) \end{pmatrix} = \begin{pmatrix} n_1(1) & \cdots & n_s(1) \\ n_1(2) & \cdots & n_s(2) \\ \vdots & & \vdots \\ n_1(T) & \cdots & n_s(T-1) \end{pmatrix} \begin{pmatrix} a_{i1} \\ \vdots \\ a_{is} \end{pmatrix}$$

Given that there are more observations in the time series  $n$  than there are coefficients  $a$  to estimate, this means there is no exact solution. To find a solution, we can estimate the coefficients using standard multiple linear regression techniques such as *ordinary least squares*.

For a time series  $\mathbf{n}(1)$ ,  $\mathbf{n}(2)$ , ... ,  $\mathbf{n}(T)$  , and projection matrix  $\mathbf{A}$ :

$$\mathbf{A} = \begin{bmatrix} L_1 & 0 & 0 & R_4 \\ G_1 & L_2 & 0 & 0 \\ 0 & G_2 & L_3 & 0 \\ 0 & 0 & G_3 & L_4 \end{bmatrix}$$

For any stage  $i > 1$ :

$$\begin{pmatrix} n_i(2) \\ \vdots \\ n_i(T) \end{pmatrix} = \begin{pmatrix} n_{i-1}(1) & n_i(1) \\ \vdots & \vdots \\ n_{i-1}(T-1) & n_i(T-1) \end{pmatrix} \begin{pmatrix} G_{i-1} \\ L_i \end{pmatrix}$$

Each pair of parameters ( $G_{i-1}$  and  $P_i$ ) was resolved using ordinary least squares until the projection matrix was completed with the exception of the reproduction value,  $R_4$ . Given that the estimation of each pair of parameters is independent, this could introduce unknown bias into the estimates. Despite this, the technique works well with noise-free artificial data (Caswell 2006).



For the stage  $i=1$ , the reproduction value  $R$  also needs to be calculated. Similarly to the Malej and Malej (1992) matrix population model, the projection matrix would change during the year to reflect the reproductive cycle of *P. noctiluca*. All coefficients are fixed except for  $R$  which changes depending on the month of year. Malej and Malej (1992) determined that *P. noctiluca* reproduces from April to November, however other studies contradict this. The actual spawning period is not clearly defined: Avian et al. (1983) and Rottini-Sandrini and Avian (1991) suggest that reproduction occurs all year with an increase in autumn; Piccinetti et al. (1991) report reproduction is highest in winter; according to Goy et al. (Goy et al. 1989) reproduction is highest from May to August; and Rosa et al. (2013) suggest that maximum activity occurs in late autumn-winter. Given that our data set is based on that from Rosa et al. (2013), we decided to use the same spawning period – October to January.

So for a time series with monthly observations (with January at  $t=1$ ) and stage  $i > 1$ ,

If  $t \text{ modulo } 12 \leq 1$  or  $t \text{ modulo } 12 \geq 10$ :

$$\begin{pmatrix} n_1(2) \\ \vdots \\ n_1(T) \end{pmatrix} = \begin{pmatrix} n_4(1) & n_1(1) \\ \vdots & \vdots \\ n_4(T-1) & n_1(T-1) \end{pmatrix} \begin{pmatrix} R_4 \\ L_1 \end{pmatrix}$$

If  $2 \leq t \text{ modulo } 12 \leq 9$ :

$$\begin{pmatrix} n_1(2) \\ \vdots \\ n_1(T) \end{pmatrix} = \begin{pmatrix} n_4(1) & n_1(1) \\ \vdots & \vdots \\ n_4(T-1) & n_1(T-1) \end{pmatrix} \begin{pmatrix} 0 \\ L_1 \end{pmatrix}$$

The projection matrices were calculated using the previously described technique and revealed the following:

$$\text{February – September: } \begin{bmatrix} 0.350 & 0 & 0 & 0 \\ 0.298 & 0.650 & 0 & 0 \\ 0 & 0.003 & 0.201 & 0 \\ 0 & 0 & 0.498 & 0.418 \end{bmatrix}$$

$$\text{October – January: } \begin{bmatrix} 0.350 & 0 & 0 & 2436 \\ 0.298 & 0.650 & 0 & 0 \\ 0 & 0.003 & 0.201 & 0 \\ 0 & 0 & 0.498 & 0.418 \end{bmatrix}$$

### Appendix XIII: Published papers

The first paper “The Systems Approach Framework as a Complementary Methodology of Adaptive Management: a Case Study in the Urban Beaches of Barcelona” was published in *Ecology and Society* (Impact factor: 2.669)

The second paper “Systems approach modelling of the interactive effects of fisheries, jellyfish and tourism in the Catalan coast” has been accepted by *Estuarine Coastal and Shelf Science* (Impact factor: 2.324)





*Research*, part of a Special Feature on [A Systems Approach for Sustainable Development in Coastal Zones](#)

## The Systems Approach Framework as a Complementary Methodology of Adaptive Management: a Case Study in the Urban Beaches of Barcelona

*Ben Tomlinson*<sup>1</sup>, *Sergio Sastre*<sup>1</sup>, *Dolors Blasco*<sup>1</sup>, and *Jorge Guillén*<sup>1</sup>

**ABSTRACT.** The Systems Approach Framework is a methodological framework designed to enhance the efficacy of human decision-making processes within social-ecological systems with regard to sustainability. The objective of resilience adaptive management is to either maintain the system within the current regime such that the desired ecosystem goods and services continue to be delivered, or to move the system phase to a preferred regime. Although the objectives of the two frameworks are not exactly the same, there are considerable complementarities between them. Through application of the Systems Approach Framework in a case study regarding the urban beaches of Barcelona, Spain, we present some of the main findings revealed during the model construction and stakeholder participatory process. Additionally, we demonstrate that the Systems Approach Framework could be considered a useful step-by-step methodological guide that employs many of the vital components and processes of adaptive management.

**Key Words:** *adaptive management; Barcelona; coastal management; Spain; Systems Approach Framework; urban beach*

### INTRODUCTION

Social-ecological systems are under ever increasing pressure from a variety of human drivers (Millennium Ecosystem Assessment 2005a). Holling (2001) and his colleagues (Folke et al. 2002, Folke 2006, Folke et al. 2010) established a path for understanding complex social-ecological systems within a trans-disciplinary framework in which the concept of resilience is the guiding principle. Resilience of social-ecological systems can be defined as the capacity of a system to absorb shocks or disturbances so that the system retains or can easily return to the same basic structure of functioning (Holling and Gunderson 2001). The aim of adaptive management (AM) as proposed by the Resilience Alliance is to either maintain the system within the current regime such that the desired ecosystem goods and services are continued to be delivered, or move the system phase to a preferred regime (Walker et al. 2002, Gunderson 2008, Chapin et al. 2009).

Coastal zones are a prime example of valuable social-ecological systems under pressure (Costanza 1998, Millennium Ecosystem Assessment 2005b, Costanza and Farley 2007, Martinez et al. 2007), and following the introduction of integrated coastal zone management (King 2003) concepts, a number of methodological frameworks have been suggested to enhance the efficacy of human decision-making processes with regard to sustainability (European Parliament and Council 2002, McKenna and Cooper 2006). One such framework is the Systems Approach Framework (SAF) developed and tested during the four-year FP6 European Union project “Science and Policy Integration for Coastal System Assessment” (SPICOSA 2011a). The SAF was piloted in 18 different study sites (including the case presented here) in order to test the application of the methodology to a varied set of social-ecological systems, although always within the domain of coastal zones. However, it should be noted that the methodology can be applied to any

social-ecological system, not only those encountered in coastal zones.

Our aim is to examine how the SAF can be complementary to and useful for AM by using a case study from Barcelona, Spain. Our hypothesis is that the SAF could work as a framework that is nested within, or is complementary to, AM applications by offering a specific step-by-step methodological guide that is useful in determined contexts.

Given that our primary objective is to compare the SAF and AM, and due to the journal’s length limitation, it is beyond the scope of this paper to analyze and comment on all the specifics of the application of the SAF in our study site. Data collection, treatment, and analysis; modeling processes; model validation; uncertainty analysis; and the complete output from the model all deserve greater analysis than we can deliver in this paper. The complete analysis of the model will be developed in additional publications. Similarly, there is insufficient space to analyze all interactions with the stakeholders, so only the key representative aspects are presented to demonstrate an example of SAF application and how it relates to AM.

Our study represents the first comparison of the SAF with a pre-existing tool for management. By doing so, we demonstrate the advantages and disadvantages of the SAF and how it compares to other decision-making frameworks.

### The Systems Approach Framework

The SAF methodology is an iterative process in which continuous assessment of the relevant part of the social-ecological system provides scientifically defensible information with regards to possible and probable future changes given certain scenarios. The theoretical background of the SAF is based on General Systems Theory (von Bertalanffy 1968) and Soft Systems Methodology (Checkland

<sup>1</sup>Institut de Ciències del Mar (CSIC)

and Scholes 1990) in which model simulations of various scenarios and management options can be used to aid stakeholder engagement, thereby improving the science-policy interface (SPICOSA 2011b).

The methodology contains four steps: system design, system formulation, system appraisal, and system output. There should be considerable cooperation and consultation between the relevant stakeholders (end-users, policy makers, scientists, governance agencies, other relevant institutions, and nongovernmental organizations) throughout the process.

Additional details regarding the methodology can be found in the introduction paper of this special issue (Hopkins et al. 2011), as well as in the SAF online handbook (SPICOSA 2011b) and textbook (Tett et al. 2011). Similarly, all the documentation and models regarding the application of the SAF to the Barcelona case study are provided on the SPICOSA website (SPICOSA 2011c).

#### Adaptive management

Adaptive management as proposed by Resilience Alliance (2007) uses management not only as a tool to change the system but also to learn about it. Key objectives of AM include making explicit underlying assumptions and identifying unknown issues. This helps reduce the use of “best guess” strategies and strengthens the link between knowledge and action (Holling and Meffe 1996, Westley 2001).

The following are considered to be vital procedural components of adaptive management:

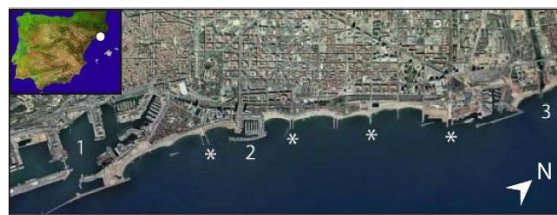
- consideration of appropriate temporal and spatial scales
- use of computer models to build synthesis and an embodied ecological consensus
- use of embodied ecological consensus to evaluate strategic alternatives
- communication of alternatives to political arena for negotiation
- inclusion of all relevant stakeholders
- political openness
- social and scientific processes
- encouragement regarding the formation of new institutions and strategies
- enhancement of institutional flexibility (Resilience Alliance 2002)

#### The Barcelona case study

The large metropolitan city of Barcelona is situated in the northeast of the Iberian Peninsula and is nested between four geographical limits: the Mediterranean Sea to the east, the Serra de Collserola mountain range to the west, the River Besòs to the north, and the River Llobregat to the south.

Barcelona is the capital of Catalonia, one of the most populated autonomous communities in Spain. There are more than 1.5 million inhabitants in the city itself, but almost 5 million people live in the area directly influenced by the city. The economy is focused largely on the service sector.

**Fig. 1.** Coastline of Barcelona, indicating beaches, industrial harbors (1), recreational harbors (2), combined sewer overflow outlets (\*), and the mouth of the River Besòs (3). (Data source: Cartographic Institute of Catalonia)



Maritime trade has been always important to the city, so the necessity of having a safe harbor has been one of the most pressing forces in changing the littoral profile of the city. Barcelona's coastline can be considered altered or artificial since the beginning of the 15<sup>th</sup> century when the first transformations were made to enhance the protection of trade ships. The construction of dykes and breakwaters led to corresponding changes in sedimentary flows and the reclamation of almost 400 m of land from the sea. However, throughout the following centuries, the city has modified its relationship with the sea, and different ecosystem services have been prioritized (Novoa and Alemany 2005).

The Olympic Games in 1992 and the Universal Forum of Cultures in 2004 were two internationally recognized events that reshaped Barcelona, both figuratively as a city, and literally in terms of its coastline. The existing industrial infrastructure was replaced with artificial beaches within an urban environment, which provided a leisure space for both residents and tourists. Fishing was also of considerable economic significance, but following the industrial revolution, its importance dramatically decreased and became a marginal traditional activity (Roig 1927, Bas et al. 1955).

Whereas in the past the main ecosystem services were related to food, transport, and waste disposal, nowadays navigation, recreation, and tourism can be considered the most important services for management issues (Novoa and Alemany 2005). The large industrial harbor and the public use of beaches for leisure are the two main uses of Barcelona's urban littoral space (Fig. 1).

There is an increasing trend in the promotion of intensive-use urban artificial beaches for tourism in many large cities on the

**Table 1.** List of stakeholders and meetings attended.

Scale	Organization	Responsibilities	Participation in Systems Approach Framework	Issues raised by stakeholders during first meeting
<b>State (Spanish government)</b>				
	Directorate of Coasts (Ministry of Environment)	Coastal spatial planning; public infrastructures; licensing; harbor administration	Contacted: attended first meeting	Erosion of beaches, especially during storms; toxic waste buried in offshore sand due to historic industrial activities; illegal recreational fishing near sewerage outlets
	Ministry of Works	Public Infrastructures	Not contacted	
<b>Regional (Catalan government)</b>				
	Directorate General of Fisheries	Recreational and commercial fisheries; monitoring	Contacted: attended first meeting	Municipal solid waste in artisanal fishing zones; effect of new coastal infrastructures on water quality; creation of artificial reefs
	Catalan Water Agency	Water management; waste water management; stormwater collectors planning; river basin planning; infrastructures; public information; flooding control; application of Water Framework and Bathing Water Directives; monitoring	Contacted: attended all meetings	Water quality following combined sewer overflows; efficacy of stormwater collectors related to water quality; erosion of beaches; jellyfish strandings; compliance with European Union directives
<b>Local (Barcelona)</b>				
	Department of Parks and Gardens	Beaches maintenance; end user satisfaction; water quality monitoring; noise control; licensing of businesses on the beach; public information; waste collection	Contacted: attended first and fourth meeting	Water quality following combined sewer overflows; erosion of beaches; jellyfish strandings; compliance with European Union directives
	CLABSA† (Private sector)	Sewage management and monitoring; stormwater collectors management	Contacted: attended the fourth meeting and a post-project meeting	
	Recreational Harbor	Licensing; waste management within the harbor	Contacted: attended first meeting	Anti-fouling paint; gasoline spills; effect of River Besòs storm plume; dredging entrance of port; pollution from port restaurants and bars
	EMSSA‡ (Private sector)	River Besòs wastewater treatment plant management	Contacted: no reply	

† CLABSA: Clavegueram de Barcelona, Sociedad Anónima

‡ EMSSA: Empresa Metropolitana de Sanejament, Sociedad Anónima

Mediterranean Sea coast (Nicholls and Hoozemans 1996), but there has been little analysis of the possible interactions between the ecological, social, and economic components of the social-ecological system. This made Barcelona an interesting study site in which the capabilities of the SAF could be explored in a representative case of urban beaches on the Mediterranean Sea.

## METHODS AND RESULTS

### System design: stakeholder identification and participation in defining the system and the issue

Adaptive management and the Systems Approach Framework share the common philosophy that the process of management should be both social and scientific, and should involve stakeholders in constructing conceptual models (mathematical or otherwise) to improve the understanding of the system

(Resilience Alliance 2002, Chapin et al. 2009); to use different knowledge systems, including both local and scientific; to integrate various disciplines; and during decision-making and deliberations with stakeholders. AM advocates “social network analysis” (Resilience Alliance 2007, Ernstson et al. 2008), and SAF suggests, although does not necessarily require, the use of stakeholder mapping. Both techniques are employed to understand the existence of social relations, how they relate to each other, and the power structure within and between them (Prell et al. 2009, Reed et al. 2009).

Following a brief examination of the system, it became evident that the stakeholder consensus view was to conserve the information functions of the ecological system, specifically the recreational, aesthetic, and cultural services (See *Discussion* for further analysis).

In implementing the SAF methodology to the study site application of the urban beaches of Barcelona, a provisional institutional and stakeholder map was formed. At the time, there was no known existing forum for these stakeholders to interact at the city scale, so we created one to meet the objectives of our SAF application.

During the initial discussions about who would be invited to the first meeting, there was disagreement among the scientific group as to whether the more “conflictive” stakeholders (such as environmental nongovernmental organizations, surfers, local residents) should be included or not. The other stakeholders with more power in decision-making processes (public administrators) might have objected to their inclusion and therefore chosen not to attend the meeting, effectively ending the process before it started. It was decided that the potentially more conflictive stakeholders would not be invited initially but possibly would be included later following consultation with the other stakeholders. Public administrators would, in general, already be aware of the concerns of the more conflictive stakeholders. Table 1 provides a list of the stakeholders, their responsibilities, the meetings each one attended, and the issues they raised during the first stakeholder meeting.

During the first meeting, it became clear that a common issue of interest to most stakeholders was water quality, particularly following combined sewer overflow events. The interest in this issue arose partly from compliance obligations to various European Union directives (Directive 2000/60/EC, Directive 2006/7/EC), and partly because of a connection to the stakeholders’ work responsibilities (e.g., decline in tourism at the recreational harbor caused by poor local environmental conditions).

The research team determined that it had sufficient data and expertise to analyze this problem, so it was decided that the issue to be investigated would be “the effects of changes in water quality on the aesthetic and recreational services of the Barcelona beaches”. Water quality was defined in terms of aquatic pathogenic organisms and water clarity, using fecal coliforms and suspended matter as indicators, respectively. Apart from combined sewer overflow events, other important factors that affect coastal water quality include one or more of the following factors: re-suspension of sediment caused by waves, inputs from local rivers, inputs from the local wastewater treatment plant, and flushing rates of the beaches. Neither the stakeholders nor the scientists viewed phytoplankton as having a significant effect on water clarity. Existing mitigation methods include the output of the wastewater treatment plant at a distance of 3 km from the beaches (whereas before it was much nearer) and the use of stormwater collectors to reduce combined sewer overflows.

Similarly to AM, the SAF recommends making a preliminary mental or conceptual model of the issue in order to identify

the main structures and relationships among them, as well as the relevant scales to be analyzed. Following stakeholder deliberation and expert consultation, all the relevant elements and links within and between the ecological, social, and economic components of the issue were mapped as a conceptual model. The stakeholders were encouraged to participate in this process in order to create a shared vision of the issue, its causes and drivers, and possible future scenarios, and to provide any data necessary to calibrate the mathematical model. Fig. 2 illustrates this shared vision of the system as agreed by the research team with the stakeholders. This conceptual model was the same one presented to the Commission on Coastal Affairs during the output step.

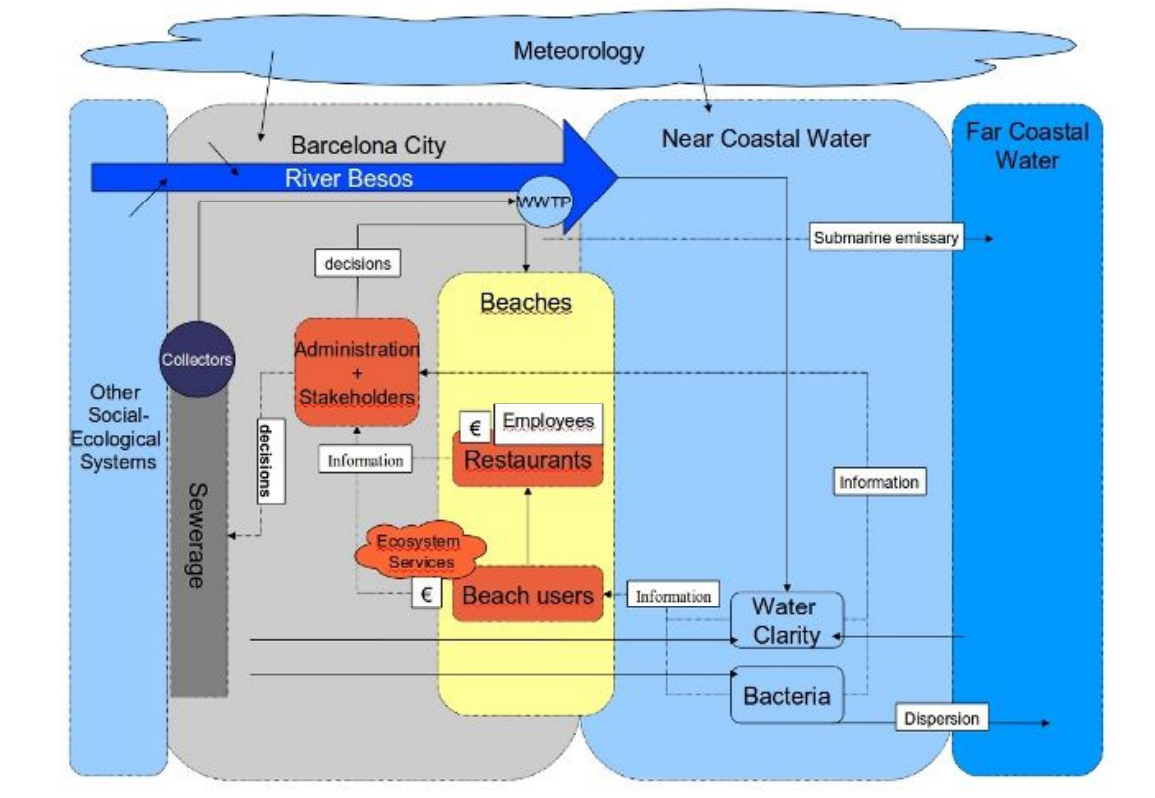
During this process, it became evident that a certain stakeholder held important information regarding the accurate functioning of part of the system but did not want to participate in the application of the methodology. There were a number of possible reasons for this, including lack of available time, resources, personnel, or interest, but the most likely reason was that the stakeholder, a private contractor for the regional government, could lose revenue due to the possible conclusions of the methodology. The lack of involvement of this key stakeholder resulted in an oversimplified representation being used in the mathematical model. This has obvious implications for the veracity of the model and therefore also its credibility among other stakeholders. Although the general structure of the model and key variables would remain the same, the inclusion of the missing information, when available, could later improve the model. It should be noted that until the missing information is included in the model, it is unknown whether the overall conclusions would be different.

#### **System formulation and system appraisal: developing the mathematical model from the conceptual model, and exploring outputs and scenarios**

The SAF urges the use of a participatory modeling approach in which stakeholders play a role in certain aspects of system formulation, such as the advising of indicators and relevance of scenarios. However, in our case study this was not entirely possible due to a combination of a tight project schedule and time, resources, and personnel constraints of the stakeholders. However, this does not imply a lack of interest in the model on behalf of the stakeholders. They offered data for parameterization and validation, and advice in the conceptual design and mathematical model, and were keen to use the model following its completion (during the first iteration of the SAF). Similarly, stakeholders (Catalan Water Agency, Department of Parks and Gardens) commented that for those involved exclusively in maintaining the ecological aspects of the system, it was interesting to see the possible socioeconomic impact of the ecological disturbance and the feedback effect on the socioeconomic component.



**Fig. 2.** Conceptual model of the system. The model was refined from the first meeting to the third, and includes those aspects that arose during the whole process of modeling. The format was suggested by the Catalan Water Agency during the second meeting. A simple PowerPoint diagram was chosen as a familiar way of visualizing information for all the stakeholders.



Due to the complexity of most issues regarding ecological, social, and economic interactions in the coastal zone, the SAF methodology recommends construction of a systems dynamic model. Similar to AM, the new knowledge disclosed by the model must be understandable by all stakeholders and help in consensus building. Constructing the model hierarchically allows each user to investigate each component to the precision they require or can understand. The amenability of the model is paramount to its acceptance by the stakeholders without which, it is liable to suffer “black box” model syndrome. The purpose of the model simulations is to help increase the understanding of the functioning of the system. Due to time constraints, the scenarios were created following internal discussion within the scientific team instead of as a result of stakeholder consultation, as is recommended by the SAF. However, in later discussions, the stakeholders valued the scenarios as “reasonable and interesting”.

In the following section, some of the main findings revealed during the model construction process are presented. These sections highlight comparisons between the SAF and AM, and demonstrate the lessons learned in applying the SAF to our case study.

*Understanding the importance of various temporal scales*

When constructing a mathematical model, it is necessary to choose both a spatial and temporal scale. However, it is important to remember that the system itself is in a nested hierarchy of other systems that are all evolving through their own adaptive cycle (Holling and Gunderson 2001). The SAF does not attempt to model the “panarchy” of nested adaptive cycles, but during system formulation, the importance of the differences in scale between and within components becomes evident. In our study site application, there is a clear disconnect between economic effects (measured in money) and mitigation scenarios and the effect these would have on the



ecological component (i.e., reducing bacteria and/or turbidity) and on the social component. The construction of stormwater collectors is an expensive (and timely) process, and any possible real money recuperation of these costs would be lengthy and probably not possible. However, these costs might be justified by nonmarket valuation techniques, discussed in *Scenario analysis of the stormwater collectors*.

There is an inherent conflict between reducing beach regeneration caused by storm-related erosion (by constructing breakwaters) and increasing the flushing rate of the beaches, which is a problem directly related to temporal scale. On a daily basis, it would be advantageous to maximize the flushing rate to reduce water pollution from combined sewer overflow events (no breakwaters). However, on a yearly scale, the lack of breakwaters would leave the beaches susceptible to storm-related erosion. The model is set at a scale that includes only the daily changes to the system, but this conflict became evident during system formulation. Future iterations of the SAF process in this study site application could easily be adapted to include such conflicts.

#### Identification of the feedback loops

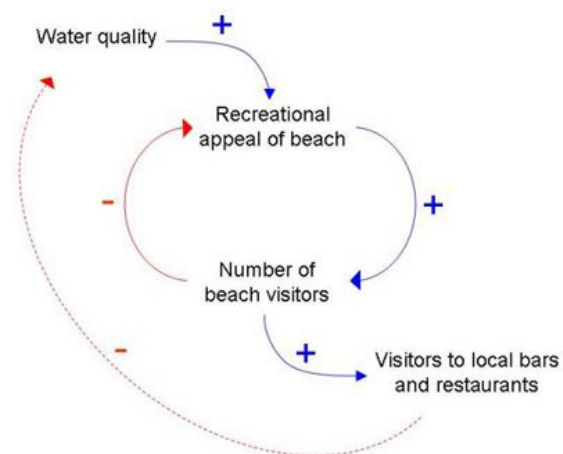
A crucial aspect of dynamic models is feedback loops, which, depending on whether they are positive or negative, can push the state away from or towards equilibrium or its attractor, possibly resulting in regime change. Modeling helps identify these loops. A significant negative feedback loop in our case study, where the system acts to oppose changes to the input of the system, is the recreational appeal of the beaches and its carrying capacity (Fig. 3).

#### Identifying missing key environmental and sociological data

A benefit of creating models, whether mathematical or conceptual, is that the importance and availability of key data can be identified, and it can be determined if they are available and are of a sufficient resolution (temporal or spatial). The collection of data is a costly process in terms of both resources and time. Having constructed and tested a model, it becomes evident which data have the most significant impact in the functioning of the system, and therefore which data would improve or validate the model's efficacy. The SAF advocates implementing continuous iterations of the methodology so that the model is continually adapted to the evolving reality and knowledge attained. This allows time for the key missing data to be collected, collated, and analyzed. It should be noted that in this study case, time constraints limited the application of the methodology to a single iteration.

During the formulation of the model for our case study, we became aware of key, unavailable, or incomplete data sets. Within the ecological component, there were not sufficient data to compare with the model output to provide comprehensive validation and verification. The available data sets for both bacteria and turbidity (equivalent to suspended

**Fig. 3.** Feedback loop in beach visitors. Even if water quality improved and the recreational appeal of the beach greatly increased, this would not necessarily result in a greater number of beach users because the beach would already be close to its recreational carrying capacity, especially during the summer months. (Recreational carrying capacity is defined as the number of beach visitors that are physically able to occupy the beach, limited by behavioral norms such as the distance at which the visitors are prepared to sit from each other [De Ruyck et al. 1997]). Conversely, if the recreational appeal decreased due to adverse water quality conditions, the number of visitors would not necessarily decrease significantly. People prefer less crowded beaches; therefore, as the number of visitors decreases due to poor water quality conditions, other people would likely visit because the beach would become less crowded. There is a possible feedback from water quality of the beaches to increased visitors to the local bars and restaurants (indicated by a dotted line), but we did not include this in our model due to a lack of available data.



matter) exist only at a maximum temporal resolution of biweekly and only during the summer months. The sampling rarely coincided with storms; thus, many of the peaks assumed to be produced during combined sewer overflow events were not recorded. Given a more complete set of observed values with which the model could be parameterized and verified, there would possibly be a need for a more complete set of other data regarding the ecological component of the model, such as river flow and amount of suspended matter and bacteria; a more accurate functioning of the sewerage and stormwater collector system; greater detail regarding suspended matter and bacteria during combined sewer overflow events; and further studies regarding the flushing rate of the beaches.

A key connection between the ecological and social-economic components of the model is the change in recreational appeal of the beach. Recreational appeal is dependent on various events, such as beach closure due to bacteria limits being exceeded, and discolored or turbid water. Because insufficient data exist for this parameter, the model included a sliding scale in which the average beach user's susceptibility to adverse conditions could be modified from "none" to "very high". The numeric value for "very high" was estimated by the model's authors, although they conceded it could indeed be greater, however, improbable. This key link between the ecologic and social-economic component was deemed to be significant by the stakeholders (which is why they chose this particular issue during the first meeting); therefore, further analysis would be a crucial step in clarifying if this really is a significant issue or not. Understanding the magnitude of this connection is necessary for accurate assessment of cost-benefit analysis under the various scenarios.

#### *Scenario analysis of the stormwater collectors*

Analysis of the stormwater collector scenarios revealed that both increasing the capacity and reducing the direct runoff of the stormwater collectors could reduce both suspended matter and to a greater extent, bacteria, thereby reducing the number of beach closures by at least half (Table 2). Just increasing the collector capacity (but not reducing the direct runoff) would not decrease the number of days in which bacteria limits were exceeded or high concentrations of suspended matter occurred. A more effective policy would be to decrease the percent of combined sewer overflow runoff that is released directly into the coastal water without being directed towards the stormwater collectors. However, this option might not be physically or politically possible given that the primary objective of the stormwater collectors is to prevent flooding within the city—the quality of the coastal water is a secondary concern.

During stakeholder deliberations, the economic effect of perturbations to the system was requested as an output of the model. However, most clients of the surrounding local bars and restaurants do not originate from the beach. Although their motivation for visiting these bars is connected to the recreational and aesthetic qualities of the beach, it is not directly related to the quality of the water. There is a connection between the number of people who visit the beach (influenced by the quality of the water) and then attend a local bar or a restaurant; however, it is estimated to be small, according to surveys carried out by the research team—about five percent of bar and restaurant users come from the beach. Therefore, the real money influences of changes to water quality are relatively small, but by using nonmarket valuation methodologies, a broader version of "economic value" can be attained. The model incorporates a dynamic block that calculates an economic value for the information services of

the beach based on the number of visitors and where they originate from (the travel-cost method). This type of valuation is a positive step in including nonmarket values in an eventual cost and benefits accountability, which is rarely included in economic assessments (Ward and Beal 2000). Through the modeling process and stakeholder deliberation, desired outputs such as these can be requested and incorporated into the model. Stakeholders commented that understanding the economic magnitude of changes to ecological quality and its dependence on users' perceptions both helped them understand the system more clearly. A conclusion of the scenario analysis revealed that investment in additional stormwater collectors would have little effect on water quality, and thus a small impact on the monetary value of ecosystem services (Table 2).

In the case of the construction of additional stormwater collectors (and assuming that users' perception with regard to water quality is very high), the maximum degree of change in monetary benefits (to the local bars and restaurants) would be in the order of tens of thousands of Euros per year. This is relatively insignificant when compared to the cost of constructing additional stormwater collectors. Similarly, there is not much economic difference when comparing the nonmarket benefits of constructing additional stormwater collectors to their cost (Table 2).

#### **System output: presentation of the model, and deliberation of the results by stakeholders**

The SAF methodology does not intend to supply the "correct" answer to an issue or problem—it merely provides the stakeholders with a base from which to structure the debate. The model is just a tool that can provide further information, highlight complex processes, and clarify doubts. The scientists should not decide policy or make managerial decisions because this is the role of the stakeholders and policy makers, but they should be available to explain the implication of the model as well as its veracity and validity.

At the beginning of implementation of the SAF, an ad hoc forum was created for the relevant stakeholders to debate issues regarding the littoral areas of Barcelona. But due to time, resource, and personnel constraints, participation was less than exemplary. Towards the end of the SAF implementation, the scientific team discovered the existence of a regular organized forum between coastal stakeholders from all Catalonia (not just the local scale of Barcelona), the Commission of Coastal Affairs. The scientific team presented both the SAF methodology and the initial results of the model and their implication, as previously discussed in *System formulation and system appraisal*. A stakeholder who had previously declined (or ignored) the initial ad hoc forum attended this forum, and following the presentation, expressed interest in participating further in the process to help improve the model, possibly by supplying data and information.

**Table 2.** Stormwater collector scenarios. Scenario analysis is related to changes in operation of the stormwater collectors. The model operator (stakeholder) has the option of selecting two variables related to the sewerage system (capacity and direct runoff), as well as the sensitivity of beach users to changes in water quality (turbidity and runoff). Because this sensitivity is currently unknown, only the two extremes are shown in the table: none and high (both to bacteria and turbidity). The two extremes demonstrate the maximum possible difference to both the non-market and market value of the beaches for each scenario. The approximate cost of constructing the stormwater collectors for each scenario is included for comparison. It should also be noted that the number of turbid days is the same for both the “current” and “planned” scenarios because although increasing stormwater collector capacity does not affect “low” turbidity, it does affect “high” turbidity (although only by a small degree).

Variables/ Indicators	Units and details	Stormwater Collector Scenarios									
		No collectors (simulated)		Current		Current with improved runoff (simulated)		Planned (simulated)		Planned with improved runoff (simulated)	
Sewerage system	Capacity stormwater collectors (Gigaliter)	0		0.52		0.52		1.5		1.5	
	Runoff direct to coastal water (%)	100		50		0		50		0	
Bacteria	Number of days in the year in which limits are exceeded during the bathing season†	7.17		3.88		2.58		3.63		1.42	
Turbidity	Number of "turbid" days during the bathing season†	19.21		15.75		11.29		15.75		8.08	
	Number of "high turbidity" days during the bathing season†	1.29		0.75		0.58		0.71		0.42	
Beach user sensitivity	Beach user sensitivity to bacteria and turbidity	none	high	none	high	none	high	none	high	none	high
Beach users	Visitors per year (millions)	6.36	4.85	6.36	5.26	6.36	5.41	6.36	5.33	6.36	5.69
Non-market value	Travel cost evaluation per year (€ millions)	16.03	12.22	16.03	13.25	16.03	13.64	16.03	13.43	16.03	14.33
Market value	Revenue from bars and restaurants per year (€millions)	29.36	29.32	29.36	29.33	29.36	29.33	29.36	29.33	29.36	29.34
Cost stormwater collectors	Approximate construction costs per scenario (€millions)	0		150		150		450		450	

† The bathing season is from May until September, inclusive. The value for number of days is calculated from the annual average of a 5-year forecast period.

This entire process highlights an important aspect of participatory management. It demonstrates that a deficit in social capital (OECD 2001, Ostrom and Ahn 2003) can seriously deter any participatory management process. Even with pre-existing forums, they need to be at the correct scale for the chosen issue for the process to function adequately. However, for social capital to be built, confidence between the stakeholders needs to increase. The SAF methodology

offers an opportunity for this to occur. Through continuous iterations of the SAF, the stakeholders are likely to grow more confident with each other and observe the benefits in participation in the process. Increasing social capital is a lengthy process and cannot be achieved immediately, so it is not surprising that in our case study, the benefits started to appear only towards the end of the project, about three years after its initiation. No management decisions regarding the

stormwater collectors or other scenarios presented were made following the final stakeholder meeting. However, the application of the SAF demonstrated its ability to create and maintain social capital, which could be beneficial for future collaboration.

## DISCUSSION

### Comparing the Systems Approach Framework and adaptive management

The SAF could generally be classed as similar to a passive AM approach (Holling 1978, Walters 1986, Holling and Meffe 1996, Chapin et al. 2009), although this depends on the system in question, the stakeholders involved, their vision of the social-ecological system, and its associated issues. Passive AM uses whatever knowledge and information is available to improve the decision-making process. On the other hand, active AM tests the real system, pushing it to (ecological) limits in ways that would not normally be tried, thus providing learning about possible phase changes and a more complete understanding of the social-ecological system. Often, as in our case study, the objective of most policy makers and stakeholders is to maintain the social-ecological system in its current phase and not try to push it to another.

Most procedural components of AM are also advanced by the SAF methodology (Table 3). However, it should be noted that there is not always a direct one-to-one correlation; thus, some components of AM are referred to in more than one SAF “step”. This is not surprising given that we are comparing a step-by-step methodological guide (SAF) against a tool for management with generalized recommendations (AM). There are two components of AM that are not explicitly recommended by the SAF (“Encourage the formation of new institutions and strategies” and “Enhance institutional flexibility”), but neither does the SAF discourage them.

Conversely, there are no obvious SAF steps or tasks that could be considered outside of, or contrary to, the recommendations of AM. However, the SAF is more specific in its methodology—for example, in its use of General Systems Theory as the foundation for modeling, and in recommending software that can be easily used by layperson stakeholders. Both the SAF and AM recommend considering the issue across different temporal and spatial scales. However, within the SAF, a specific scale has to be chosen in order to create a model, although this could change over additional iterations of a given application. AM does not specify exactly how to confront the difficulties involved in creating a computer model across various temporal and spatial scales.

### The application of the Systems Approach Framework in Barcelona

Table 3 also outlines the most important steps in applying the SAF to our case study and how we deviated from the recommended methodology. There were key problems

involved in the application, such as failing to identify existing stakeholder forums. This might have saved considerable time in trying to construct a separate forum where one key stakeholder initially chose not to attend. Had we known about the pre-existing forum (which this stakeholder attends), progress would have been quicker regarding both construction of the model and the deliberation process.

Another significant problem encountered involved constructing the model with a lack of information (regarding the correct functioning of the sewerage and stormwater collectors) and a lack of data for calibration and verification. The software used was beneficial in constructing a model that the stakeholders could both easily understand (due to its hierarchical structure) and manipulate (drop-down menus for running various scenarios). To some extent, this diminished the “black box syndrome” that many models suffer, and encouraged the stakeholders to further engage with the model output. We emphasized the uncertainty in the model output but were confident that the orders of magnitude were correct. Comparison with other economic valuation studies had revealed similar results (Ceballos 2008, Brenner et al. 2010).

Many of the processes considered to be vital procedural components of AM (Resilience Alliance 2007) are also advocated within the SAF. However, in our case study, we determined that for these processes to be effectively applied, there needs to be adequate social capital, which can take time to build if it does not already exist. As demonstrated in our case study, the SAF can advance the formation of such relevant networks and institutions in which social capital can burgeon. It is probable that in further iterations of the SAF, the processes advocated by AM would be developed more comprehensively.

### Speculation

There are a number of subtle differences between the SAF and AM in terms of the emphasis of objectives and procedures, which are not highlighted in Table 3 because they are more speculative. For example, in the SAF, the process starts with scientists who choose a set of stakeholders and together they investigate an issue by choosing the relevant scale together. On the other hand, AM has little to say about how the process starts or whether it should focus on just one management issue or model the entire ecosystem. Because of this, it could be argued that the SAF puts greater emphasis on solving individual issues, decision-making processes, and sustainability, whereas AM puts greater emphasis on sustainability, resilience (passive AM), and testing and learning from the ecosystem (active AM).

The current phase regime in Barcelona is one where typical coastline ecosystem services such as food production and fish nurseries have decreased, and in their place information services such as recreation and aesthetic appeal are favored. This has been implicitly decided by the city’s residents, although they may be unaware of the large costs (in energy,

**Table 3.** Comparison of the Systems Approach Framework (SAF) and adaptive management: application of SAF to Barcelona.

Systems Approach Framework† (SAF)		Adaptive management‡	Barcelona case study (How the SAF was applied)	Comments (Deviation from recommended steps and difficulties encountered)
Steps	Tasks	Procedural components		
The aim is to improve ecological sustainability, economic efficiency, and social equity – similar to “passive” adaptive management		Can be either “active” or “passive” adaptive management		
System design	Identify stakeholders; identify issues; define “virtual” system, structure, and functions; set boundaries; conceptual modeling	Inclusion of all relevant stakeholders; creation and maintenance of political openness; social and scientific process	Following stakeholder mapping (Table 1), invitations were sent to the administrative bodies from the three main scales of responsibility over the Barcelona beaches (local, regional, and national). The first meeting was held on 11 October 2007. An issue was agreed upon between the five stakeholders and the ICM-CSIC§ research team involved in SPICOSA]: “the effects of changes in water quality on the aesthetic and recreational services of the Barcelona beaches”, and a first draft of the conceptual model was constructed.	Following an agreement between the research team, the stakeholders were selected to maximize representativeness and minimize the likelihood of conflicts. The SAF recommends including a greater representation of stakeholders.
System formulation and appraisal	Construct mathematical model, scenarios; parameterize; validate; choose indicators; assess relevance for stakeholders; interpret results	Consideration of appropriate temporal and spatial scales; use of computer models to build synthesis and an embodied ecological consensus	A hierarchical model which included ecological, social, and economic variables was constructed, and the key indicators were water clarity, bacteria concentration, beach user frequentation, and market and non-market valuation of aesthetic and recreational services. A second stakeholder meeting was held on 26 February 2009. The primary scenarios identified as relevant for stakeholders were related to changes in stormwater collector capacity and functioning. Additional scenarios included changes in wastewater treatment plant operational states, river flows and concentrations of bacteria and suspended matter, precipitation, and flushing rates of the beaches.	We were unable to obtain key data and information necessary to construct and validate the mathematical model to a rigorous standard. Future iterations of the SAF might yield the time, resources, and cooperation necessary to address these deficiencies.
System output	Present results to stakeholders; organize information; deliberate	Use of embodied ecological consensus to evaluate strategic alternatives; use of computer models to build synthesis and an embodied ecological consensus; communication of alternatives to political arena for negotiation; inclusion of all relevant stakeholders; creation and maintenance of political openness; social and scientific process	Results were presented twice, first in a private meeting held on 10 March 2010 with the Catalan Water Agency. Shortly afterwards on 23 March 2010, the results and conclusions were presented to the Commission of Coastal Affairs (a pre-existing forum where coastal issues are discussed at the regional level). There was no time for deliberation, but a few stakeholders approached us afterwards regarding the conclusion of the model.  Additionally, the key stakeholder who had declined to attend our previous meetings (but was present here) was now keen to share their time, data, and expertise with us, given that the model produced results that were contrary to their economics interests.	The forum of the Commission of Coastal Affairs was discovered late in the application of the SAF, and the fact that it was not identified earlier should be considered a failure of the scientific team. Given the social capital already invested in this commission, it would have been preferable to apply the SAF here rather than creating ad hoc meetings as we did.

(con'd)



---

Encourage the formation of new institutions and strategies; enhancement of institutional flexibility

The SAF can provide policy strategies as options but does not explicitly recommend these components of adaptive management.

---

† SPICOSA (2011c)

‡ Resilience Alliance (2002)

§ ICM: Institut de Ciències del Mar; CSIC: Consejo Superior de Investigaciones Científicas

| Science and Policy Integration for Coastal System Assessment

---

resources, money, and personnel) involved in maintaining the beaches in their current state. During shocks to the social-ecological system (e.g., general economic crisis, increase in price of energy, increased storm activity and erosion caused by climate change, sea-level rise), there might be less impetus by the public to continue with this sort of investment, and the beaches would slowly transform to a regime that does not require a constant input of exosomatic energy and resources in order to be perpetuated. Any type of resilience management has to examine the issue explored in this paper through the lens of this implication. The application of this first iteration of the SAF to the case study of Barcelona sufficiently explores various scenarios as requested by the stakeholders but from the perspective of a reduced temporal scale. Through further iterations, it would be possible to include shocks to examine the resilience of the social-ecological system over a larger temporal scale, thus approaching the objectives of AM.

#### *The future of the Systems Approach Framework*

It is difficult to suggest improvements to the design of the SAF because it is an open methodological framework. The most technical aspects of the methodology, such as stakeholder interaction and construction of the model, are not rigidly defined, and are therefore open to a degree of interpretation. This has the obvious drawback of requiring experts to aid in the process but leaves it sufficiently open so that the methodology can be applied to a diverse set of issues across varying cultural and political communities.

Similar to any social policy or strategy, it is difficult to predict the future trajectory that the SAF will take. As a tool for management, it requires significant time, resources, and personnel. For the process to run smoothly, there needs to be trans-disciplinary scientists or at least scientists capable of understanding and communicating outside of their own specialization, modelers who can interact with all disciplines and are familiar with general systems theory, and social scientists trained in stakeholder deliberation. The true limitations might lie in attempting to confront the existing power structure of institutions and organizations by convincing them to engage in the process.

Within the SPICOSA project, the process was largely funded by the European Union (by the Framework Programme for Research and Technological Development). However, such research funds cannot subsidize all future implementations of the SAF—there has to be shared responsibility between science and policy. Obviously, for the policy makers to invest in the process and justify the expenditure at the political level, they would have to see the benefits either from previous implementations of the SAF or from envisaging the possible advantages of future iterations.

The SAF is a well-structured methodology for cases where a mathematical model is both relevant and feasible with regards to both knowledge of the functioning of each component of the social-ecological system and the availability of data, resources, and personnel. The SAF should be considered as a useful step-by-step guide for certain contexts, and could either be classified as a nested framework within AM or as a complementary methodology of AM.

*Responses to this article can be read online at:*

<http://www.ecologyandsociety.org/vol16/iss4/art28/responses/>

---

#### **Acknowledgments:**

*The authors would like to thank all the stakeholders involved in this experiment, particularly those at the Catalan Water Agency, who were very cooperative and helpful in assisting us throughout the whole process. We would also like to thank the subject editor and the two anonymous reviewers for their concise and constructive comments which helped improve this article.*

---

#### **LITERATURE CITED**

Bas, C., E. Morales, and M. Rubió. 1955. *La pesca en España y Cataluña*. Instituto de Investigaciones Pesqueras, CSIC, Barcelona, Spain.

Brenner, J., J. A. Jiménez, R. Sarda, and A. Garola. 2010. An assessment of the non-market value of the ecosystem services

- provided by the Catalan coastal zone, Spain. *Ocean & Coastal Management* 53(1):27–38. [online] URL: <http://dx.doi.org/10.1016/j.ocecoaman.2009.10.008>
- Ceballos, D. 2008. Valoración de un recurso natural. Un caso de comparación entre diferentes alternativas de valoración global. *Anales de Economía Aplicada*. Número XXII.
- Chapin, III, F. S., G. P. Kofinas, and C. Folke, editors. 2009. *Principles of ecosystem stewardship: resilience-based natural resource management in a changing world*. Springer Science + Business Media, New York, USA. [online] URL: <http://www.springerlink.com/content/978-0-387-73033-2#section=61977&page=1>
- Checkland, P. B., and J. Scholes. 1990. *Soft systems methodology in action*. John Wiley and Sons, Chichester, UK.
- Costanza, R. 1998. The ecological, economic and social importance of the oceans. *Ecological Economics* 31(2):199–213. [online] URL: [http://dx.doi.org/10.1016/S0921-8009\(99\)00079-8](http://dx.doi.org/10.1016/S0921-8009(99)00079-8)
- Costanza, R., and J. Farley. 2007. Ecological economics of coastal disasters: introduction to the special issue. *Ecological Economics* 63(2-3):249–253. [online] URL: <http://dx.doi.org/10.1016/j.ecolecon.2007.03.002>
- De Ruyck, M. C., A. G. Soares, and A. McLachlan. 1997. Social carrying capacity as a management tool for sandy beaches. *Journal of Coastal Research* 13(3):822–830. [online] URL: <http://www.jstor.org/pss/4298675>
- Directive 2000/60/EC of the European Parliament and of the Council establishing a framework for community action in the field of water policy. *Official Journal of the European Communities L Legis 2000* 327:1–73.
- Directive 2006/7/EC of the European Parliament and of the Council of 15 February (2006) concerning the management of bathing water quality and repealing Directive 76/160/EEC. *Official Journal of the European Union* 4.3.2006, L64/37.
- Ernstson, H., S. Sörlin, and T. Elmqvist. 2008. Social movements and ecosystem services—the role of social network structure in protecting and managing urban green areas in Stockholm. *Ecology and Society* 13(2):39. [online] URL: <http://www.ecologyandsociety.org/vol13/iss2/art39/>
- European Parliament and Council. 2002. Recommendation of the European Parliament and of the Council of 30 May 2002 concerning the implementation of integrated coastal zone management in Europe (2002/413/EC). *OJ L148 06.06.2002 Official Journal of the European Communities* 2002:24–7.
- Folke, C. 2006. Resilience: the emergence of a perspective for social-ecological systems analyses. *Global Environmental Change* 16:253–267. [online] URL: <http://dx.doi.org/10.1016/j.gloenvcha.2006.04.002>
- Folke, C., S. Carpenter, T. Elmqvist, L. Gunderson, C. S. Holling, and B. Walker. 2002. Resilience and sustainable development: building adaptive capacity in a world of transformations. *Ambio* 31(5):437–440. [online] URL: <http://www.bioone.org/doi/full/10.1579/0044-7447-31.5.437>
- Folke, C., S. R. Carpenter, B. Walker, M. Scheffer, T. Chapin, and J. Rockström. 2010. Resilience thinking: integrating resilience, adaptability and transformability. *Ecology and Society* 15(4):20. [online] URL: <http://www.ecologyandsociety.org/vol15/iss4/art20/>
- Gunderson, L. 2008. Adaptive management and integrative assessments. Pages 55–59 in S. E. Jorgensen and B. Fath, editor(s)-in-chief. *Encyclopedia of Ecology*. Academic Press, Oxford, UK.
- Holling, C. S. 1978. *Adaptive environmental assessment and management*. Wiley, London, UK. Reprinted in 2005 by Blackburn Press, Caldwell, New Jersey, USA.
- Holling, C. S. 2001. Understanding the complexity of economic, ecological, and social systems. *Ecosystems* 4(5):390–405. [online] URL: <http://dx.doi.org/10.1007/s10021-001-0101-5>
- Holling, C. S., and L. H. Gunderson. 2001. Resilience and adaptive cycles. Pages 25–62 in L. H. Gunderson and C. S. Holling, editors. *Panarchy: understanding transformations in human and natural systems*. Island Press, Washington D.C., USA.
- Holling, C. S., and G. K. Meffe. 1996. Command and control and the pathology of natural resource management. *Conservation Biology* 10(2):328–337. [online] URL: <http://onlinelibrary.wiley.com/doi/10.1046/j.1523-1739.1996.10020328.x/abstract>
- Hopkins, T. S., D. Bailly, and J. G. Støttrup. 2011. A systems approach framework for coastal zones. *Ecology and Society* 16(4): 25. <http://dx.doi.org/10.5751/ES-04553-160425>
- King, G. 2003. The role of participation in the European demonstration projects in ICZM. *Coastal Management* 31(2):137–143. [online] URL: <http://dx.doi.org/10.1080/08920750390168354>
- Martinez, M. L., A. Intralawan, G. Vazquez, O. Perez-Maqueo, P. Sutton, and R. Landgrave. 2007. The coasts of our world: ecological, economic and social importance. *Ecological Economics* 63(2-3):254–272. [online] URL: <http://www.sciencedirect.com/science/article/pii/S0921800906005465>  
<http://dx.doi.org/10.1016/j.ecolecon.2006.10.022>
- McKenna, J., and J. A. G. Cooper. 2006. Sacred cows in coastal management. The need for a “cheap and transitory” model. *Area* 38(4):421–431. [online] URL: <http://dx.doi.org/10.1111/j.1475-4762.2006.00708.x>

Millennium Ecosystem Assessment. 2005a. *Ecosystems and human well-being: synthesis*. Island Press, Washington, D.C., USA.

Millennium Ecosystem Assessment. 2005b. Coastal systems. Pages 533–536 in *Ecosystems and human well-being: current state and trends*. Island Press, Washington, D.C., USA.

Nicholls, R. J., and F. M. J. Hoozemans. 1996. The Mediterranean: vulnerability to coastal implications of climate change. *Ocean & Coastal Management* 31(2-3):105–132. [online] URL: [http://dx.doi.org/10.1016/S0964-5691\(96\)00037-3](http://dx.doi.org/10.1016/S0964-5691(96)00037-3)

Novoa, M., and J. Alemany. 2005. *Evolución de la Costa de Barcelona*. Dirección General de Costas. Ministerio de Medio Ambiente, Madrid, Spain.

Organisation for Economic Co-operation and Development (OECD). 2001. *The well-being of nations: the role of human and social capital*. OECD, Paris, France.

Ostrom, E., and T. K. Ahn. 2003. *Foundations of social capital*. Edward Elgar Publishing, Cheltenham, UK.

Prell, C., K. Hubacek, and M. Reed. 2009. Stakeholder analysis and social network analysis in natural resources management. *Society and Natural Resources* 22(6):501–518. <http://dx.doi.org/10.1080/08941920802199202>

Reed M. S., A. Graves, N. Dandy, H. Posthumus, K. Hubacek, J. Morris, C. Prell, C. H. Quinn, and L. C. Stringer. 2009. Who's in and why? A typology of stakeholder analysis methods for natural resource management. *Journal of Environmental Management* 90(5):1933–1949. [online] URL: <http://www.sciencedirect.com/science/article/pii/S0301479709000024> <http://dx.doi.org/10.1016/j.jenvman.2009.01.001>

Resilience Alliance. 2002. Adaptive management. [online] URL: ([http://www.resalliance.org/index.php/adaptive\\_management](http://www.resalliance.org/index.php/adaptive_management))

Resilience Alliance. 2007. Assessing resilience in social-ecological systems: a scientists workbook. [online] URL: <http://www.resalliance.org/3871.php>

Roig, E. 1927. *Lapesca Catalunya*. Noray, Barcelona, Spain.

Science and Policy Integration for Coastal System Assessment (SPICOSA). 2011a. SPICOSA portal. [online] URL: <http://www.spicosa.eu>

Science and Policy Integration for Coastal System Assessment (SPICOSA). 2011b. Systems Approach Framework handbook. [online] URL: <http://www.coastal-saf.eu/>

Science and Policy Integration for Coastal System Assessment (SPICOSA). 2011c. Online data portal. [online] URL: <http://www.spicosa.eu/dataportal/index.htm>

Tett, P., A. Sandburg, and A. Mette. 2011. *Sustaining coastal zone systems*. Dunedin Academic Press, Edinburgh, Scotland.

von Bertalanffy, L. 1968. *General systems theory: foundations, development, applications*. George Braziller, New York, New York, USA. <http://dx.doi.org/10.1109/TSMC.1974.4309376>

Walker, B., S. Carpenter, J. Anderies, N. Abel, G. Cumming, M. Janssen, L. Lebel, J. Norberg, G. D. Peterson, and R. Pritchard. 2002. Resilience management in social-ecological systems: a working hypothesis for a participatory approach. *Conservation Ecology* 6(1):14. [online] URL: <http://www.ecologyandsociety.org/vol6/iss1/art14/>

Walters, C. 1986. *Adaptive management of renewable resources*. MacMillan, New York, New York, USA.

Ward, F. A., and D. J. Beal. 2000. *Valuing nature with travel cost models: a manual*. Edward Elgar Publishing, Cheltenham, UK.

Westley, F. 2001. The devil in the dynamics: adaptive management on the front lines. Pages 333–360 in L. H. Gunderson, L. H. and C. S. Holling, editors. *Panarchy: understanding transformations in human and natural systems*. Island Press, Washington D.C., USA.





**Title:**

Systems approach modelling of the interactive effects of fisheries, jellyfish and tourism in the Catalan coast.

**Authors:**

Tomlinson, Benjamin <sup>a,\*</sup>

Maynou, Francesc <sup>a</sup>

Sabatés, Ana <sup>a</sup>

Fuentes, Verónica <sup>a</sup>

Canepa, Antonio <sup>a</sup>

Sastre, Sergio <sup>a</sup>

<sup>a</sup> Institut de Ciències del Mar, CSIC, Passeig Marítim de la Barceloneta, 37-49, E08003 Barcelona, Spain

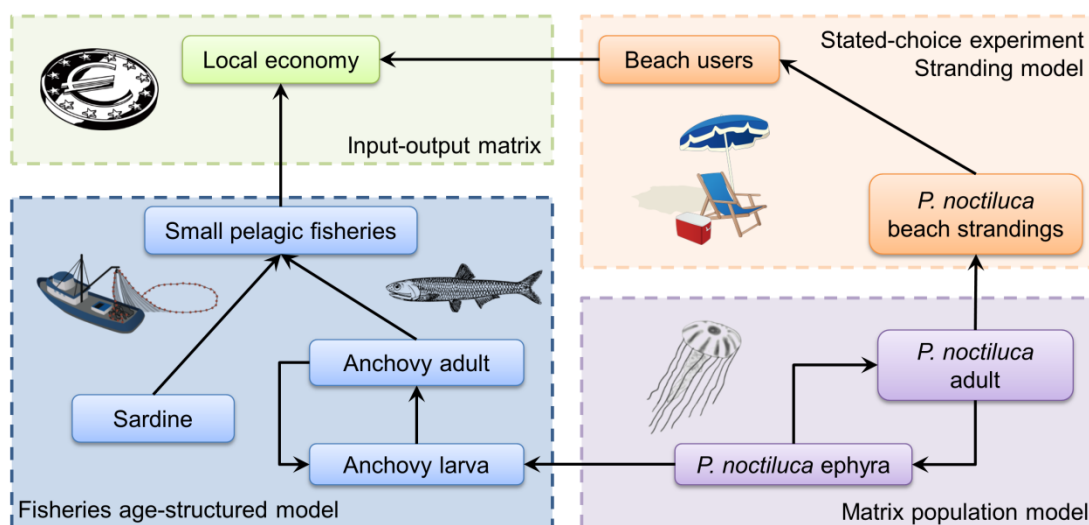
\* email: tomlinson@icm.csic.es

**Abstract:**

Despite the large fluctuation in annual recordings of gelatinous plankton along the Catalan coast in the north western Mediterranean and the lack of long term data sets, there is a general perception that jellyfish abundances are increasing. Local authorities are concerned about the stranding events and arrivals of jellyfish to beaches and believe it could reduce the recreational appeal of the beaches - a valuable ecosystem service for the regional tourist industry. Previous studies also demonstrate the predation of jellyfish (*Pelagia noctiluca* ephyrae) upon some small pelagic fish larvae (*Engraulis encrasicolus*). *Small pelagics are the principal source of revenue for the local fisheries.* A social-ecological model was created in order to capture the effects of changes in abundance of *Pelagia noctiluca* upon the local fisheries, the tourist industry and the wider economy. The following sub-models were constructed and connected following the systems approach framework methodology: an

age-class based fisheries model; a jellyfish population matrix model; a jellyfish stranding model; a study on the impact of jellyfish strandings on beach users; and an economic input-output matrix. Various future scenarios for different abundances of jellyfish blooms were run. The “Expected blooms” scenario is similar to the quantity and size of blooms for 2000-2010. For a hypothetical “No blooms” scenario (standard background level of jellyfish but without any blooms) landings would increase by around 294 tonnes (5.1%) per year (averaged over 10 years) or approximately 0.19 M€ in profits per year (4.5 %), and strandings would decrease by 49%. In a “Frequent blooms” scenario, landings would decrease by around 147 tonnes per year (2.5%) and decrease profits by 0.10 M€ per year (2.3%), and strandings would increase by 32%. Given the changes that these scenarios would cause on the regional gross domestic product and employment, this study concludes that the overall impact of either of these scenarios on the economy would not be significant at the regional scale.

### Graphical Abstract:



### Highlights:

- We model the economic impacts of *Pelagia noctiluca* on small pelagic fisheries and beach users
- The impact of an increase in *Pelagia noctiluca* on small pelagic fisheries in Catalonia is low
- The impact of an increase in *Pelagia noctiluca* on tourism in Catalonia is low
- The impact of an increase in *Pelagia noctiluca* would not be significant at the regional scale

**Keywords:**

Pelagia noctiluca; Anchovy; Sardine; Small pelagic fisheries; Social-ecosystem model; Jellyfish strandings

Regional terms: Mediterranean, Spain, Catalonia

**1 Introduction**

Jellyfish occur naturally in the coastal waters of Catalonia in the North Western Mediterranean Sea (Calvo et al., 2011; Condon et al., 2012; Gili et al., 1988; Goy et al., 1989). Despite the widespread perception that their numbers are increasing (Canepa et al., 2013), there is a lack of long term observations to confirm this hypothesis (Pauly et al., 2009; Purcell et al., 2007). Speculation regarding this possible long term increase has been attributed to climate change, over-fishing of predators and competitors, eutrophication, habitat modification (creating more habitats for polyps), and introduction of non-native species (translocation via ballast water or ship hulls) (Canepa et al., 2013; Duarte et al., 2013; Purcell et al., 2007; Richardson et al., 2009).

There is concern among academics, managers and the general public (Canepa et al., 2013) that an increase in jellyfish bloom frequency will have a detrimental effect on a number of economic sectors, including but not limited to, fisheries and tourism. In many cases around the world, stranding events of jellyfish reduce the recreational appeal of beaches and bathing waters for beach users being detrimental for the local tourist industry (Purcell et al., 2007; Richardson et al., 2009). In this context, jellyfish outbreaks can be conceived of as an event that potentially diminish the benefit humans receive from marine and coastal ecosystem services (Daily, 2003; Hassan et al., 2005; Hattam et al., 2015), particularly cultural services (e.g. tourism and recreation) (De Donno et al., 2014; Ghermandi et al., 2015; Kontogianni and Emmanouilides, 2014; Nunes et al., 2015; Palmieri et al., 2015) and provisioning services (e.g. seafood) (Angel et al., 2014; Conley and Sutherland, 2015; Graham et al., 2003; Nastav et al., 2013; Palmieri et al., 2014).

Cultural and provisioning services valuation is already robustly backed up in theoretical and empirical terms, by a large number of case studies around the world (Brenner et al., 2010; de Groot et al., 2002; Farber et al., 2002; Heal, 2000). There is a lack of studies regarding changes in the delivery of ecosystem services both in the presence and absence of jellyfish outbreaks though. Our work proposes to assess the impact of these changes, specifically on the tourism and seafood producing industries in Catalonia, under different future scenarios of jellyfish outbreaks, with models parameterized based on data corresponding to the past 15 years.

In Catalonia, beach-based, sun-and-sand tourism and fisheries are the main uses of the coastal zone (Sardá et al., 2005). For instance, tourism revenues are increasing and are currently around €14 billion per year with around 16 million visitors (IDESCAT, 2010), with the majority resulting from “sun and beach” tourism (Ariza et al., 2008). Increasing jellyfish blooms result in beach strandings that may be visually unpleasing to beach users or actually detrimental to human health (Ghermandi et al., 2015).

The contribution of fisheries to the coastal economic is much lower and declining, with a production value (at first sale) of ca. €110 million per year (IDESCAT, 2010). Jellyfish are thought to impact fisheries by feeding on fish larvae (Purcell et al., 2014, 1994; Purcell and Arai, 2001; Sabatés et al., 2010) as well as competing with adults for food (Purcell and Arai, 2001; Purcell and Grover, 1990). Fisheries along the Catalan coast largely consist of semi-industrial and artisanal fleets with the main contributors to landings being the small pelagics sardine (*Sardina pilchardus*) and anchovy (*Engraulis encrasicolus*), which account for around 50% of total annual landings in weight and 25% in economic value (IDESCAT, 2010; Lleonart and Maynou, 2003; Palomera et al., 2007).

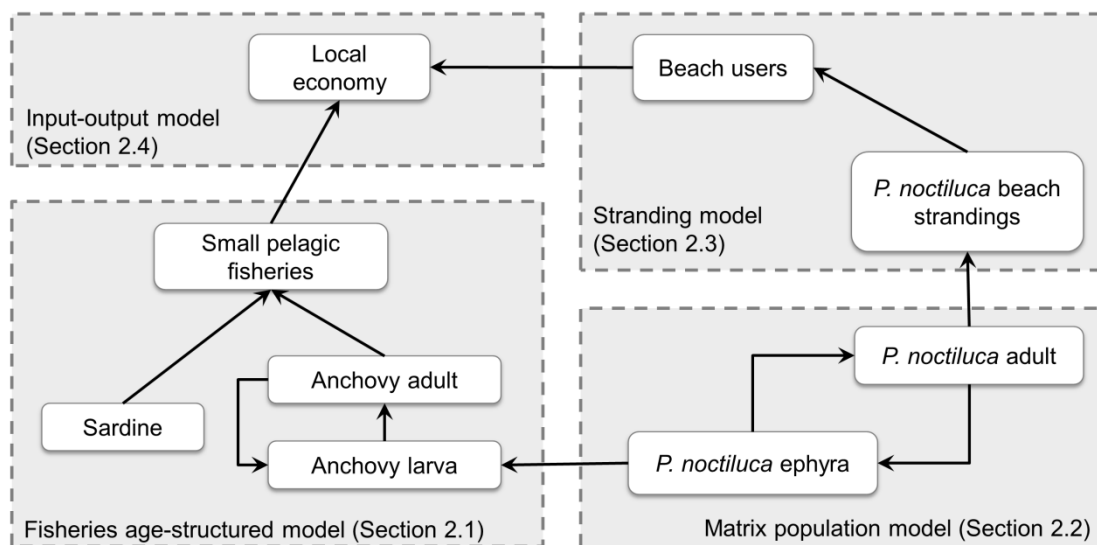
This study proposes an integrated approach to the analysis of the impact of jellyfish blooms on the key sectors of tourism and fisheries. The modelling dimension of the Systems Approach Framework (Hopkins et al., 2011; Tomlinson et al., 2011) was undertaken in which the ecological and socio-economic components are defined, modelled and linked together. Future possible scenarios were run

for various intensities of jellyfish blooms, and the impact that they would have on the local tourism and fisheries economy was estimated, in order to contribute to a partial evaluation of the consumer surplus of marine ecosystems free of abnormally high jellyfish outbreaks.

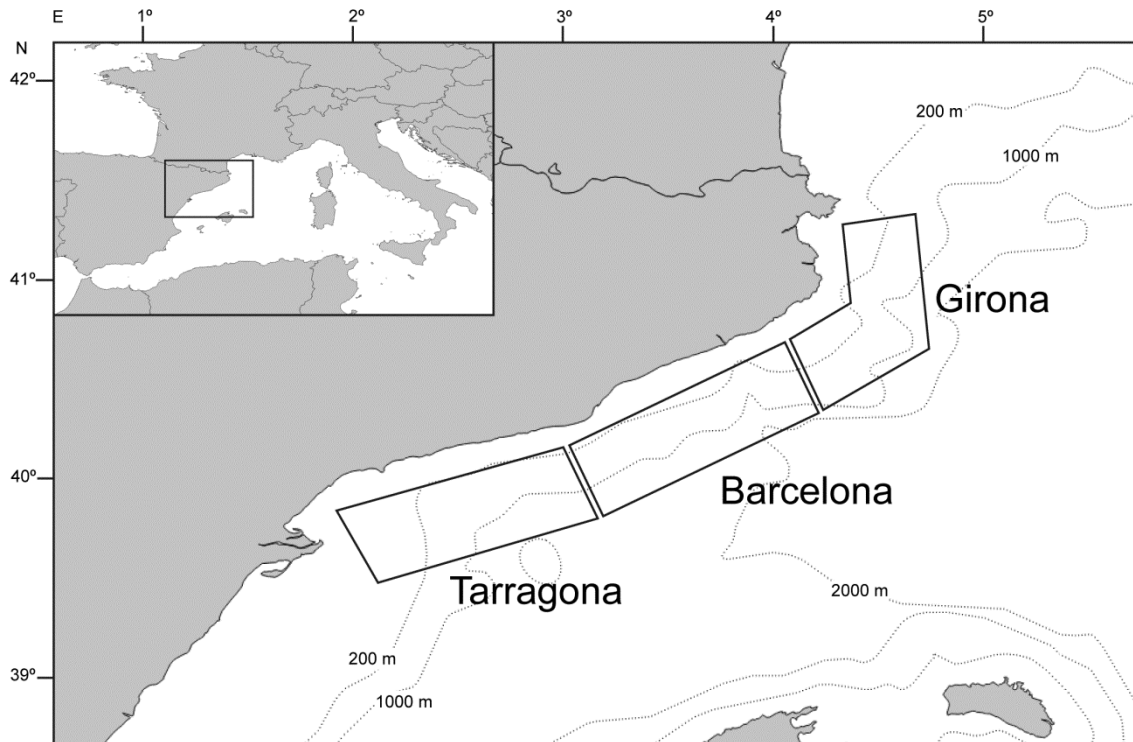
## 2 Material and methods

A model was constructed using the software ExtendSim. Various sub-models were constructed using different techniques and methodologies as outlined below. A simplified approximation of the overall model is shown in Figure 1, indicating how each sub-model is connected within it. Spatially, the model is divided into three zones representing approximately equal areas of the Catalan Sea. Each zone extends from the coastline to the shelf break - the area where most of the small-pelagic fishing activity and jellyfish occur. The zones cover the area heading south from Cap de Creus to the Ebro Delta and are named after the adjacent provinces: Girona; Barcelona; and Tarragona (Figure 2). Cap de Creus and Ebro Delta are not included in the study area due to the differing fisheries practiced there. In this study, we refer to all three zones together as “Catalonia” but it should be remembered that this does not include the entire administrative region of Catalonia.

[Figure 1: Conceptual model]



[Figure 2: Location of the three study zones]



The model examines the impact of one species of jellyfish, *Pelagia noctiluca*, because it is one of the most abundant in the study zone, has a powerful sting (affecting beach users), and is relatively well studied and documented (Canepa et al., 2014), particularly its predation effects on small pelagic larvae (Purcell et al., 2014; Sabatés et al., 2010). Although many other species of scyphomedusae have been found in the study zone, there is no evidence to suggest that they prey upon fish larvae and so have been excluded from the model.

## 2.1 Fisheries sub-model

The fisheries sub-model was based on a simplified and adapted version of the MEFISTO model. MEFISTO (MEDiterranean FISheries Simulation TOol) is an age-structured bio-economic model which is multi-species, multi-fleet, within a single predefined zone, where the central management lever is effort limitation. The MEFISTO model has been applied in various analyses including red

shrimp, hake, anchovy and sardine fisheries within the Mediterranean and is fully documented and available to download and use (Lleonart et al., 2003, 1998; Maynou et al., 2006).

For this analysis, the model was adapted in order to capture the predation of jellyfish upon the small pelagics larvae. The MEFISTO model runs at a time-step of one year so all the forecasts of fish mortality, growth, biomass, catches and recruitment are aggregated over the year. Given that anchovy and sardine larvae only occur in the plankton at specific times of the year (summer and winter respectively), in order to ascertain the impact of *Pelagia noctiluca* predation upon these fisheries, the resolution of the model was increased to a time-step of one month, in order to capture this temporally specific interaction. The forecast was run for a period of 120 months (10 years).

The MEFISTO model aggregates the fisheries dynamics over one spatial zone, but in order to capture the various degrees of jellyfish strandings upon different Catalan beaches, a greater spatial resolution was needed. Previous information has shown that the degree of jellyfish strandings can largely be divided into three zones, where the north of Catalonia (Girona) receives a high number of strandings, central Catalonia (Barcelona) receives low strandings, and south Catalonia (Tarragona) receives a medium level (Canepa et al., 2014). Therefore, the spatial resolution was adapted to reflect this, and three zones were used.

Given that principal objective of the analysis is to capture the interaction of jellyfish with small pelagics and not the dynamics of resource allocation within the fisheries themselves, a number of the MEFISTO model elements were simplified: Effort and catchability were fixed; there were no bycatches or discards; all stochastic elements were removed; the market and fishermen components (described as “boxes” in (Lleonart et al., 2003)) were left static (i.e. fish prices are fixed and there is no reinvestment in vessels or bank loans).

The majority of the equations for the biological sub-model are typical to all age-structured models and have been fully documented elsewhere so they are not reproduced here (Lleonart et al., 2003, 1998).



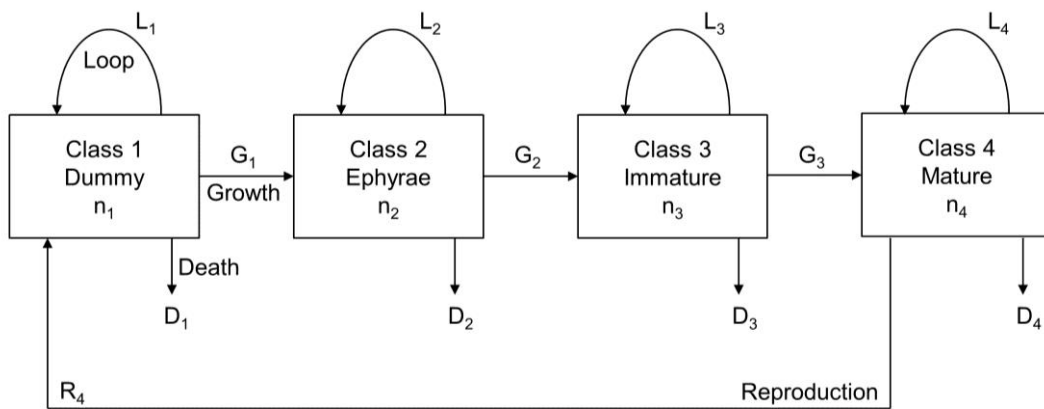
An exception to this is the recruitment sub-model. In MEFISTO and other age-structured models, recruits are generally calculated by using one of three equations: constant recruitment, Beverton and Holt's model; or Ricker's model. This calculates the number of recruits to the following year's cohort at age 0. For our analysis, this is not sufficient because we want to analyze the impact of *Pelagia noctiluca* when it preys upon the larvae of the small pelagics. In our age-structured model, the fish are assumed to be larvae only during their "Age 0" time-step (i.e. for the first month of their life (Palomera et al., 2007)), after which they become classed as "juveniles". After 6 months or older, they then become susceptible to fishing mortality. Incorporation of larvae to fish population is therefore calculated using the fecundity rate of anchovy (Mantzouni et al., 2007) and sardine (Froese and Pauly, 2014) for a given age (in years), multiplied by a monthly spawning factor. The monthly spawning factor elicited from previous studies (García and Palomera, 1996; Olivar et al., 2003; Palomera, 1992) ensures that each species only spawns in the relevant months (winter for sardine, summer for anchovy). This function of larvae recruitment to the environment was then adjusted to data specific to the study zone (García and Palomera, 1996; Martín et al., 2008; Olivar et al., 2003; Palomera, 1992; Sabatés et al., 2013, 2007).

Fish growth parameters were calculated as an average from 2002-2009 for the Northern Spain geographical sub-area (GSA06) (Cardinale et al., 2010). Maturity, natural mortality and fishing mortality rates (also for GSA06) were extrapolated from an annual to monthly value (Cardinale et al., 2010) with the following exceptions: There is zero fishing mortality for the first six months for both anchovy and sardine; and the natural mortality of larvae (Age 0) was taken from the literature (Mantzouni et al., 2007; Palomera and Lleonart, 1989; Pertierra et al., 1997; Romanelli et al., 2002). Initial population levels for each species for each zone were calculated from extracting landings data for each zone (IDESCAT, 2010) from the entire GSA06 (Cardinale et al., 2010) for 2002-2009. Fleet, vessel and market parameters were taken for 2010 and specific to each zone (Anderson and Carvalho, 2013; Cardinale et al., 2010).

## 2.2 *Pelagia noctiluca* sub-model

In order to model the dynamics of *Pelagia noctiluca*, a matrix population model was constructed using the inverse method for time series and the parameters were estimated using multiple regression (Caswell, 2006). Previous attempts to construct *Pelagia noctiluca* matrix population models were based on size classes, rather than age classes, using a modified Leslie matrix and a time series for data from the Adriatic Sea (Malej and Malej Jr., 2004; Malej and Malej, 1992), with a time-step of one month. Their matrix model consisted of five size classes, the smallest of which was for both ephyra and early development stages (including the egg / planula larvae stage). For our analysis, it was necessary to separate between ephyra and other stages as this is the predominant stage which feeds on fish larvae, so a different matrix was constructed using four classes as shown graphically in Figure 3, and mathematically in Figure 4.

[Figure 3: Graphical presentation of the *Pelagia noctiluca* matrix population model]



[Figure 4: Projection Matrix of the *Pelagia noctiluca* matrix population model]

$$M \quad \times \quad n_t = n_{t+1}$$

$$\begin{bmatrix} L_1 & 0 & 0 & R_4 \\ G_1 & L_2 & 0 & 0 \\ 0 & G_2 & L_3 & 0 \\ 0 & 0 & G_3 & L_4 \end{bmatrix} \begin{bmatrix} n_{1t} \\ n_{2t} \\ n_{3t} \\ n_{4t} \end{bmatrix} = \begin{bmatrix} n_{1t+1} \\ n_{2t+1} \\ n_{3t+1} \\ n_{4t+1} \end{bmatrix}$$

Construction of matrix population models using time series is data intensive, requiring size-frequency distributions throughout (at least) a year. This high resolution data does not exist for the study zone so data was sought from an area with similar conditions. Size frequency distributions data were taken from a study from the Straits of Messina (Central Mediterranean) collected monthly from January 2008 until August 2011 (Rosa et al., 2013), and the matrix was constructed using least squares regression to estimate all the parameters except for reproduction ( $R_4$  in Figure 4) as described by Caswell (2006). *Pelagia noctiluca* can reproduce throughout the year, producing oocytes in different development stages with peaks in spring and autumn (Rottini-Sandrini and Avian, 1991), although gonad maturation and spawning generally occur during the winter and spring (Malej and Malej Jr., 2004). In our model, the eggs/planulae class is a dummy variable class, and should not be considered as the actual population of either eggs or planulae. It is used as a placeholder between the mature adults and ephyrae. So for our model, reproduction ( $R_4$ ) of class 4 ( $n_4$ ) to class 1 ( $n_1$ ) occurs only during the winter season, from October until January. These temporal distinctions were reflected by alternating matrices depending on the month.  $R_4$  was calculated using an optimization algorithm to create a stable cyclical dynamic population. The final population matrices are shown in Figure 5.

[Figure 5: Projection Matrix with parameters]

$$\text{February – September: } \begin{bmatrix} 0.350 & 0 & 0 & 0 \\ 0.298 & 0.650 & 0 & 0 \\ 0 & 0.003 & 0.201 & 0 \\ 0 & 0 & 0.498 & 0.418 \end{bmatrix}$$

$$\text{October – January: } \begin{bmatrix} 0.350 & 0 & 0 & 2436 \\ 0.298 & 0.650 & 0 & 0 \\ 0 & 0.003 & 0.201 & 0 \\ 0 & 0 & 0.498 & 0.418 \end{bmatrix}$$

The model simulation begins in January when there is a lack of *Pelagia noctiluca* population data in the study zone. Therefore in order to initialize the population of the jellyfish matrix, values were chosen for class 1 (dummy) and class 2 (ephyrae) that would reproduce values approximately

equivalent to the available data in June-July for classes 2 (ephyrae), 3 (immature adults) and 4 (mature adults), for each of the study zones (Sabatés et al., 2010).

There have long been strong fluctuations in the inter-annual population of *Pelagia noctiluca* in the Western Mediterranean (Bernard et al., 2011; Brotz and Pauly, 2012; Goy et al., 1989) which are notoriously difficult to predict (Brotz and Pauly, 2012; Rosa et al., 2013). Given the uncertainties involved in the underlying causes of these fluctuations, the model produces a “background” level of *Pelagia noctiluca*, which is based on the minimum populations that usually occur. The model user has the capability to create proliferation events or blooms as a specific event for a given time and given magnitude. This would allow the model to run various scenarios based on blooms with various frequencies and magnitudes, and examine the effect this would have on fisheries and tourism.

Dietary analysis of *P. noctiluca* ephyrae collected in the shelf-slope region of the Catalan Sea in June, when both the abundance of anchovy larvae and *P. noctiluca* is high revealed that from 4400 ephyrae examined there were 26 incidences of recently consumed fish larvae representing up to 12% of the total prey captured by young jellyfish (Sabatés et al., 2010). Given a 3 hour larval digestion time (Purcell et al., 2014) and taking into account that the highest level of predation on fish larvae takes place during the night (Sabatés et al., 2010), a period of 12 hours per day was considered for calculations. This equates to a feeding rate of *P. noctiluca* on fish larvae of 0.709 per month. 38% of the fish larvae consumed were *Engraulis encrasicolus*, so a best estimate (used in the model) of the consumption rate of anchovy larvae by an individual *P. noctiluca* ephyra per month is 0.269. There is no data available regarding the predation rate of *P. noctiluca* (or other jellyfish) on sardine.

### **2.3 Stranding model**

The arrival of jellyfish to the coastal beaches of Catalonia is a complex process which depends on many factors including the offshore production of blooms typically caused by mild winters, low rainfall and high temperatures. Oceanographic structures such as fronts can reduce the likelihood of

jellyfish arriving to the beaches, but when they are weakened, southeast winds can force the jellyfish towards the coast and become present in the bathing waters and strand on the beaches (Canepa et al., 2014). The prediction of such events is therefore complex given the multiple factors that can influence such conditions.

The timestep of the model is monthly which is unable to capture the sporadic daily conditions that influence the weakening of the front and necessary wind forcing which could improve prediction of strandings. Therefore it was decided that an overall estimate of strandings should be based on a comparison of historic stranding events compared to jellyfish population in the coastal waters. A more robust model should include the possibility of including the previously mentioned meteorological factors but there is currently insufficient data available.

Data for strandings of *Pelagia noctiluca* was made available by a cooperation between the Marine Science Institute (CSIC), Barcelona and the regional water authority (Agència Catalana de l'Aigua) for the years 2007-2010 during the summer months (May to September). Girona has the most number of stranding events, with the majority occurring (in all zones) in June. A “stranding event” is defined as where one of the beaches within the zone has at least one stranding. This data was compared with the expected number of *P. noctiluca* adults (immature and mature) within the coastal water to create an average stranding rate per month, averaged over all zones.

There are three types of stranding events depending on the density of the jellyfish. “Type 1” has less than ten individuals per beach. “Type 2” has between 10 individuals per beach and less than 1 individual  $m^{-2}$ , and “Type 3” has a density greater than 1  $m^{-2}$  (Canepa et al., 2014).

Research undertaken by Nunes et al. (2015) was used to assess the impact of jellyfish strandings on beach users in Catalonia. They used a stated-choice questionnaire and a Random Utility Model to estimate the quantified tourism losses caused by the presence of jellyfish at the beach. During the summer of 2012, 644 questionnaires were completed by beach users in eight Catalan beaches to elicit

preferences regarding the following attributes of a given beach: (1) risk of presence of jellyfish, (2) beach water quality, (3) infrastructure and amenities, (4) additional travel time to reach the beach being considered (Nunes et al., 2015). Nunes et al. (2015) calculated the consumptive value of travel time using a random parameters model as approximately 25 minutes. Respondents were found to be willing to travel an additional 3.81 minutes more per trip to go to a beach with a jellyfish presence of less than two days a week rather than one with more than five days a week (the 95% confidence interval is between 2.066 and 5.553 minutes). Taking into account only the subsample of those that made a trade-off between various beach attributes (approximately 50% of respondents), and given the average household income per hour was €19.23 for 2012, individuals are willing to pay on average €3.20 to visit a beach with lower risk of jellyfish presence (Nunes et al., 2015).

## **2.4 Input-Output model**

Increases in *P. noctiluca* blooms have a direct economic impact on both fisheries and tourism. However there will also be indirect economic impacts on the wider regional economy through inter-industry relationships which can be calculated using input-output matrix analysis. This is a standard econometric technique which uses certain assumptions to define a matrix of inter-industry transactions and calculate the quantity purchased by a given industry from all other industries (Common and Stagl, 2005; Perman et al., 2011), and is published by most developed countries as part of their national accounts. Although there exists a range of possible methodologies to measure the economic impact of a specific industry on the whole economy (simplistic economic models, complex general equilibrium models), an input-output analysis is computationally less complicated once the data has been collected and the tables have been constructed (Nastav et al., 2013). The input-output matrix is an accurate reflection of the year in which it was produced, and therefore any predictions using the multipliers are relevant only for the short term.

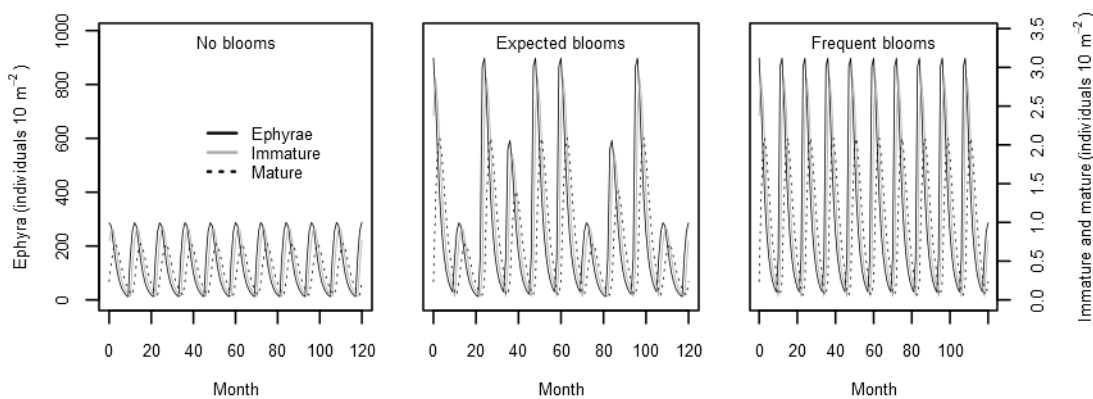
Input-output tables with 65 branches (or sectors), the (type I) inverse matrix and multipliers for Catalonia in 2005 published by the Institute of Statistics of Catalonia (IDESCAT, 2010) were used

for this analysis, which used the methodological standard set by the *System of National Accounts* (EC et al., 2009). According to their analysis, the “Production value” of fisheries for Catalonia is 1.348 which means for every 1 euro change in revenue, there will be a change in related industries of €1.348. The “Employment value” is 19.07 which means for a change in revenues of a million euros, employment would change by 19.07 people. “Production values” for tourism related sectors are higher (1.51 for hotels and other accommodation; 1.48 for restaurants), but have a lower “Employment value” (16.54 for hotels and other accommodation; 13.92 for restaurants) than for fisheries. This means that for a given change in revenues for fisheries, the same change in revenues for sectors related to tourism (hotels and restaurants) will have a greater effect on the regional GDP, but will have less of an effect on regional employment.

### 3 Results

Three ten-year forecast scenarios were run for varying levels of *P. noctiluca* blooms as shown in Figure 6. The “No blooms” scenario is the minimum level of *P. noctiluca* that will always be present in the coastal waters. The “Expected blooms” scenario is based on historical jellyfish observations from 2000-2010.

[Figure 6: Concentration of *P. noctiluca* in Catalonia for various scenarios]

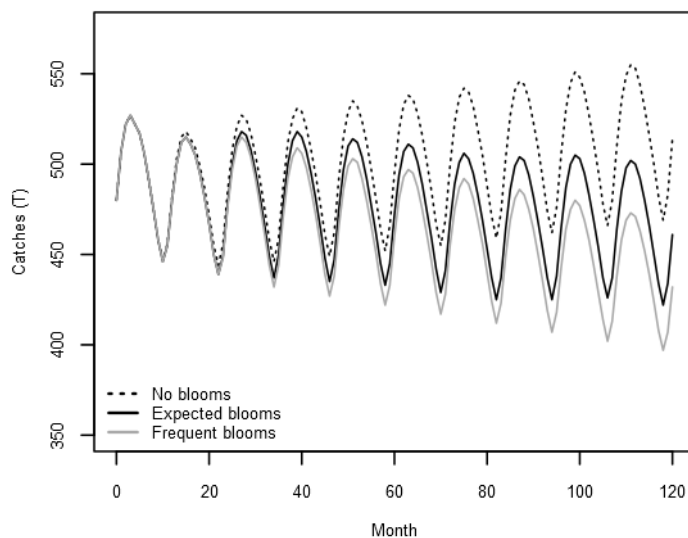


The maximum observed value from this ten-year historic data set was then applied every year as shown in the “Frequent blooms” scenario. The blooms are applied equally over each study zone. It should be noted that both immature and mature *P. noctiluca* both contribute towards strandings, negatively affecting the recreational appeal of the beaches, whereas ephyrae do not.

### 3.1 Fisheries

Figure 7 shows the effect on anchovy catches over the 10 year forecast period under the three scenario conditions. As expected, increases in *P. noctiluca* blooms causes a reduction in catches. Comparing the *Expected blooms* scenario to the *No Blooms* scenario reveals there could be up to a 5.1 % increase in catches per year for Catalonia if there were fewer years with blooms. Conversely, an increase in blooms (under the *Frequent blooms* scenario) could decrease the catches by 2.6 % per year (Table 1). It can also be seen that this trend would continue to increase if a given scenario continued beyond the ten year forecast period, as indicated by comparing the average change over ten years with just the final year of the forecast period. The Barcelona zone appears to be the most influenced by changes in *P. noctiluca* blooms although the difference is minimal.

[Figure 7: Monthly catches of anchovy for Catalonia]



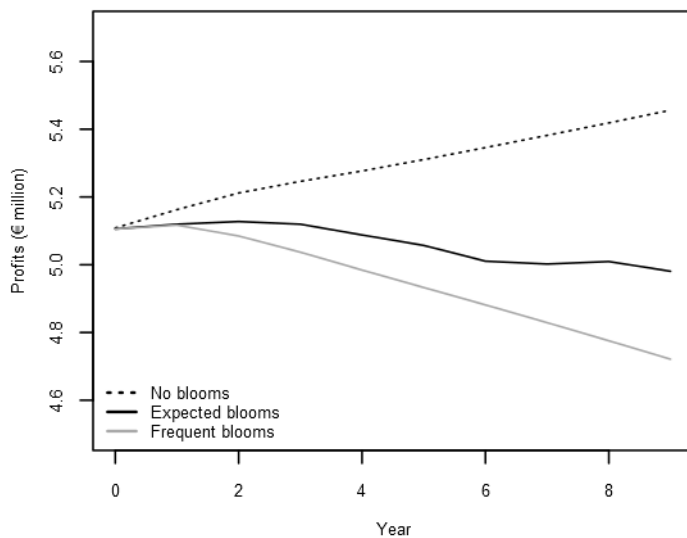


[Table 1: Change in yearly anchovy catches (T), comparing *Expected blooms* to other scenarios]

	No blooms		Frequent blooms	
	10 year average	Last year	10 year average	Last year
Tarragona	71 (4.2 %)	147 (8.8 %)	-35 (-2.1 %)	-80 (-4.8 %)
Barcelona	84 (5.7 %)	172 (12.2 %)	-42 (-2.9 %)	-94 (-6.7 %)
Girona	140 (5.3 %)	287 (11.3 %)	-70 (-2.7 %)	-157 (-6.2 %)
Catalonia (Total)	294 (5.1 %)	608 (10.8 %)	-147 (-2.6 %)	- 332 (-5.6 %)

Given the lack of data regarding the predation of *P. noctiluca* upon sardine larvae, the model produces no difference in the landing totals for sardine under the three scenarios. The impact that changes in anchovy landings have upon the small pelagic fisheries profits is shown in Figure 8. A comparison of *Expected blooms* and *No blooms* shows that profits could increase by 4.5% per year given fewer *P. noctiluca* blooms. Under the *Frequent blooms* scenario, there could be a loss in profits of around 2.3 % per year.

[Figure 8: Yearly profits of small pelagic fisheries for Catalonia]



### 3.2 Jellyfish stranding events

Table 2 shows a summary of the average yearly *P. noctiluca* stranding events for a 10 year forecast period. As expected, higher occurrences of blooms results in an increase in frequency and density of stranding events. There is a 49% decrease of stranding events for Catalonia comparing the *Expected blooms* scenario to the *No blooms* scenario. Conversely, there is a 33% increase in stranding events when the blooms increase from the *Expected blooms* to *Frequent blooms* scenario.

[Table 2: Average stranding events per year of *P. noctiluca* for each scenario over 10 year forecast period]

Zone	No blooms			Expected blooms			Frequent blooms		
	Type 1 < 10 per beach	Type 2 < 1 m <sup>-2</sup>	Type 3 > 1 m <sup>-2</sup>	Type 1 < 10 per beach	Type 2 < 1 m <sup>-2</sup>	Type 3 > 1 m <sup>-2</sup>	Type 1 < 10 per beach	Type 2 < 1 m <sup>-2</sup>	Type 3 > 1 m <sup>-2</sup>
Tarragona	24	3	1	47	6	2	63	8	3
Barcelona	29	4	1	57	7	3	75	9	4
Girona	48	6	2	95	12	5	125	16	6
Catalonia	102	13	5	199	25	10	263	33	13

Despite the potential increases in *P. noctiluca* stranding events, they still do not meet the threshold in which beach users would choose to travel further to avoid the stranded jellyfish. Nunes et al. (2015) conclude that beach users are willing to each pay €3.20 more per visit to travel from a beach which has more than five stranding events per week to one which has just one or two events. The maximum number of stranding events per month is 55 in the Girona zone in June during the *Frequent blooms* scenario. Given that there are 71 beaches in this zone, this averages less than 0.2 stranding events per beach per week, far from the threshold which would induce beach users to avoid such a beach. Therefore according to these results, the impact of *P. noctiluca* stranding events on tourism under all scenarios is zero.

### 3.3 Regional economy – Gross domestic product (GDP) and employment

Changes in revenues, whether it is in tourism, fisheries or any other industry will have a knock-on effect on other sectors whereby more or less demand is created for goods or services for that industry. The overall effect on the regional economy of the various scenarios for changes in the small-pelagic fisheries revenues is shown in Table 3. Given that the threshold for *P. noctiluca* strandings is not reached, the overall impact on tourism and the regional economy is zero and not included in this table. When compared to the *Expected blooms* scenario, the impact of changes in blooms to the regional economy is relatively insignificant when compared to the regional GDP and employment.

[Table 3: Changes to regional economy with comparison to regional economy]

Scenario	Average yearly revenue (10 year forecast period) (€)	Change in revenue* (€)	Change in regional economy* (€)	Change in regional employment* (individuals)
Expected blooms	20,674,929	-	-	-
No blooms	21,150,777	475,848 (102%*)	641,444 (<0.001% of reg. GDP)	12 (0.3% fishing sector)
Frequent blooms	20,436,377	-238,552 (99%*)	-321,568 (<0.001% of reg. GDP)	-6 (-0.1% fishing sector)

2010 GDP of regional economy €143,000 million.

2010 Employment in fishing sector is 4183

\*compared to “Expected blooms”

## 4. Discussion

Before discussing the overall impact of changes in *Pelagia noctiluca* blooms on fisheries, tourism and the regional economy in Catalonia, we should acknowledge the limitations in both the scarcity of available data and knowledge as well as the drawbacks to the modelling methodology used.

The predation rate used in the model of *P. noctiluca* on anchovy was taken from a research cruise conducted in June 1995 and examined only ephyrae and not adults (Sabatés et al., 2010), while there is no information on predation for sardine. Previous studies suggest that *P. noctiluca* is an opportunistic non-selective predator that prey on what it encounters rather than actively hunt target

species (Malej, 1989). A problem of large aggregated zones such as those used in the model, limit the ability to predict the consequences when dense quantities of predator and prey coincide temporally and spatially. Other studies have suggested that the effects could be greater than the results of our model (Purcell et al., 2014). Given that *P. noctiluca* may prey on larvae of different fish species, not only anchovy larvae, an exploratory scenario was run where the same predation rate for anchovy was used for sardine. However, within the model, this decimates the sardine population within a few years so clearly the predation rate has to be less. This could be due to a number of factors such as greater availability of other planktonic prey, or that they do not coincide spatially. It is important to note that sardine larvae are found in the plankton in winter, when the abundance of *P. noctiluca* is much lower than in summer but that of other planktonic organisms, such as copepods, is higher (Fernández de Puelles et al., 2007).

There are many physical, physicochemical, biological and climatic forcings which influence changes in population and migration of *P. noctiluca* (Canepa et al., 2014) which are omitted from this model due to incomplete data and knowledge. Once these data gaps have been completed and these interactions better understood they can be incorporated into this model, until then there have been many simplifications. The initial population value within the jellyfish population matrix dictates the population for its following growth, death and reproduction cycle, therefore it is crucial that an accurate value is used. However, given that the sampled populations of *P. noctiluca* vary by many orders of magnitude, it is difficult to estimate an average value for a given time and zone. The various bloom scenarios (based on all species of jellyfish sightings) try to capture some of this uncertainty where sightings change by up to a factor of five year-on-year, however these changes are small when compared to the variance in initial conditions which is based on recorded samples. Due to a scarcity of data, modelled blooms occur proportionally equally to each zone, however it is likely that this is not the real situation. Further data could improve this simplification. Although the model permits migration of jellyfish from one zone to another and is thought to occur, the data is limited and therefore omitted from the current scenario analysis.

As previously described, the jellyfish stranding model is based on historic aggregated data and cannot model the complex factors involved in accurately predicting such events at the required temporal and spatial resolution. As knowledge further develops towards understanding these processes, this sub-model should be updated to include and improve upon its predictive capacity. The effect of strandings on beach users is based on a stated-choice experiment to elicit the willingness to pay to avoid beaches with jellyfish (Nunes et al., 2015). Within the study, the alternative option is to travel to another nearby beach (without jellyfish) and calculate the costs involved. Although the costs to the beach and nearby businesses would be negative, the overall change to the regional economy would be zero. A currently unexplored scenario with potentially greater negative impact to the Catalan economy would be if the jellyfish strandings problem became such a continual problem that beach users chose to visit or stay in other regions or countries. The few studies which have directly investigated public perception conclude that providing information to beach users could increase acceptance of jellyfish in the bathing waters (Baumann and Schernewski, 2012; Vandendriessche et al., 2013).

Given these caveats, the results of the various scenarios show that *P. noctiluca* has a low impact on small pelagic fisheries, tourism and the regional economy in Catalonia. The standard deviation of recorded year-to-year anchovy landings (1329 tonnes over the last 5 years) is larger than the standard deviation of the most contrasting modelled scenarios (311 tonnes when comparing *No blooms* to *Frequent blooms*).

As previously described, the effect of the strandings on the tourists is zero within our analysis but this is partly a result of the aggregated spatial dimension of the model. The model cannot determine if the strandings occur in specific beaches in a given zone. If this were the case, then the number of stranding events could be sufficient to influence a beach user's decision to visit another beach with fewer jellyfish. It should also be remembered that this study models the stranding of *P. noctiluca*. It is possible that *P. noctiluca* will strand with other species of jellyfish and reach the threshold in which the beach users choose to visit a different beach.

The impact on the regional economy is limited with just a small effect on the fisheries industry. The much larger tourism industry has the potential to more severely affect the regional economy given its relative size compared to fisheries as well as its potential effect on dependent industries (i.e a larger production value from the input-output matrix).

Our model could be seen as a contribution to the partial evaluation of the user's surplus of marine ecosystems free of jellyfish outbreaks. Users (local fishers / tourists) would benefit to some extent from good ecosystem health, because even if the global estimated *relative* impact is low, in absolute terms the impact is estimated at a maximum of €1 million (the difference between the *No blooms* and *Frequent blooms* scenarios). This amount would not justify public investment on information and mitigation campaigns to partially offset the welfare losses from abnormally high jellyfish outbreaks. Despite these results, it should be remembered that this study only reflects the impact of just one species of jellyfish in an area where there exist 12 species of scyphomedusae (Canepa et al., 2014). Many studies suggest that the occurrence of jellyfish blooms is increasing for many species, therefore the combined effect with other jellyfish on predation of small pelagics, beach stranding events and the effect on beach users would have a greater impact than the various scenario results presented here (Nunes et al., 2015).

There are relatively few studies which try to quantify the economic impact of jellyfish on socio-economic systems (Ghermandi et al., 2015; Nastav et al., 2013; Palmieri et al., 2014). Nunes et al. (2015) estimate that beach users are willing to pay an additional €3.20 per trip to visit beaches with fewer jellyfish which is equivalent to €423 million/year for the whole of the Catalonia. Ghermandi et al. (2015) estimate that there could be an annual loss of €1.8-6.2 million due to fewer seaside visits caused by jellyfish outbreaks in Israel. Kontogianni & Emmanouilides (2014) estimate that households in the Gulf of Lion are willing-to-pay on average €66 (single payment) to reduce expected jellyfish outbreaks from 9 years per decade to 1 year per decade. In a survey completed by fishers in Oregon, it was estimated that the economic impact to salmon and pink shrimp fishers was over \$650 000 in 2012 (Conley and Sutherland, 2015). Clogging of shrimp nets in Louisiana by jellyfish was

estimated to have cost millions of dollars in economic losses (Graham et al., 2003). Nastav et al. (2013) conclude that jellyfish presence had an impact on Slovenian fisheries, reducing catches, income and employment but do not quantify the losses. Nastav et al. (2013) also conclude that, similarly to this study, the effect on the regional economy was low.

The potential for welfare losses caused by jellyfish outbreaks are clearly large, but difficult to directly measure. Revealed preference methods have begun to quantify these risks, but further research is needed to ascertain the full economic impact of jellyfish blooms. To our knowledge, this is the first study which attempts to quantify the economic impact of jellyfish on both fisheries (predation of fish larvae) and the tourism industry (strandings), as well as the wider effects on the regional economy. The methodology can be applied to other jellyfish species (in Catalonia) to improve the results for this study zone as well as be applied to other regions or countries. Our minimum realistic model can be complemented with other less-well documented effects that have also an impact on welfare losses from jellyfish outbreaks, such as clogging cooling water intake pipes of power plants and desalination plants, clogging fishing nets or impairing fish production in fish farms (Conley and Sutherland, 2015; Ghermandi et al., 2015; Graham et al., 2003).

### **Acknowledgements**

This research was made possible by funding made available through the European Commission's Seventh Framework Programme (FP7-KBBE, 2007–2013) for the project “Vectors of Change in Oceans and Seas Marine Life, Impact on Economic Sectors” (VECTORS) - project reference 266445; the European Union ENPI CBC Mediterranean Sea Basin Programme for the project MED-JELLYRISK – project reference I-A/1.3/098; and the Spanish project FISHJELLY (MAR-CTM2010-18875). We wish to thank all the participants of these projects that made insightful comments and criticisms to research undertaken in this study. We also thank Tracey Saxby from the Integration and Application Network, University of Maryland Center for Environmental Science for the use of the purse seine boat and beach chair images in the graphical abstract ([ian.umces.edu/imagelibrary/](http://ian.umces.edu/imagelibrary/)).

## References

- Anderson, J., Carvalho, N., 2013. Scientific, Technical and Economic Committee for Fisheries (STECF) – The 2013 Annual Economic Report on the EU Fishing Fleet (STECF-13-15). Luxembourg. doi:10.2788/23331
- Angel, D.L., Edelist, D., Freeman, S., 2014. Local perspectives on regional challenges: jellyfish proliferation and fish stock management along the Israeli Mediterranean coast. *Reg. Environ. Chang.* doi:10.1007/s10113-014-0613-0
- Ariza, E., Jiménez, J.A., Sardá, R., 2008. A critical assessment of beach management on the Catalan coast. *Ocean Coast. Manag.* 51, 141–160. doi:10.1016/j.ocecoaman.2007.02.009
- Baumann, S., Schernewski, G., 2012. Occurrence and public perception of jellyfish along the German Baltic coastline. *J. Coast. Conserv.* 16, 555–566. doi:10.1007/s11852-012-0199-y
- Bernard, P., Berline, L., Gorsky, G., 2011. Long term (1981-2008) monitoring of the jellyfish *Pelagia noctiluca* (Cnidaria, Scyphozoa) on Mediterranean coasts (Principality of Monaco and French Riviera). *J. Oceanogr. Res. Data* 4, 1–10.
- Brenner, J., Jiménez, J.A., Sardá, R., Garola, A., 2010. An assessment of the non-market value of the ecosystem services provided by the Catalan coastal zone, Spain. *Ocean Coast. Manag.* 53, 27–38. doi:10.1016/j.ocecoaman.2009.10.008
- Brotz, L., Pauly, D., 2012. Jellyfish populations in the Mediterranean Sea. *Acta Adriat.* 53, 213–232.
- Calvo, E., Simó, R., Coma, R., Ribes, M., Pascual, J., Sabatés, a, Gili, J., Pelejero, C., 2011. Effects of climate change on Mediterranean marine ecosystems: the case of the Catalan Sea. *Clim. Res.* 50, 1–29. doi:10.3354/cr01040
- Canepa, A., Fuentes, V., Sabatés, A., Piraino, S., Boero, F., Gili, J.M., 2014. *Pelagia noctiluca* in the Mediterranean Sea, in: Pitt, K.A., Lucas, C.H. (Eds.), *Jellyfish Blooms*. Springer Dordrecht Heidelberg London New York, pp. 237–266.
- Canepa, A., Sastre, S., Piñol, L., Fuentes, V., 2013. Thirty years of jellyfish blooms in Catalonia: Narratives and empirical evidences, in: *Fourth International Jellyfish Bloom Symposium*. Hiroshima, Japan.
- Cardinale, M., Abella, A., Bellido, J., Biteto, I., Colloca, F., Fiorentino, F., Giannoulaki, M., Guijarro, B., Jadaud, A., Knittweis, L., Lloret, J., Martin, P., Murenu, M., Mustac, B., Osio, G.C., Quetglas, A., Quintanilla, F., Sbrana, M., Scarcella, G., Scott, F., Spedicato, M.T., Ticina, V., Tserpes, G., Tsikliras, A., Rätz, H.-J., Cheilari, A., 2010. Scientific, Technical and Economic Committee for Fisheries. Report of the SGMED-10-02 Working Group on the Mediterranean Part I. Luxembourg: Publications Office of the European Union. doi:10.2788/59974
- Caswell, H., 2006. *Matrix Population Models: Construction, Analysis and Interpretation*, 2nd Editio. ed. Sinauer Associates Inc., U.S.
- Common, M., Stagl, S., 2005. *Ecological Economics: An Introduction*. Cambridge University Press.
- Condon, R.H., Graham, W., Pitt, K., Cathy, H., 2012. Questioning the Rise of Gelatinous Zooplankton in the World's Oceans. *Bioscience* 62, 160–169. doi:10.1525/bio.2012.62.2.9



- Conley, K.R., Sutherland, K.R., 2015. Commercial fishers' perceptions of jellyfish interference in the Northern California Current. *ICES J. Mar. Sci.* doi:10.1093/icesjms/fsv007
- Daily, G., 2003. What are ecosystem services, in: *Global Environmental Challenges for the Twenty-First Century: Resources, Consumption and Sustainable Solutions*. pp. 227–231.
- De Donno, A., Idolo, A., Bagordo, F., Grassi, T., Leomanni, A., Serio, F., Guido, M., Canitano, M., Zampardi, S., Boero, F., Piraino, S., 2014. Impact of stinging jellyfish proliferations along south Italian coasts: Human health hazards, treatment and social costs. *Int. J. Environ. Res. Public Health* 11, 2488–2503. doi:10.3390/ijerph110302488
- De Groot, R.S., Wilson, M. a, Boumans, R.M., 2002. A typology for the classification, description and valuation of ecosystem functions, goods and services. *Ecol. Econ.* 41, 393–408. doi:10.1016/S0921-8009(02)00089-7
- Duarte, C.M., Pitt, K. a., Lucas, C.H., Purcell, J.E., Uye, S.I., Robinson, K., Brotz, L., Decker, M.B., Sutherland, K.R., Malej, A., Madin, L., Mianzan, H., Gili, J.M., Fuentes, V., Atienza, D., Pages, F., Breitburg, D., Malek, J., Graham, W.M., Condon, R.H., 2013. Is global ocean sprawl a cause of jellyfish blooms? *Front. Ecol. Environ.* 11, 91–97. doi:10.1890/110246
- EC, IMF, OECD, UN, Bank, W., 2009. *The System of National Accounts 2008*. New York. doi:10.1057/ukna.2008.3
- Farber, S.C., Costanza, R., Wilson, M. a., 2002. Economic and ecological concepts for valuing ecosystem services. *Ecol. Econ.* 41, 375–392. doi:10.1016/S0921-8009(02)00088-5
- Fernández de Puelles, M.L., Alemany, F., Jansá, J., 2007. Zooplankton time-series in the Balearic Sea (Western Mediterranean): Variability during the decade 1994–2003. *Prog. Oceanogr.* 74, 329–354. doi:10.1016/j.pocean.2007.04.009
- Froese, R., Pauly, D., 2014. FishBase version (11/2014) [WWW Document]. Fishbase. URL <http://www.fishbase.org/> (accessed 1.26.15).
- García, A., Palomera, I., 1996. Anchovy early life history and its relation to its surrounding environment in the Western Mediterranean basin. *Sci. Mar.* 60, 155–166.
- Ghermandi, A., Galil, B., Gowdy, J., Nunes, P. a. L.D., 2015. Jellyfish outbreak impacts on recreation in the Mediterranean Sea: welfare estimates from a socioeconomic pilot survey in Israel. *Ecosyst. Serv.* 11, 140–147. doi:10.1016/j.ecoser.2014.12.004
- Gili, J.M., Pages, F., Sabatés, A., Ros, J.D., 1988. Small-scale distribution of a cnidarian population in the western Mediterranean. *J. Plankton Res.* 10, 385–401. doi:10.1093/plankt/10.3.385
- Goy, J., Morand, P., Etienne, M., 1989. Long-term fluctuations of *Pelagia noctiluca* (Cnidaria, Scyphomedusa) in the western Mediterranean Sea. Prediction by climatic variables. *Deep Sea Res. Part A. Oceanogr. Res. Pap.* 36, 269–279. doi:10.1016/0198-0149(89)90138-6
- Graham, W.M., Martin, D.L., Felder, D.L., Asper, V.L., Perry, H.M., 2003. Ecological and economic implications of a tropical jellyfish invader in the Gulf of Mexico. *Biol. Invasions* 5, 53–69. doi:10.1023/A:1024046707234
- Hassan, R., Scholes, R., Ash, N., 2005. *Ecosystems and human well-being: current state and trends: findings of the Condition and Trends Working Group*.

- Hattam, C., Atkins, J.P., Beaumont, N., Börger, T., Böhnke-henrichs, A., Burdon, D., Groot, R. De, Hoefnagel, E., Nunes, P. a L.D., Piwowarczyk, J., Sastre, S., Austen, M.C., 2015. Marine ecosystem services: Linking indicators to their classification. *Ecol. Indic.* 49, 61–75. doi:10.1016/j.ecolind.2014.09.026
- Heal, G., 2000. Valuing Ecosystem Services. *Ecosystems* 3, 24–30. doi:10.1007/s100210000006
- Hopkins, T.S., Bailly, D., Støttrup, J.G., 2011. A Systems Approach Framework for Coastal Zones. *Ecol. Soc.* 16, 25. doi:http://dx.doi.org/10.5751/ES-04553-160425
- IDESCAT, 2010. Anuari estadístic de Catalunya. 2010. Institut d'Estadística de Catalunya.
- Kontogianni, A.D., Emmanouilides, C.J., 2014. The cost of a gelatinous future and loss of critical habitats in the Mediterranean. *ICES J. Mar. Sci.* 71, 853–866. doi:10.1093/icesjms/fst194
- Lleonart, J., Franquesa, R., Maynou, F., 1998. MEFISTO: Bio-Economic Model for Mediterranean Fisheries [WWW Document]. URL <http://www.mefisto.info/> (accessed 3.18.15).
- Lleonart, J., Maynou, F., 2003. Fish stock assessments in the Mediterranean: state of the art. *Sci. Mar.* 67, 37–49.
- Lleonart, J., Maynou, F., Recasens, L., Franquesa, R., 2003. A bioeconomic model for Mediterranean fisheries, the hake off Catalonia (western Mediterranean) as a case study. *Sci. Mar.* 67, 337–351.
- Malej, A., 1989. Behaviour and trophic ecology of the jellyfish *Pelagia noctiluca* (Forsskhil, 1775). *J. Exp. Mar. Bio. Ecol.* 126, 259–270. doi:http://dx.doi.org/10.1016/0022-0981(89)90191-3
- Malej, A., Malej Jr., A., 2004. Invasion of the Jellyfish *Pelagia noctiluca* in the Northern Adriatic. A non success story, in: Dumont, H.J., Shiganova, T.A., Niermann, U. (Eds.), *Aquatic Invasions in the Black, Caspian, and Mediterranean Seas*. p. pp 273–285.
- Malej, A., Malej, M., 1992. Population dynamics of the jellyfish *pelagia noctiluca*, in: Colombo, G., Ferrara, I. (Eds.), *Marine Eutrophication and Population Dynamics*. Olsen & Olsen, Freensborg, pp. 215–219.
- Mantzouni, I., Somarakis, S., Moutopoulos, D.K., Kallianiotis, A., Koutsikopoulos, C., 2007. Periodic, spatially structured matrix model for the study of anchovy (*Engraulis encrasicolus*) population dynamics in N Aegean Sea (E. Mediterranean). *Ecol. Modell.* 208, 367–377. doi:10.1016/j.ecolmodel.2007.05.021
- Martín, P., Bahamon, N., Sabatés, A., Maynou, F., Sánchez, P., Demestre, M., 2008. European anchovy (*Engraulis encrasicolus*) landings and environmental conditions on the Catalan Coast (NW Mediterranean) during 2000–2005. *Hydrobiologia* 612, 185–199. doi:10.1007/s10750-008-9482-1
- Maynou, F., Sardà, F., Tudela, S., Demestre, M., 2006. Management strategies for red shrimp (*Aristeus antennatus*) fisheries in the Catalan sea (NW Mediterranean) based on bioeconomic simulation analysis. *Aquat. Living Resour.* 19, 161–171. doi:DOI: 10.1051/alr:2006014
- Nastav, B., Malej, M., Malej, A., 2013. Is it possible to determine the economic impact of jellyfish outbreaks on fisheries? A case study - Slovenia. *Mediterr. Mar. Sci.* 14, 214–223. doi:10.12681/mms.382

- Nunes, P.A.L.D., Loureiro, M., Piñol, L., Sastre, S., 2015. Analyzing beach recreationists' preferences for the reduction of jellyfish blooms: Economic results from a stated-choice experiment in Catalonia, Spain. *PLoS One* 10, 1–34. doi:10.1371/journal.pone.0126681
- Olivar, M.P., Catalán, I.A., Emelianov, M., Fernández de Puellas, M.L., 2003. Early stages of *Sardina pilchardus* and environmental anomalies in the Northwestern Mediterranean. *Estuar. Coast. Shelf Sci.* 56, 609–619. doi:10.1016/S0272-7714(02)00210-X
- Palmieri, M.G., Barausse, A., Luisetti, T., Turner, K., 2014. Jellyfish blooms in the Northern Adriatic Sea: Fishermen's perceptions and economic impacts on fisheries. *Fish. Res.* 155, 51–58. doi:10.1016/j.fishres.2014.02.021
- Palmieri, M.G., Schaafsma, M., Luisetti, T., Barausse, A., Harwood, A., Sen, A., Turner, R.K., 2015. Jellyfish Blooms and Their Impacts on Welfare Benefits: Recreation in the UK and Fisheries in Italy, in: *Coastal Zones Ecosystem Services*. Springer International Publishing, pp. 219–240. doi:10.1007/978-3-319-17214-9
- Palomera, I., 1992. Spawning of anchovy *Engraulis encrasicolus* in the northwestern Mediterranean relative to hydrographic features in the region. *Mar. Ecol. Prog. Ser.* 79, 215–223. doi:10.3354/meps079215
- Palomera, I., Lleonart, J., 1989. Field mortality estimates of anchovy larvae, *Engraulis encrasicolus*, in the western Mediterranean. *J. Fish Biol.* 35, 133–138. doi:10.1111/j.1095-8649.1989.tb03054.x
- Palomera, I., Olivar, M.P., Salat, J., Sabatés, a., Coll, M., García, a., Morales-Nin, B., 2007. Small pelagic fish in the NW Mediterranean Sea: An ecological review. *Prog. Oceanogr.* 74, 377–396. doi:10.1016/j.pocean.2007.04.012
- Pauly, D., Graham, W., Libralato, S., Morissette, L., Palomares, M.L.D., 2009. Jellyfish in ecosystems, online databases, and ecosystem models. *Hydrobiologia* 616, 67–85. doi:10.1007/s10750-008-9583-x
- Perman, R., Ma, Y., Common, M., Maddison, D., Mcgilvray, J., 2011. *Natural Resource and Environmental Economics*, 4 edition. ed. Addison Wesley.
- Pertierra, J.P., Lleonart, J., Lo, N.C.H., 1997. Application of a stage-specific matrix model and length-cohort based analysis to assess the anchovy fishery in Catalan coastal (NW Mediterranean). *Fish. Res.* 30, 127–137.
- Purcell, J., Tilves, U., Fuentes, V., Milisenda, G., Olariaga, A., Sabatés, A., 2014. Digestion times and predation potentials of *Pelagia noctiluca* eating fish larvae and copepods in the NW Mediterranean Sea. *Mar. Ecol. Prog. Ser.* 510, 201–213. doi:10.3354/meps10790
- Purcell, J., Uye, S., Lo, W., 2007. Anthropogenic causes of jellyfish blooms and their direct consequences for humans: a review. *Mar. Ecol. Prog. Ser.* 350, 153–174. doi:10.3354/meps07093
- Purcell, J.E., Arai, M.N., 2001. Interactions of pelagic cnidarians and ctenophores with fish: a review. *Hydrobiologia* 451, 27–44.
- Purcell, J.E., Grover, J.J., 1990. Predation and food limitation as causes of mortality in larval herring at a spawning ground in. *Mar. Ecol. Prog. Ser.* 59, 55–61.

- Purcell, J.E., Nemazie, D.A., Dorsey, S.E., Houde, E.D., John Gamble, C., 1994. Predation mortality of bay anchovy *Anchoa mitchilli* eggs and larvae due to scyphomedusae and ctenophores in Chesapeake Bay. *Mar. Ecol. Prog. Ser.* 114, 47–58.
- Richardson, A.J., Bakun, A., Hays, G.C., Gibbons, M.J., 2009. The jellyfish joyride: causes, consequences and management responses to a more gelatinous future. *Trends Ecol. Evol.* 24, 312–22. doi:10.1016/j.tree.2009.01.010
- Romanelli, M., Colloca, F., Giovanardi, O., 2002. Growth and mortality of exploited *Sardina pilchardus* (Walbaum) larvae along the western coast of Italy. *Fish. Res.* 55, 205–218. doi:10.1016/S0165-7836(01)00286-7
- Rosa, S., Pansera, M., Granata, a., Guglielmo, L., 2013. Interannual variability, growth, reproduction and feeding of *Pelagia noctiluca* (Cnidaria: Scyphozoa) in the Straits of Messina (Central Mediterranean Sea): Linkages with temperature and diet. *J. Mar. Syst.* 111-112, 97–107. doi:10.1016/j.jmarsys.2012.10.001
- Rottini-Sandrini, L., Avian, M., 1991. Reproduction of *Pelagia noctiluca* in the central and northern Adriatic Sea. *Hydrobiologia* 66, 197–202.
- Sabatés, A., Pagès, F., Atienza, D., Fuentes, V., Purcell, J.E., Gili, J.-M., 2010. Planktonic cnidarian distribution and feeding of *Pelagia noctiluca* in the NW Mediterranean Sea. *Hydrobiologia* 645, 153–165. doi:10.1007/s10750-010-0221-z
- Sabatés, A., Salat, J., Palomera, I., Emelianov, M., De Puelles, M.L.F., Olivar, M.P., 2007. Advection of anchovy (*Engraulis encrasicolus*) larvae along the Catalan continental slope (NW Mediterranean). *Fish. Oceanogr.* 16, 130–141. doi:10.1111/j.1365-2419.2006.00416.x
- Sabatés, A., Salat, J., Raya, V., Emelianov, M., 2013. Role of mesoscale eddies in shaping the spatial distribution of the coexisting *Engraulis encrasicolus* and *Sardinella aurita* larvae in the northwestern Mediterranean. *J. Mar. Syst.* 111-112, 108–119. doi:10.1016/j.jmarsys.2012.10.002
- Sardá, R., Avila, C., Mora, J., 2005. A methodological approach to be used in integrated coastal zone management processes: the case of the Catalan Coast (Catalonia, Spain). *Estuar. Coast. Shelf Sci.* 62, 427–439. doi:10.1016/j.ecss.2004.09.028
- Tomlinson, B., Sastre, S., Blasco, D., Guillén, J., 2011. The Systems Approach Framework as a Complementary Methodology of Adaptive Management: a Case Study in the Urban Beaches of Barcelona. *Ecol. Soc.* 16, 28. doi:10.5751/ES-04484-160428
- Vandendriessche, S., Vansteenbrugge, L., Hostens, K., Maelfait, H., 2013. Jellyfish, jellypress and jellyperception. *Meded. ILVO*.



## 7 References

- Alemany, J. 1984. *Estat d'utilització de les platges del litoral català*. Departament de Política Territorial i Obres Públiques, Generalitat de Catalunya, Barcelona.
- Allen, C. R., and L. H. Gunderson. 2011. Pathology and failure in the design and implementation of adaptive management. *Journal of Environmental Management* 92(5):1379–1384.
- Anderson, J., and N. Carvalho. 2013. *Scientific, technical and economic committee for fisheries (STECF) – The 2013 annual economic report on the EU fishing fleet (STECF-13-15)*. Publications Office of the European Union, Luxembourg.
- Andonegi, E., J. A. Fernandes, I. Quincoces, X. Irigoien, A. Uriarte, A. Perez, D. Howell, and G. Stefansson. 2011. The potential use of a Gadget model to predict stock responses to climate change in combination with Bayesian networks: the case of Bay of Biscay anchovy. *ICES Journal of Marine Science* 68(6):1257–1269.
- Ariza, E., J. A. Jiménez, and R. Sardá. 2008. A critical assessment of beach management on the Catalan coast. *Ocean & Coastal Management* 51(2):141–160.
- Asselman, N. E. M. 1999. Suspended sediment dynamics in a large drainage basin: the River Rhine. *Hydrological Processes* 13(10):1437–1450.
- Avian, M., L. Rottini-Sandrini, A. Malej, and V. Axiak. 1983. The breeding period of *Pelagia noctiluca* (Scyphozoa, Semaestomeae) in the Adriatic and Central Mediterranean Sea. *Nova Thalassia* 6:65–75.
- Bailly, D., M. Estrada, T. S. Hopkins, A. Mette, M. Ribera D'Alcala, A. Sandberg, and P. Tett. 2011. *Sustaining coastal zone systems*. (P. Tett, A. Sandberg, and A. Mette, editors). Dunedin Academic Press Ltd, UK.
- Baranov, F. J. 1918. On the question of the biological basis of fisheries. *Nauchnye Issledovaniya Ikhriologicheskii Institutu Izvestiya* 1:81–128.
- Baretta, J. W., J. G. Baretta-Bekker, and P. Ruardij. 1996. From EMS to ERSEM, towards generic coastal ecosystem models. *Aquabiology* 18(3):197–209.
- Baretta-Bekker, J. G., and J. W. Baretta. 1997. Special issue: European regional seas ecosystem model II. *Journal of Sea Research* 38:169–436.
- Bas, C., E. Morales, and M. Rubió. 1955. *La pesca en España y Cataluña*. Instituto de Investigaciones Pesqueras, CSIC, Barcelona, Spain.
- Bax, N., A. Williamson, M. Agüero, E. Gonzalez, and W. Geeves. 2003. Marine invasive alien species: a threat to global biodiversity. *Marine Policy* 27(4):313–323.
- Begley, J., and D. Howell. 2004. *An overview of Gadget, the Globally applicable Area-Disaggregated General Ecosystem Toolbox*. ICES.

- Bell, F. W., and V. R. Leeworthy. 1990. Recreational demand by tourists for saltwater beach days. *Journal of Environmental Economics and Management* 18(3):189–205.
- van den Belt, M. 2004. *Mediated modeling: A system dynamics approach to environmental consensus building*. Island Press.
- von Bertalanffy, L. 1950. An outline of general system theory. *British Journal for the Philosophy of Science* 1:134–165.
- von Bertalanffy, L. 1968. *General system theory: Foundations, development, applications*. George Braziller Inc.
- Bertignac, M., P. Lehodey, and J. Hampton. 1998. A spatial population dynamics simulation model of tropical tunas using a habitat index based on environmental parameters. *Fisheries Oceanography* 7(3-4):326–334.
- Blakemore, F., and A. Williams. 2008. British tourists' valuation of a Turkish beach using contingent valuation and travel cost methods. *Journal of Coastal Research* 24(6):1469–1480.
- Bogstad, B., K. H. Hauge, and Ø. Ulltang. 1997. MULTSPEC - A multi-species model for fish and marine mammals in the Barents Sea. *North Atlantic Fisheries Science* 22:317–341.
- Bogstad, B., S. Tjelmeland, T. Tjelta, and Ø. Ulltang. 1992. *Description of a multi-species model for the Barents Sea (MULTSPEC) and a study of its sensitivity to assumptions on food preferences and stock sizes of harp seals and minke whales*. International whaling commission scientific committee report.
- Bolaños, R., G. Jorda, J. Cateura, J. Lopez, J. Puigdefabregas, J. Gomez, and M. Espino. 2009. The XIOM: 20 years of a regional coastal observatory in the Spanish Catalan coast. *Journal of Marine Systems* 77(3):237–260.
- Booty, W. G., I. Wong, D. Lam, and O. Resler. 2009. A decision support system for environmental effects monitoring. *Environmental Modelling & Software* 24(8):889–900.
- Borsuk, M. E., C. A. Stow, and K. H. Reckhow. 2004. A Bayesian network of eutrophication models for synthesis, prediction, and uncertainty analysis. *Ecological Modelling* 173(2-3):219–239.
- Butterworth, D. S., J. Harwood, and B. E. Programme. 1991. *Report on the Benguela ecology programme workshop on seal-fishery biological interactions*. Benguela Ecology Programme, Department Zoology, University of Cape Town.
- Cacchione, D. A., D. E. Drake, M. A. Losada, and R. Medina. 1990. Bottom-boundary-layer measurements on the continental shelf off the Ebro River, Spain. *Marine Geology* 95(3-4):179–192.
- Calvo, E., R. Simó, R. Coma, M. Ribes, J. Pascual, a Sabatés, J. Gili, and C. Pelejero. 2011. Effects of climate change on Mediterranean marine ecosystems: the case of the Catalan Sea. *Climate Research* 50(1):1–29.

- Canepa, A., V. Fuentes, A. Sabatés, S. Piraino, F. Boero, and J. M. Gili. 2014. *Pelagia noctiluca* in the Mediterranean Sea. Pages 237–266 in K. A. Pitt and C. H. Lucas, editors. *Jellyfish Blooms*. Springer Dordrecht Heidelberg London New York.
- Cardinale, M., A. Abella, J. Bellido, I. Biteto, F. Colloca, F. Fiorentino, M. Giannoulaki, B. Guijarro, A. Jadaud, L. Knittweis, J. Lloret, P. Martin, M. Murenu, B. Mustac, G. C. Osio, A. Quetglas, F. Quintanilla, M. Sbrana, G. Scarcella, F. Scott, M. T. Spedicato, V. Ticina, G. Tserpes, A. Tsikliras, H.-J. Rätz, and A. Cheilari. 2010. *Scientific, technical and economic committee for fisheries. Report of the SGMED-10-02 working group on the Mediterranean Part I*. Luxembourg: Publications Office of the European Union.
- Carson, R. 1962. *Silent spring*. Houghton Mifflin.
- Caswell, H. 2006. *Matrix population models: Construction, analysis and interpretation*. 2nd edition. Sinauer Associates Inc., U.S.
- Cembrano, G., J. Quevedo, M. Salamero, V. Puig, J. Figueras, and J. Mart. 2004. Optimal control of urban drainage systems . A case study. *Control Engineering Practice* 12:1–9.
- Chang, Y. C., F. W. Hong, and M. T. Lee. 2008. A system dynamic based DSS for sustainable coral reef management in Kenting coastal zone, Taiwan. *Ecological Modelling* 211(1-2):153–168.
- Chapin, F. S., G. P. Kofinas, and C. Folke, editors. 2009. *Principles of ecosystem stewardship: Resilience-based natural resource management in a changing world*. Springer, New York, New York, NY.
- Checkland, P. 1981. *Systems thinking, systems practice*. John Wiley & Sons, Ltd.
- Checkland, P., and J. Scholes. 1990. *Soft systems methodology in action*. John Wiley & Sons, Ltd.
- Christensen, V., and D. Pauly. 1992. ECOPATH II — a software for balancing steady-state ecosystem models and calculating network characteristics. *Ecological Modelling* 61(3-4):169–185.
- Christensen, V., and C. J. Walters. 2004. Ecopath with Ecosim: methods, capabilities and limitations. *Ecological Modelling* 172(2-4):109–139.
- CLABSA. (n.d.). Els dipòsits del PECLAB. <http://www.clabsa.es/CAT/DipositsBCN.asp>.
- Coll, M., I. Palomera, S. Tudela, and F. Sardà. 2006. Trophic flows, ecosystem structure and fishing impacts in the South Catalan Sea, Northwestern Mediterranean. *Journal of Marine Systems* 59(1-2):63–96.
- Condon, R. H., W. Graham, K. Pitt, and H. Cathy. 2012. Questioning the rise of gelatinous zooplankton in the world's oceans. *BioScience* 62(2):160–169.
- Conley, K. R., and K. R. Sutherland. 2015. Commercial fishers' perceptions of jellyfish interference in the Northern California Current. *ICES Journal of Marine Science*.
- Costanza, R. 1999. The ecological, economic, and social importance of the oceans. *Ecological Economics* 31(2):199–213.



- Costanza, R., and J. Farley. 2007. Ecological economics of coastal disasters: Introduction to the special issue. *Ecological Economics* 63(2-3):249–253.
- Costanza, R., R. De Groot, S. Farber, M. Grasso, B. Hannon, K. Limburg, S. Naeem, R. V. O. Neill, J. Paruelo, R. G. Raskin, and P. Sutton. 1998. The value of the world ' s ecosystem services and natural capital 1 387:8009.
- Crutzen, P. J. 2002. Geology of mankind. *Nature* 415(6867):23.
- Dai, J. J., S. Lorenzato, and D. . Rocke. 2004. A knowledge-based model of watershed assessment for sediment. *Environmental Modelling & Software* 19(4):423–433.
- Van Delden, H., P. Luja, and G. Engelen. 2007. Integration of multi-scale dynamic spatial models of socio-economic and physical processes for river basin management. *Environmental Modelling & Software* 22(2):223–238.
- Dinesen, G. E., K. Timmermann, E. Roth, S. Markager, L. Ravn-Jensen, M. Hjorth, M. Holmer, and J. G. Støttrup. 2011. Mussel production and water framework directive targets in the Limfjord, Denmark: An integrated assessment for use in system-based management. *Ecology and Society* 16(4):26.
- Dowlatabadi, H. 1995. Integrated assessment models of climate change. *Energy Policy* 23(4-5):289–296.
- Duarte, C. M., K. a. Pitt, C. H. Lucas, J. E. Purcell, S. I. Uye, K. Robinson, L. Brotz, M. B. Decker, K. R. Sutherland, A. Malej, L. Madin, H. Mianzan, J. M. Gili, V. Fuentes, D. Atienza, F. Pages, D. Breitbart, J. Malek, W. M. Graham, and R. H. Condon. 2013. Is global ocean sprawl a cause of jellyfish blooms? *Frontiers in Ecology and the Environment* 11(2):91–97.
- EC, IMF, OECD, UN, and World Bank. 2009. *The system of national accounts 2008*. European Communities, International Monetary Fund, Organisation for Economic Co-operation and Development, United Nations, World Bank, NY.
- Ehlers, E., and T. Krafft, editors. 2006. *Earth system science in the anthropocene*. Springer-Verlag. Berlin/Heidelberg.
- Eleria, A., and R. M. Vogel. 2005. Predicting fecal coliform bacteria levels in the Charles River, Massachusetts, USA. *Journal of the American Water Resources Association* 41(5):1195–1209.
- Erlich, P. R. 1968. *The population bomb*. A Sierra Club-Ballantine Book, New York.
- Ernstson, H., S. Sörlin, and T. Elmqvist. 2008. Social movements and ecosystem services — the role of social network structure in protecting and managing urban green areas in stockholm. *Ecology And Society* 13(2):39.
- Estrada, M. 1996. Primary production in the northwestern Mediterranean. *Scientia Marina* 60(Supl. 2):55–64.
- European Commission. 2010. *European system of accounts*. Publications Office of the European Union, Luxembourg.

- European Parliament and Council. 2002. Recommendation of the European Parliament and of the Council of 30 May 2002 concerning the implementation of integrated coastal zone management in Europe (2002/413/EC). *Official Journal of the European Communities* 24(7).
- EUROSTAT. 2014. *Eurostat regional yearbook 2014*. Publications Office of the European Union, Luxembourg.
- Fernández de Puellas, M. L., F. Alemany, and J. Jansá. 2007. Zooplankton time-series in the Balearic Sea (Western Mediterranean): Variability during the decade 1994–2003. *Progress in Oceanography* 74(2-3):329–354.
- Fernández, J. M., and M. A. E. Selma. 2004. The dynamics of water scarcity on irrigated landscapes: Mazarrón and Aguilas in south-eastern Spain. *System Dynamics Review* 20(2):117–137.
- Filatova, T., A. Voinov, and A. van der Veen. 2011. Land market mechanisms for preservation of space for coastal ecosystems: An agent-based analysis. *Environmental Modelling & Software* 26(2):179–190.
- Fischer, G., and L. Sun. 2001. Model based analysis of future land-use development in China. *Agriculture, Ecosystems & Environment* 85(1-3):163–176.
- Flo, E., E. Garcés, M. Manzanera, and J. Camp. 2011. Coastal inshore waters in the NW Mediterranean: Physicochemical and biological characterization and management implications. *Estuarine, Coastal and Shelf Science* 93(4):279–289.
- Folke, C. 2006. Resilience: The emergence of a perspective for social-ecological systems analyses. *Global Environmental Change* 16(3):253–267.
- Folke, C., S. Carpenter, T. Elmqvist, L. Gunderson, C. S. Holling, and B. Walker. 2002. Resilience and Sustainable Development: Building Adaptive Capacity in a World of Transformations. *AMBIO: A Journal of the Human Environment* 31(5):437–440.
- Folke, C., S. R. Carpenter, B. Walker, M. Scheffer, and T. Chapin. 2010. Resilience thinking: Integrating resilience, adaptability and transformability. *Ecology And Society* 15(4).
- Folke, C., S. Carpenter, B. Walker, M. Scheffer, T. Elmqvist, L. Gunderson, and C. S. Holling. 2004. Regime shifts, resilience, and biodiversity in ecosystem management. *Annual Review of Ecology, Evolution, and Systematics* 35:557–581.
- Font, A. R. 2000. Mass tourism and the demand for protected natural areas: A travel cost approach. *Journal of Environmental Economics and Management* 39(1):97–116.
- Font, J., J. Salat, and J. Tintore. 1988. Permanent features of the circulation in the Catalan Sea. *Oceanologica Acta, Special issue*.
- Forrester, J. 1968. *Principles of systems*. Cambridge, MA: MIT Press, US.
- Franzen, F., G. Kinell, J. Walve, R. Elmgren, and T. Soderqvist. 2011. Participatory social-ecological modeling in eutrophication management: The case of Himmerfjarden, Sweden. *Ecology And Society* 16(4).

- Froese, R., and D. Pauly. 2014. FishBase version (11/2014). <http://www.fishbase.org/>.
- Fugate, D., and B. Chant. 2006. Aggregate settling velocity of combined sewage overflow. *Marine pollution bulletin* 52(4):427–32.
- Fulton, E. A., A. D. . Smith, and C. R. Johnson. 2004a. Biogeochemical marine ecosystem models I: IGBEM—a model of marine bay ecosystems. *Ecological Modelling* 174(3):267–307.
- Fulton, E. A., A. D. . Smith, and C. R. Johnson. 2004b. Effects of spatial resolution on the performance and interpretation of marine ecosystem models. *Ecological Modelling* 176(1-2):27–42.
- Fulton, E. A., A. Smith, and A. Punt. 2005. Which ecological indicators can robustly detect effects of fishing? *ICES Journal of Marine Science* 62(3):540–551.
- Gao, L., and A. Hailu. 2012. Ranking management strategies with complex outcomes: An AHP-fuzzy evaluation of recreational fishing using an integrated agent-based model of a coral reef ecosystem. *Environmental Modelling & Software* 31:3–18.
- García, A., and I. Palomera. 1996. Anchovy early life history and its relation to its surrounding environment in the Western Mediterranean basin. *Scientia Marina* 60:155–166.
- Ghermandi, A., B. Galil, J. Gowdy, and P. a. L. D. Nunes. 2015. Jellyfish outbreak impacts on recreation in the Mediterranean Sea: welfare estimates from a socioeconomic pilot survey in Israel. *Ecosystem Services* 11:140–147.
- Gili, J. M., F. Pages, A. Sabatés, and J. D. Ros. 1988. Small-scale distribution of a cnidarian population in the western Mediterranean. *Journal of Plankton Research* 10(3):385–401.
- Gili, J. M., F. Pagès, and F. Vives. 1987. Distribution and ecology of a population of planktonic cnidarians in the western Mediterranean. Pages 157–170 in J. Bouillon, F. Boero, F. Cicogna, and P. F. S. Cornelius, editors. *Modern Trends in the Systematics, Ecology, and Evolution of Hydroids and Hydromedusae*. Oxford University Press.
- Goy, J., P. Morand, and M. Etienne. 1989. Long-term fluctuations of *Pelagia noctiluca* (Cnidaria, Scyphomedusa) in the western Mediterranean Sea. Prediction by climatic variables. *Deep Sea Research Part A. Oceanographic Research Papers* 36(2):269–279.
- Graham, W. M., D. L. Martin, D. L. Felder, V. L. Asper, and H. M. Perry. 2003. Ecological and economic implications of a tropical jellyfish invader in the Gulf of Mexico. *Biological Invasions* 5(1-2):53–69.
- Guillén, J., A. García-Olivares, E. Ojeda, A. Osorio, O. Chic, and R. González. 2008. Long-term quantification of beach users using video monitoring. *Journal of Coastal Research* 246(246):1612–1619.
- Guimarães, M. H. E., A. Mascarenhas, C. Sousa, T. Boski, and T. P. Dentinho. 2012. The impact of water quality changes on the socio-economic system of the Guadiana Estuary: an assessment of management options. *Ecology and Society* 17(3):38.
- Gurevitch, J., and D. K. Padilla. 2004. Are invasive species a major cause of extinctions? *Trends in ecology & evolution* 19(9):470–4.

- Håkanson, L., A. Gyllenhammar, and A. Brolin. 2004. A dynamic compartment model to predict sedimentation and suspended particulate matter in coastal areas. *Ecological Modelling* 175(4):353–384.
- Hamilton, S. H., S. ElSawah, J. H. a. Guillaume, A. J. Jakeman, and S. a. Pierce. 2015. Integrated assessment and modelling: Overview and synthesis of salient dimensions. *Environmental Modelling & Software* 64:215–229.
- Hare, M., and C. Pahl-Wostl. 2002. Stakeholder Categorisation in Participatory Integrated Assessment Processes. *Integrated Assessment* 3(1):50–62.
- Helgason, T., H. Gislason, and D. Havundersøgelse. 1979. *VPA-analysis with special interaction due to predation*. Danmarks Fiskeri-og Havundersøgelse.
- Hjort, J. 1914. Fluctuations in the great fisheries of northern Europe, viewed in the light of biological research. *Conseil International pour l'Exploration de la Mer: Rapports et Proces-Verbaux* 20:1–228.
- Holling, C. S. 1978. *Adaptive environmental assessment and management*. John Wiley, New York, New York, USA.
- Holling, C. S. 2001. Understanding the complexity of economic, ecological, and social systems. *Ecosystems* 4(5):390–405.
- Holling, C. S., and L. H. Gunderson. 2001. Resilience and adaptive cycles. Pages 25–62 in L. H. Gunderson and C. S. Holling, editors. *Panarchy: understanding transformations in human and natural systems*. Island Press, Washington D.C., USA.
- Holling, C. S., and G. K. Meffe. 1996. Command and control and the pathology of natural resource management. *Conservation Biology* 10(2):328–337.
- Hopkins, T. S., and D. Bailly. 2013. *The role of science in the transition to sustainability: the Systems Approach Framework for Integrated Coastal Zone Management*. (E. Moksness, E. Dahl, and J. Støttrup, editors). John Wiley & Sons, Ltd, Oxford, UK.
- Hopkins, T. S., D. Bailly, R. Elmgren, G. Glegg, A. Sandberg, and J. G. Støttrup. 2012. A systems approach framework for the transition to sustainable development: Potential value based on coastal experiments. *Ecology and Society* 17(3):39.
- Hopkins, T. S., D. Bailly, and J. G. Støttrup. 2011. A systems approach framework for coastal zones. *Ecology and Society* 16(4):25.
- Huertas, E., M. Folch, M. Salgot, I. Gonzalvo, and C. Passarell. 2006. Constructed wetlands effluent for streamflow augmentation in the Besòs River (Spain). *Desalination* 188(1-3):141–147.
- IDESCAT. 2005. Input-Output Framework for Catalonia. <http://www.idescat.cat/en/economia/mioc/>.
- IDESCAT. 2010. *Anuari estadístic de Catalunya. 2010*. Institut d'Estadística de Catalunya.
- Jakeman, A. J., and R. Letcher. 2003. Integrated assessment and modelling: features, principles and examples for catchment management. *Environmental Modelling & Software* 18(6):491–501.

- Jakeman, A. J., R. A. Letcher, and J. P. Norton. 2006. Ten iterative steps in development and evaluation of environmental models. *Environmental Modelling & Software* 21(5):602–614.
- Kaplan, I. C., P. J. Horne, and P. S. Levin. 2012. Screening California Current fishery management scenarios using the Atlantis end-to-end ecosystem model. *Progress in Oceanography* 102:5–18.
- Kay, R., and J. Alder. 2007. *Coastal planning and management*. Second Edi. CRC Press.
- Kelly, R. A., A. J. Jakeman, O. Barreteau, M. E. Borsuk, S. ElSawah, S. H. Hamilton, H. J. Henriksen, S. Kuikka, H. R. Maier, A. E. Rizzoli, H. van Delden, and A. Voinov. 2013. Selecting among five common modelling approaches for integrated environmental assessment and management. *Environmental Modelling & Software* 47:159–181.
- van Kerkhoff, L. 2005. Integrated research: concepts of connection in environmental science and policy. *Environmental Science & Policy* 8(5):452–463.
- King, G. 2003. The role of participation in the European demonstration projects in ICZM. *Coastal Management* 31(2):137–143.
- Kontogianni, A. D., and C. J. Emmanouilides. 2014. The cost of a gelatinous future and loss of critical habitats in the Mediterranean. *ICES Journal of Marine Science* 71(4):853–866.
- Kuikka, S., M. Hildén, H. Gislason, S. Hansson, H. Sparholt, and O. Varis. 1999. Modeling environmentally driven uncertainties in Baltic cod (*Gadus morhua*) management by Bayesian influence diagrams. *Canadian Journal of Fisheries and Aquatic Sciences* 56(4):629–641.
- Kuper, M., C. Mullon, Y. Poncet, and E. Benga. 2003. Integrated modelling of the ecosystem of the Niger river inland delta in Mali. *Ecological Modelling* 164(1):83–102.
- Lam, D., L. Leon, S. Hamilton, N. Crookshank, D. Bonin, and D. Swayne. 2004. Multi-model integration in a decision support system: a technical user interface approach for watershed and lake management scenarios. *Environmental Modelling & Software* 19(3):317–324.
- Lauf, S., D. Haase, P. Hostert, T. Lakes, and B. Kleinschmit. 2012. Uncovering land-use dynamics driven by human decision-making – A combined model approach using cellular automata and system dynamics. *Environmental Modelling & Software* 27-28:71–82.
- Le, Q. B., R. Seidl, and R. W. Scholz. 2012. Feedback loops and types of adaptation in the modelling of land-use decisions in an agent-based simulation. *Environmental Modelling & Software* 27-28:83–96.
- Lefkovich, L. P. 1965. The study of population growth in organisms grouped by stages. *Biometrics* 21(1):1–18.
- Lehodey, P. 2001. The pelagic ecosystem of the tropical Pacific Ocean: dynamic spatial modelling and biological consequences of ENSO. *Progress in Oceanography* 49(1-4):439–468.
- Lehodey, P., J.-M. André, M. Bertignac, J. Hampton, A. Stoens, C. E. Menkès, and L. Mémary. 1998. Predicting skipjack tuna forage distributions in the equatorial Pacific using a coupled dynamical bio-geochemical model. *Fisheries Oceanography* 7(3-4):317–325.

- Lehodey, P., F. Chai, and J. Hampton. 2003. Modelling climate-related variability of tuna populations from a coupled ocean-biogeochemical-populations dynamics model. *Fisheries Oceanography* 12(4-5):483–494.
- Leontief, W. 1986. *Input-Output Economics*. 2nd edition. Oxford University Press.
- Leslie, P. H. 1945. On the use of matrices in certain population mathematics. *Biometrika* 33(3):183–212.
- Letcher, R. A., B. F. W. Croke, W. S. Merritt, and A. J. Jakeman. 2006. An integrated modelling toolbox for water resources assessment and management in highland catchments: Sensitivity analysis and testing. *Agricultural Systems* 89(1):132–164.
- Levontin, P., S. Kulmala, P. Haapasaari, and S. Kuikka. 2011. Integration of biological, economic, and sociological knowledge by Bayesian belief networks: The interdisciplinary evaluation of potential management plans for Baltic salmon. *ICES Journal of Marine Science* 68(3):632–638.
- Liquete, C., M. Canals, W. Ludwig, and P. Arnau. 2009. Sediment discharge of the rivers of Catalonia, NE Spain, and the influence of human impacts. *Journal of Hydrology* 366(1-4):76–88.
- Liu, Y., H. Gupta, E. Springer, and T. Wagener. 2008. Linking science with environmental decision making: Experiences from an integrated modeling approach to supporting sustainable water resources management. *Environmental Modelling & Software* 23(7):846–858.
- Lleonart, J., R. Franquesa, and F. Maynou. 1998. MEFISTO: Bio-Economic Model for Mediterranean Fisheries. <http://www.mefisto.info/>.
- Lleonart, J., and F. Maynou. 2003. Fish stock assessments in the Mediterranean: state of the art. *Scientia Marina* 67:37–49.
- Lleonart, J., F. Maynou, L. Recasens, and R. Franquesa. 2003. A bioeconomic model for Mediterranean fisheries, the hake off Catalonia (western Mediterranean) as a case study. *Scientia Marina* 67:337–351.
- López, A. M. 1995. La plataforma continental del litoral Español. *Ingeniería del agua* 2(1).
- Luccini, E., A. Cede, and R. D. Piacentini. 2003. Effect of clouds on UV and total irradiance at Paradise Bay , Antarctic Peninsula , from a summer 2000 campaign. *Theoretical and Applied Climatology* 75:105–116.
- Ludwig, W., E. Dumont, M. Meybeck, and S. Heussner. 2009. River discharges of water and nutrients to the Mediterranean and Black Sea: Major drivers for ecosystem changes during past and future decades? *Progress in Oceanography* 80(3-4):199–217.
- Magnússon, K. G. 1995. An overview of the multispecies VPA - theory and applications. *Reviews in Fish Biology and Fisheries* 5(2):195–212.
- Malej, A. 1989. Behaviour and trophic ecology of the jellyfish *Pelagia noctiluca* (Forsskhil, 1775). *Journal of Experimental Marine Biology and Ecology* 126(3):259–270.

- Malej, A., and M. Malej. 1992. Population dynamics of the jellyfish pelagia noctiluca. Pages 215–219 in G. Colombo and I. Ferrara, editors. *Marine Eutrophication and Population Dynamics*. Olsen & Olsen, Freensborg.
- Mantzouni, I., S. Somarakis, D. K. Moutopoulos, A. Kallianiotis, and C. Koutsikopoulos. 2007. Periodic, spatially structured matrix model for the study of anchovy (*Engraulis encrasicolus*) population dynamics in N Aegean Sea (E. Mediterranean). *Ecological Modelling* 208(2-4):367–377.
- Marsili-Libelli, S. 2004. Fuzzy prediction of the algal blooms in the Orbetello lagoon. *Environmental Modelling & Software* 19(9):799–808.
- Martín de Santa Olalla, F., A. Dominguez, F. Ortega, A. Artigao, and C. Fabeiro. 2007. Bayesian networks in planning a large aquifer in Eastern Mancha, Spain. *Environmental Modelling & Software* 22(8):1089–1100.
- Martín, P., N. Bahamon, A. Sabatés, F. Maynou, P. Sánchez, and M. Demestre. 2008. European anchovy (*Engraulis encrasicolus*) landings and environmental conditions on the Catalan Coast (NW Mediterranean) during 2000–2005. *Hydrobiologia* 612(1):185–199.
- Martínez, M. L., A. Intralawan, G. Vázquez, O. Pérez-Maqueo, P. Sutton, and R. Landgrave. 2007. The coasts of our world: Ecological, economic and social importance. *Ecological Economics* 63(2-3):254–272.
- Martín-López, B., E. Gómez-Baggethun, P. L. Lomas, and C. Montes. 2009. Effects of spatial and temporal scales on cultural services valuation. *Journal of Environmental Management* 90(2):1050–1059.
- Mathevet, R., F. Bousquet, C. Le Page, and M. Antona. 2003. Agent-based simulations of interactions between duck population, farming decisions and leasing of hunting rights in the Camargue (Southern France). *Ecological Modelling* 165(2-3):107–126.
- Matthies, M., J. Berlekamp, S. Lautenbach, N. Graf, and S. Reimer. 2006. System analysis of water quality management for the Elbe river basin. *Environmental Modelling & Software* 21(9):1309–1318.
- Maynou, F. 2014. Coviability analysis of Western Mediterranean fisheries under MSY scenarios for 2020. *ICES Journal of Marine Science* 71(7):1563–1571.
- Maynou, F., F. Sardà, S. Tudela, and M. Demestre. 2006. Management strategies for red shrimp (*Aristeus antennatus*) fisheries in the Catalan sea (NW Mediterranean) based on bioeconomic simulation analysis. *Aquatic Living Resources* 19(2):161–171.
- McKenna, J., and A. Cooper. 2006. Sacred cows in coastal management: the need for a “cheap and transitory” model. *Area* 38(4):421–431.
- Meadows, D. H., D. L. Meadows, J. Randers, and W. W. Behrens III. 1972. *The limits to growth*. Universe Books.
- Melaku Canu, D., P. Campostrini, S. Dalla Riva, R. Pastres, L. Pizzo, L. Rossetto, and C. Solidoro. 2011. Addressing sustainability of clam farming in the Venice lagoon. *Ecology and Society* 16(3):20.

- Metcalf & Eddy. 1991. *Wastewater engineering: Treatment, disposal and reuse (Metcalf & Eddy)*. (G. Tchobanoglous and F. Burton, editors). 2nd edition. McGraw-Hill Education.
- Millennium Ecosystem Assessment. 2005a. *Ecosystems and human well-being: Synthesis report*. Island Press, Washington.
- Millennium Ecosystem Assessment. 2005b. *Ecosystems and human well-being: Current state and trends*. Island Press, Washington.
- Mitchell, B. 1990. *Integrated Water Management: International Experiences and Perspectives*. Belhaven Press, London, UK.
- Moksness, E., J. Gjøvsæter, G. Lagailarde, E. Mikkelsen, E. M. Olsen, H. T. Sandersen, and J. H. Vølstad. 2011. Effects of fishing tourism in a coastal municipality: a case study from Risør, Norway. *Ecology and Society* 16(3):11.
- Molina, J. L., J. Bromley, J. L. García-Aróstegui, C. Sullivan, and J. Benavente. 2010. Integrated water resources management of overexploited hydrogeological systems using Object-Oriented Bayesian Networks. *Environmental Modelling & Software* 25(4):383–397.
- Molnar, J. L., R. L. Gamboa, C. Revenga, and M. D. Spalding. 2008. Assessing the global threat of invasive species to marine biodiversity. *Frontiers in Ecology and the Environment* 6(9):485–492.
- Moncheva, S., E. Racheva, L. Kamburska, and J. D’Heroncourt. 2012. Environmental and management constraints on tourism in Varna bay, Bulgarian black sea coast. *Ecology and Society* 17(3):35.
- Mongruel, R., J. Prou, J. Ballé-Béganton, M. Lample, A. Vanhoutte-Brunier, H. Réthoret, J. A. P. Agúndez, F. Vernier, P. Bordenave, and C. Bacher. 2011. Modeling soft institutional change and the improvement of freshwater governance in the coastal zone. *Ecology and Society* 16(4):15.
- Münier, B., K. Birr-Pedersen, and J. . Schou. 2004. Combined ecological and economic modelling in agricultural land use scenarios. *Ecological Modelling* 174(1-2):5–18.
- Muñoz, J., and P. Rubio. 1995. Predicción estival del riesgo de blooms de *Pelagia Nostiluca* (Litoral Central Catalán). Pages 281–288 *Situaciones de riesgo climático en España: trabajos presentados a la II Reunión del Grupo de Climatología de la Asociación de Geógrafos Españoles, celebrada en Jaca (Huesca), 15 a 17 de septiembre de 1995*. Instituto Pirenaico de Ecología, Spain.
- Myers, R. A. 2002. Recruitment: Understanding density-dependence in fish populations. in P. J. B. Hart and J. D. Reynolds, editors. *Handbook of fish biology and fisheries, Volume 1: Fish biology*. Blackwell Publishing Ltd, Oxford, UK, Oxford, UK.
- Nastav, B., M. Malej, and A. Malej. 2013. Is it possible to determine the economic impact of jellyfish outbreaks on fisheries? A case study - Slovenia. *Mediterranean Marine Science* 14(1):214–223.
- National Restaurant Association, and Deloitte. 2010. Restaurant industry operations report 2010 edition. National Restaurant Association, Research and knowledge center, 1200 Seventeenth Street, NW Washington, DC 20036-3097.



- Newham, L. T. H., A. J. Jakeman, and R. A. Letcher. 2007. Stakeholder participation in modelling for integrated catchment assessment and management: An Australian case study. *International Journal of River Basin Management* 5(2):79–91.
- Nicholls, R. J., and F. M. J. Hoozemans. 1996. The Mediterranean: vulnerability to coastal implications of climate change. *Ocean & Coastal Management* 31(2-3):105–132.
- Nicholls, R. J., P. P. Wong, V. Burkett, J. Codignotto, J. Hay, R. McLean, S. Ragoonaden, and C. D. Woodroffe. 2007. *Coastal systems and low-lying areas. Climate Change 2007: Impacts, Adaptation and Vulnerability. Contribution of Working Group II to the Fourth Assessment Report of the Intergovernmental Panel on Climate Change.* (P. J. van der L. and C. E. H. M.L. Parry, O.F. Canziani, J.P. Palutikof, editor). Cambridge University Press, Cambridge, UK.
- Novoa, M., and J. Alemany. 2005. *Evolución de la costa de Barcelona.* Dirección General de Costas. Ministerio de Medio Ambiente, Madrid, Spain.
- Nunes, P. A. L. D., M. Loureiro, L. Piñol, and S. Sastre. 2015. Analyzing beach recreationists' preferences for the reduction of jellyfish blooms: Economic results from a stated-choice experiment in Catalonia, Spain. *PLoS ONE* 10(6):1–34.
- Odum, H. T. 1971. *Environment, power and society.* Wiley-Blackwell.
- Odum, H. T. 2002. Explanations of ecological relationships with energy systems concepts. *Ecological Modelling* 158(3):201–211.
- Odum, H. T., and N. Peterson. 1996. Simulation and evaluation with energy systems blocks. *Ecological Modelling* 93(1-3):155–173.
- OECD. 2001. *The Well-being of nations: The role of human and social capital.* OECD Publishing, Paris, France.
- Olivar, M. P., I. A. Catalán, M. Emelianov, and M. L. Fernández de Puellas. 2003. Early stages of *Sardina pilchardus* and environmental anomalies in the Northwestern Mediterranean. *Estuarine, Coastal and Shelf Science* 56(3-4):609–619.
- Olivar, M., J. Salat, and I. Palomera. 2001. Comparative study of spatial distribution patterns of the early stages of anchovy and pilchard in the NW Mediterranean Sea. *Marine Ecology Progress Series* 217:111–120.
- Ostrom, E., and T. K. Ahn. 2010. *Foundations of social capital, Critical studies in economic institutions* 2. Reprint. Edward Elgar Publishing Ltd.
- Palomera, I. 1992. Spawning of anchovy *Engraulis encrasicolus* in the northwestern Mediterranean relative to hydrographic features in the region. *Marine Ecology Progress Series* 79:215–223.
- Palomera, I., M. P. Olivar, J. Salat, a. Sabatés, M. Coll, a. García, and B. Morales-Nin. 2007. Small pelagic fish in the NW Mediterranean Sea: An ecological review. *Progress in Oceanography* 74(2-3):377–396.

- Parker, P., R. Letcher, a Jakeman, M. . Beck, G. Harris, R. . Argent, M. Hare, C. Pahl-Wostl, a Voinov, M. Janssen, P. Sullivan, M. Scoccimarro, a Friend, M. Sonnenshein, D. Barker, L. Matejicek, D. Odulaja, P. Deadman, K. Lim, G. Larocque, P. Tarikhi, C. Fletcher, a Put, T. Maxwell, a Charles, H. Breeze, N. Nakatani, S. Mudgal, W. Naito, O. Osidele, I. Eriksson, U. Kautsky, E. Kautsky, B. Naeslund, L. Kumblad, R. Park, S. Maltagliati, P. Girardin, a Rizzoli, D. Mauriello, R. Hoch, D. Pelletier, J. Reilly, R. Olafsdottir, and S. Bin. 2002. Progress in integrated assessment and modelling. *Environmental Modelling & Software* 17(3):209–217.
- Parrott, L., C. Chion, C. C. A. Martins, P. Lamontagne, S. Turgeon, J. A. Landry, B. Zhens, D. J. Marceau, R. Michaud, G. Cantin, N. Ménard, and S. Dionne. 2011. A decision support system to assist the sustainable management of navigation activities in the St. Lawrence River Estuary, Canada. *Environmental Modelling & Software* 26(12):1403–1418.
- Parsons, G. R. 2003. *A primer on nonmarket valuation: The travel cost model*. (P. A. Champ, K. J. Boyle, and T. C. Brown, editors). Springer Netherlands.
- Pauly, D., W. Graham, S. Libralato, L. Morissette, and M. L. D. Palomares. 2009. Jellyfish in ecosystems, online databases, and ecosystem models. *Hydrobiologia* 616:67–85.
- Pertierra, J. P., J. Leonart, and N. C. H. Lo. 1997. Application of a stage-specific matrix model and length-cohort based analysis to assess the anchovy fishery in Catalan coastal (NW Mediterranean). *Fisheries Research* 30(1-2):127–137.
- Petersen, C. G. J. 1896. The yearly immigration of young plaice into the Limfjord from the German Sea. *Reports of the Danish Biological Station* 6:1–48.
- Piccinetti, C., and G. Piccinetti-Manfrin. 1991. Observations ulterieures sur la dynamique de *Pelagia noctiluca*. *UNEP workshop, Jellyfish blooms in the Mediterranean Sea, Proceedings of II Workshop on Jellyfish in the Mediterranean Sea. Athens*.
- Plagányi, É. E. 2007. Models for an ecosystem approach to fisheries. Page 108 *FAO Fisheries Technical Paper. No. 477*. Rome, FAO.
- Pollino, C. A., O. Woodberry, A. Nicholson, K. Korb, and B. T. Hart. 2007. Parameterisation and evaluation of a Bayesian network for use in an ecological risk assessment. *Environmental Modelling & Software* 22(8):1140–1152.
- Polovina, J. J. 1984. Model of a coral reef ecosystem. *Coral Reefs* 3(1):1–11.
- Pope, J. G. 1991. The ICES Multispecies Assessment Working Group: evolution, insights, and future problems. Pages 22–23 *ICES Marine Science Symposium*.
- Prell, C., K. Hubacek, and M. Reed. 2009. Stakeholder analysis and social network analysis in natural resource management. *Society & Natural Resources* 22(6):501–518.
- Purcell, J. E., and M. N. Arai. 2001. Interactions of pelagic cnidarians and ctenophores with fish: a review. *Hydrobiologia* 451(1-3):27–44.
- Purcell, J. E., and J. J. Grover. 1990. Predation and food limitation as causes of mortality in larval herring at a spawning ground in. *Marine Ecology Progress Series* 59:55–61.

- Purcell, J. E., D. A. Nemazie, S. E. Dorsey, E. D. Houde, and C. John Gamble. 1994. Predation mortality of bay anchovy *Anchoa mitchilli* eggs and larvae due to scyphomedusae and ctenophores in Chesapeake Bay. *Marine Ecology Progress Series* 114:47–58.
- Purcell, J., U. Tilves, V. Fuentes, G. Milisenda, A. Olariaga, and A. Sabatés. 2014. Digestion times and predation potentials of *Pelagia noctiluca* eating fish larvae and copepods in the NW Mediterranean Sea. *Marine Ecology Progress Series* 510:201–213.
- Purcell, J., S. Uye, and W. Lo. 2007. Anthropogenic causes of jellyfish blooms and their direct consequences for humans: a review. *Marine Ecology Progress Series* 350:153–174.
- Qin, H.-P., Q. Su, and S.-T. Khu. 2011. An integrated model for water management in a rapidly urbanizing catchment. *Environmental Modelling & Software* 26(12):1502–1514.
- Quesnay, F. 1758. *Tableau Economique*.
- Ramage, M., and K. Shipp. 2009. *Systems thinkers*. Springer London.
- Reed, M. S., A. Graves, N. Dandy, H. Posthumus, K. Hubacek, J. Morris, C. Prell, C. H. Quinn, and L. C. Stringer. 2009. Who's in and why? A typology of stakeholder analysis methods for natural resource management. *Journal of environmental management* 90(5):1933–49.
- Richardson, A. J., A. Bakun, G. C. Hays, and M. J. Gibbons. 2009. The jellyfish joyride: causes, consequences and management responses to a more gelatinous future. *Trends in ecology & evolution* 24(6):312–22.
- Risbey, J., M. Kandlikar, and A. Patwardhan. 1996. Assessing integrated assessments. *Climatic Change* 34(3-4):369–395.
- Rivington, M., K. B. Matthews, G. Bellocchi, K. Buchan, C. O. Stöckle, and M. Donatelli. 2007. An integrated assessment approach to conduct analyses of climate change impacts on whole-farm systems. *Environmental Modelling & Software* 22(2):202–210.
- Roig, E. 1927. *La pesca a Catalunya*. Noray, Barcelona, Spain.
- Romanelli, M., F. Colloca, and O. Giovanardi. 2002. Growth and mortality of exploited *Sardina pilchardus* (Walbaum) larvae along the western coast of Italy. *Fisheries Research* 55(1-3):205–218.
- Rosa, S., M. Pansera, a. Granata, and L. Guglielmo. 2013. Interannual variability, growth, reproduction and feeding of *Pelagia noctiluca* (Cnidaria: Scyphozoa) in the Straits of Messina (Central Mediterranean Sea): Linkages with temperature and diet. *Journal of Marine Systems* 111-112:97–107.
- Rossi, L., V. Krejci, W. Rauch, S. Kreikenbaum, R. Fankhauser, and W. Gujer. 2005. Stochastic modeling of total suspended solids (TSS) in urban areas during rain events. *Water research* 39(17):4188–96.
- Rotmans, J. 1998. Methods for IA: The challenges and opportunities ahead. *Environmental Modeling & Assessment* 3(3):155–179.

- Rotmans, J., and M. van Asselt. 1996. Integrated assessment: A growing child on its way to maturity. *Climatic Change* 34(3-4):327–336.
- Rottini-Sandrini, L., and M. Avian. 1991. Reproduction of *Pelagia noctiluca* in the central and northern Adriatic Sea. *Hydrobiologia* 66:197–202.
- Sabatés, A. 1990. Distribution pattern of larval fish populations in the Northwestern Mediterranean. *Marine Ecology Progress Series* 59:75–82.
- Sabatés, A., F. Pagès, D. Atienza, V. Fuentes, J. E. Purcell, and J.-M. Gili. 2010. Planktonic cnidarian distribution and feeding of *Pelagia noctiluca* in the NW Mediterranean Sea. *Hydrobiologia* 645(1):153–165.
- Sabatés, A., J. Salat, I. Palomera, M. Emelianov, M. L. F. De Puelles, and M. P. Olivar. 2007. Advection of anchovy (*Engraulis encrasicolus*) larvae along the Catalan continental slope (NW Mediterranean). *Fisheries Oceanography* 16(2):130–141.
- Sabatés, A., J. Salat, V. Raya, and M. Emelianov. 2013. Role of mesoscale eddies in shaping the spatial distribution of the coexisting *Engraulis encrasicolus* and *Sardinella aurita* larvae in the northwestern Mediterranean. *Journal of Marine Systems* 111-112:108–119.
- Sabatés, A., N. Zaragoza, C. Grau, and J. Salat. 2008. Vertical distribution of early developmental stages in two coexisting clupeoid species, *Sardinella aurita* and *Engraulis encrasicolus*. *Marine Ecology Progress Series* 364:169–180.
- Salat, J., and J. Font. 1987. Water mass structure near and offshore the Catalan Sea during winters of 1982 and 1983. *Annales Geophysicae* 5B(1):49–54.
- Sardá, R., C. Avila, and J. Mora. 2005. A methodological approach to be used in integrated coastal zone management processes: the case of the Catalan Coast (Catalonia, Spain). *Estuarine, Coastal and Shelf Science* 62(3):427–439.
- Sardá, R., J. Mora, E. Ariza, C. Avila, and J. A. Jimenez. 2009. Decadal shifts in beach user sand availability on the Costa Brava (Northwestern Mediterranean Coast). *Tourism Management* 30(2):158–168.
- Schlüter, M., and N. Rüger. 2007. Application of a GIS-based simulation tool to illustrate implications of uncertainties for water management in the Amudarya river delta. *Environmental Modelling & Software* 22(2):158–166.
- Schreinemachers, P., and T. Berger. 2011. An agent-based simulation model of human–environment interactions in agricultural systems. *Environmental Modelling & Software* 26(7):845–859.
- Shin, Y. 2001. Exploring fish community dynamics through size-dependent trophic interactions using a spatialized individual-based model. *Aquatic Living Resources* 14(2):65–80.
- Shin, Y.-J., and P. Cury. 2004. Using an individual-based model of fish assemblages to study the response of size spectra to changes in fishing. *Canadian Journal of Fisheries and Aquatic Sciences* 61(3):414–431.

- Small, C., and R. J. Nicholls. 2003. A Global Analysis of Human Settlement in Coastal Zones. *Journal of Coastal Research* 19(3):pp. 584–599.
- Smith, T. D. 2002. A history of fisheries and their science and management. in P. J. B. Hart and J. D. Reynolds, editors. *Handbook of fish biology and fisheries, Volume 2: Fisheries*. Blackwell Publishing Ltd, Oxford, UK, Oxford, UK.
- Soonthornnonda, P., and E. R. Christensen. 2008. Source apportionment of pollutants and flows of combined sewer wastewater. *Water research* 42(8-9):1989–98.
- Sorensen, J. 2002. *Baseline 2000 background report: The status of integrated coastal management as an international practice (Second iteration)*. Urban Harbors Institute Publications.
- Soulsby, R. 1997. *Dynamics of Marine Sands*. Thomas Telford Publications, Thomas Telford Services Ltd, 1 Heron Quay, London E14 4JD.
- SPICOSA. 2011. <http://www.spicosa.eu/>.
- Stefansson, G., and O. K. Pálsson. 1998. Points of view: A framework for multispecies modelling of Arcto-boreal systems. *Reviews in Fish Biology and Fisheries* 8(1):101–104.
- Stefánsson, G., and Ó. K. Pálsson. 1997. Bormicon: a boreal migration and consumption model. Marine Research Institute. Reykjavik, Iceland.
- Stokes, T. K. 1992. An overview of the North Sea multispecies modelling work in ICES. *South African Journal of Marine Science* 12(1):1051–1060.
- Strasser, U., U. Vilsmaier, F. Prettenhaler, T. Marke, R. Steiger, A. Damm, F. Hanzer, R. A. I. Wilcke, and J. Stötter. 2014. Coupled component modelling for inter- and transdisciplinary climate change impact research: Dimensions of integration and examples of interface design. *Environmental Modelling & Software* 60:180–187.
- Suárez, J., and J. Puertas. 2005. Determination of COD, BOD, and suspended solids loads during combined sewer overflow (CSO) events in some combined catchments in Spain. *Ecological Engineering* 24(3):199–217.
- Ticehurst, J. L., L. T. H. Newham, D. Rissik, R. A. Letcher, and A. J. Jakeman. 2007. A Bayesian network approach for assessing the sustainability of coastal lakes in New South Wales, Australia. *Environmental Modelling & Software* 22(8):1129–1139.
- Tjelmeland, S., and B. Bogstad. 1998. MULTSPEC – a review of a multispecies modelling project for the Barents Sea. *Fisheries Research* 37(1-3):127–142.
- Tolun, L. G., S. Ergenekon, S. M. Hocaoglu, A. S. Donertas, T. Cokacar, S. Husrevoglu, C. P. Beken, and A. Baban. 2012. Socioeconomic response to water quality: a first experience in science and policy integration for the Izmit Bay coastal system. *Ecology and Society* 17(3):40.
- Tomlinson, B., S. Sastre, D. Blasco, and J. Guillén. 2011. The Systems Approach Framework as a complementary methodology of Adaptive Management: a case study in the urban beaches of Barcelona. *Ecology and Society* 16(4):28.

- Trenkel, V. M., J. K. Pinnegar, J. L. Blanchard, and A. N. Tidd. 2004. Can multispecies models be expected to provide better assessments for Celtic sea groundfish stocks? *ICES Annual Science Conference*. ICES, Copenhagen, Denmark.
- Trites, A. W., P. A. Livingston, S. Mackinson, M. C. Vasconcellos, A. M. Springer, and D. Pauly. 1999. Ecosystem change and the decline of marine mammals in the Eastern Bering Sea: Testing the ecosystem shift and commercial whaling hypotheses. *Fisheries Centre Research Reports* 7(1):106.
- Valdemoro, H. I., and J. a. Jiménez. 2006. The influence of shoreline dynamics on the use and exploitation of Mediterranean tourist beaches. *Coastal Management* 34(4):405–423.
- Vellido, A., E. Martí, J. Comas, I. Rodríguez-Roda, and F. Sabater. 2007. Exploring the ecological status of human altered streams through Generative Topographic Mapping. *Environmental Modelling & Software* 22(7):1053–1065.
- Vennix, J. 1996. *Group Model Building: Facilitating Team Learning Using System Dynamics*. John Wiley & Sons, Ltd.
- Villarrubia, M., a. Coronas, and M. Llorens. 1980. Solar radiation incident on tilted flat surfaces in Barcelona, Spain. *Solar Energy* 25(3):259–263.
- Voinov, A., R. Costanza, L. Wainger, R. Boumans, F. Villa, T. Maxwell, and H. Voinov. 1999. Patuxent landscape model: integrated ecological economic modeling of a watershed. *Environmental Modelling & Software* 14(5):473–491.
- Walker, B., S. Carpenter, J. Anderies, N. Abel, G. Cumming, M. Janssen, J. Norberg, G. D. Peterson, and R. Pritchard. 2002. Resilience management in social-ecological systems: a working hypothesis for a participatory approach. *Ecology And Society* 6(1):14.
- Walker, B., L. Gunderson, A. Kinzig, C. Folke, S. Carpenter, and L. Schultz. 2006. A handful of heuristics and some propositions for understanding resilience in social-ecological systems. *Ecology And Society* 11(1):13.
- Walker, B., and J. A. Meyers. 2004. Thresholds in ecological and social–ecological systems: a developing database. *Ecology And Society* 9(2):3.
- Walras, L. 1874. *Elements of Pure Economics*.
- Walters, C., V. Christensen, S. Martell, and J. Kitchell. 2005. Possible ecosystem impacts of applying MSY policies from single-species assessment. *ICES Journal of Marine Science* 62(3):558–568.
- Walters, C., V. Christensen, and D. Pauly. 1997. Structuring dynamic models of exploited ecosystems from trophic mass-balance assessments. *Reviews in Fish Biology and Fisheries* 7(2):139–172.
- Walters, C. J. 1986. *Adaptive management of renewable resources*. McMillan, New York, New York, USA.
- Walters, C., D. Pauly, V. Christensen, and J. F. Kitchell. 2000. Representing density dependent consequences of life history strategies in aquatic ecosystems: EcoSim II. *Ecosystems* 3(1):70–83.

- Ward, F. A., and D. Beal. 2000. *Valuing nature with travel cost models: A manual (New horizons in environmental economics)*. Edward Elgar.
- Weiner, N. 1948. *Cybernetics: or the control and communication in the animal and the machine*. Cambridge, MA: MIT Press.
- Weiner, N. 1954. *The human use of human beings: Cybernetics and society*. Houghton Mifflin, Boston.
- Weisbrod, G., and B. Weisbrod. 1997. *Assessing the Economic Impact of Transportation Projects*. The National Academies of Sciences, Engineering and Medicine: Transportation Research Board, Washington DC, USA.
- Westley, F. 2001. The devil in the dynamics: adaptive management on the front lines. Pages 333–360 *Panarchy: understanding transformations in human and natural systems*. Island Press, Washington D.C., USA.
- Wong, P. P., I. J. Losada, J.-P. Gattuso, J. Hinkel, A. Khattabi, K. McInnes, Y. Saito, and A. Sallenger. 2014. *Coastal systems and low-lying areas*. In: *Climate Change 2014: Impacts, Adaptation, and Vulnerability. Part A: Global and Sectoral Aspects. Contribution of Working Group II to the Fifth Assessment Report of the Intergovernmental Panel on Climate Change*. Cambridge University Press, Cambridge, United Kingdom and New York, NY, USA.
- Yeh, S.-C., C.-A. Wang, and H.-C. Yu. 2006. Simulation of soil erosion and nutrient impact using an integrated system dynamics model in a watershed in Taiwan. *Environmental Modelling & Software* 21(7):937–948.
- Yodzis, P. 1998. Local trophodynamics and the interaction of marine mammals and fisheries in the Benguela ecosystem. *Journal of Animal Ecology* 67(4):635–658.
- Yukselen, M. A., B. Calli, O. Gokyay, and A. Saatci. 2003. Inactivation of coliform bacteria in Black Sea waters due to solar radiation. *Environment international* 29(1):45–50.
- Zalasiewicz, J., M. Williams, A. Haywood, and M. Ellis. 2011. The Anthropocene: a new epoch of geological time? *Philosophical transactions. Series A, Mathematical, physical, and engineering sciences* 369(1938):835–41.
- Zoppou, C. 2001. Review of urban storm water models. *Environmental Modelling & Software* 16(3):195–231.