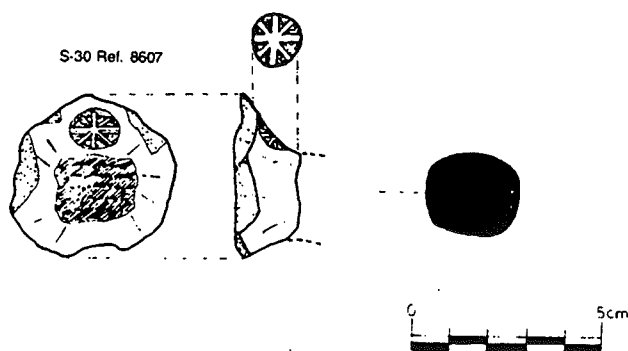

Fig. 6.3. Cal Ros de les Cabres
(JARREGA 1987).



Estampeta sobre àmfora ibèrica (Can
Modolell). (GARCIA-PUJOL 1985).



Estampeta sobre dolium de Burriac
(RIBAS-LLADO 1977-78).

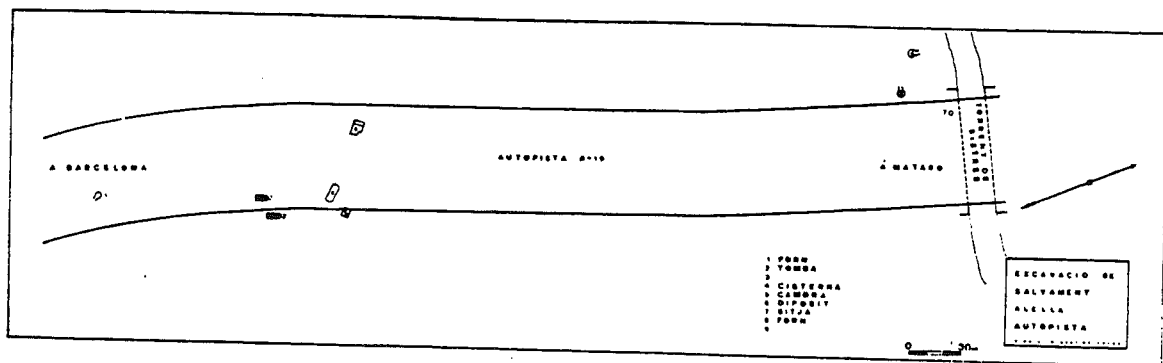

Fig. 7. Alella Autopista (PREVOSTI 1981b).

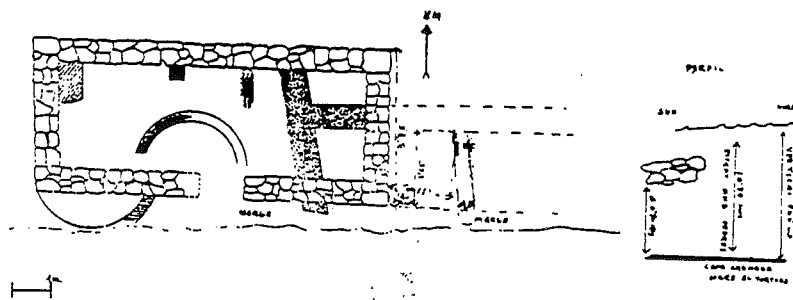

Fig. 8. Veral de Vallmora (PREVOSTI 1981b).

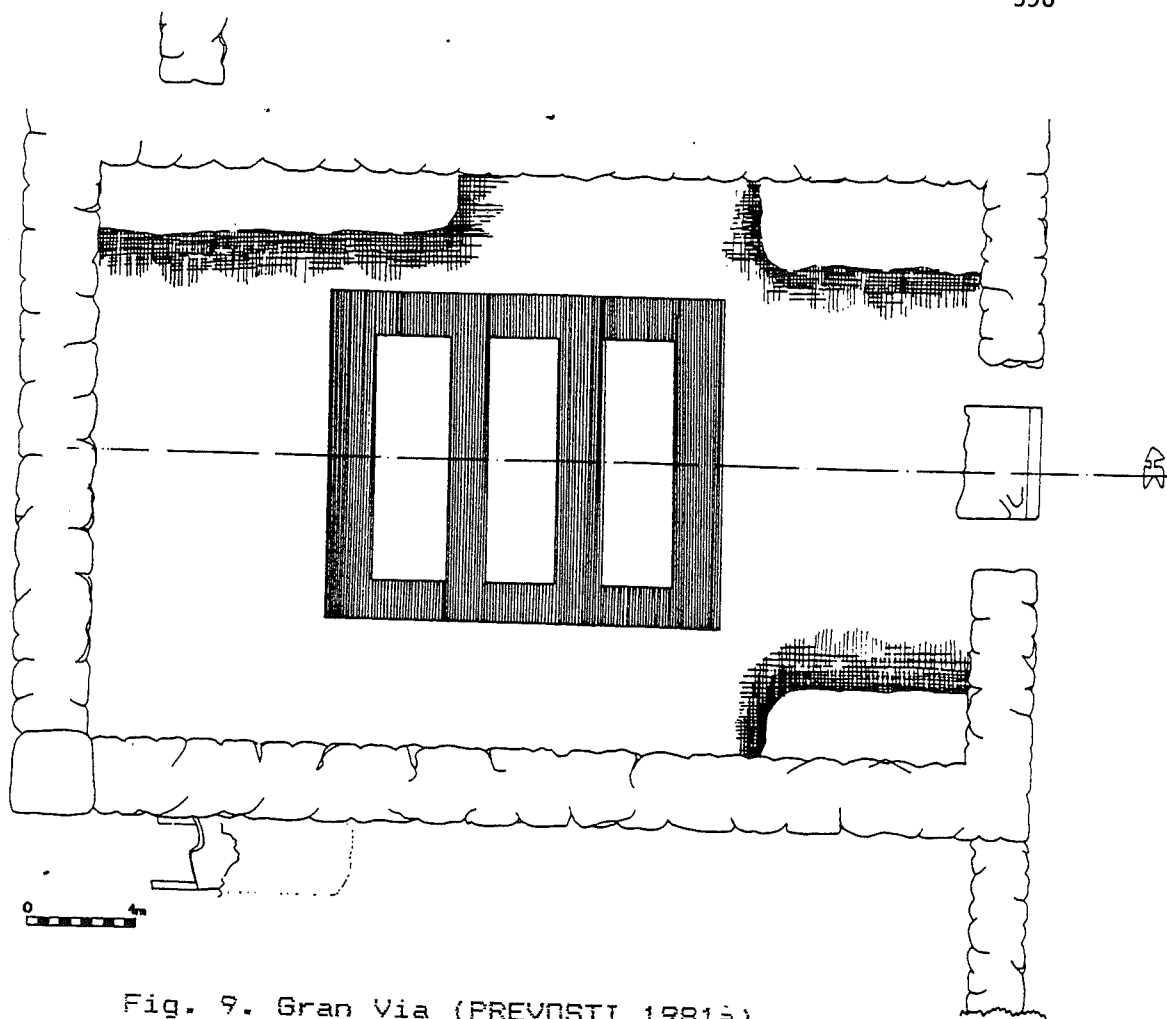

Fig. 9. Gran Via (PREVOSTI 1981a).

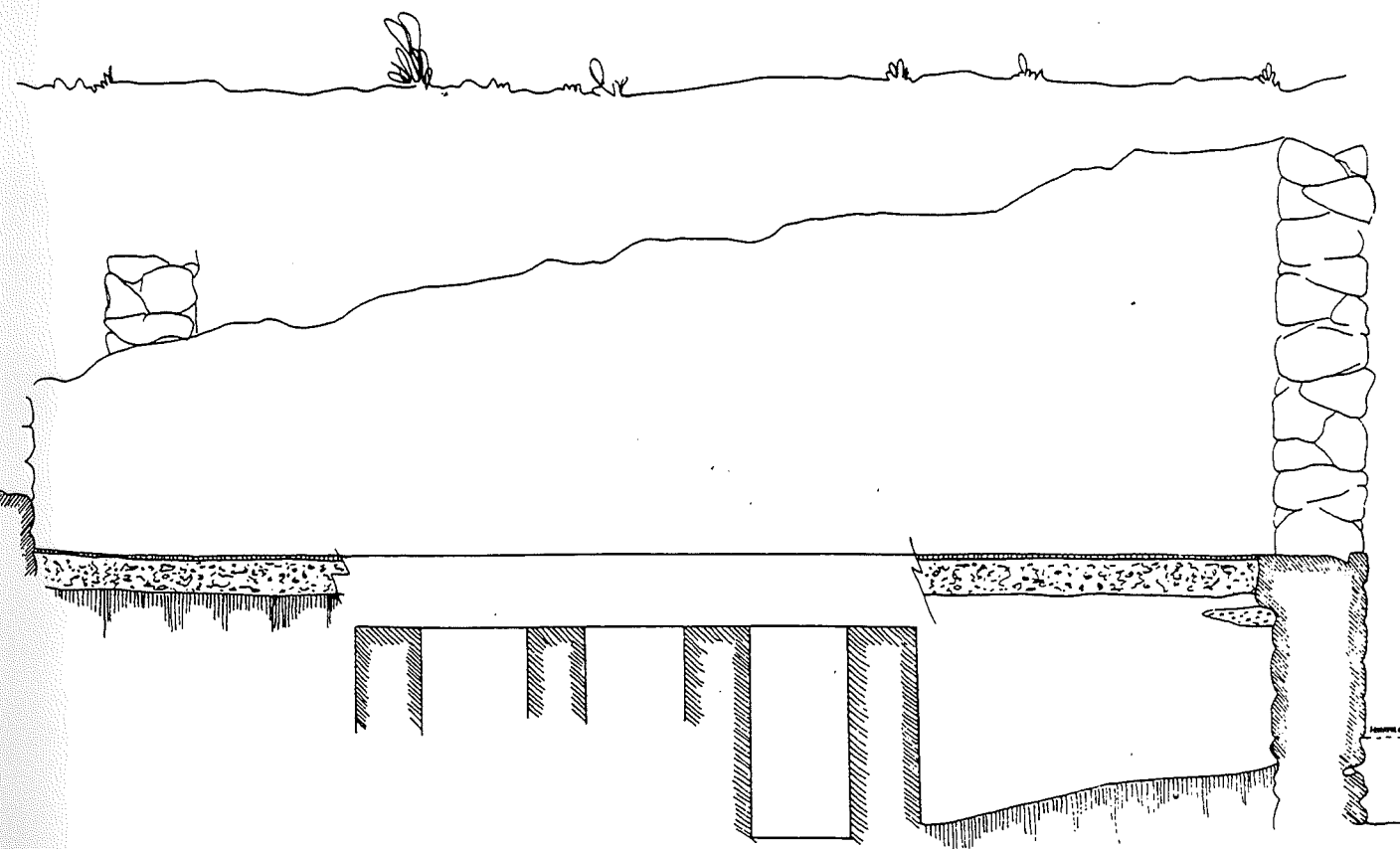



Fig. 10.1. Jardí Park. Estampeta sobre dolium. Calc i interpretació dels signes (Inèdita, A.E.C.C. de Premià.

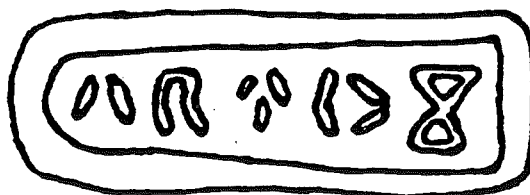
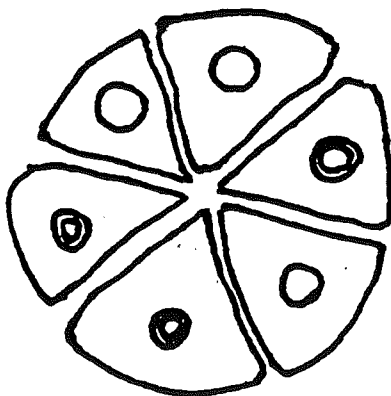



Fig. 10.2. Jardí Park. Estampeta sobre dolium
Calc i interpretació (Inèdita, A.E.C.C. de Premià).



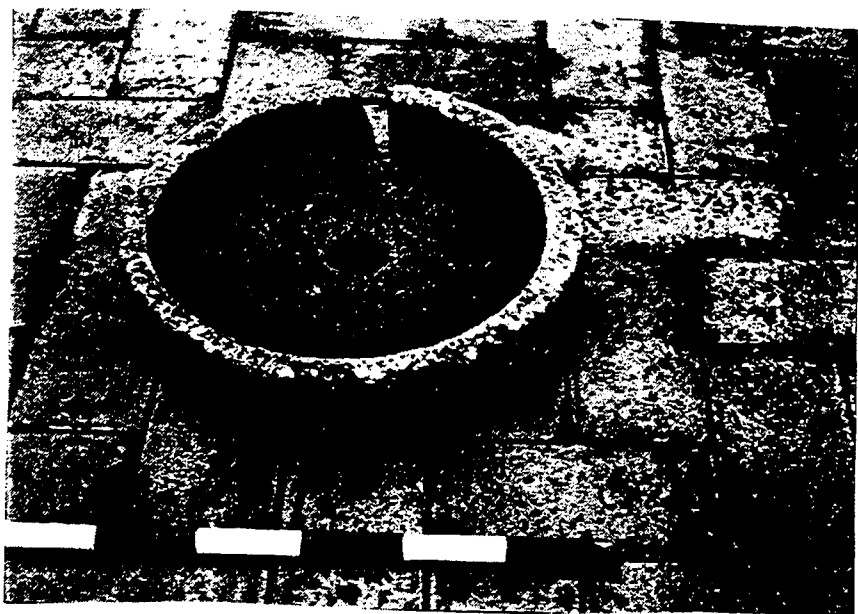

Fig. 11.3 Cadira del Bisbe (COLL 1987).



Fig. 11.4 Cadira del Bisbe (COLL 1987).

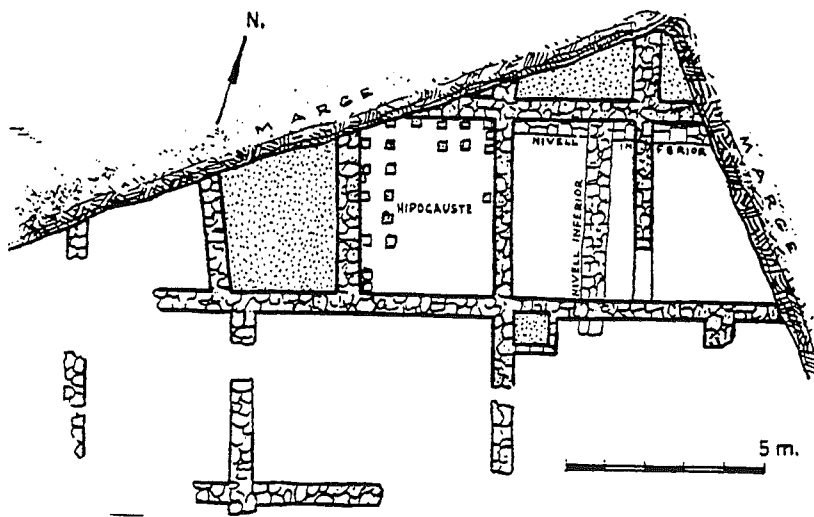

Fig. 14.1 Capella de St. Crist (PREVOSTI 1981a).

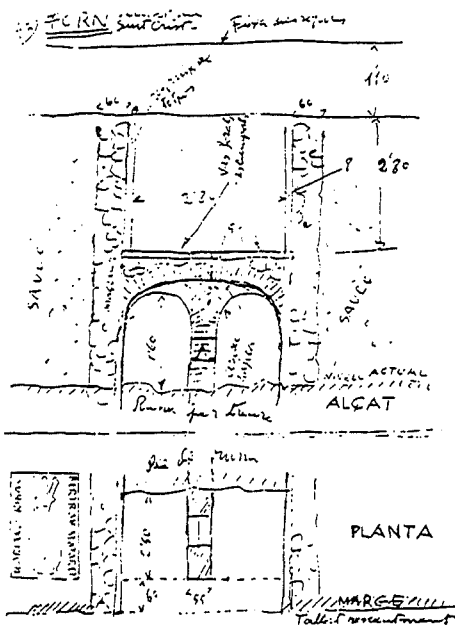

Fig. 14.2 Capella de St. Crist (PREVOSTI 1981a).

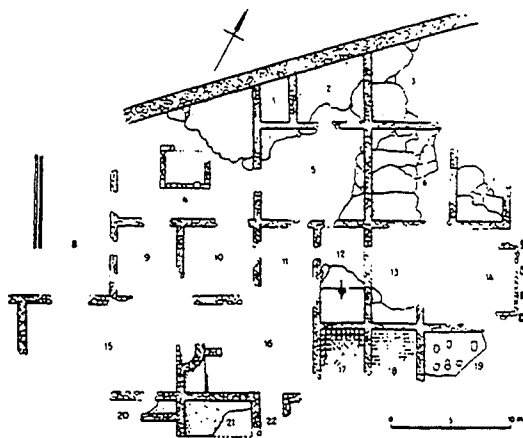

Fig. 14.3 Capella de St. Crist (PREVOSTI 1981a).

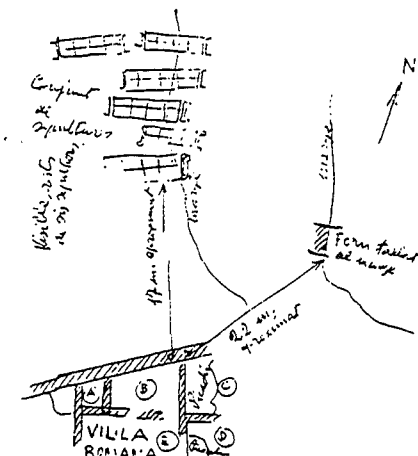

Fig. 14.4 Capella de St. Crist (PREVOSTI 1981a).

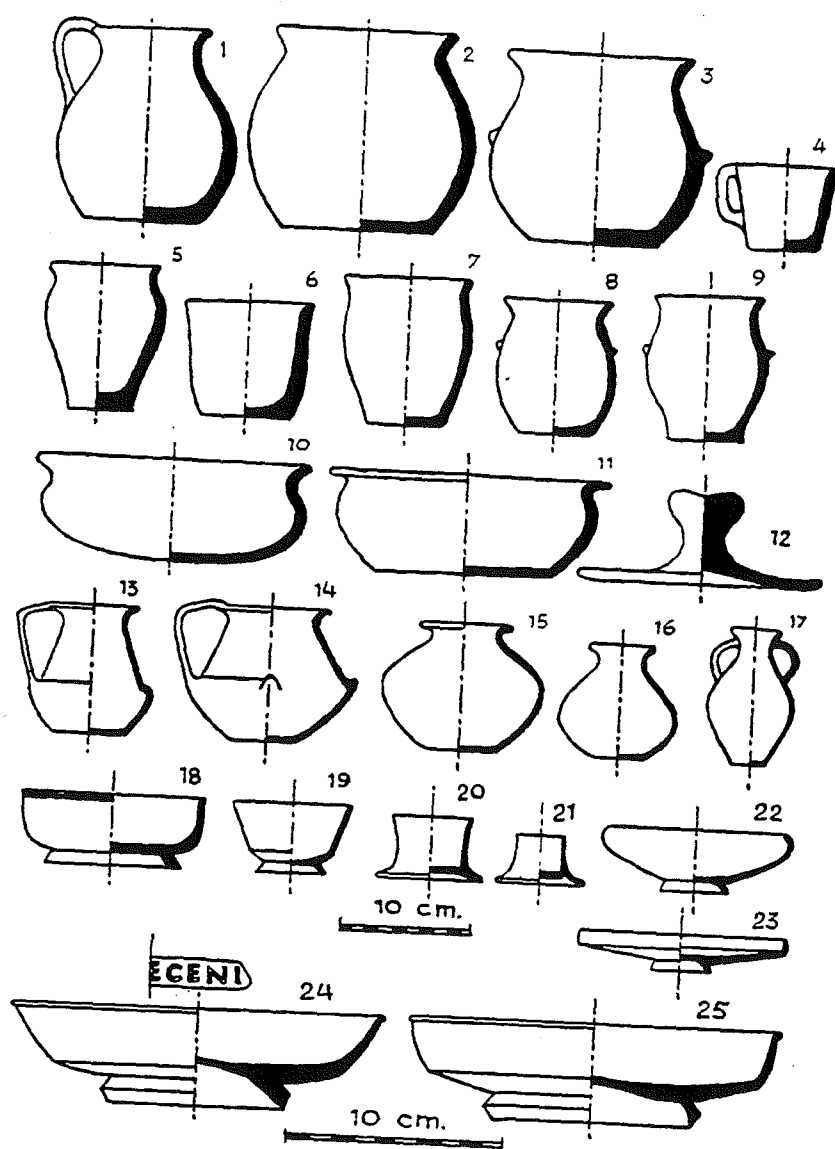

Fig. 16. Poblats a 200 m. del Cementiri.
(RIBAS 1988).

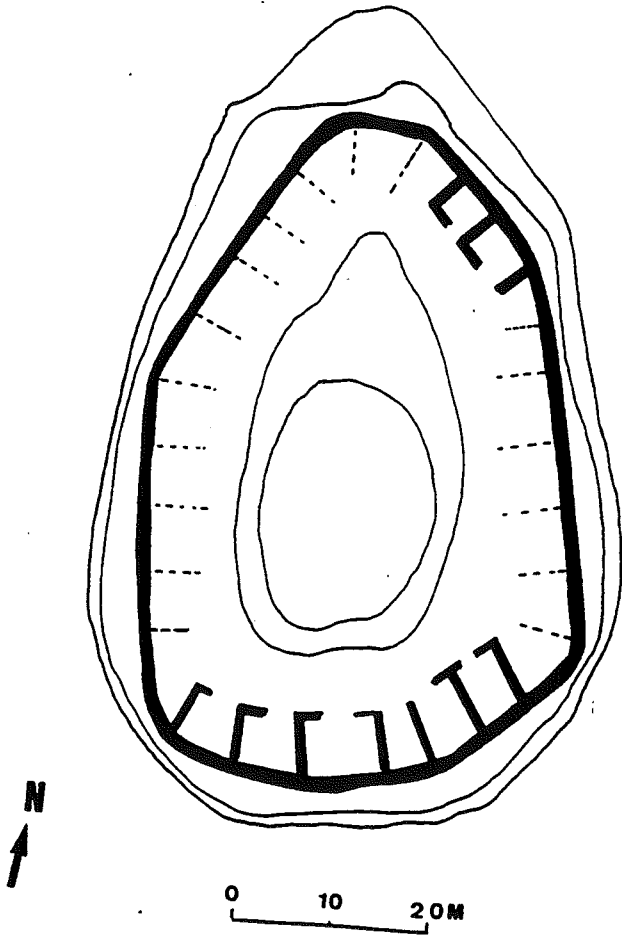

Fig. 17 Turó Gros de Cèlecs.
(SANMARTI-SANTACANA 1991).

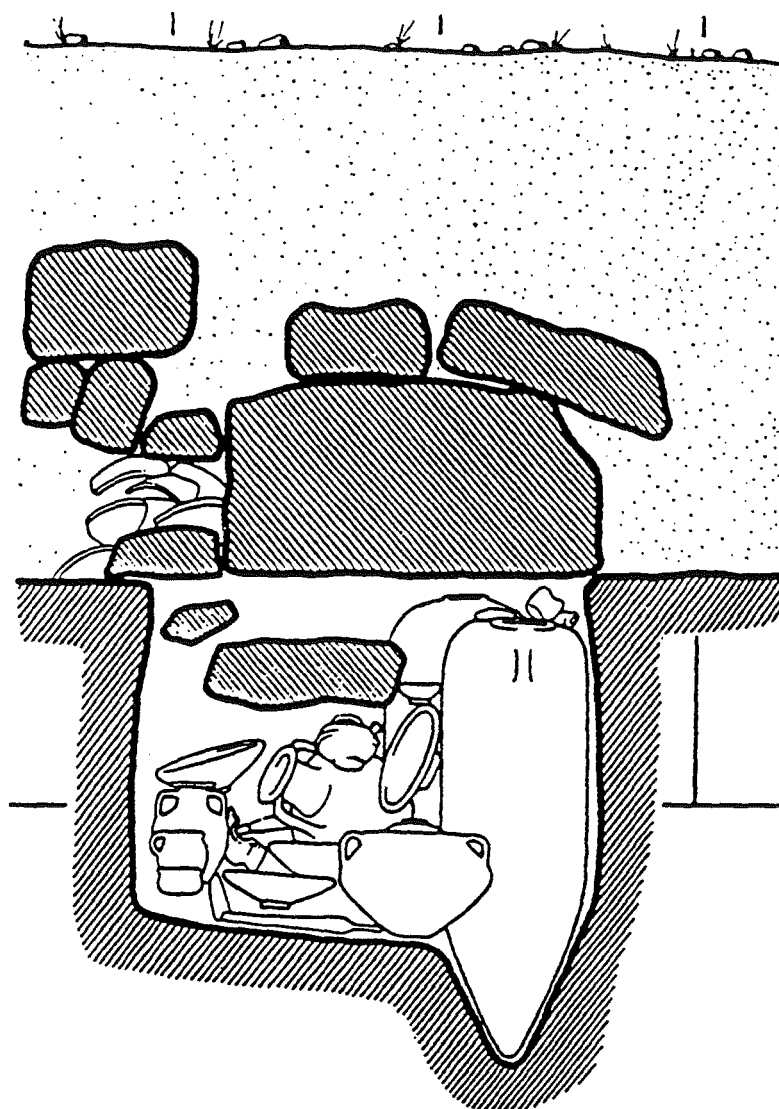

Fig. 18. Can Rodón de l'Hort.
(PUJOL 1989).

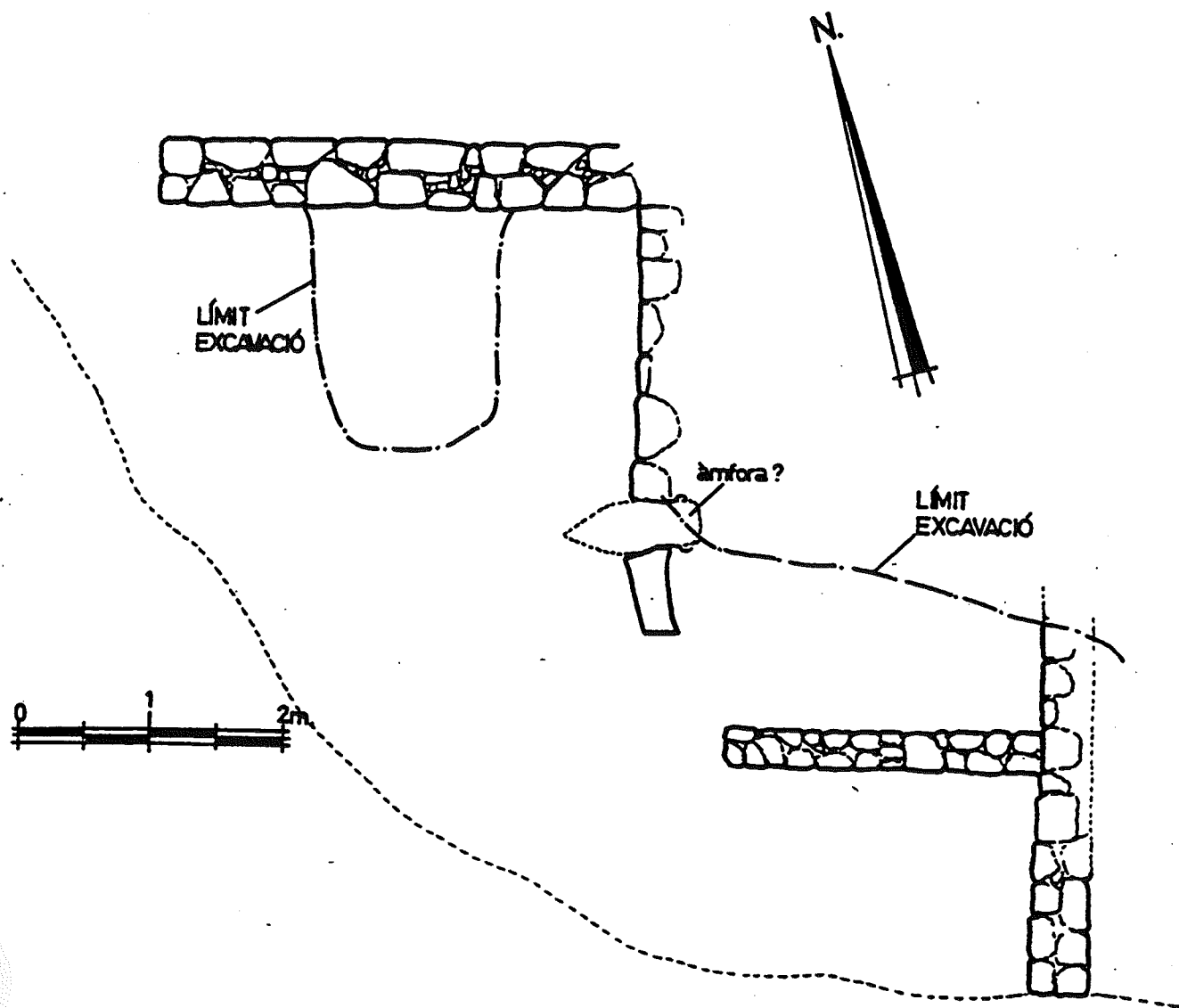

Fig. 19.1. Turó de Dos Pins (Habitat).
(LLEONART 1979).

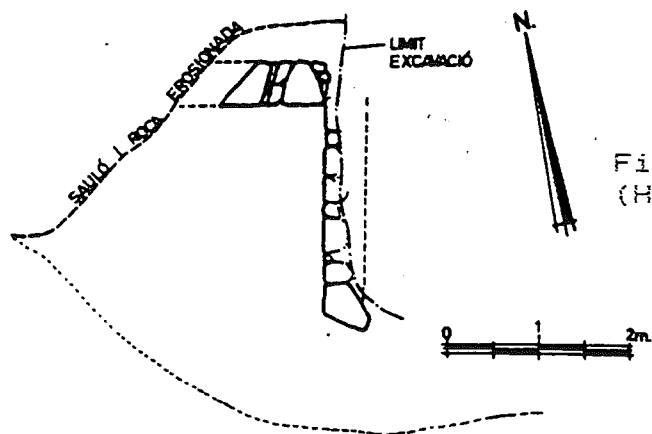

Fig. 19.2. Turó de Dos Pins
(Habitat). (LLEONART 1979).

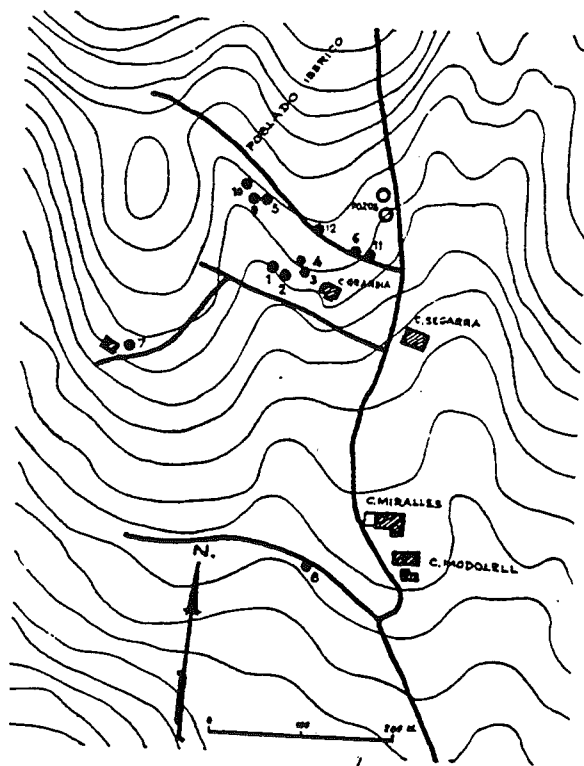

Fig. 20.1. Can Grandia (RIBAS-MARTIN 1961).

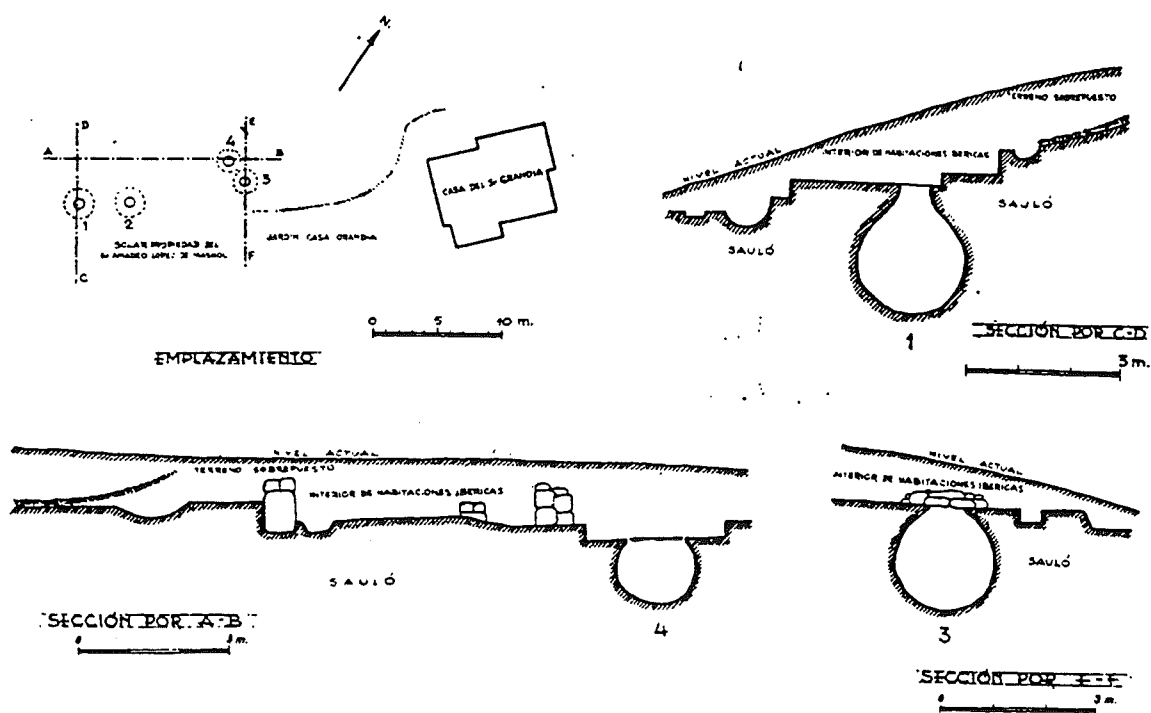

Fig. 20.2. Can Grandia (RIBAS-MARTIN 1961).

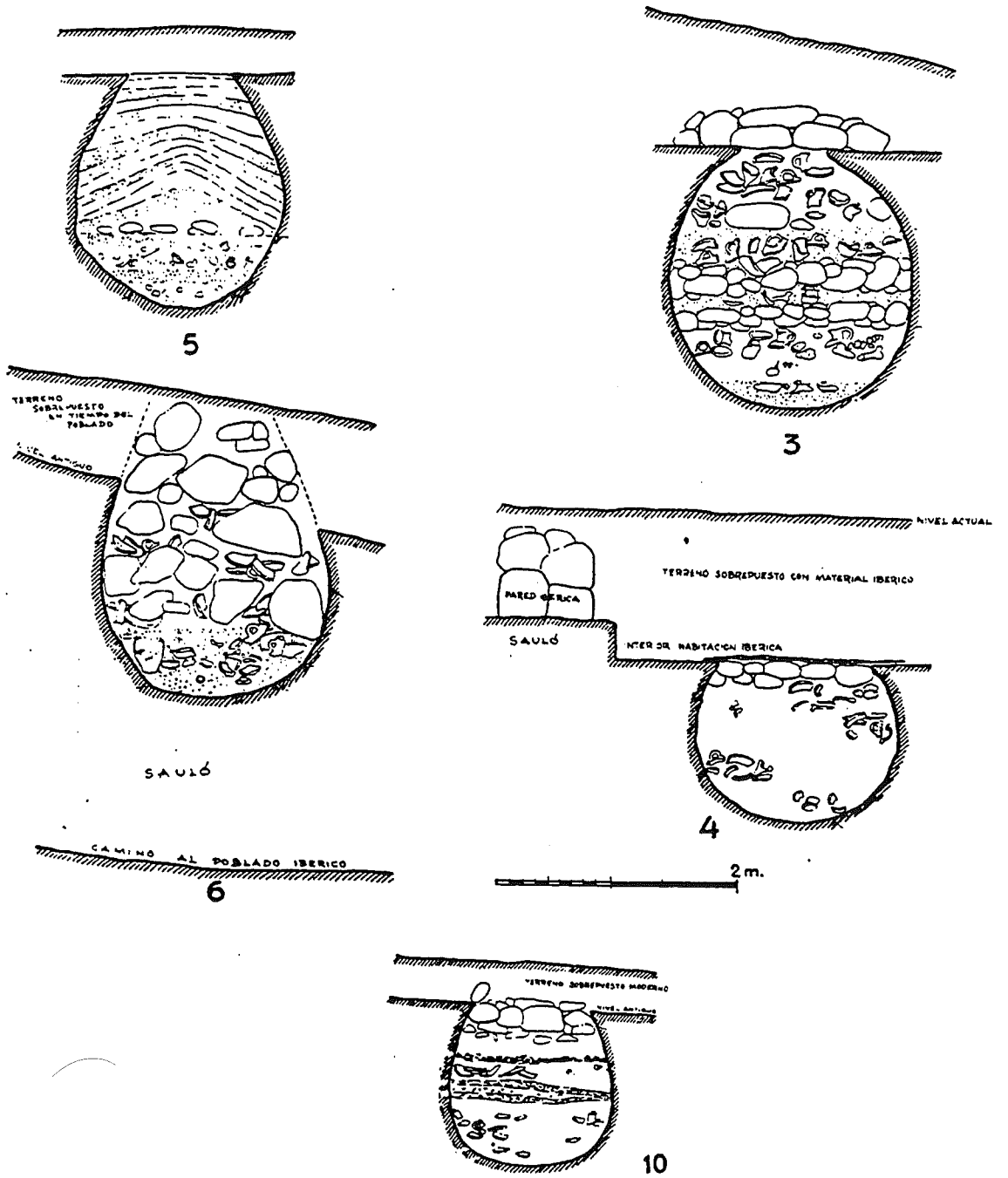

Fig. 20.2. Can Grandia (RIBAS-MARTIN 1961).

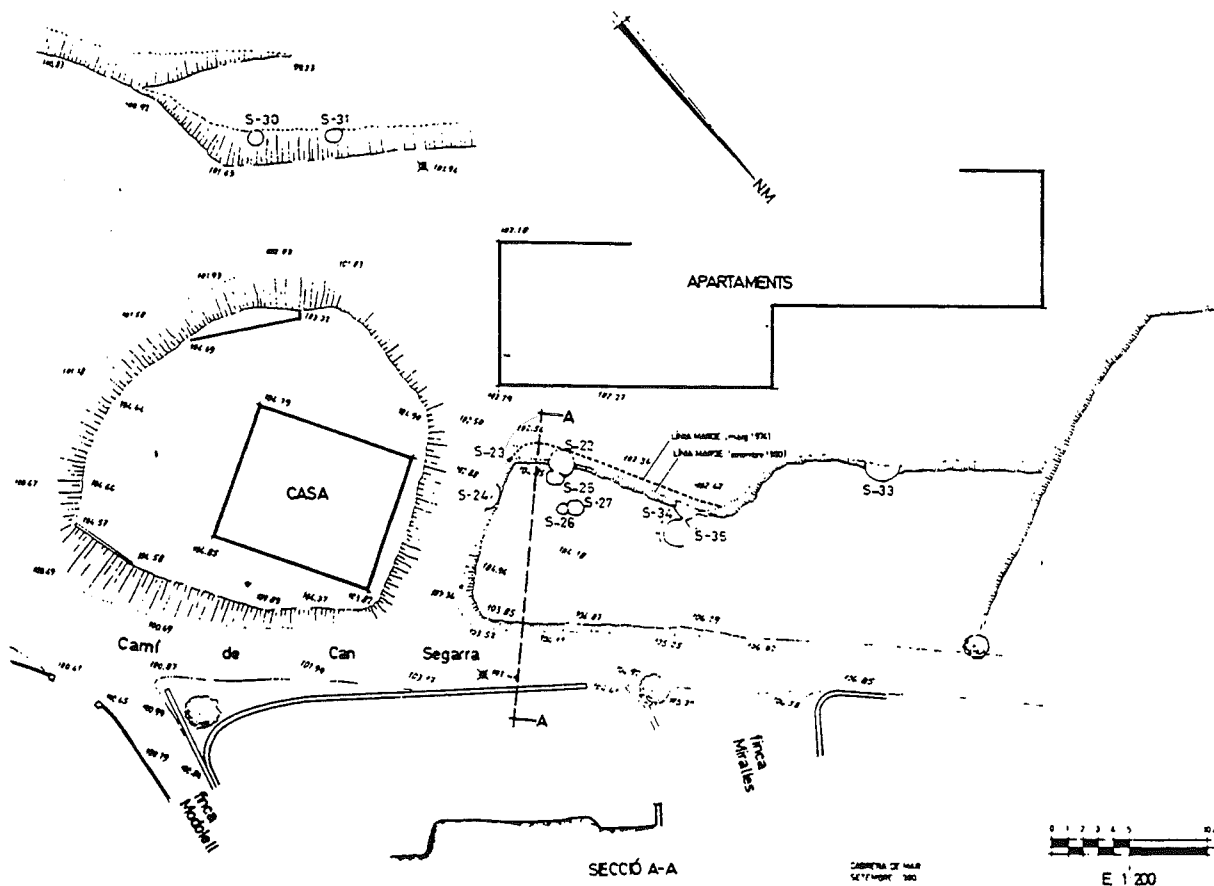

Fig. 21.1. Can Modolell I (GARCIA-PUJOL 1985).

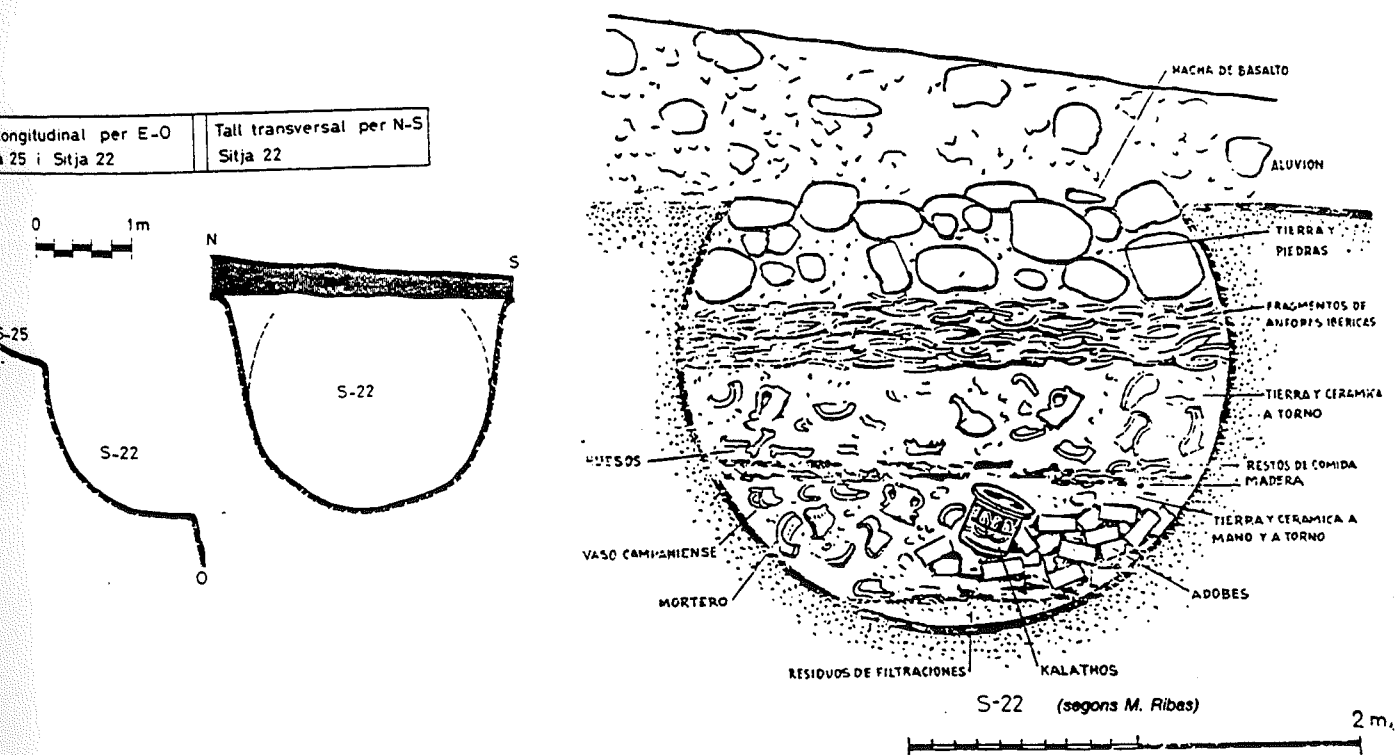

Fig. 21.2. Can Modolell I (GARCIA-PUJOL 1985).

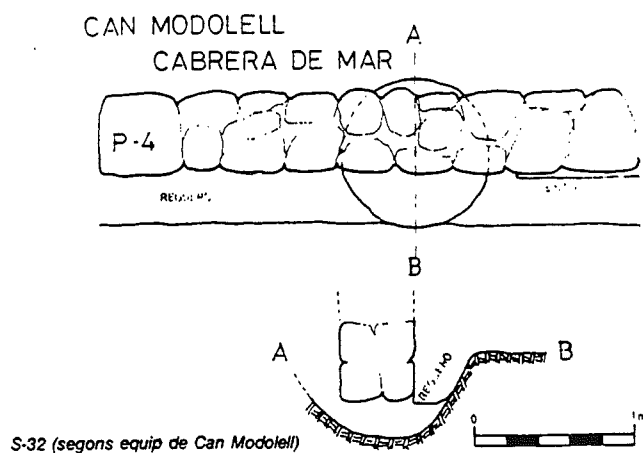

Fig. 21.3. Can Modolell I (GARCIA-PUJOL 1985).

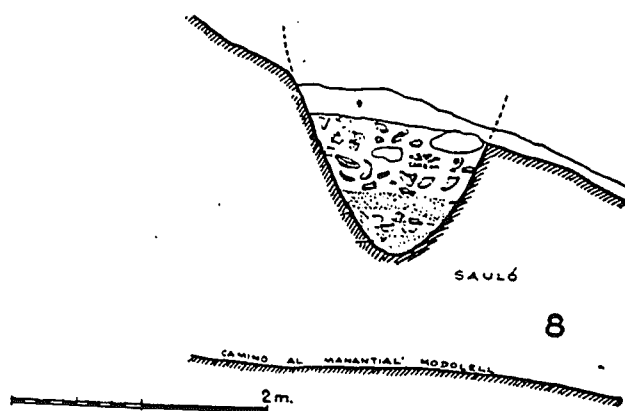

Fig. 21.4. Can Modolell I (RIBAS-MARTIN 1961).

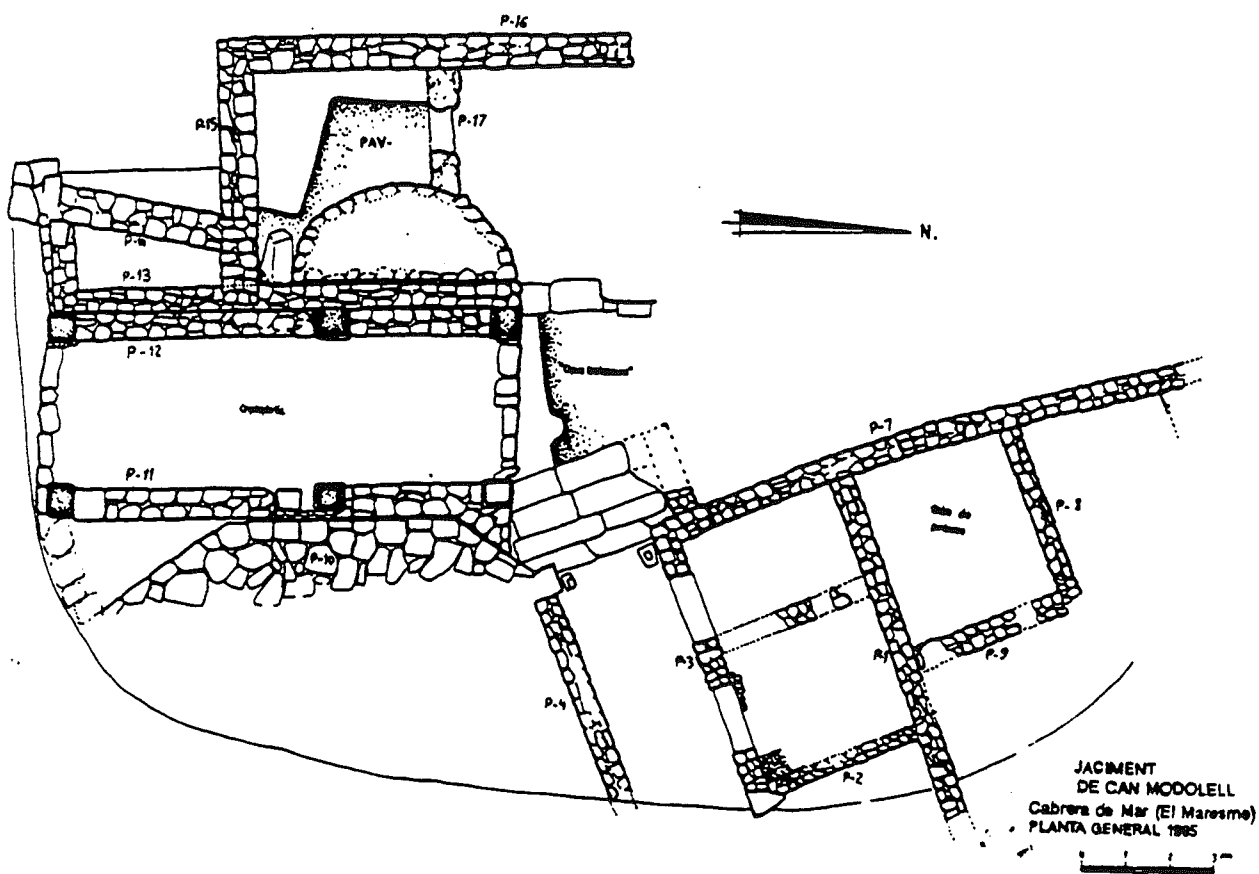

Fig. 22. Can Modolell II
(BONAMUSA ET ALII en premsa).

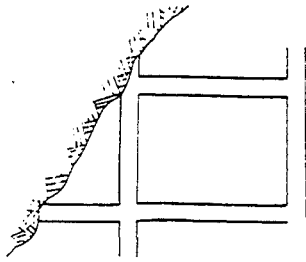

Fig. 23. Can Mateu
(PREVOSTI 1981a).

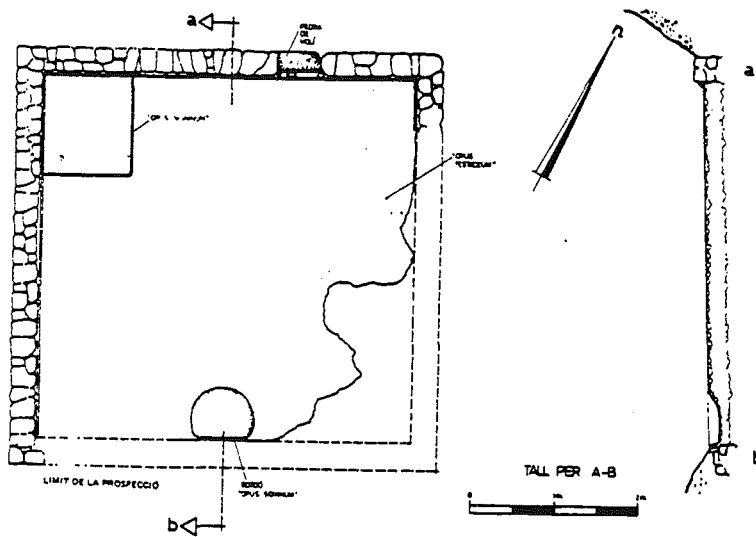

Fig. 24. Can Xacó (PREVOSTI 1981a).

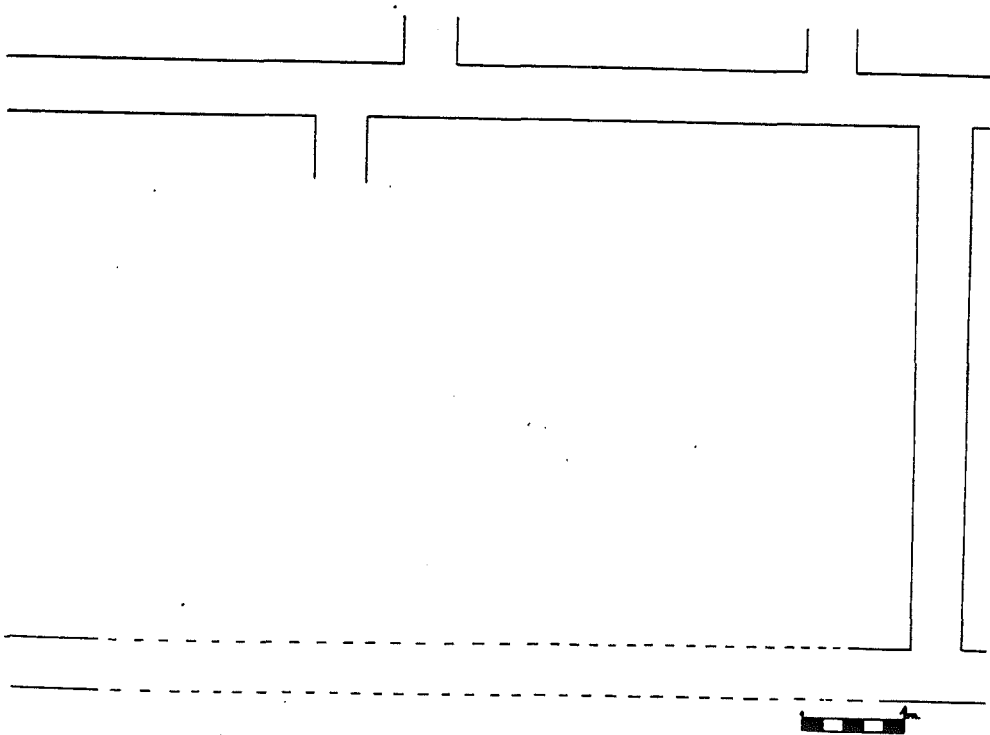

Fig. 25. Camí del Mig (PREVOSTI 1981a).

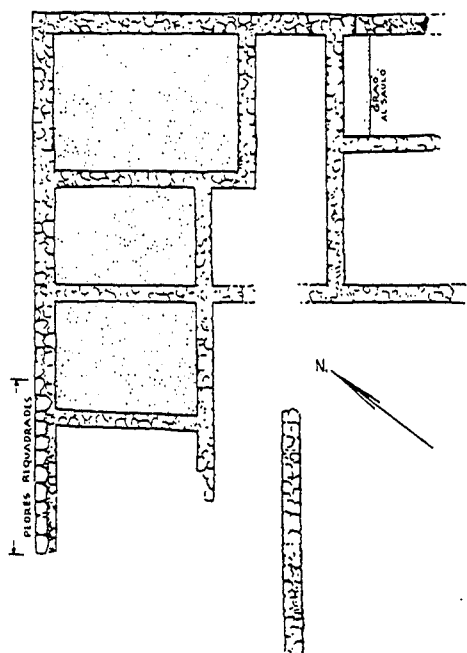

Fig. 26. Prop de Can Mora
(PREVOSTI 1981a).

ESCALA 1:100

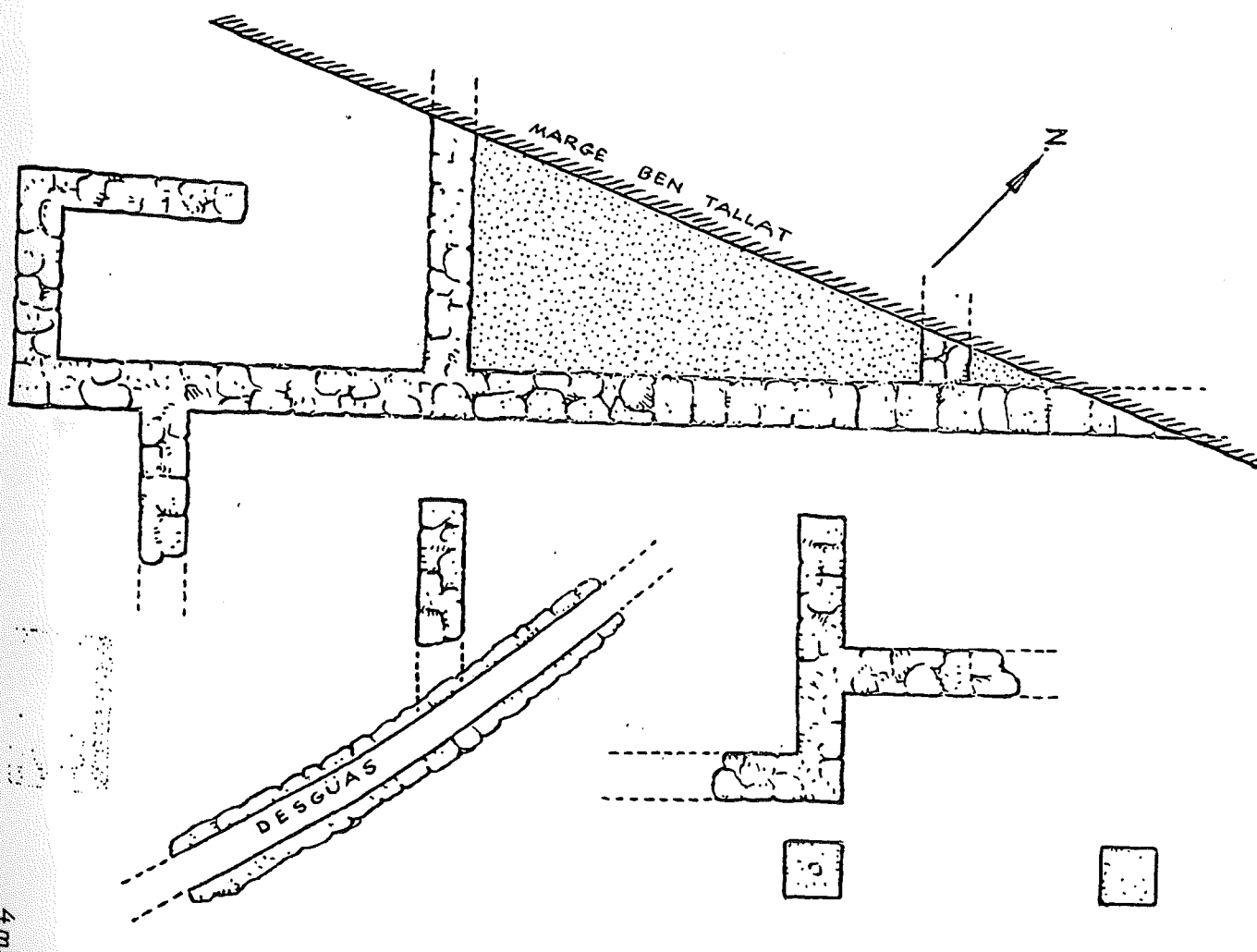
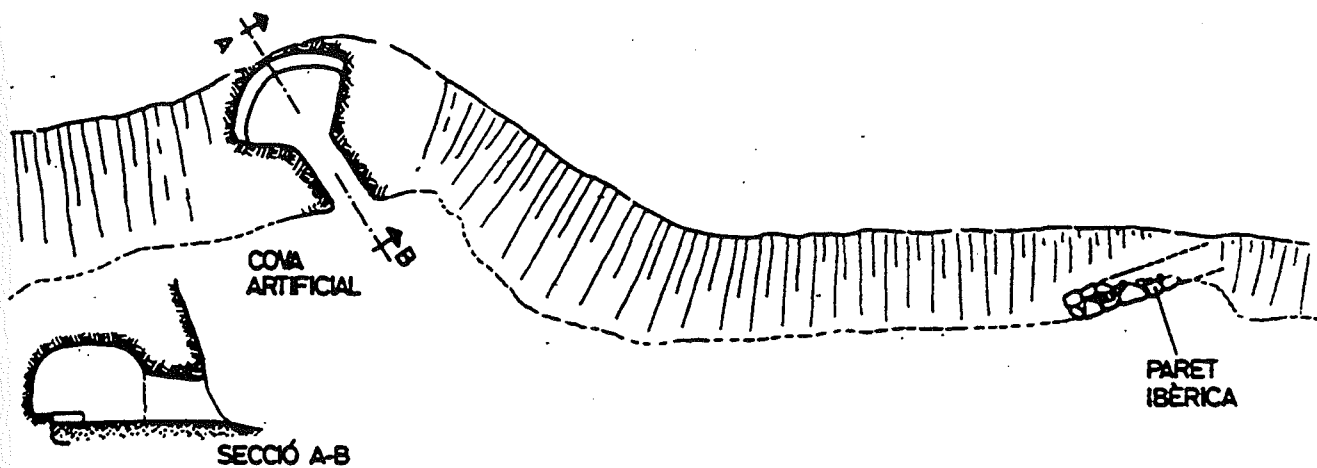

Fig. 27. Sta. Margarida de Cabrera
(PREVOSTI 1981a).



carretera d'urbanització

0 1 2 3 4 5m.

Fig. 28. La Barceloneta (LLEONART 1979).

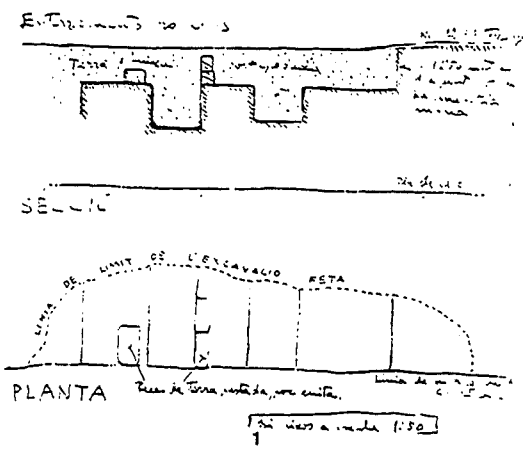

Fig. 29.1. Can Notxa (PREVOSTI 1981a).

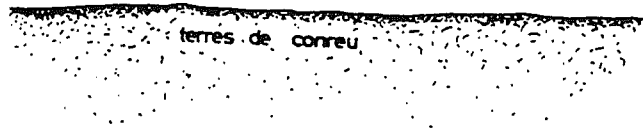

Fig. 29.2. Can Notxa (MESTRE 1978).

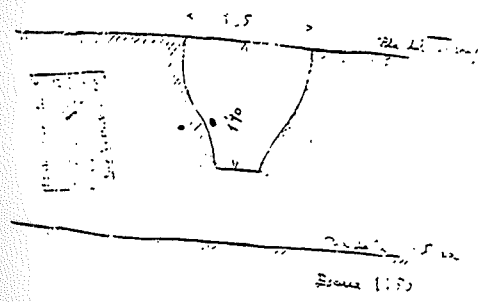
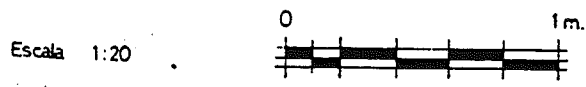
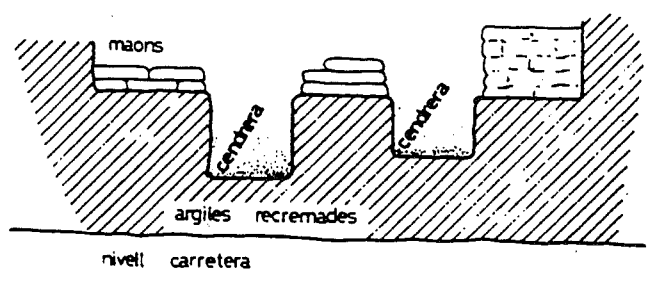
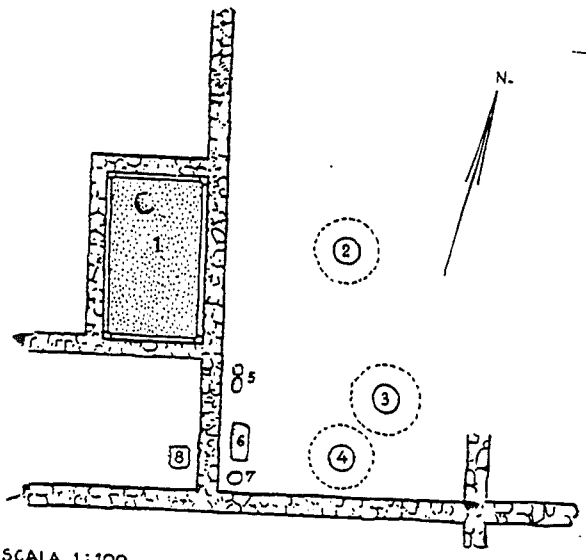

Fig. 29.3. Can Notxa (PREVOSTI 1981a).



ESCALA 1:100
1 DIPÒSIT AMB PICADIS
2-3-4 SITGES FETS AL SAULÓ (245m. PÒDÀRIA)
5-6-7-8 FORATS FETS AL SAULÓ

Fig. 29.4. Can Notxa (PREVOSTI 1981a).

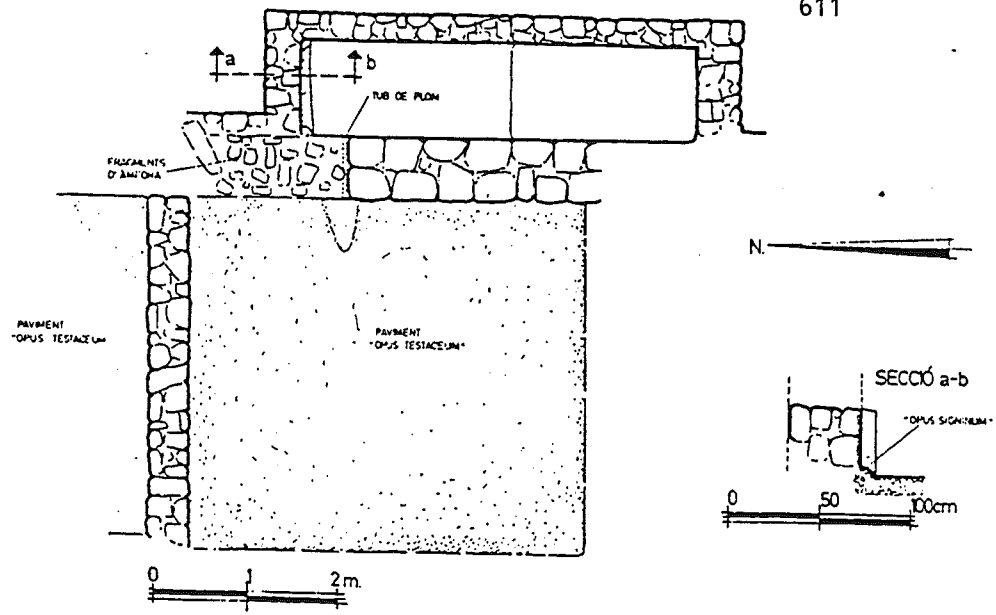

Fig. 30. Can Madà (MESTRE 1979).

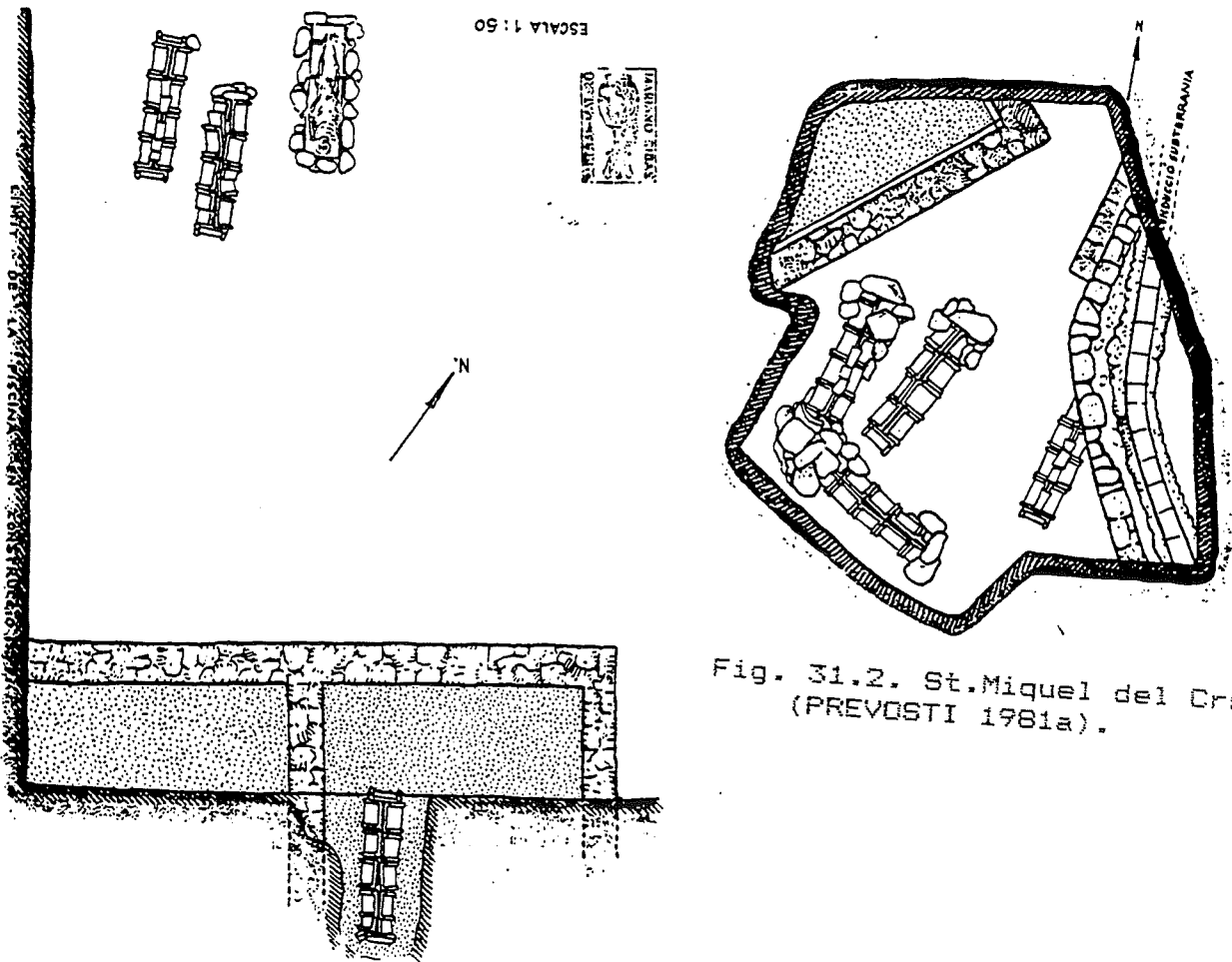

Fig. 31.2. St. Miquel del Cros (PREVOSTI 1981a).

Fig. 31.1. St. Miquel del Cros (PREVOSTI 1981a).

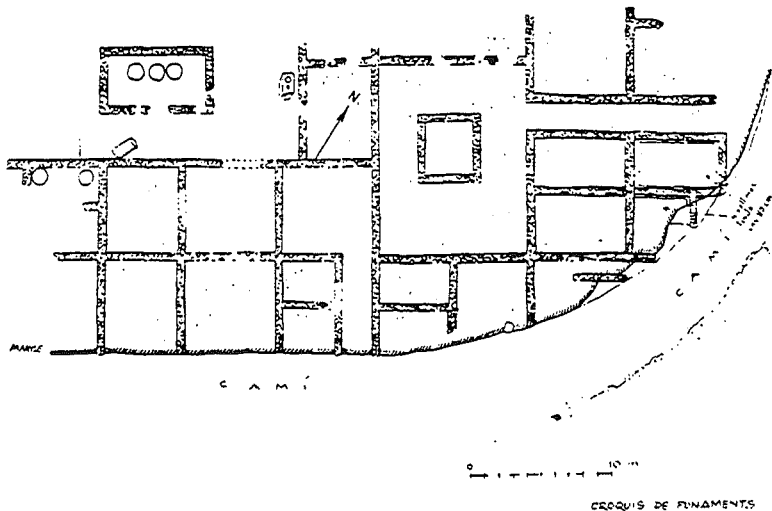

Fig. 32.1 Hotel Delfin (PREVOSTI 1981a).

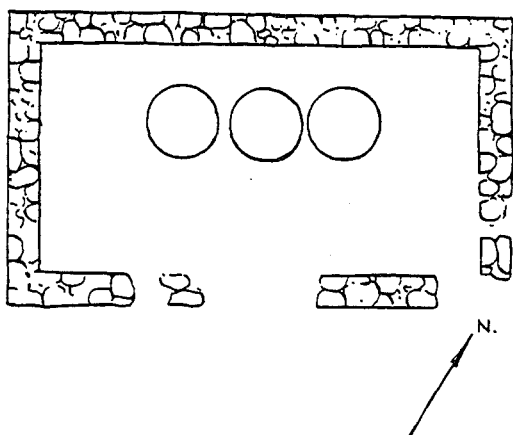

Fig. 32.2 Hotel Delfin (PREVOSTI 1981a).

FAÇANA POSTERIOR DE L'EDIFICI ACTUAL

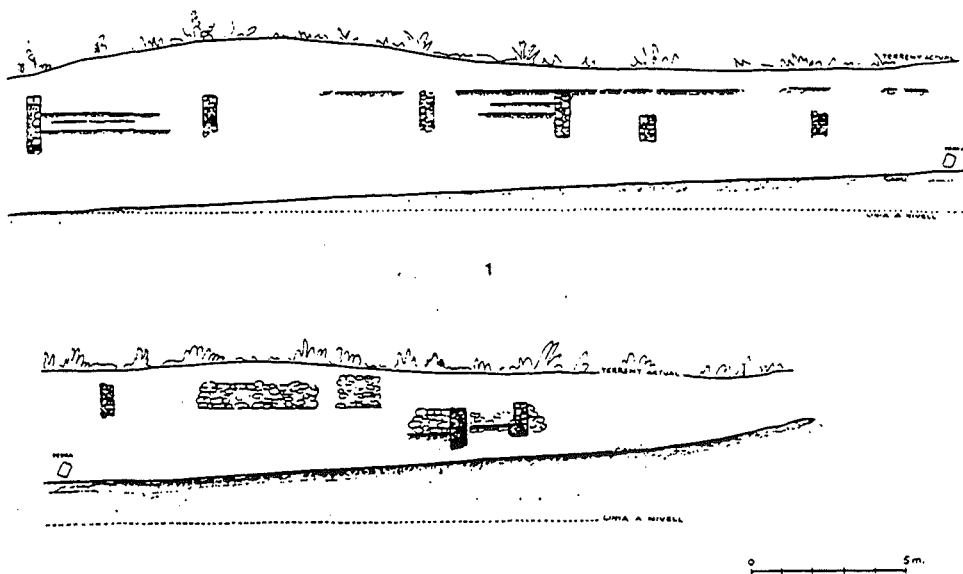

Fig. 32.3 Hotel Delfin (PREVOSTI 1981a).

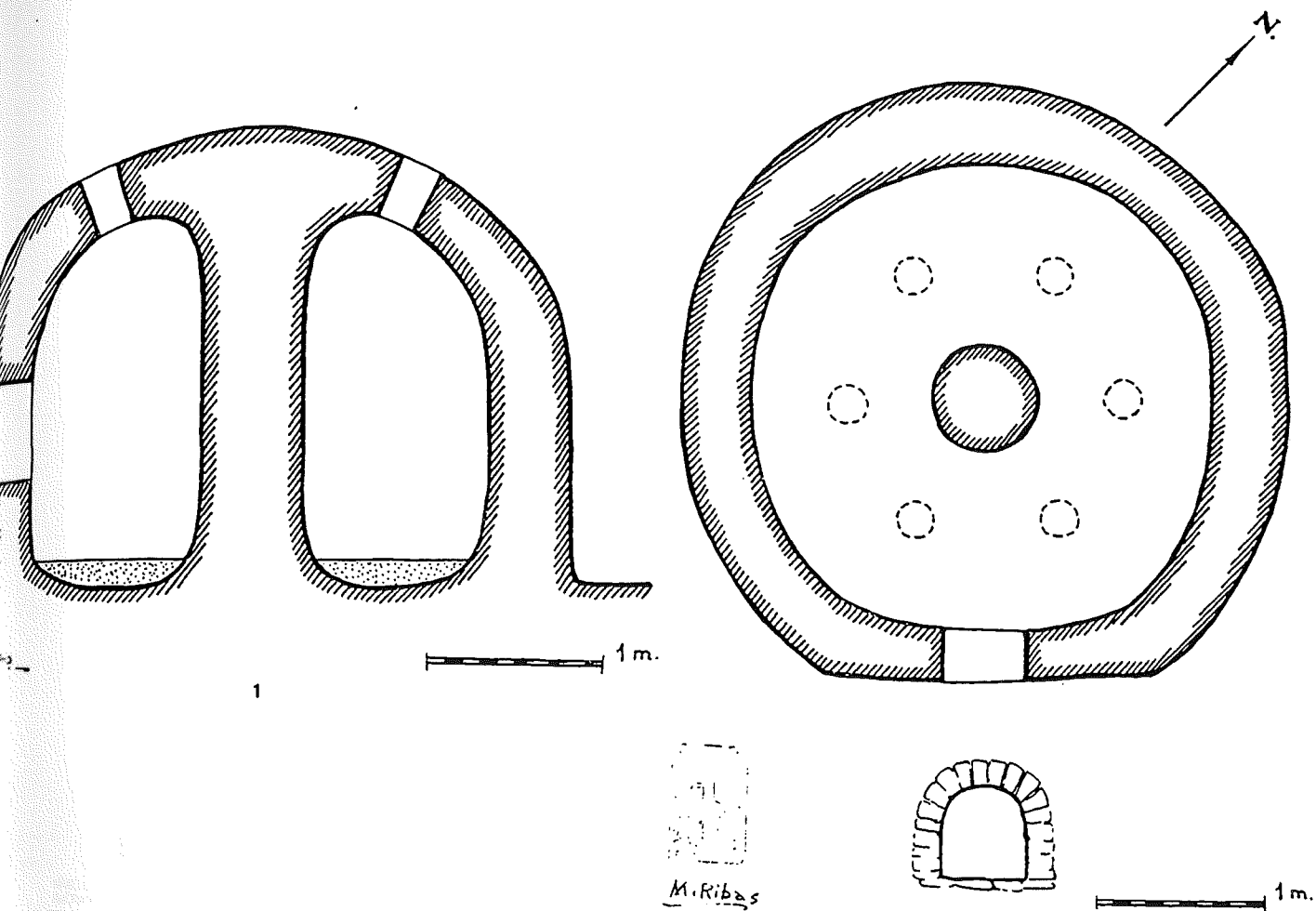

Fig. 32.4 Hotel Delfin (PREVOSTI 1981a)

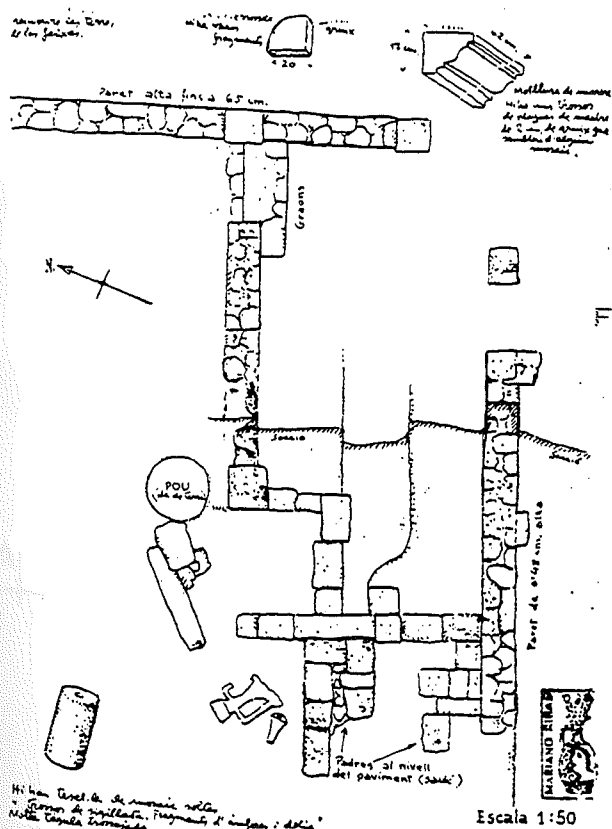

Fig. 33. Can Dordeta (PREVOSTI 1981a).

Hi ha un Canal de drenatge a la
 part superior de la planta.
 Aquesta planta representa el conjunt de la
 planta baixa i primera planta.

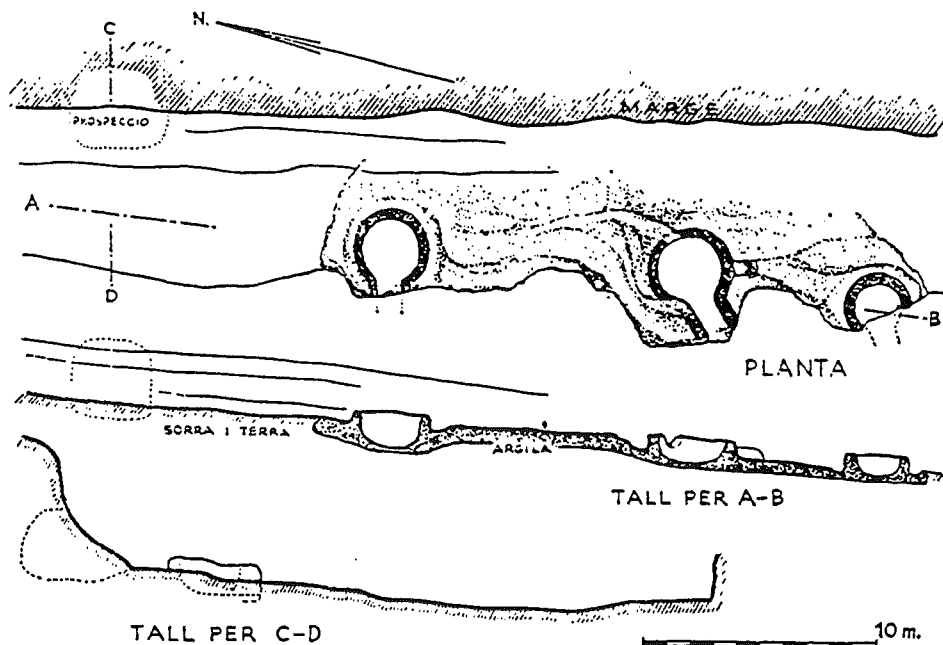

Fig. 34.1. Forns de St. Simó o Sta. Cecília (RIBAS 1983-84).

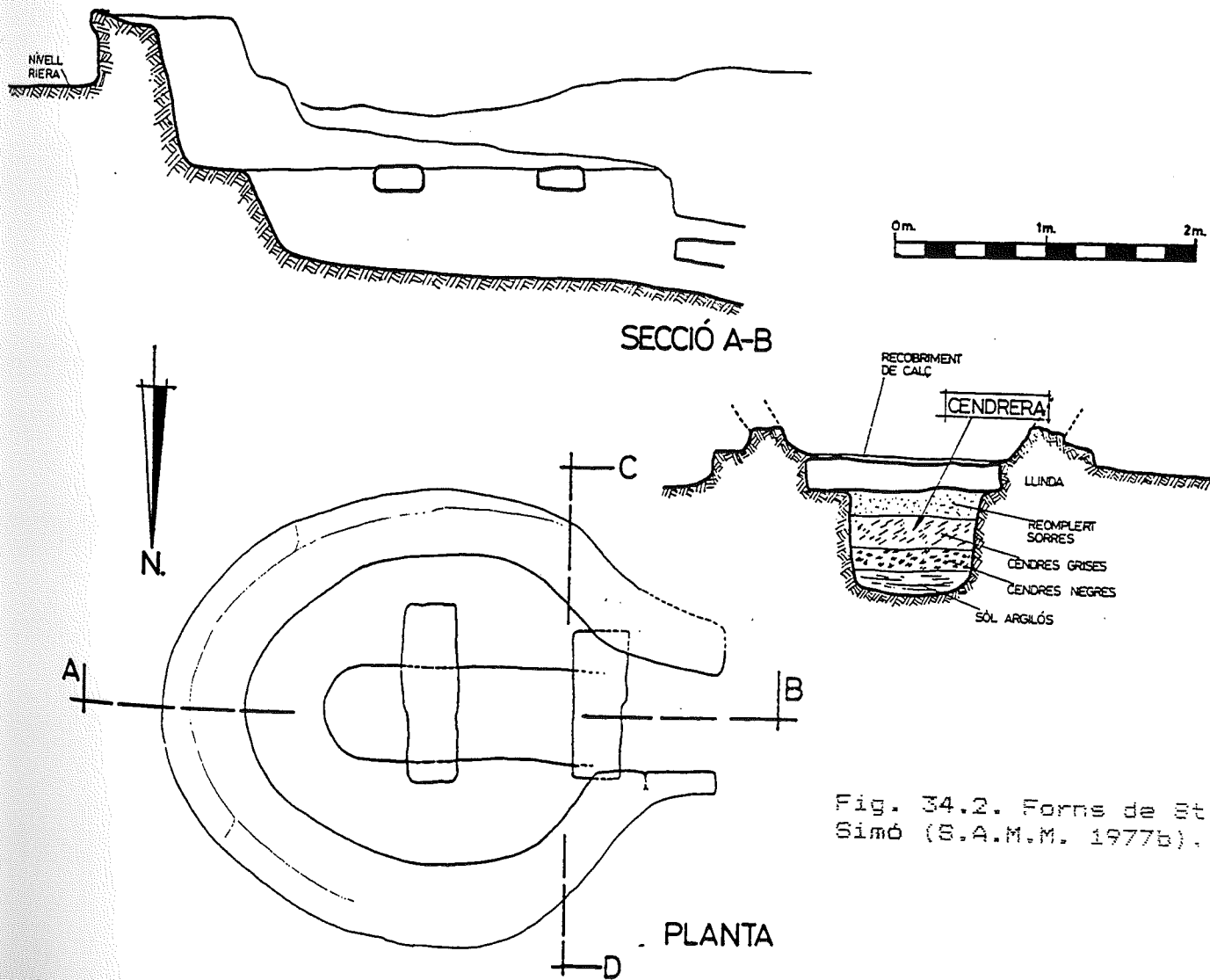

Fig. 34.2. Forns de St. Simó (S.A.M.M. 1977b).

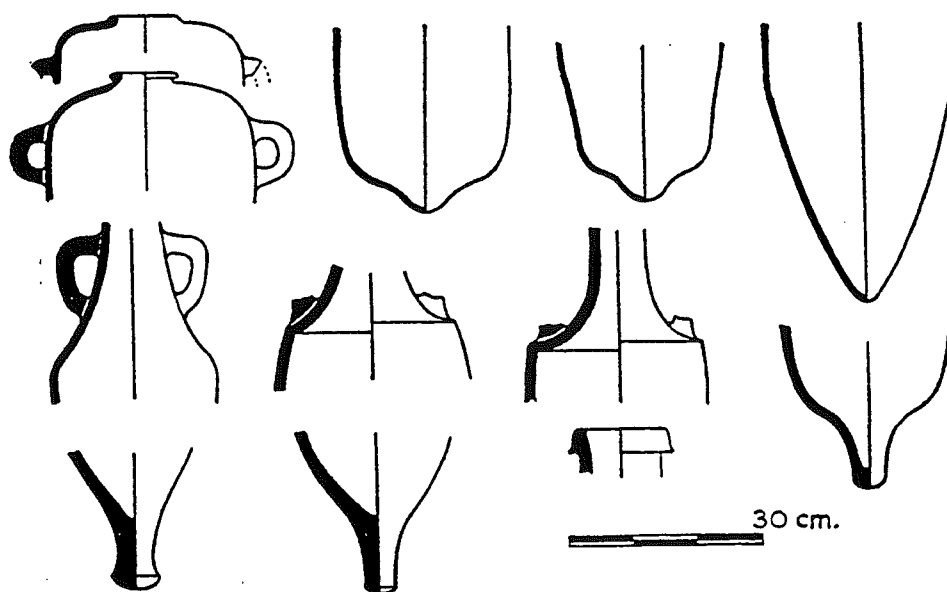

Fig. 34.3. Forns de St. Simó o Sta. Cecília
(RIBAS 1983-84).

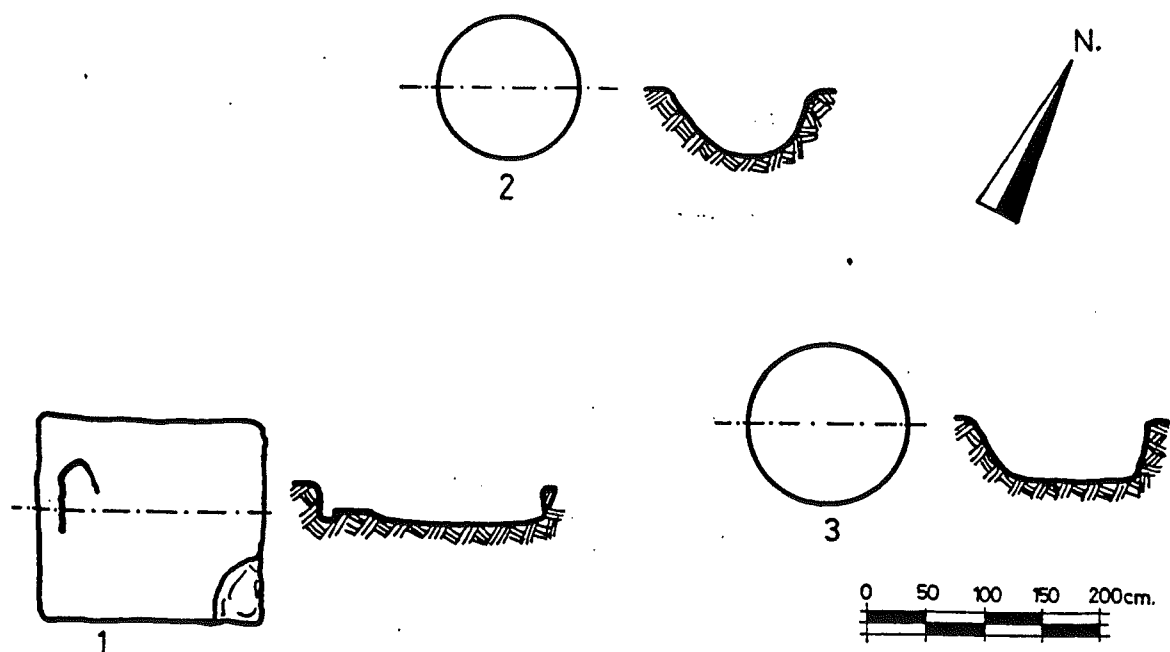

Fig. 35. Propietat del Sr. Farina
(S.A.M.M. 1977b).

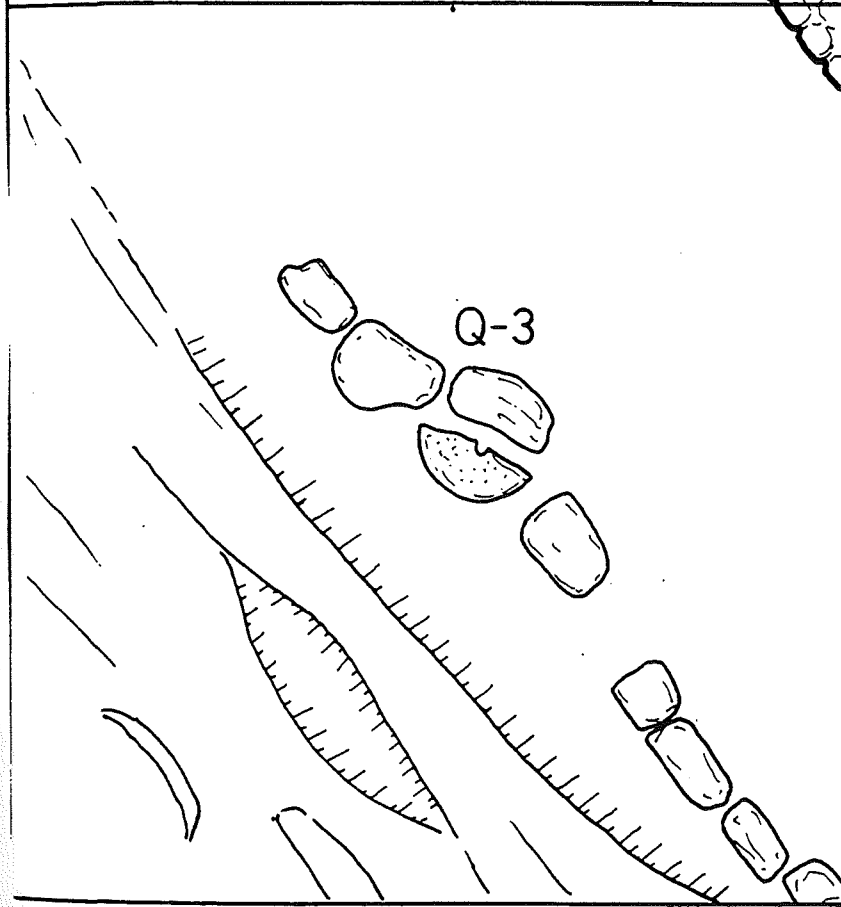
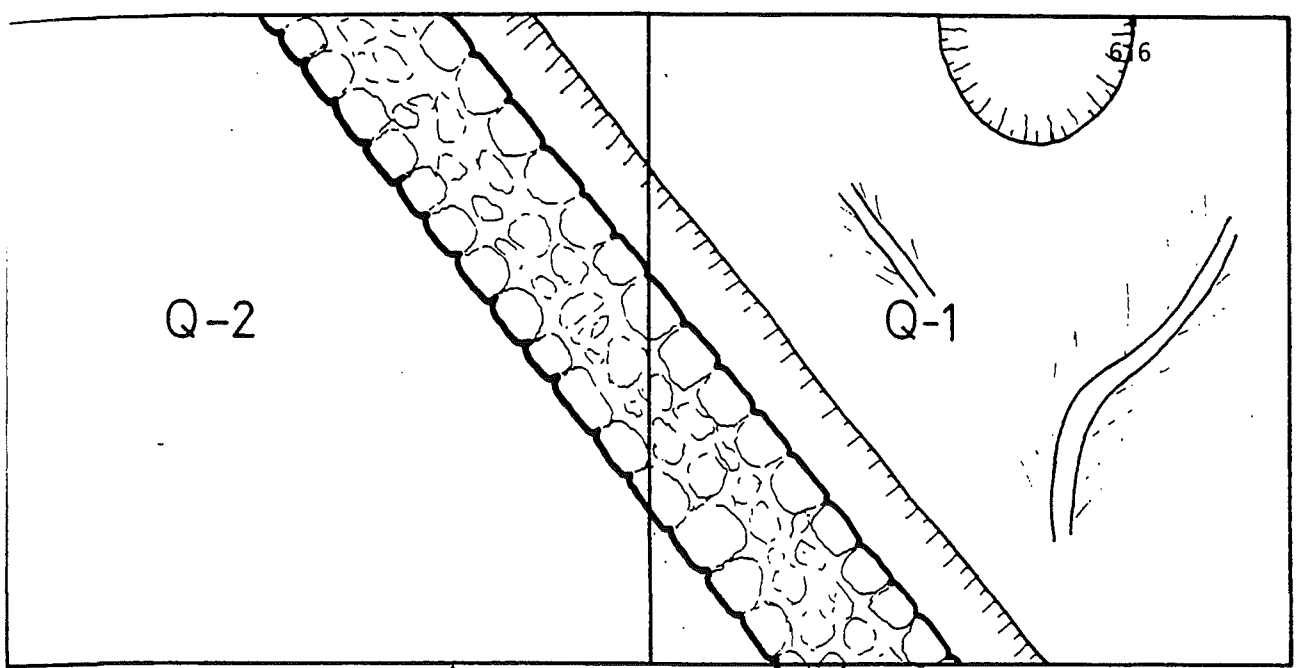
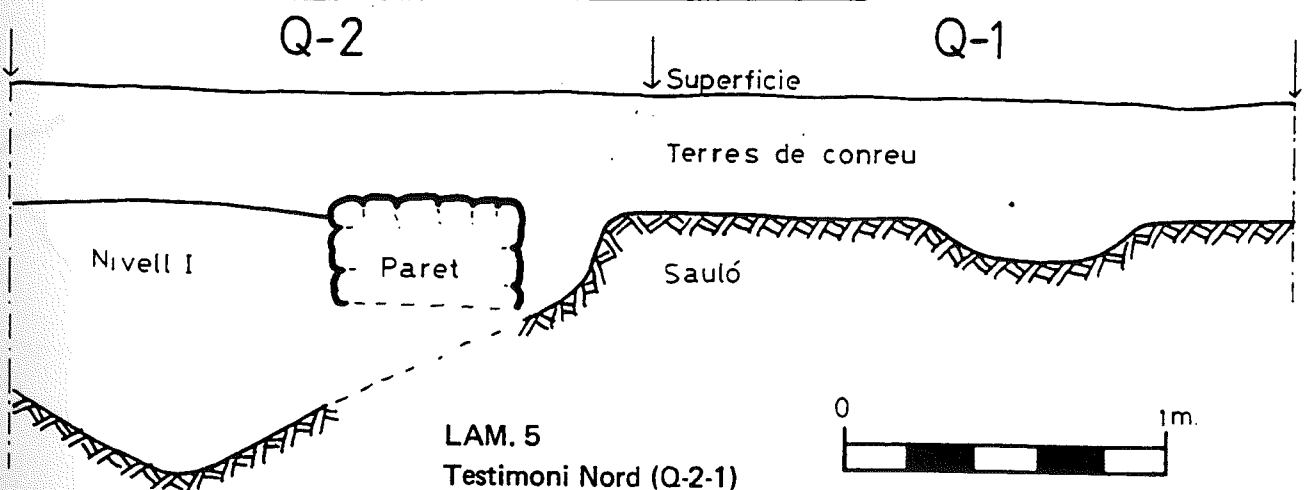

Fig. 36.1. Can Majoral (CLARIANA 1981).



LAM. 5
Testimoni Nord (Q-2-1)

Fig. 36.2. Can Majoral (CLARIANA 1981).

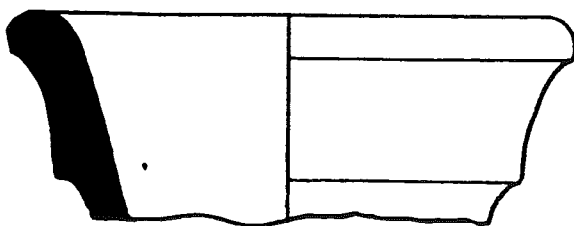

Fig. 36.3. Can Majoral (CLARIANA 1981).

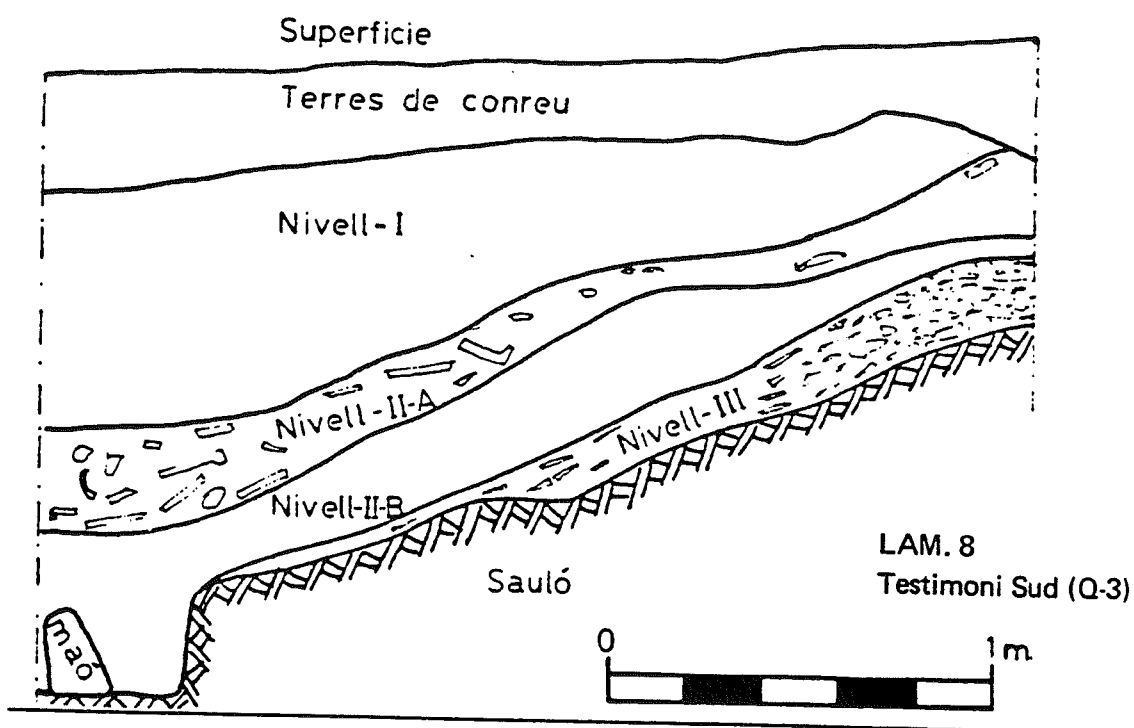

Fig. 36.4. Can Majoral (CLARIANA 1981).

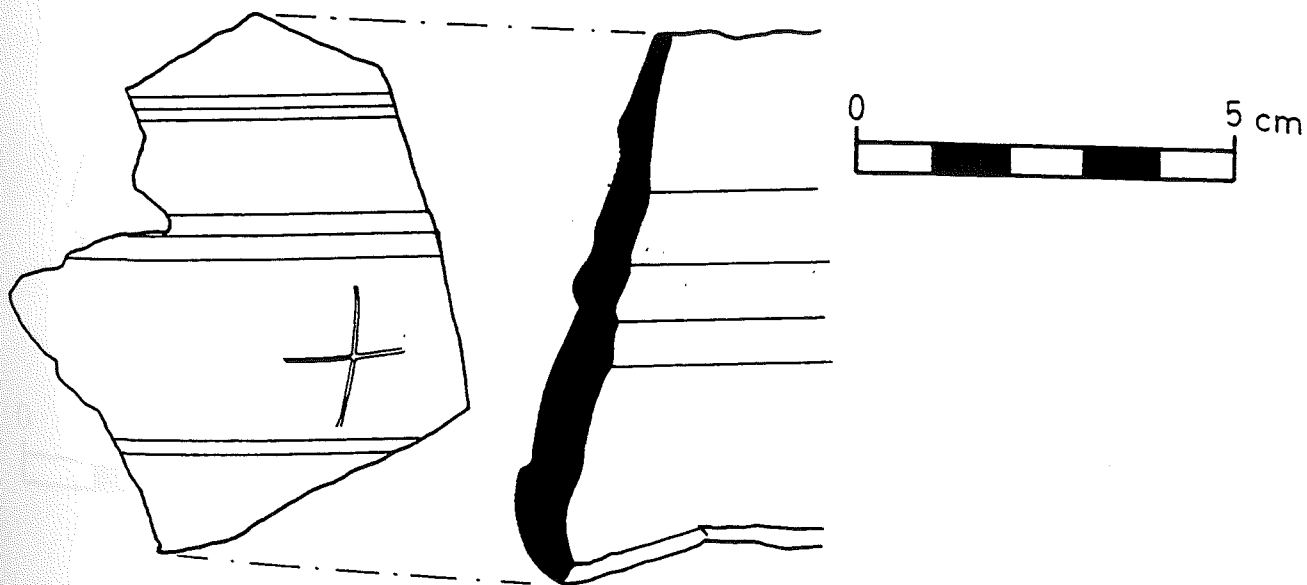
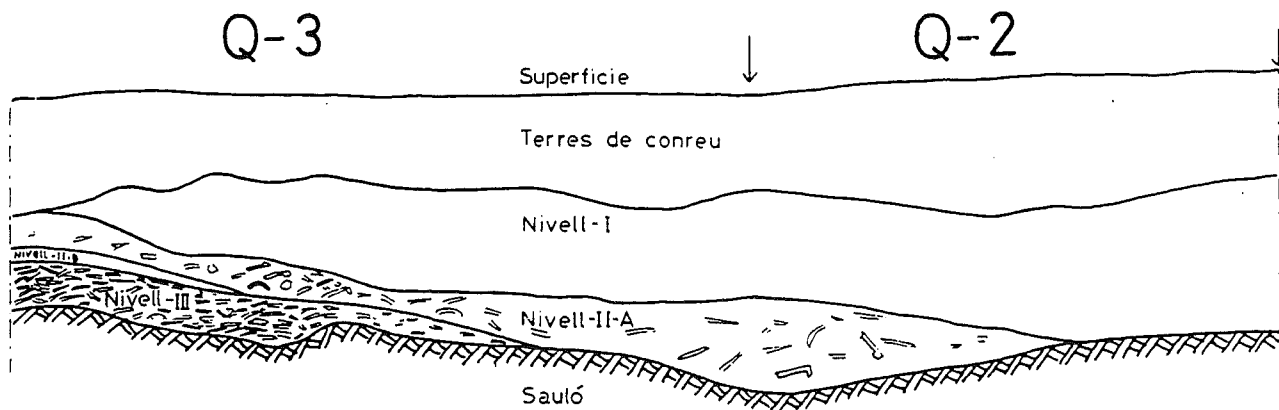

Fig. 36.5. Can Majoral (CLARIANA 1981).



LAM. 7

Testimoni Oest (Q-3-2)

Fig. 36.6. Can Majoral (CLARIANA 1981).

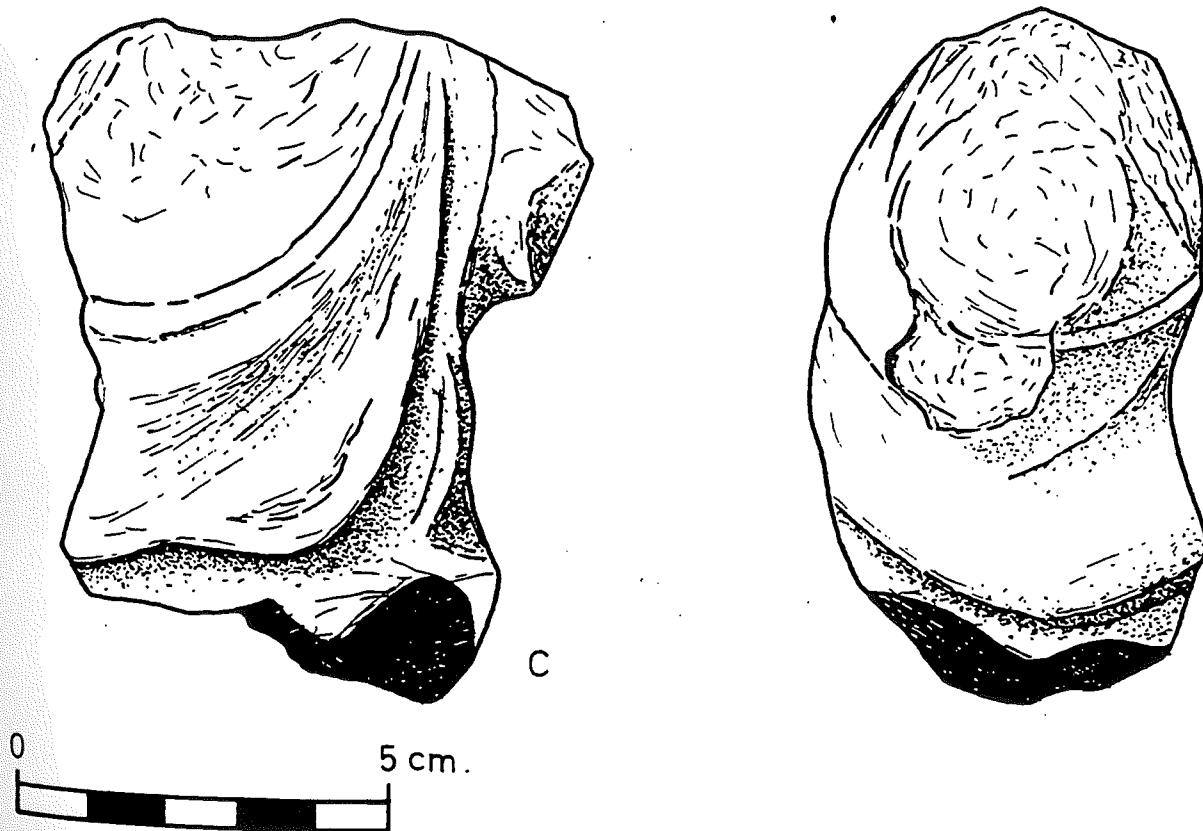

Fig. 36.7. Can Majoral (CLARIANA 1981).

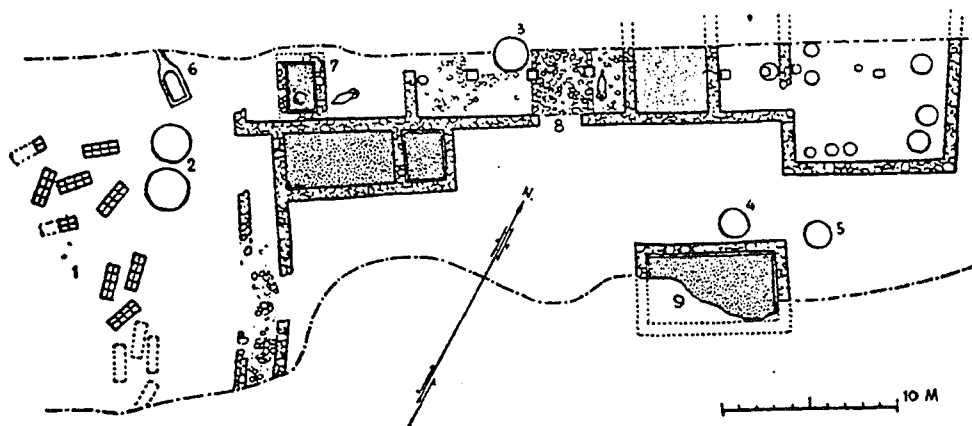

Fig. 37.1. Can Rafart (S.A.M.M. 1977b)

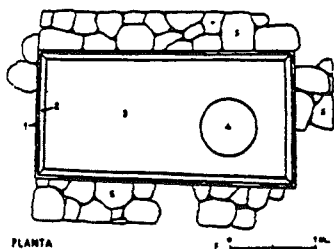
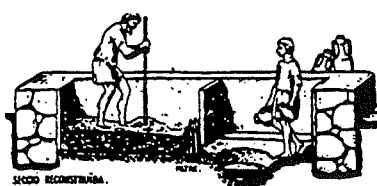
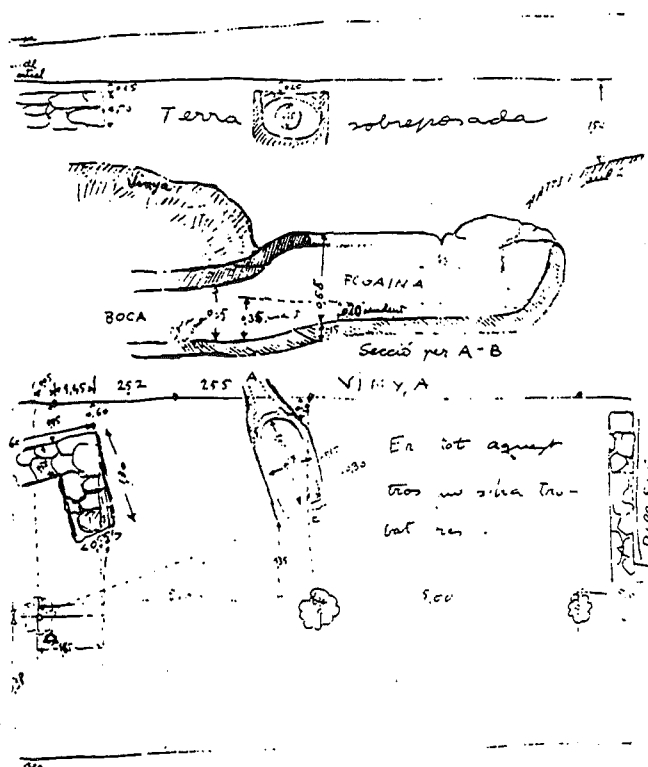

Fig. 37.2. Can Rafart (PREVGSTI 1981a)



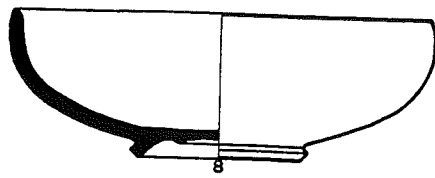

Fig. 37.3. Can Rafart
(PREVOSTI 1981a)

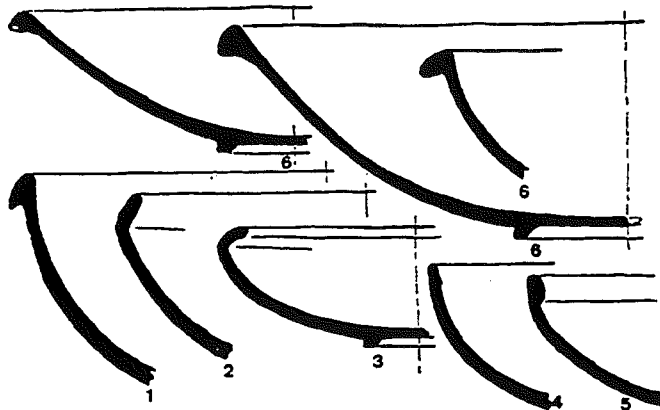

Fig. 37.4. Can Rafart (PREVOSTI 1981a)

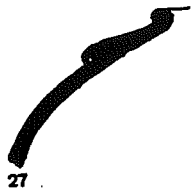

Fig. 37.5. Can Rafart (PREVOSTI 1981a)

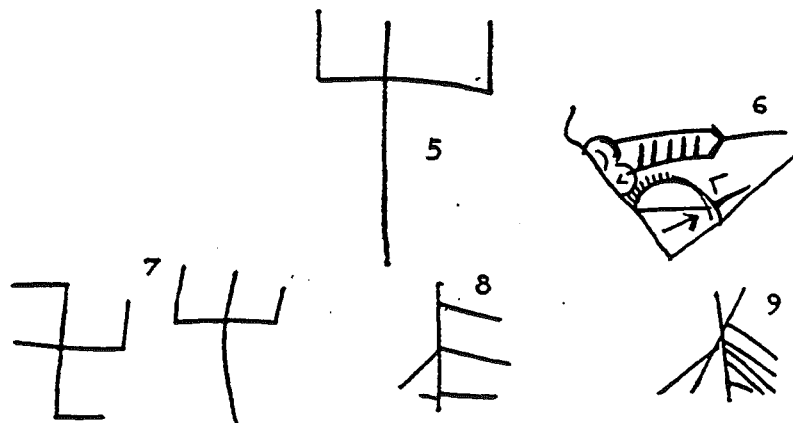

Fig. 37.6. Can Rafart (RIBAS 1988)

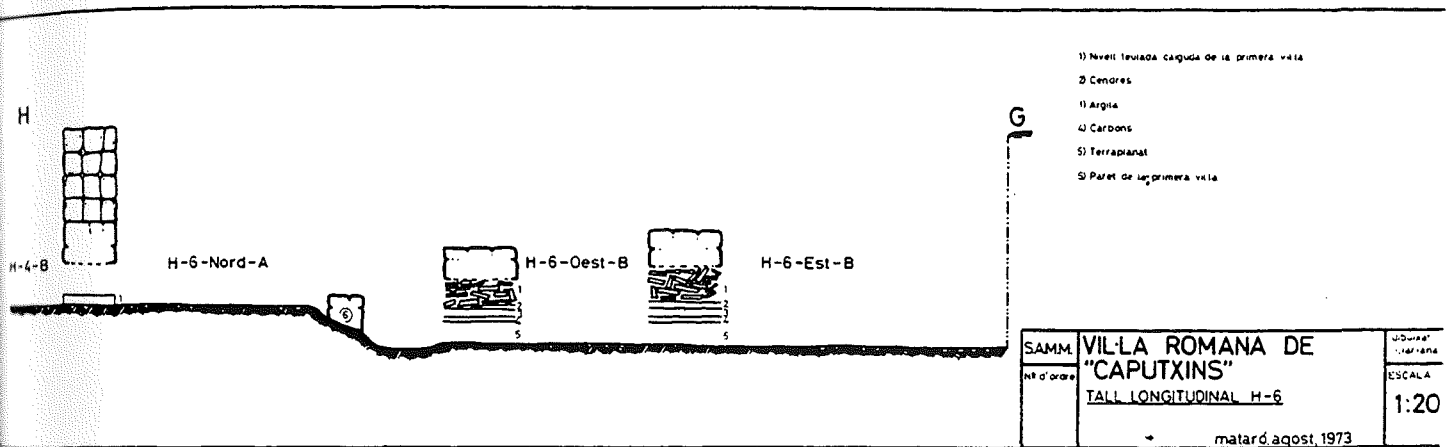
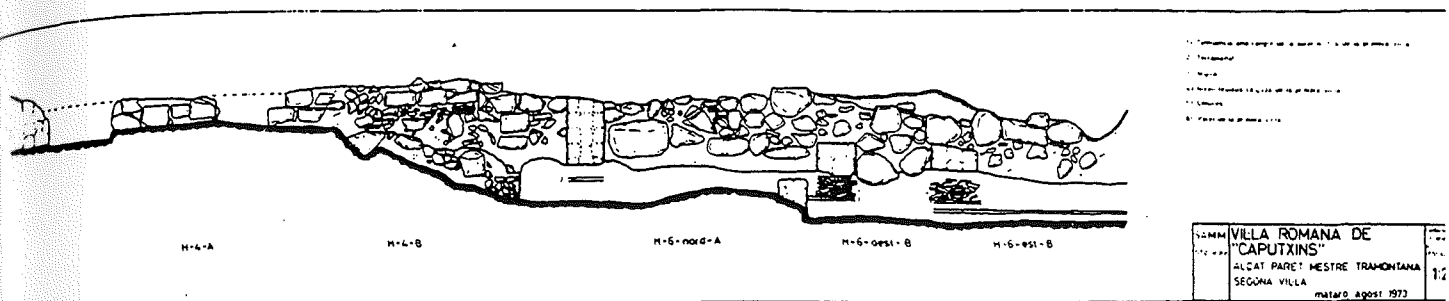

Fig. 38.2. Villa dels Caputxins (PREVOSTI 1981a)

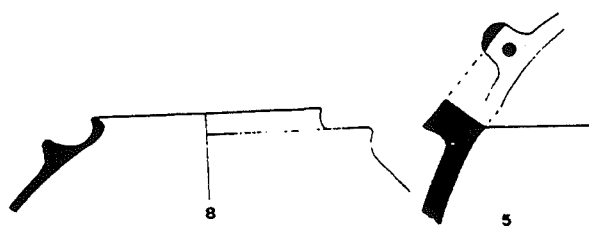

Fig. 38.3 i 38.4. Villa dels Caputxins (PREVOSTI 1981a)

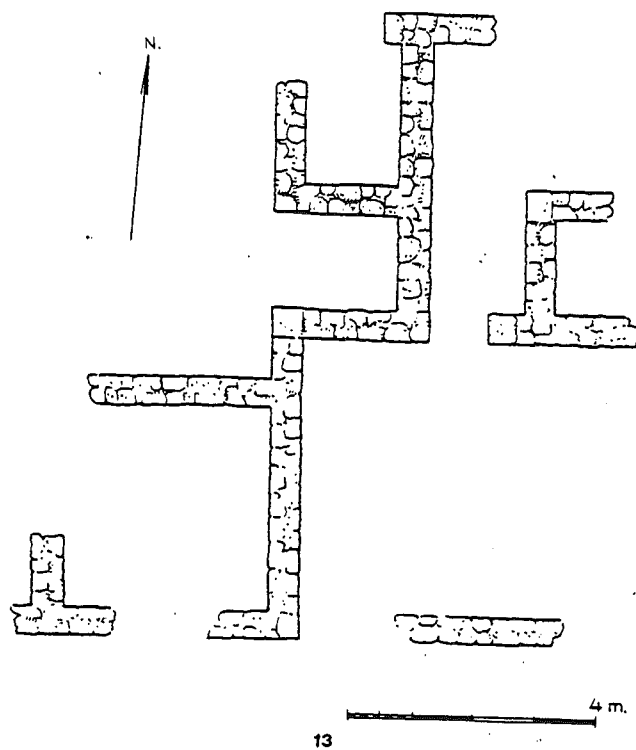

Fig. 39.1. Jardineria Bada (PREVOSTI 1981a).

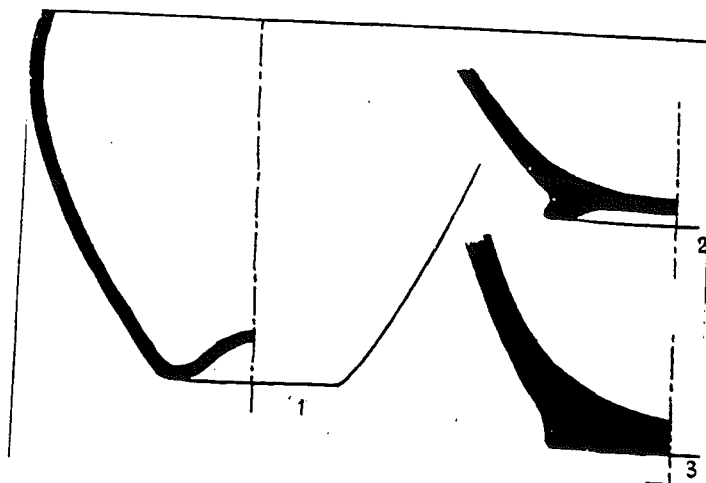

Fig. 39.2. Jardineria Bada (PREVOSTI 1981a).

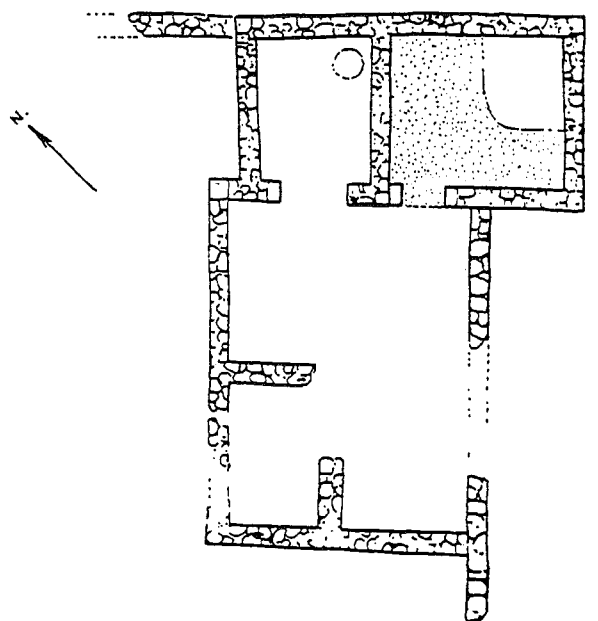
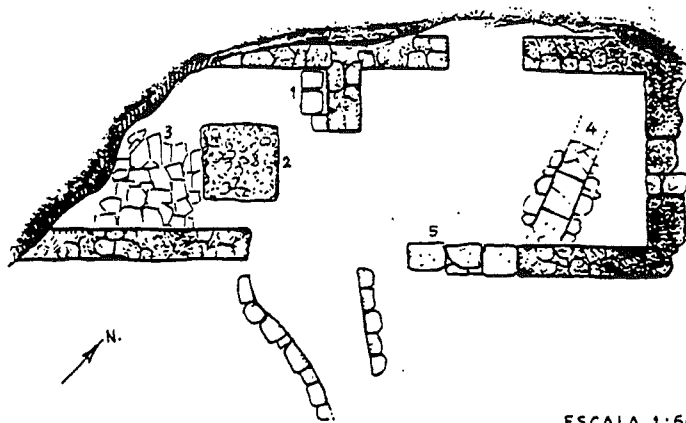

Fig. 40. Prop del Torrent de la Pólvora (PREVOSTI 1981a)



ESCALA 1:50

Fig. 41.1. Vivers Municipals (PREVOSTI 1981a).

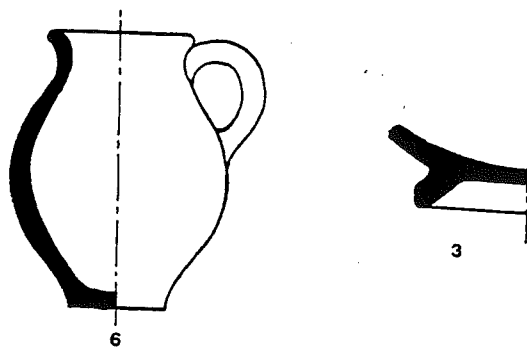

Fig. 41.2. Vivers Municipals (PREVOSTI 1981a).

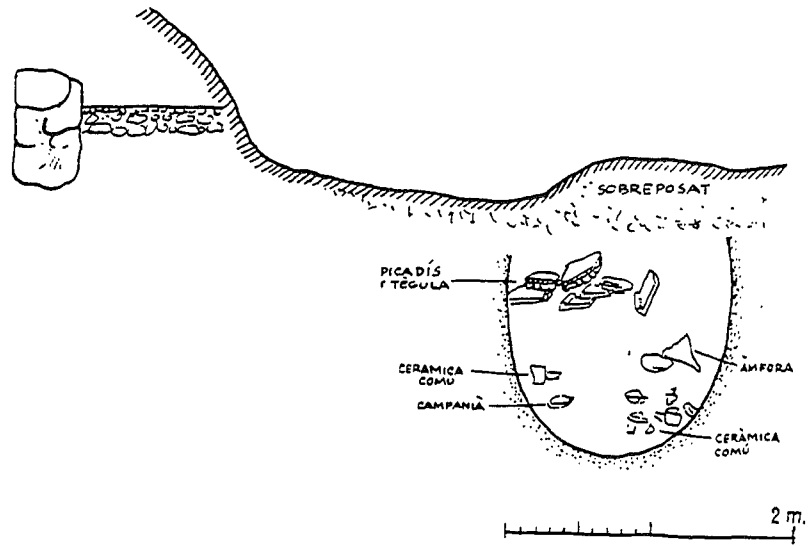

Fig. 42. Fabrica Massana (PREVOSTI 1981a).

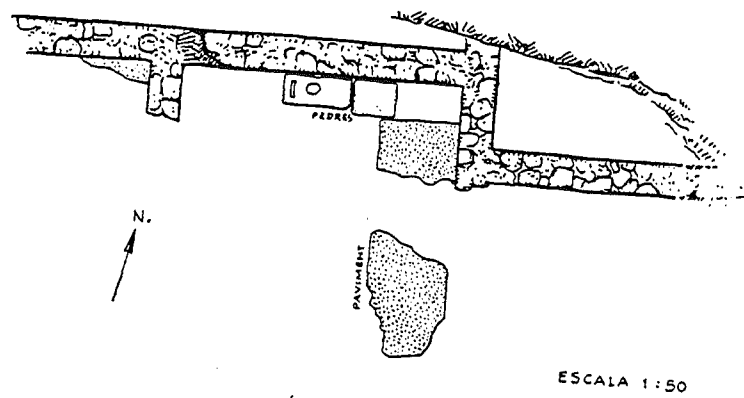

Fig. 43. Camí dels Contrabandistes (PREVOSTI 1981a).

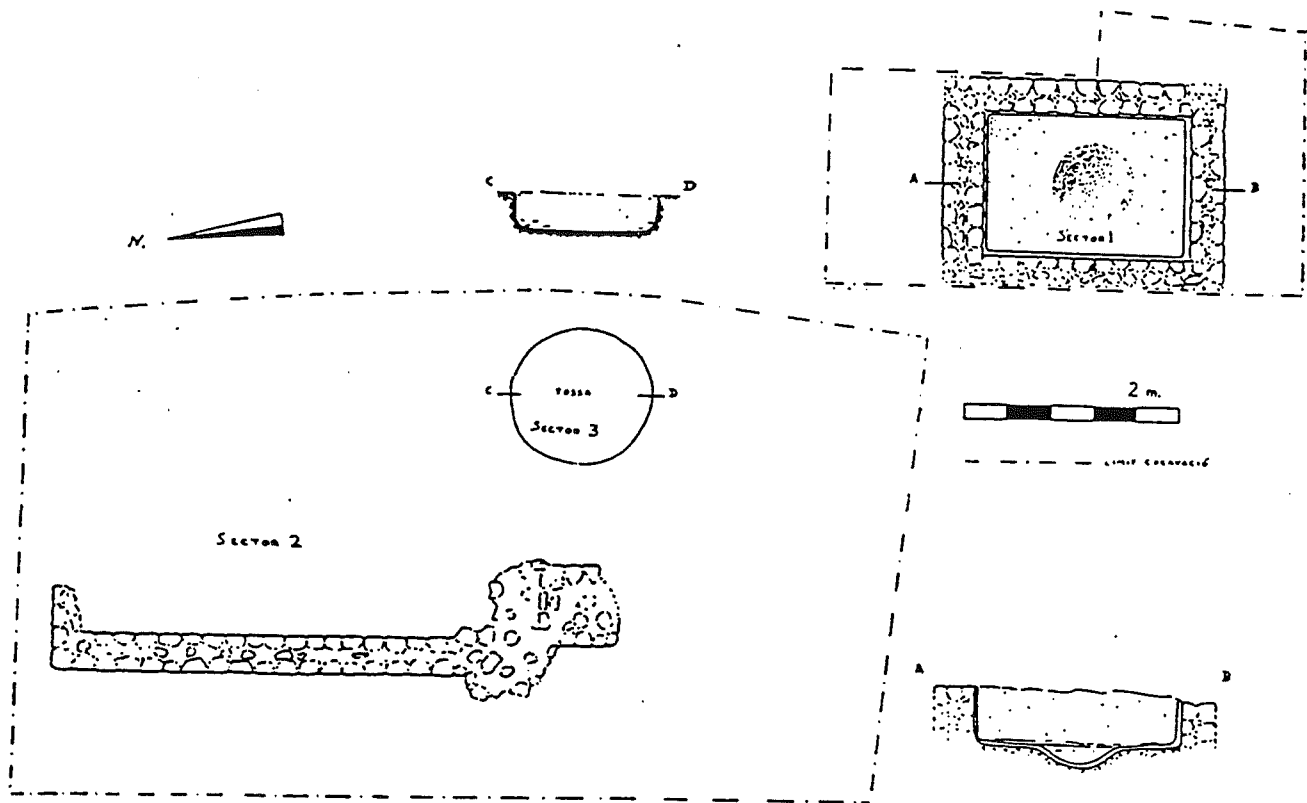

Fig. 44. Roca Fonda (PREVOSTI-CLARIANA 1990).

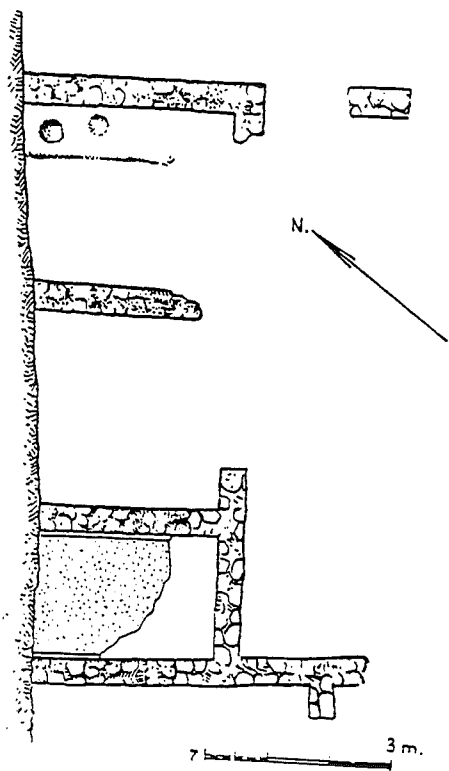

Fig. 45.1 Figuera Major (PREVOSTI 1981a).

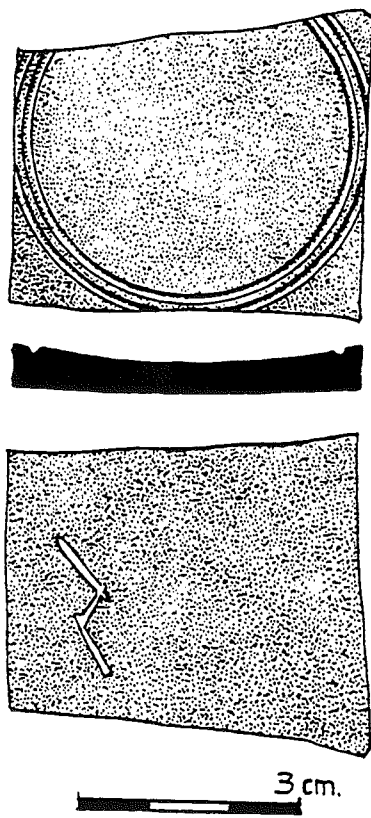

Fig. 45.2 Figuera Major (RIBAS 1982).

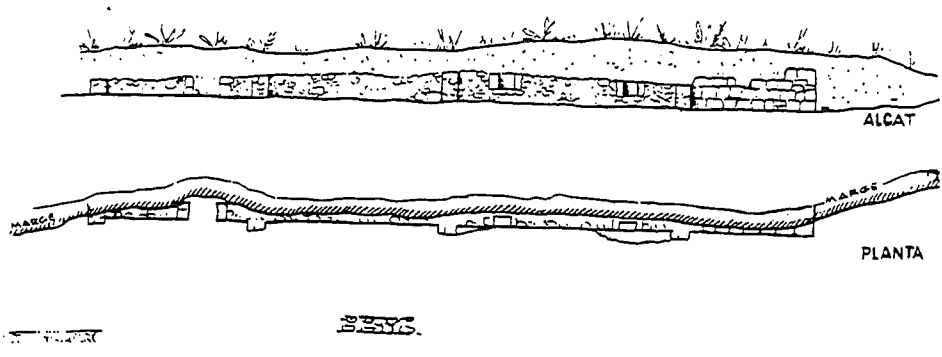

Fig. 46.1. Torrent de les Piques (PREVOSTI 1981a)

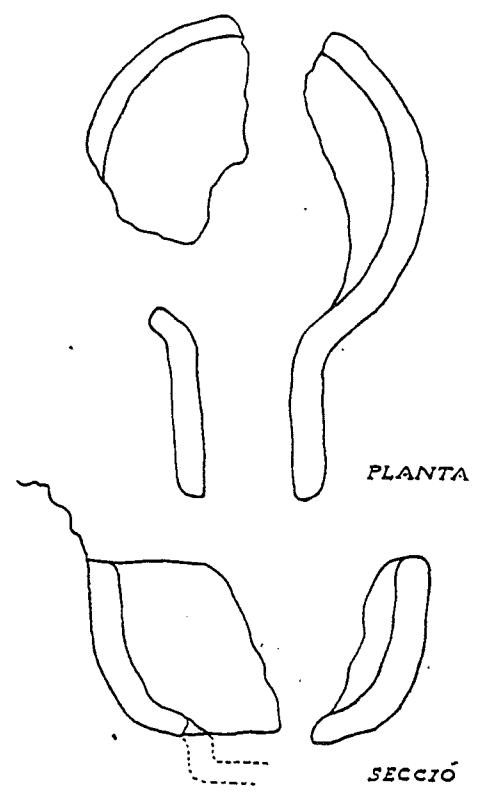

Fig. 46.2. Torrent de les Piques (PREVOSTI 1981a)

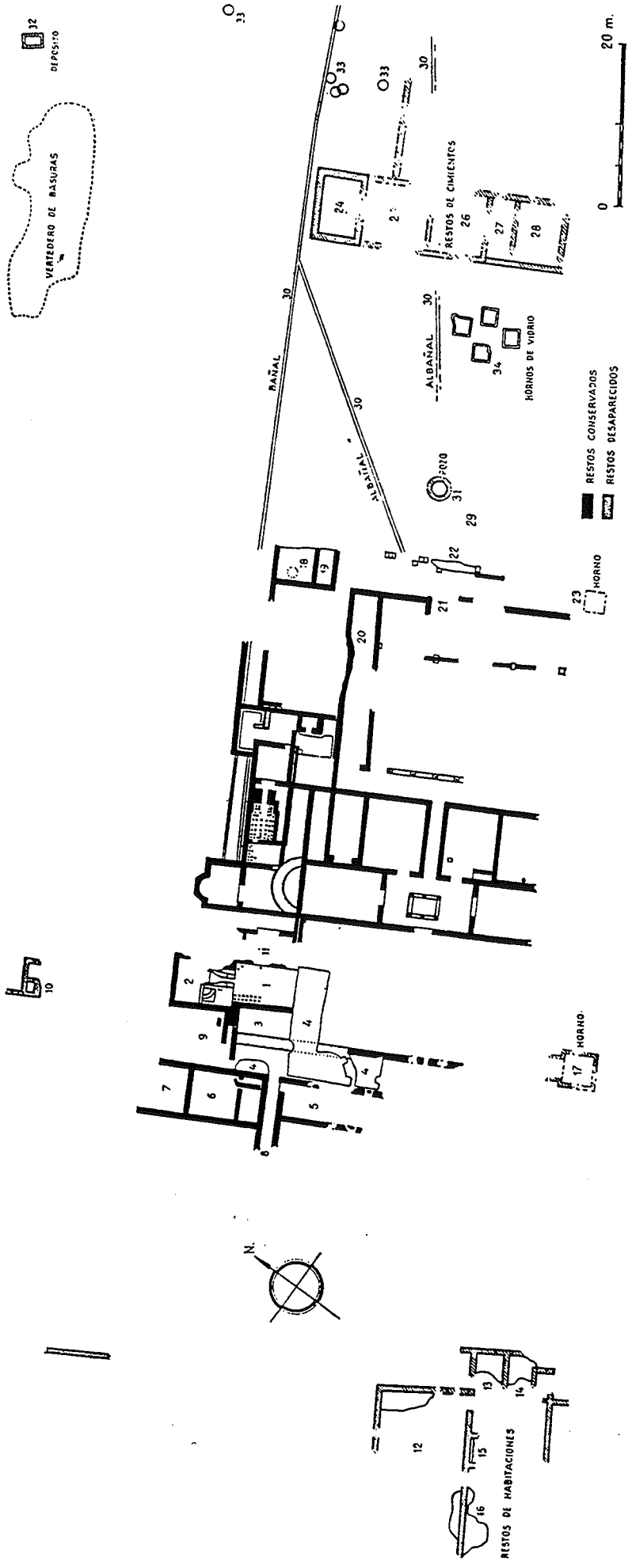

Fig. 47.1. Torre Llauder (S.A.M.M. 1977b).

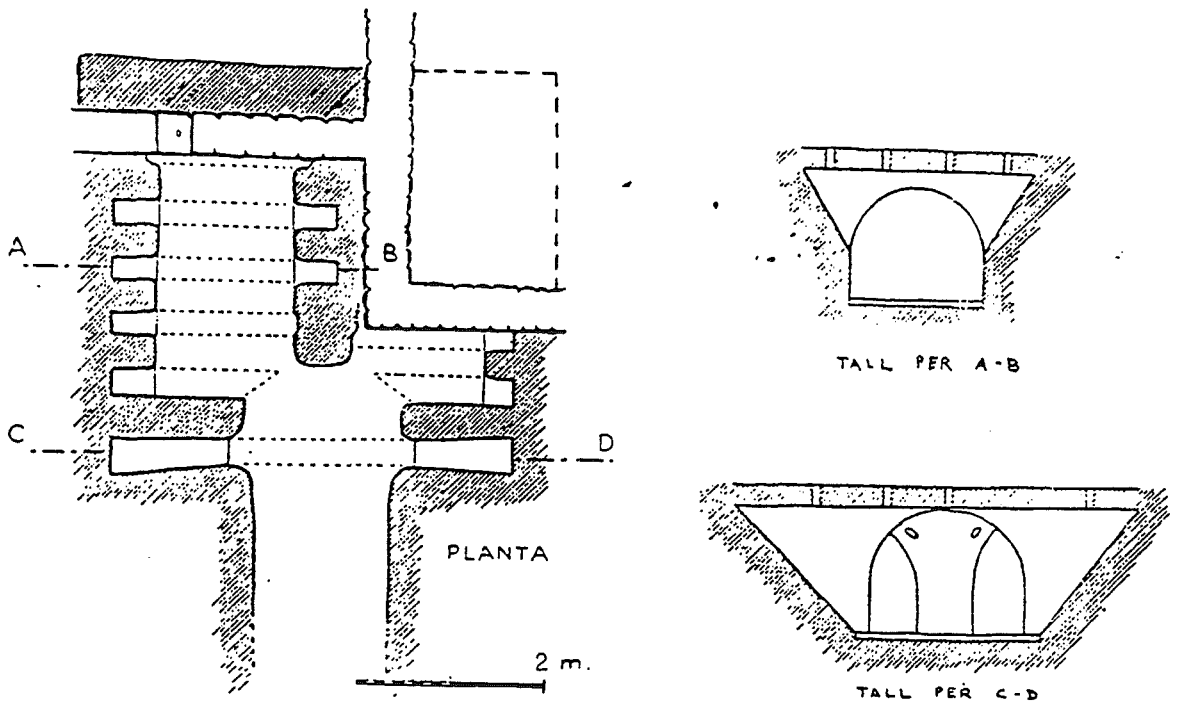

Fig. 47.2. Torre Llauder (PREVOSTI-CLARIANA 1987)

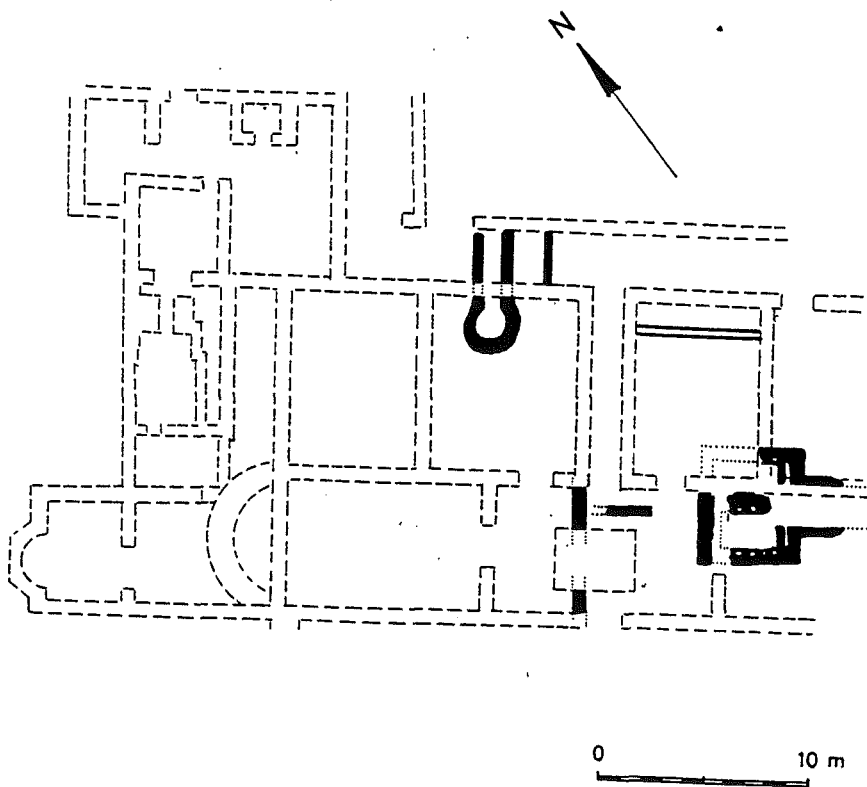

Fig. 47.3. Torre Llauder (PREVOSTI-CLARIANA 1987)

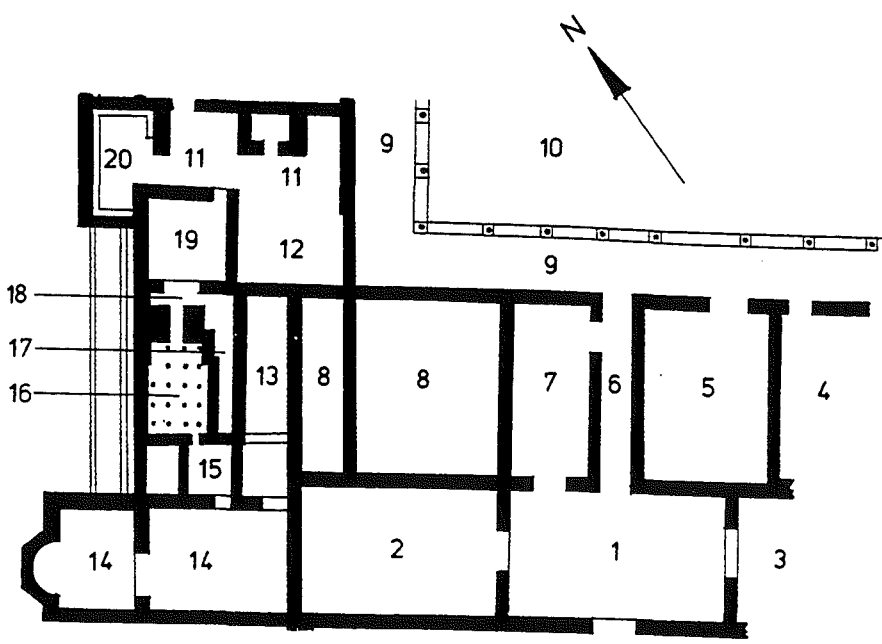

Fig. 47.4. Torre Llauder (PREVOSTI-CLARIANA 1937)

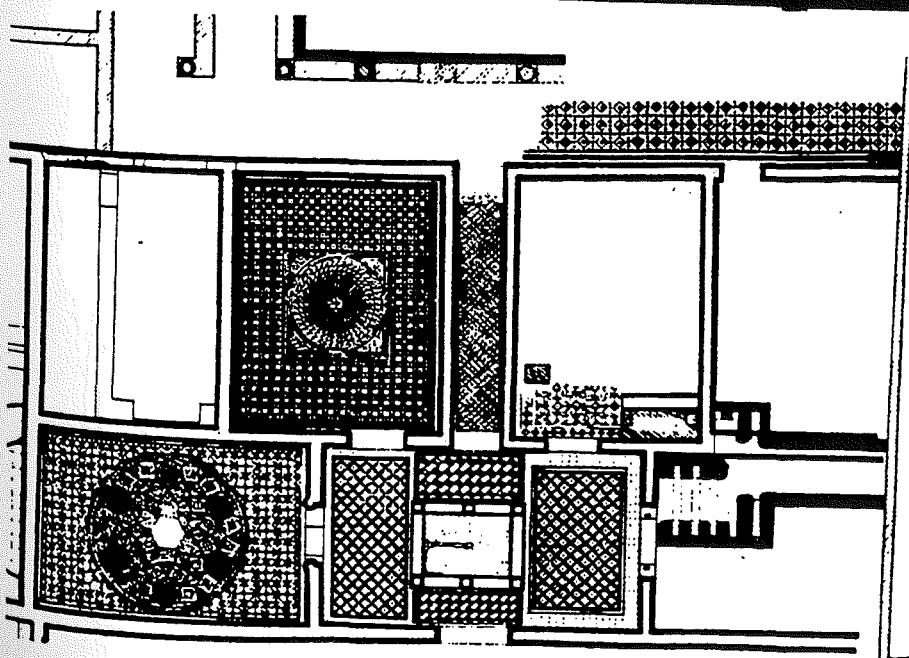
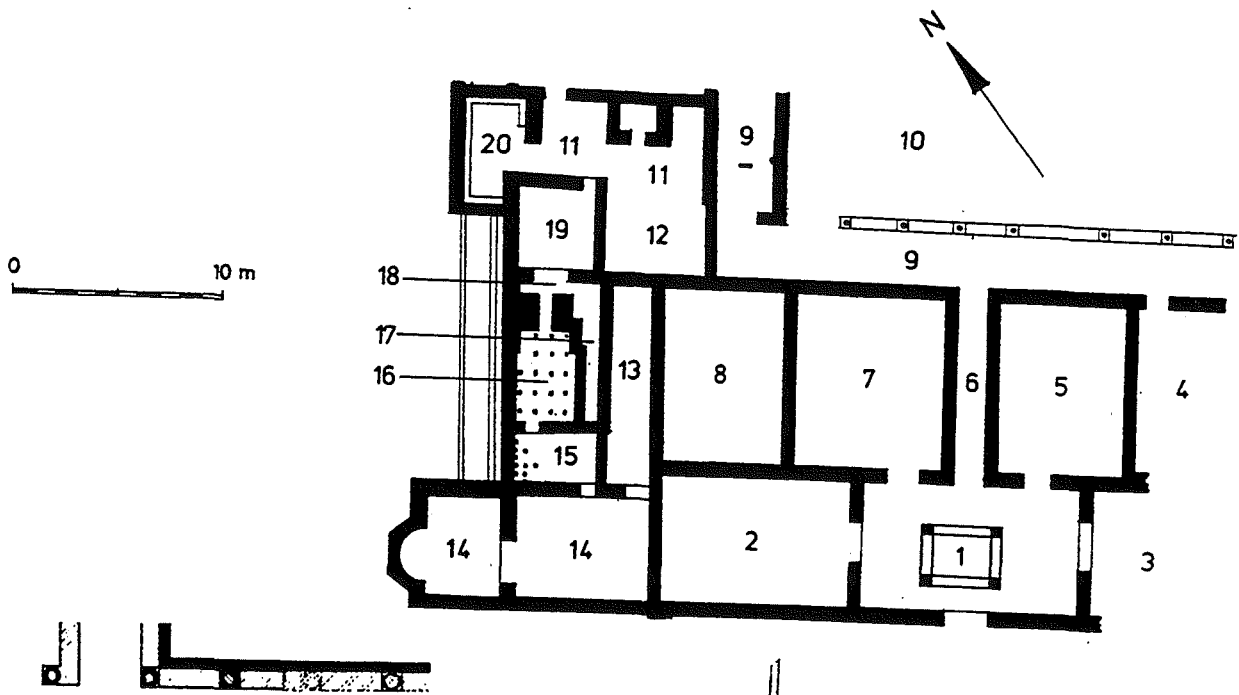

Fig. 47.5. Torre Llauder (PREVOSTI-CLARIANA 1937)

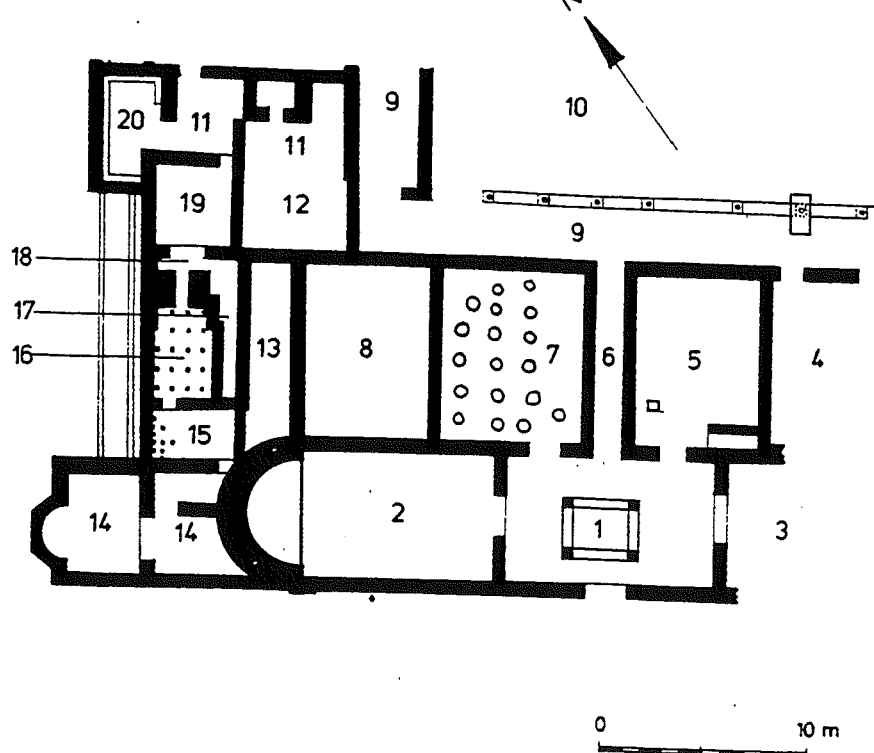

Fig. 47.6. Torre Llauder (PREVOSTI-CLARIANA 1987)

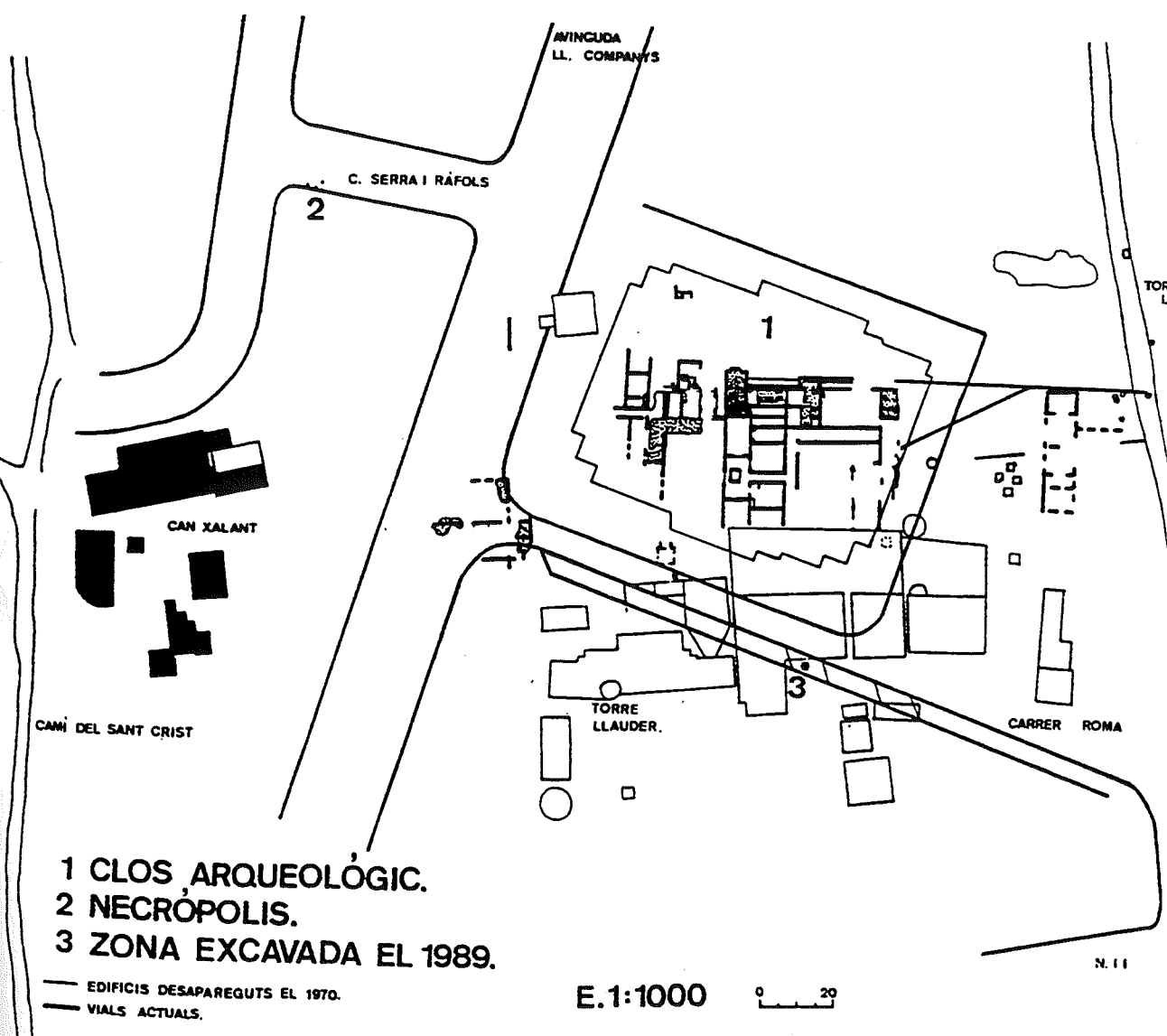

Fig. 47.7. Torre Llauder (CERDA-PEREZ 1991)

VILLA ROMANA DE "TORRE (MATARÓ, EL MARESM

- SECTOR DEL "MOSAIC DE LA PALMEI
- PLANTA GENERAL DE LES RESTES R A NIVELL DE PAVIMENTS.

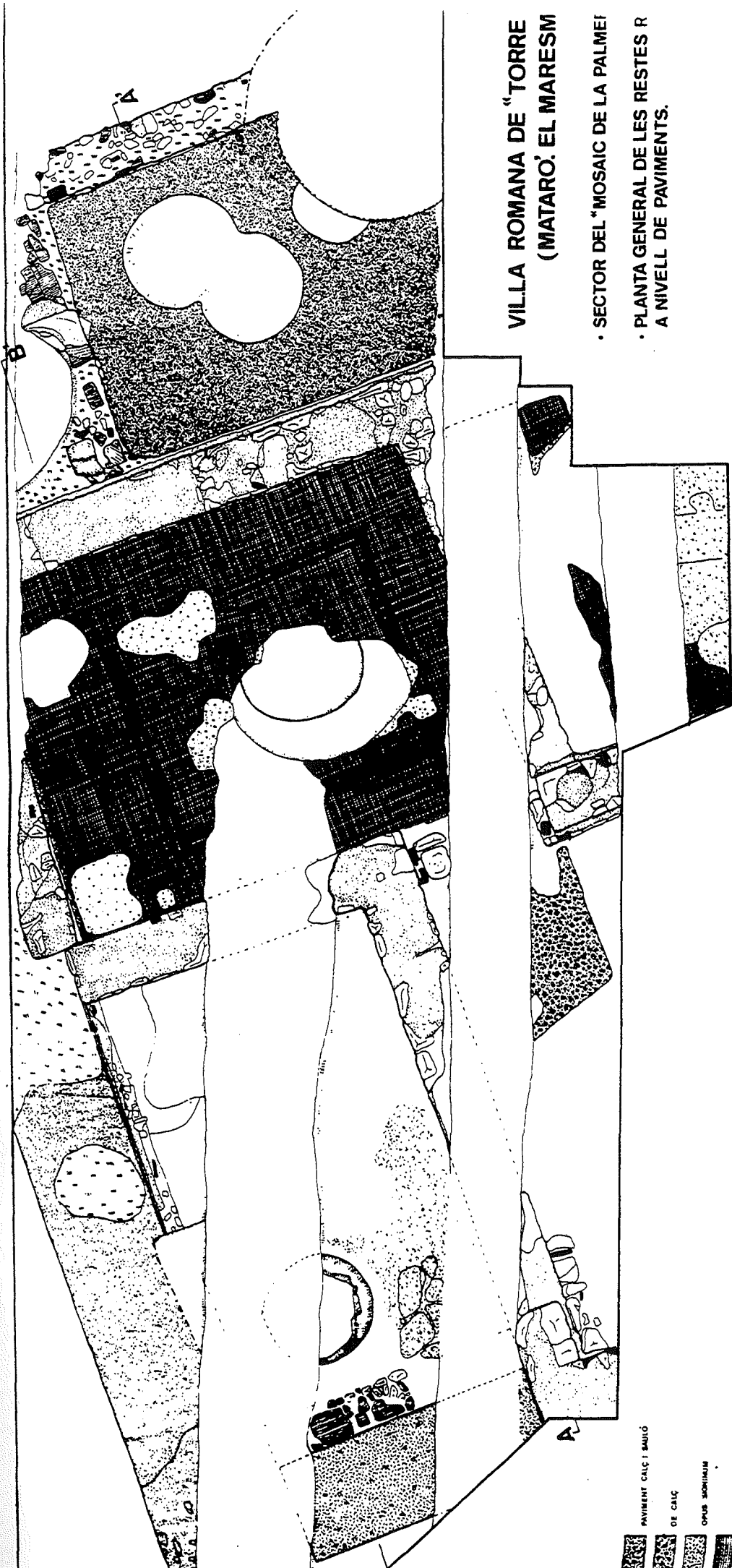

Fig. 47.8. Torre Llauder (CERDA-FEREZ 1991)

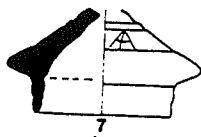

Fig. 47.9. Torre Llauder
(PREVOSTI 1981a)

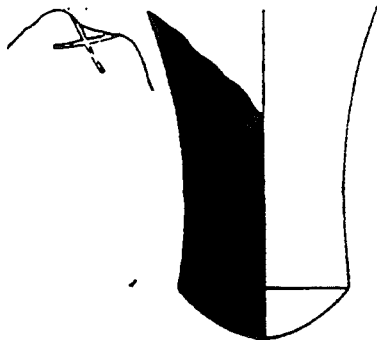
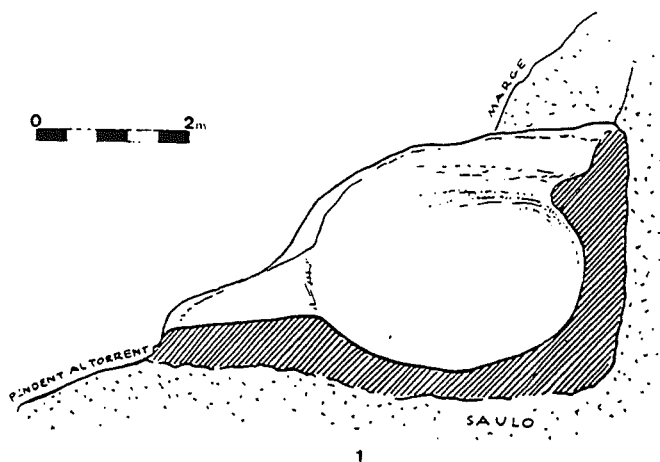

Fig. 47.10. Torre Llauder
(PREVOSTI-CLARIANA 1987)



0 2m

PENDENT AL TORRENT

MARÇE

SAULO

1

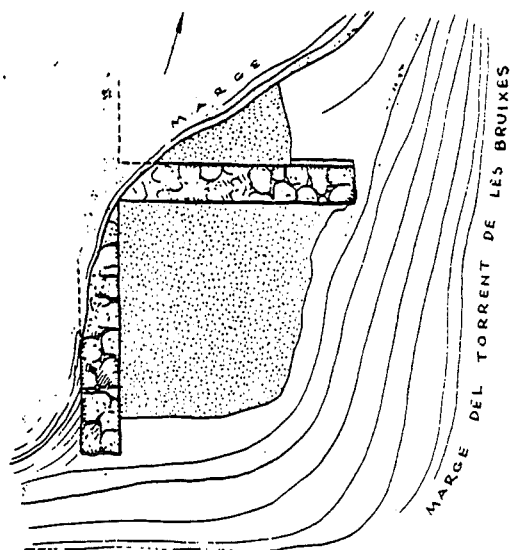

CARRETERA DE FRANÇA

0 2.5m

MARÇE DEL TORRENT DE LES BRUIXES

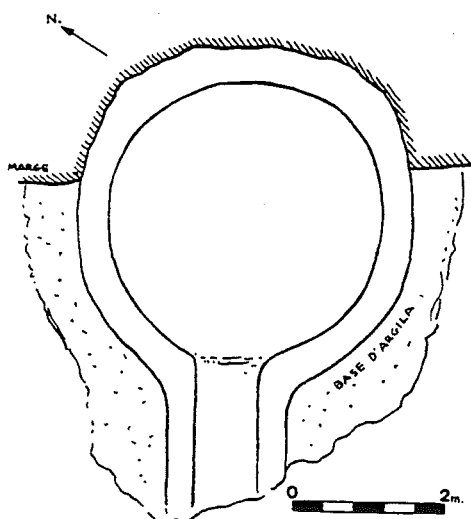

N.

MARÇE

BASE D'ÀGUILA

0 2m

Fig. 48.1. Vil.la del Morrell
(PREVOSTI 1981a).

Fig. 48.2. Vil.la del Morrell
(PREVOSTI 1981a).

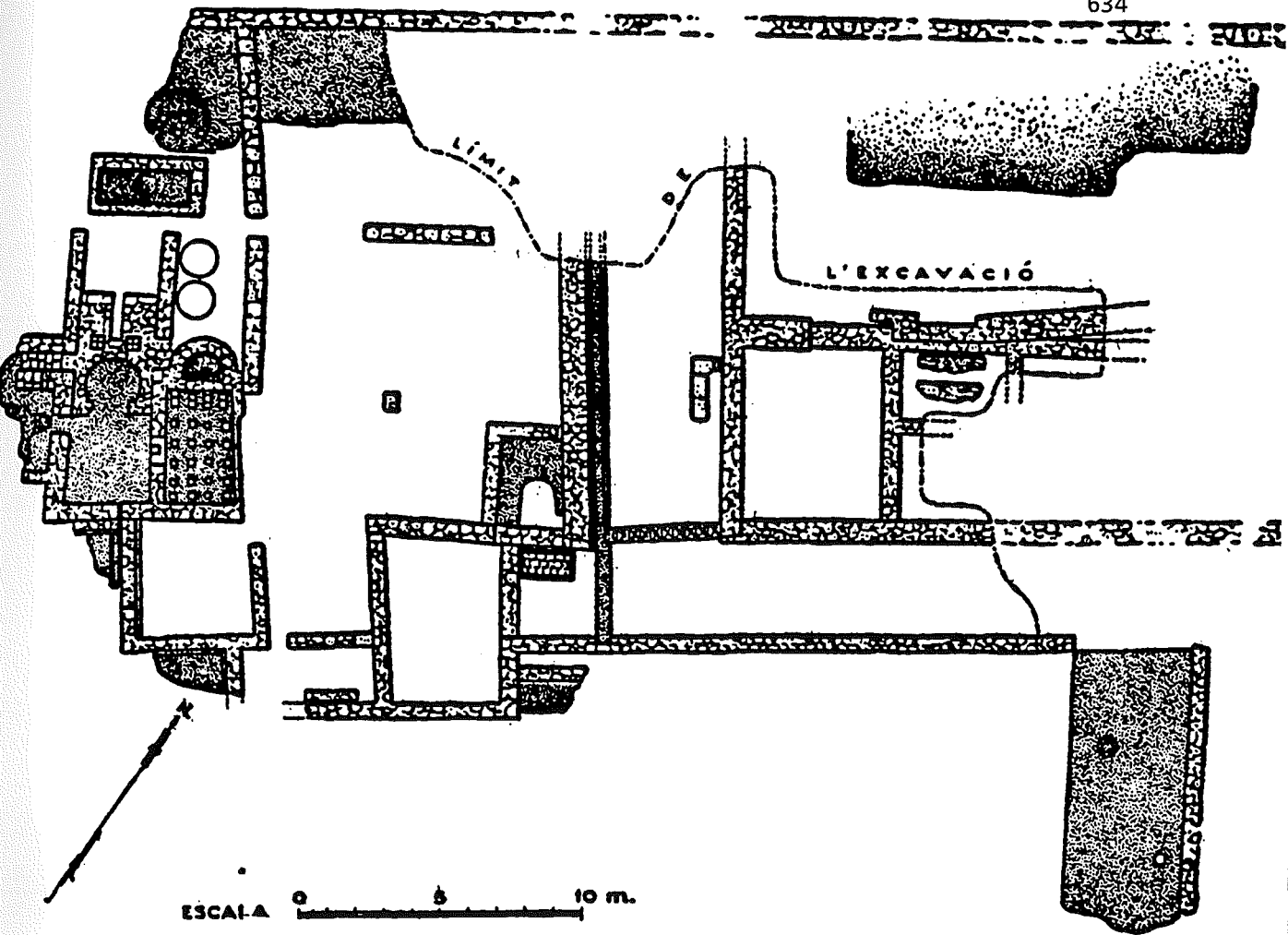

Fig. 49.1. Can Sans (PREVOSTI 1981a)

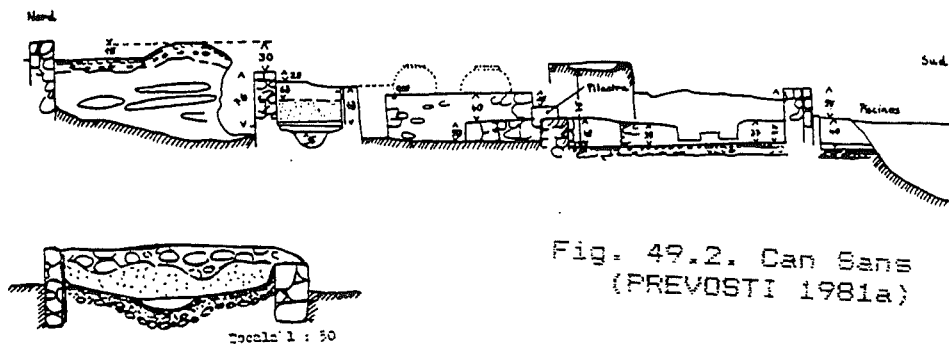

Fig. 49.2. Can Sans (PREVOSTI 1981a)

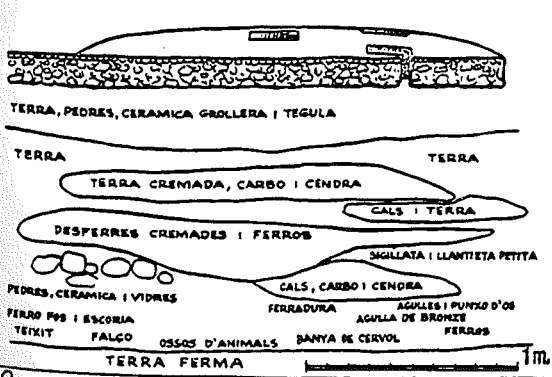

Fig. 49.3. Can Sans (PREVOSTI 1981a)

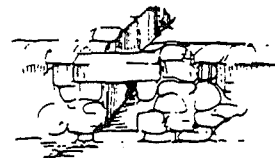

Fig. 49.4. Can Sans (PREVOSTI 1981a)

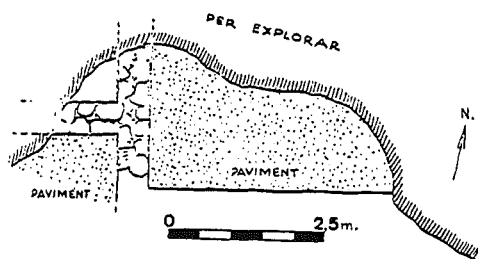

Fig. 50.1. Sot del Camp (PREVOSTI 1981a).

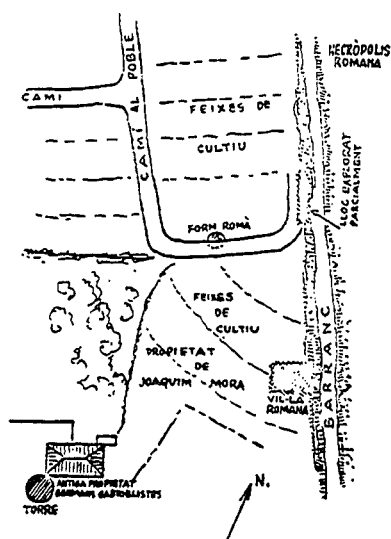

Fig. 50.2. Sot del Camp (PREVOSTI 1981a).

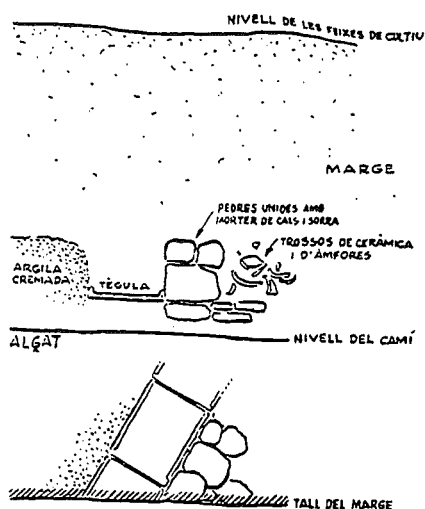

Fig. 50.3. Sot del Camp (PREVOSTI 1981a).



Fig. 50.4. Sot del Camp (PREVOSTI 1981a).

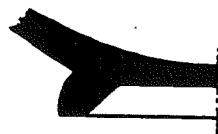

Fig. 50.5. Sot del Camp (PREVOSTI 1981a).



Fig. 50.6. Sot del Camp (PREVOSTI 1981a).

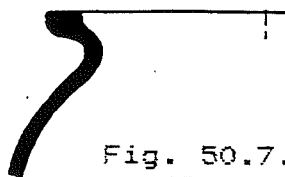

Fig. 50.7. Sot del Camp (PREVOSTI 1981a).

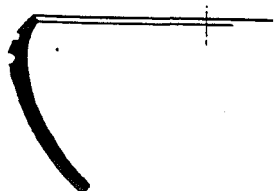

Fig. 50.8. Sot del Camp (PREVOSTI 1981a).



Fig. 50.9. Sot del Camp (PREVOSTI 1981a).

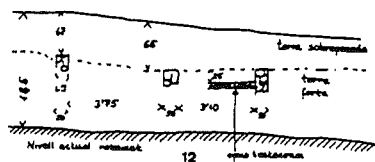

Fig. 51. Can Mora de Dalt
(PREVOSTI 1981a)

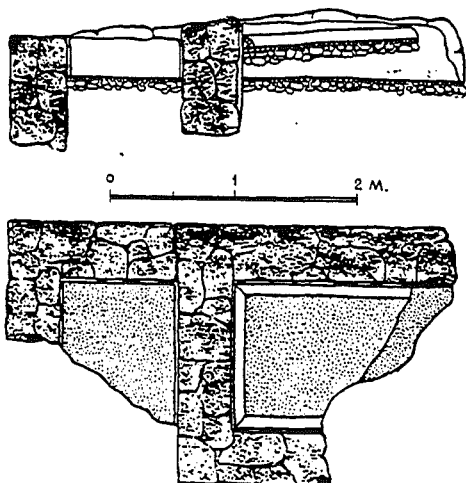

Fig. 52.1. Can Tarradas
(PREVOSTI 1981a)

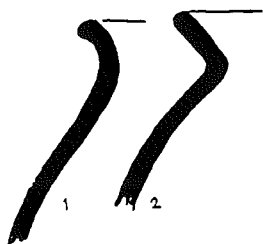
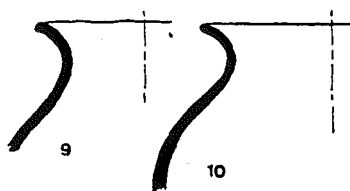
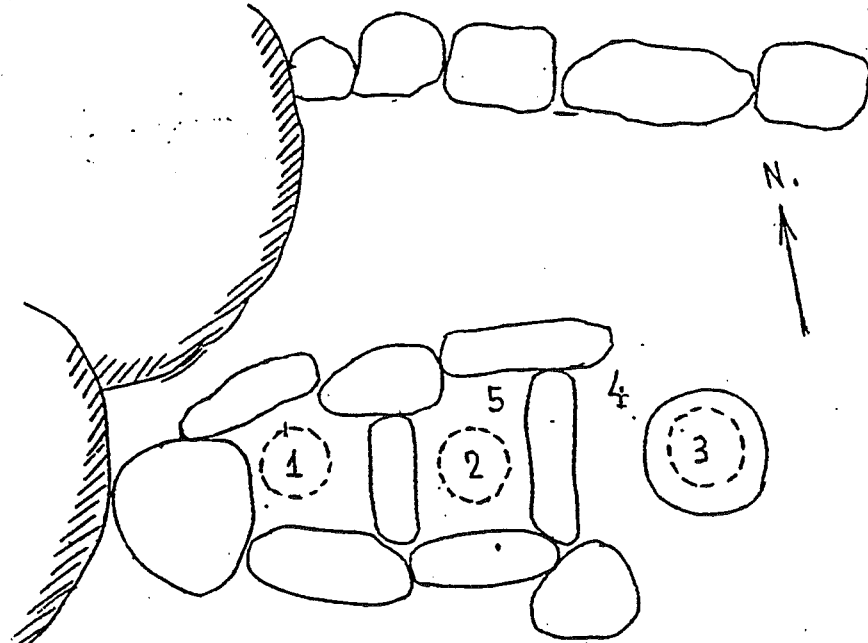

Fig. 52.2. Can Tarradas
(PREVOSTI 1981a)





Planol dels enterraments ibèrics
de Turó de Castellà.

- 1, 2 i 3 - urnes cineràries.
- 4 - situació dels ferros i dos
ullals de senglar.
- 5 - situació dels ploms.

ESCALA 1 : 20

Fig. 53. Turó del Castellar (RIBAS 1949)

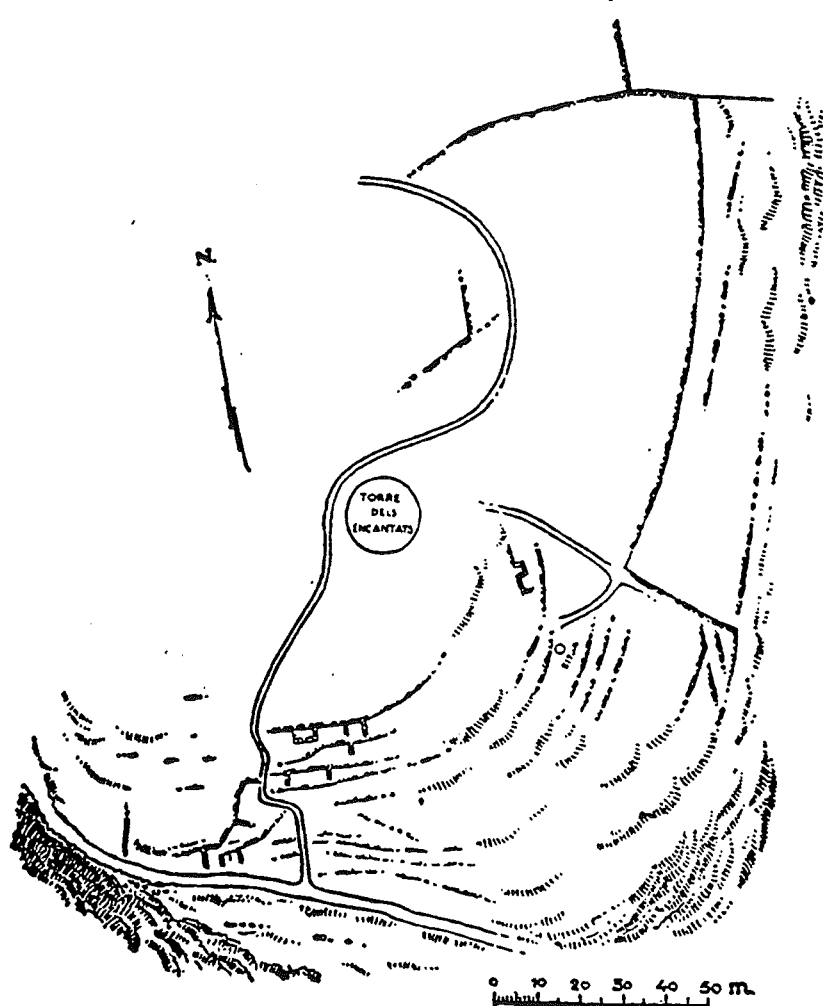

Fig. 54 Torre dels Encantats
(SERRA RAFOLS ET ALII 1945)