

M
M
M



**DISEÑO DE INSTRUMENTAL CIENTIFICO
DESTINADO A LA CARACTERIZACION Y
ESTRUCTURA DE NUCLEO-PROTEINAS Y
POLIMEROS EN GENERAL.**

Tesis Doctoral JOAQUIN LLOVERAS MACIA

UNIVERSITAT POLITÈCNICA DE CATALUNYA
Biblioteca



1400069100

ESCUELA TÉCNICA SUPERIOR DE INGENIEROS INDUSTRIALES - BARCELONA





UNIVERSITAT POLITÈCNICA
DE CATALUNYA
BARCELONATECH

Diseño de instrumental científico destinado a la caracterización y estructura de nucleo-proteínas y polímeros en general

Joaquín Lloveras Maciá

ADVERTIMENT La consulta d'aquesta tesi queda condicionada a l'acceptació de les següents condicions d'ús: La difusió d'aquesta tesi per mitjà del repositori institucional UPCCommons (<http://upcommons.upc.edu/tesis>) i el repositori cooperatiu TDX (<http://www.tdx.cat/>) ha estat autoritzada pels titulars dels drets de propietat intel·lectual **únicament per a usos privats** emmarcats en activitats d'investigació i docència. No s'autoritza la seva reproducció amb finalitats de lucre ni la seva difusió i posada a disposició des d'un lloc aliè al servei UPCCommons o TDX. No s'autoritza la presentació del seu contingut en una finestra o marc aliè a UPCCommons (*framing*). Aquesta reserva de drets afecta tant al resum de presentació de la tesi com als seus continguts. En la utilització o cita de parts de la tesi és obligat indicar el nom de la persona autora.

ADVERTENCIA La consulta de esta tesis queda condicionada a la aceptación de las siguientes condiciones de uso: La difusión de esta tesis por medio del repositorio institucional UPCCommons (<http://upcommons.upc.edu/tesis>) y el repositorio cooperativo TDR (<http://www.tdx.cat/?locale-attribute=es>) ha sido autorizada por los titulares de los derechos de propiedad intelectual **únicamente para usos privados enmarcados** en actividades de investigación y docencia. No se autoriza su reproducción con finalidades de lucro ni su difusión y puesta a disposición desde un sitio ajeno al servicio UPCCommons. No se autoriza la presentación de su contenido en una ventana o marco ajeno a UPCCommons (*framing*). Esta reserva de derechos afecta tanto al resumen de presentación de la tesis como a sus contenidos. En la utilización o cita de partes de la tesis es obligado indicar el nombre de la persona autora.

WARNING On having consulted this thesis you're accepting the following use conditions: Spreading this thesis by the institutional repository UPCCommons (<http://upcommons.upc.edu/tesis>) and the cooperative repository TDX (<http://www.tdx.cat/?locale-attribute=en>) has been authorized by the titular of the intellectual property rights **only for private uses** placed in investigation and teaching activities. Reproduction with lucrative aims is not authorized neither its spreading nor availability from a site foreign to the UPCCommons service. Introducing its content in a window or frame foreign to the UPCCommons service is not authorized (*framing*). These rights affect to the presentation summary of the thesis as well as to its contents. In the using or citation of parts of the thesis it's obliged to indicate the name of the author.

PLANOS

Tesis Doctoral **JOAQUIN LLOVERAS MACIA**

ESCUELA TÉCNICA SUPERIOR DE INGENIEROS INDUSTRIALES - BARCELONA



LISTA DE PLANOS

Plano Nº 1	Pie del monocromador
Plano Nº 2	Módulo común de deslizamiento
Plano Nº 3	Soporte para la muestra
Plano Nº 4	Soporte para el tubo de hidrógeno
Plano Nº 5	Soporte para la placa fotográfica
Plano Nº 6	Soporte para el microscopio posicionador.



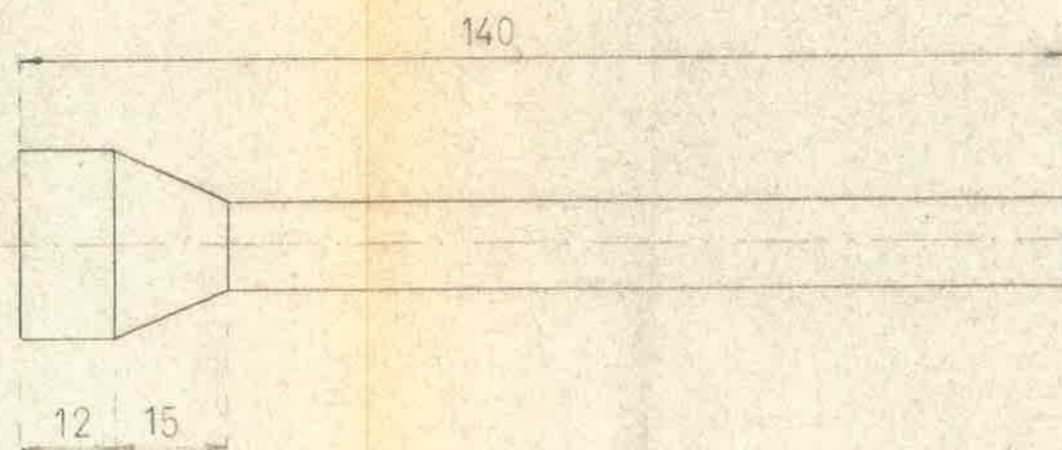
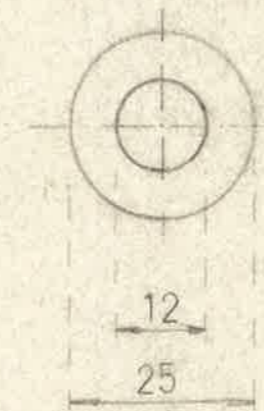
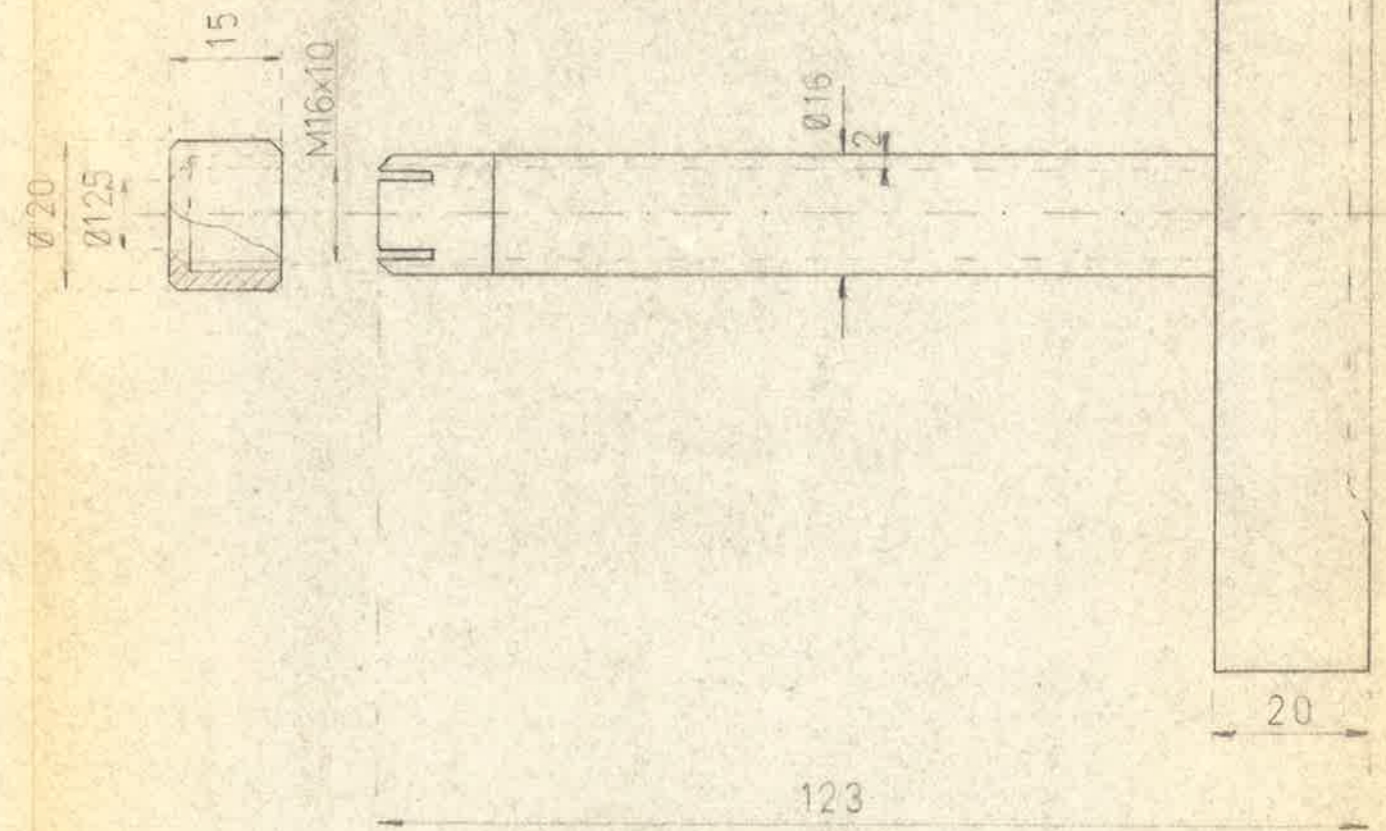
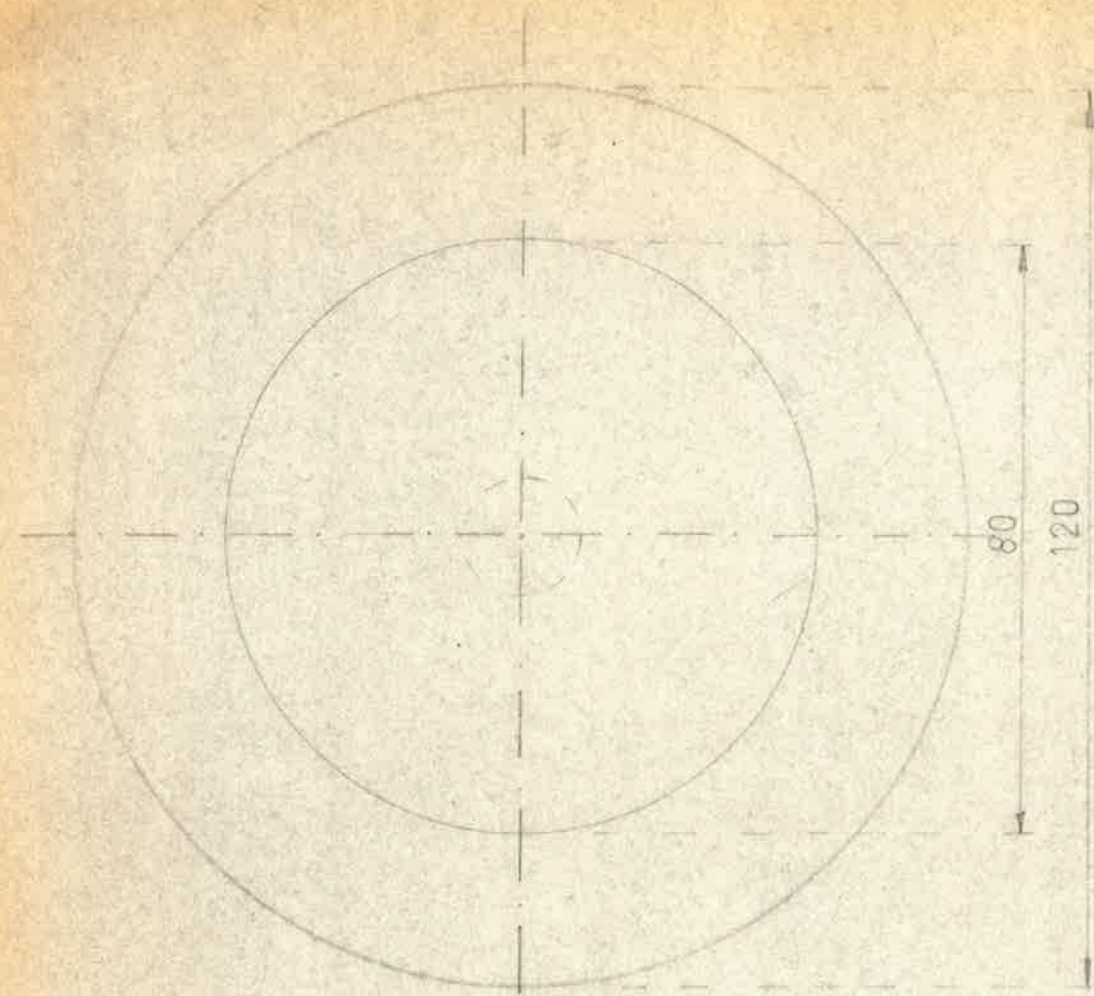

	Joaquin Lloveras Macia	ETSIIB
Escala 1/1	SOPORTE MONOCROMADOR	Nº 1

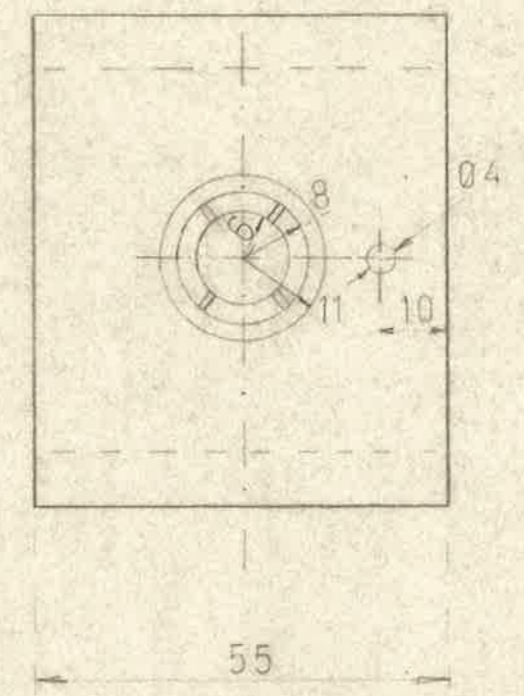
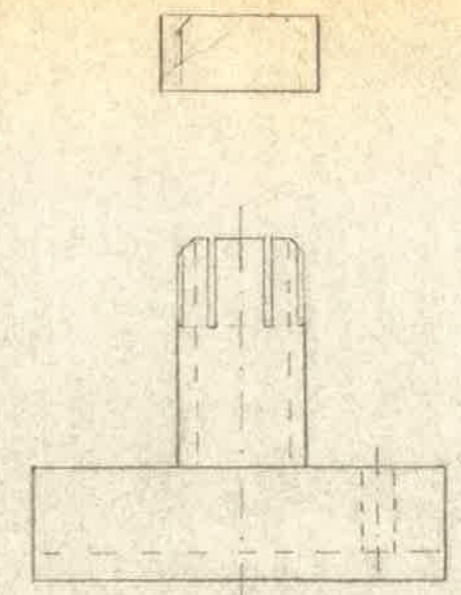
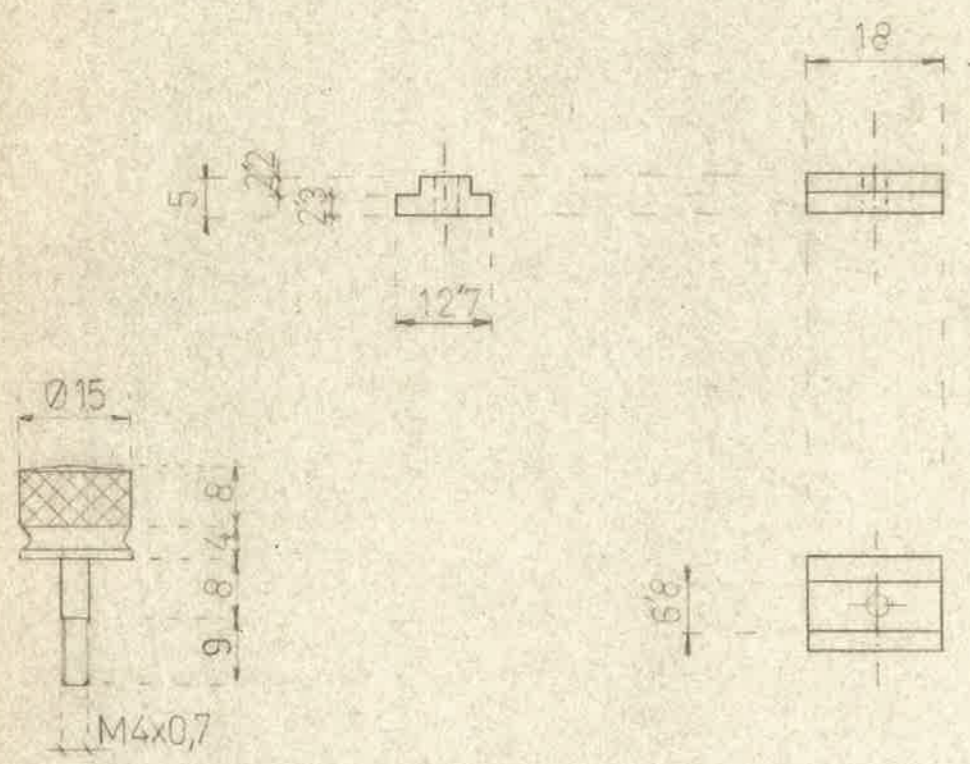
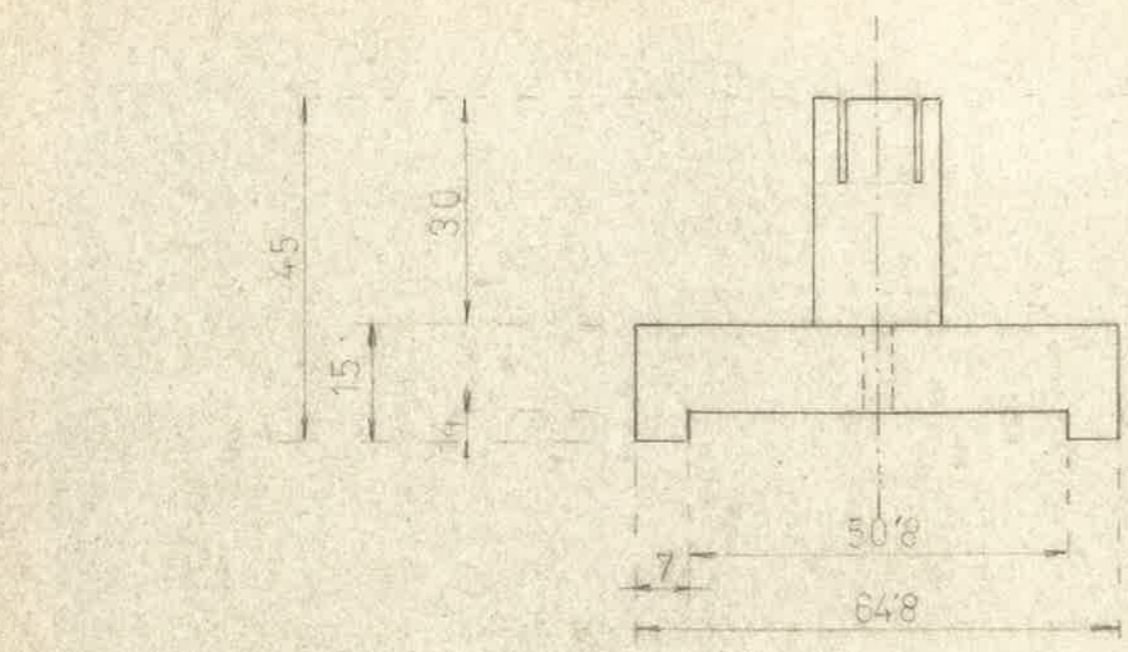

	Joaquín Lloveras Macià	ETSIIB
Escala 1/1	MODULO COMUN DESLIZAMIENTO	Nº 2

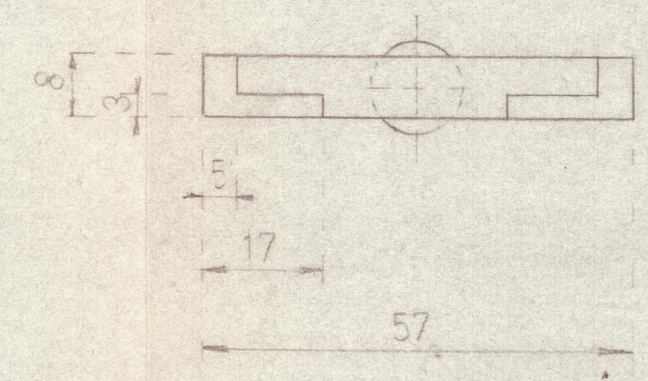
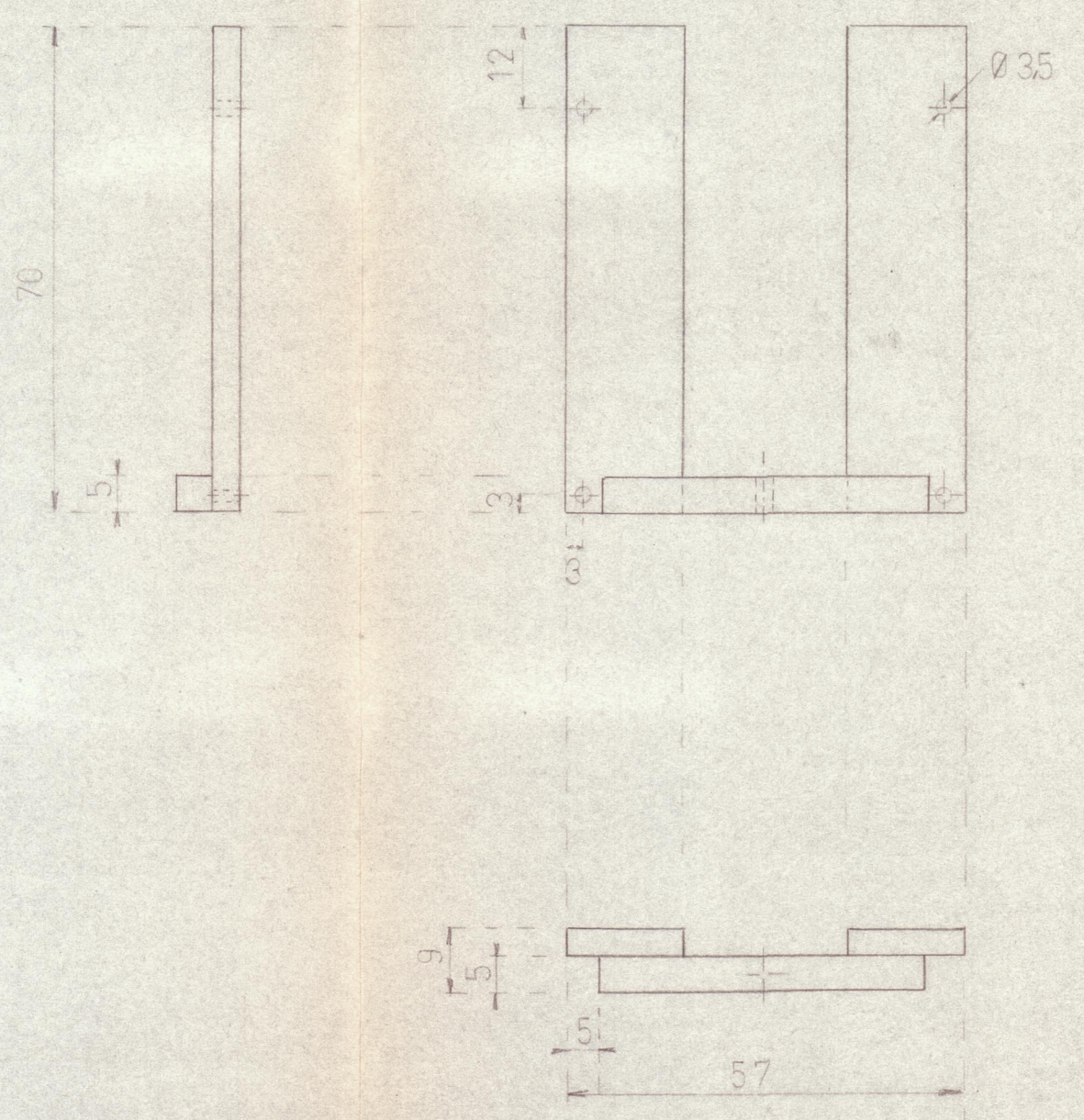
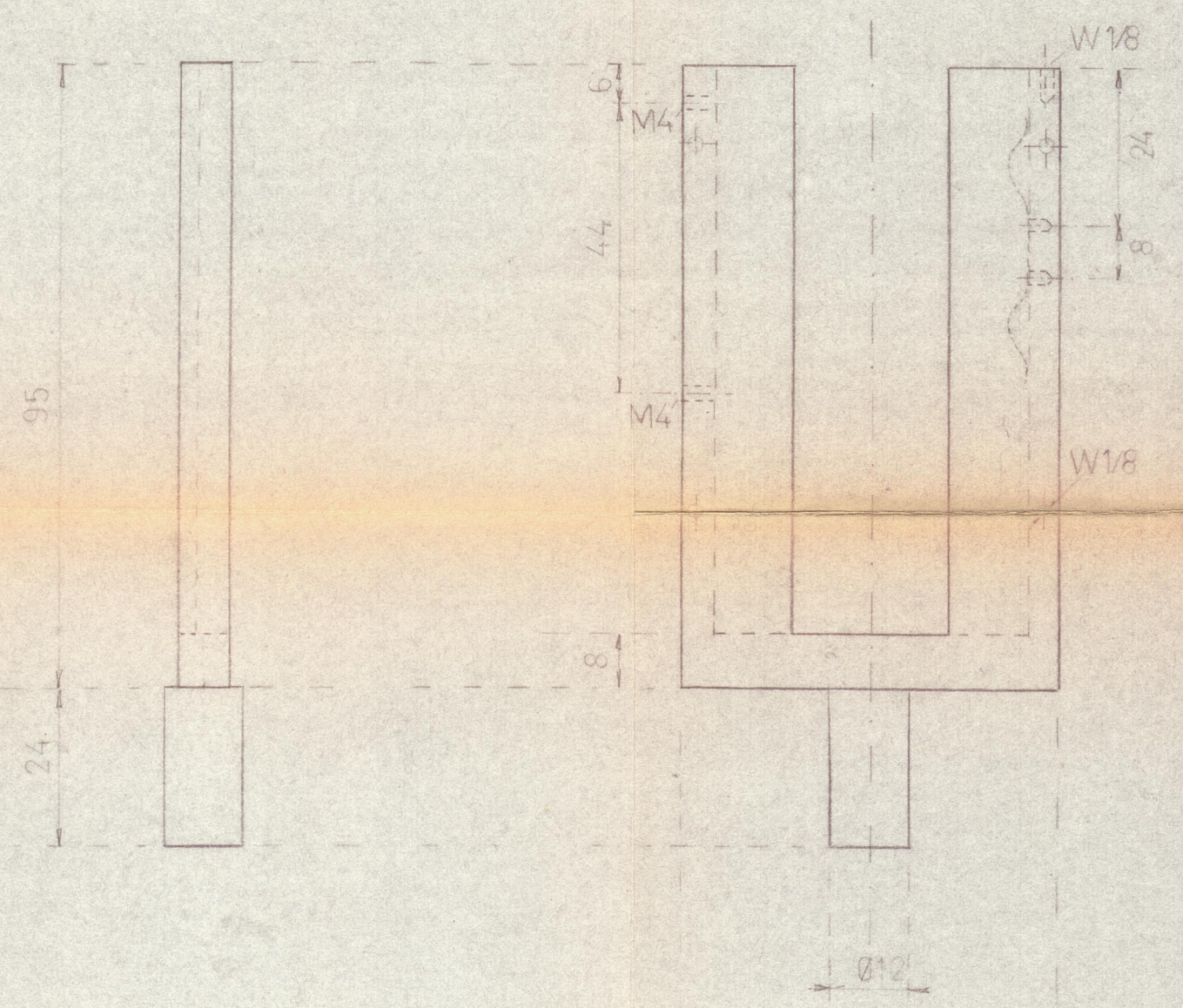
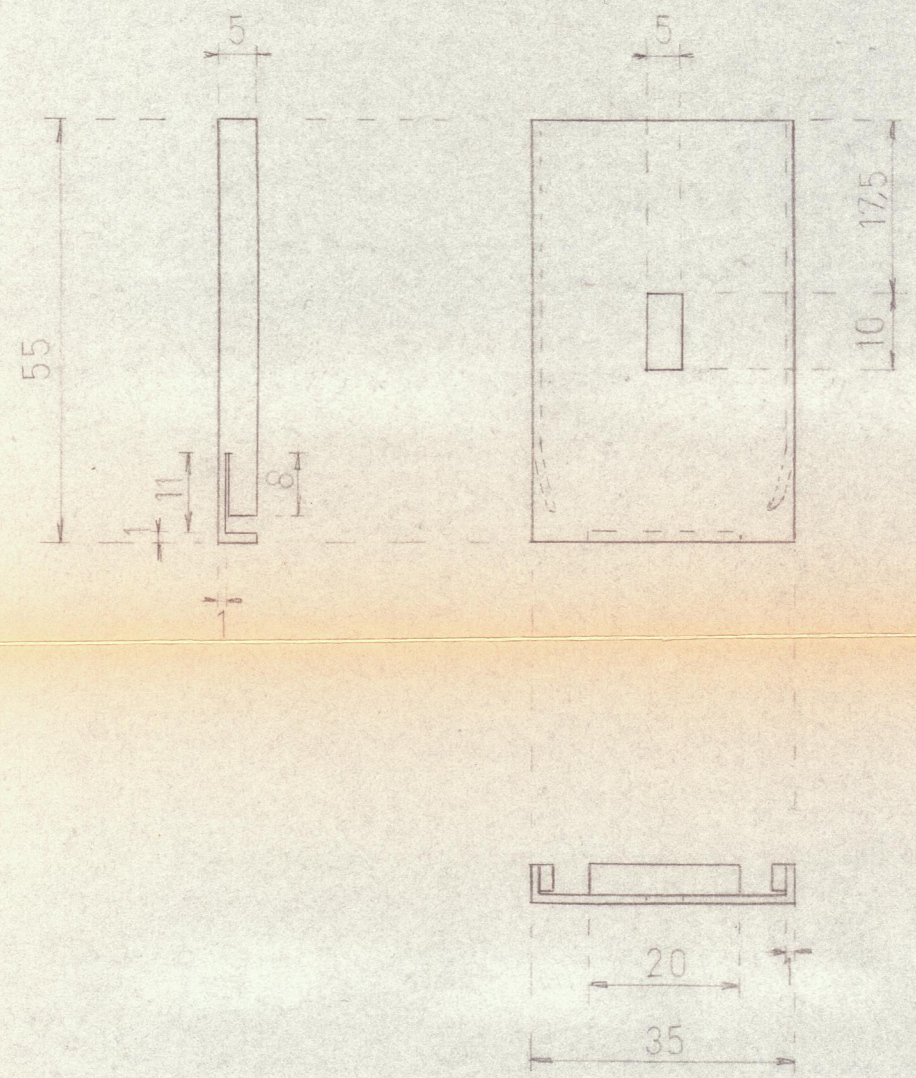

	Joaquín Lloveras Macià	ETSIIB
Escala 1/1	SOPORTE MUESTRA	Nº 3

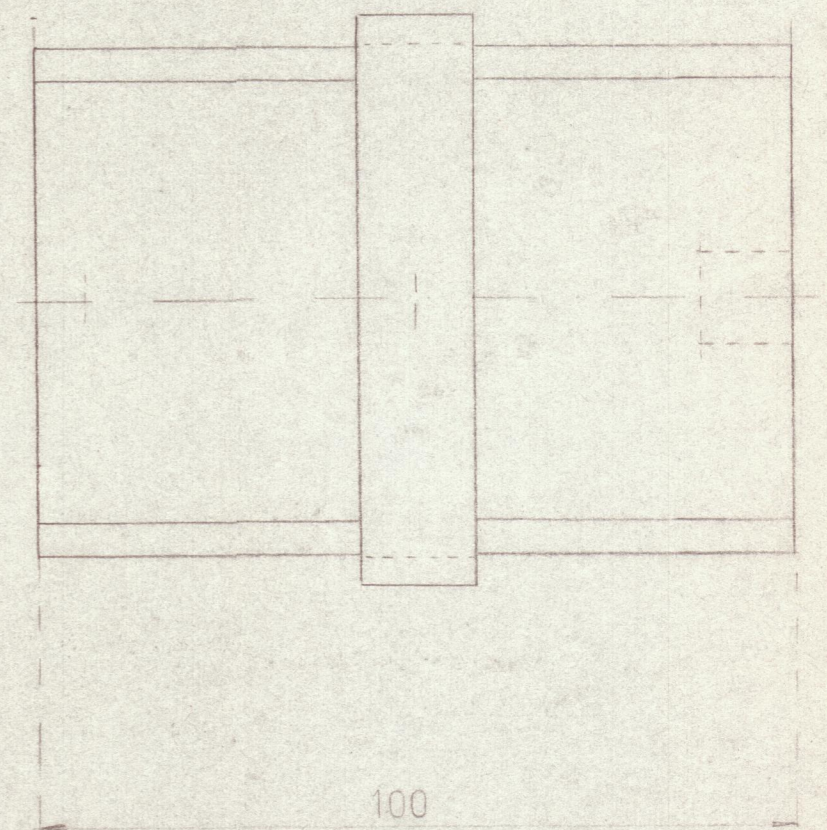
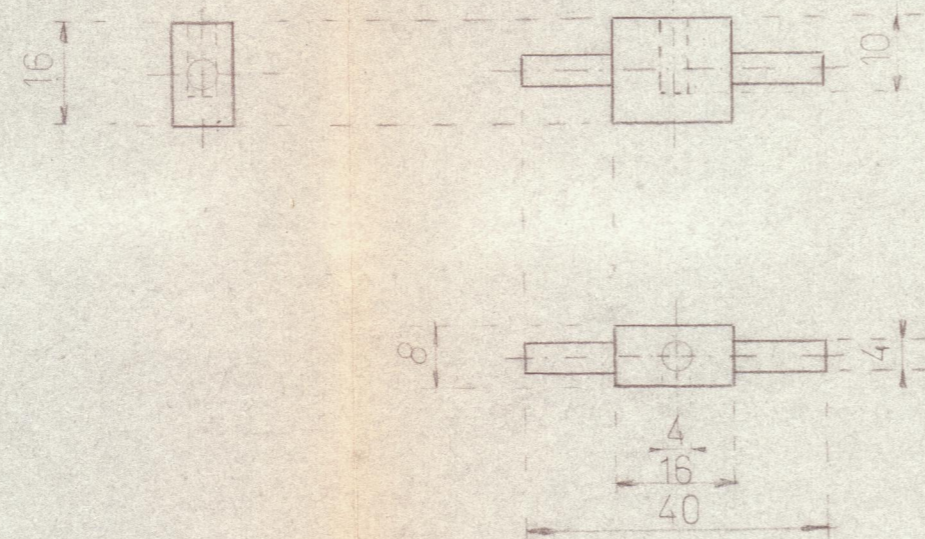
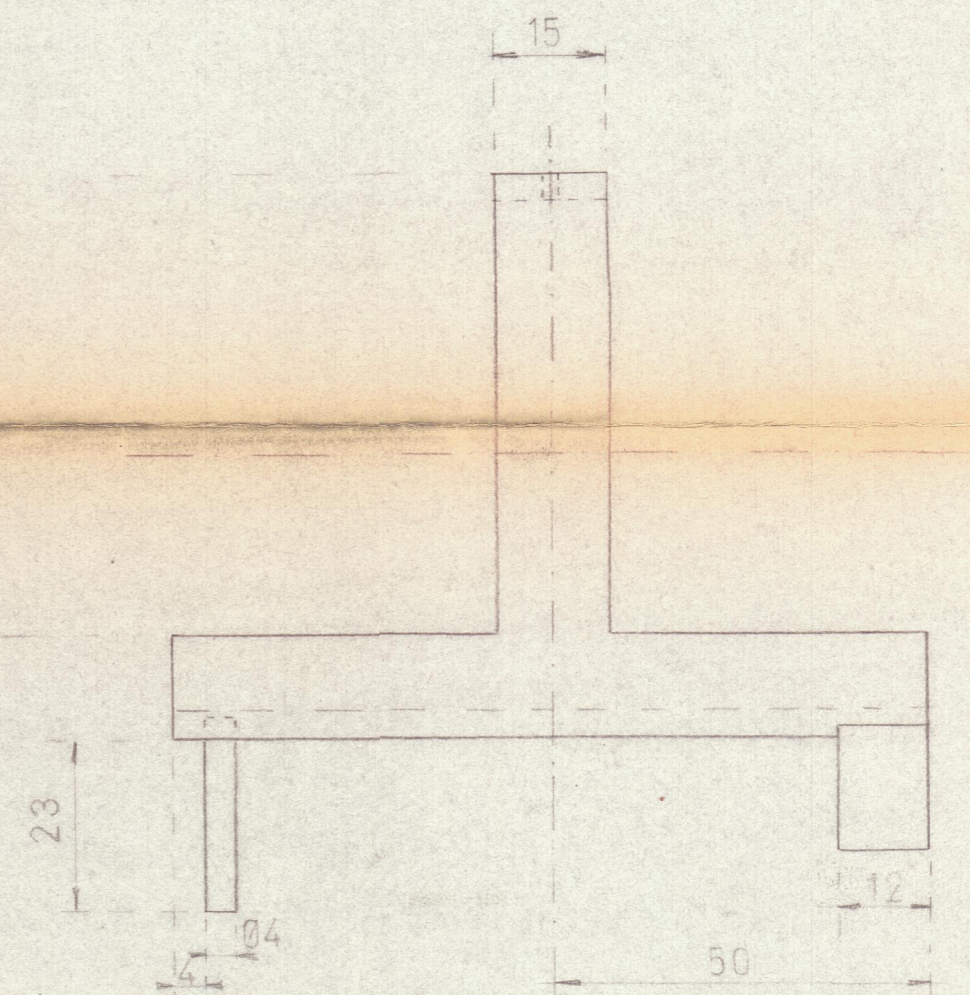
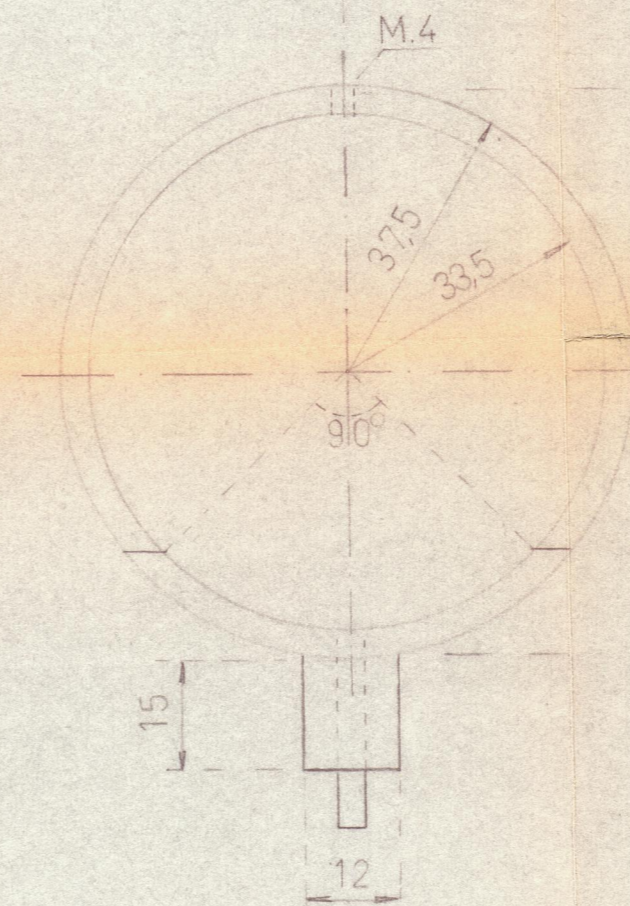
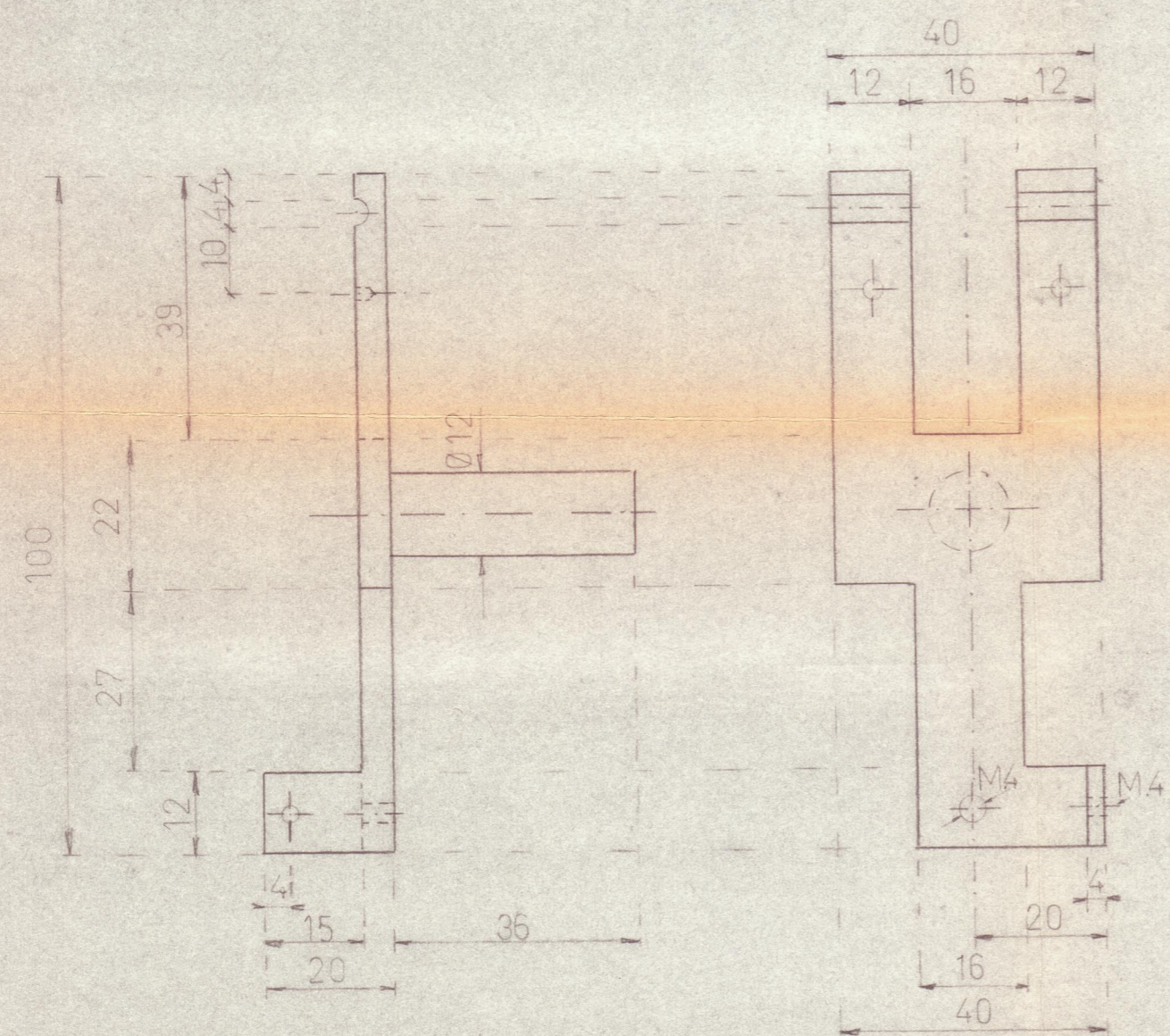

	Joaquin Lloveras Macia	ETSIIB
Escala 1/1	SOPORTE TUBO HIDROGENO	Nº 4

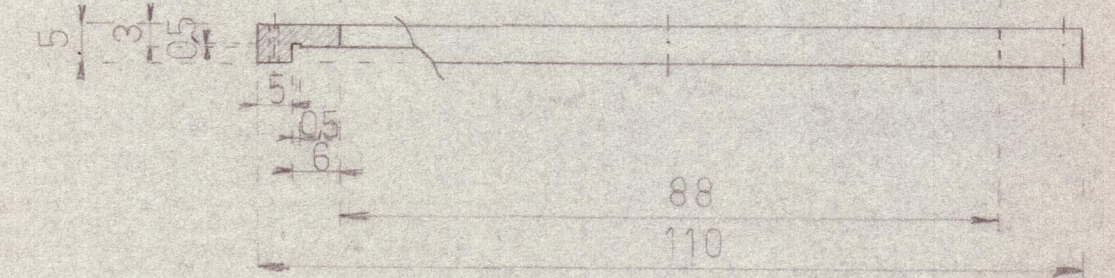
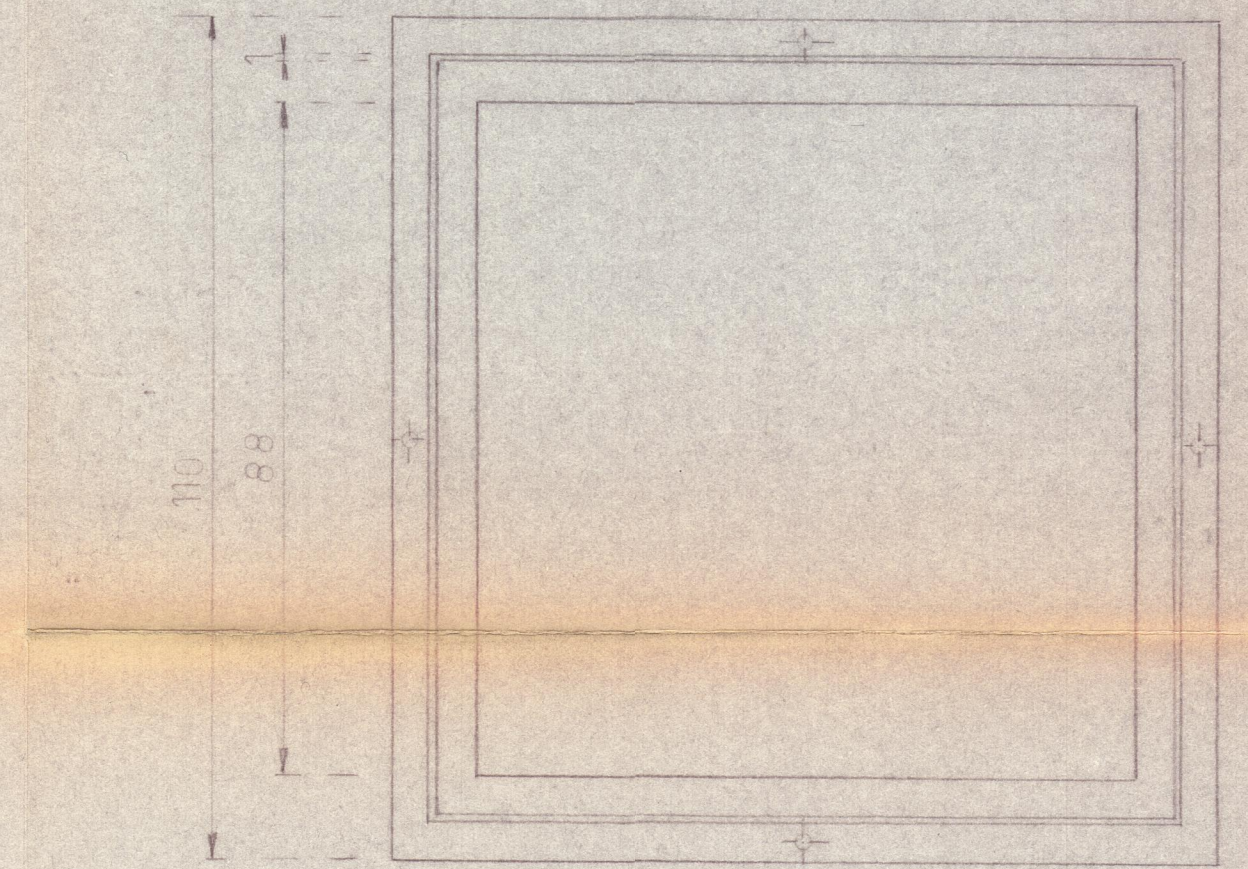
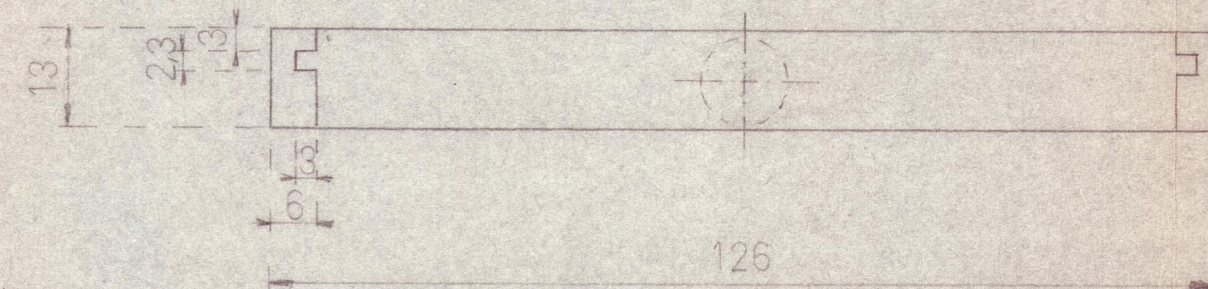
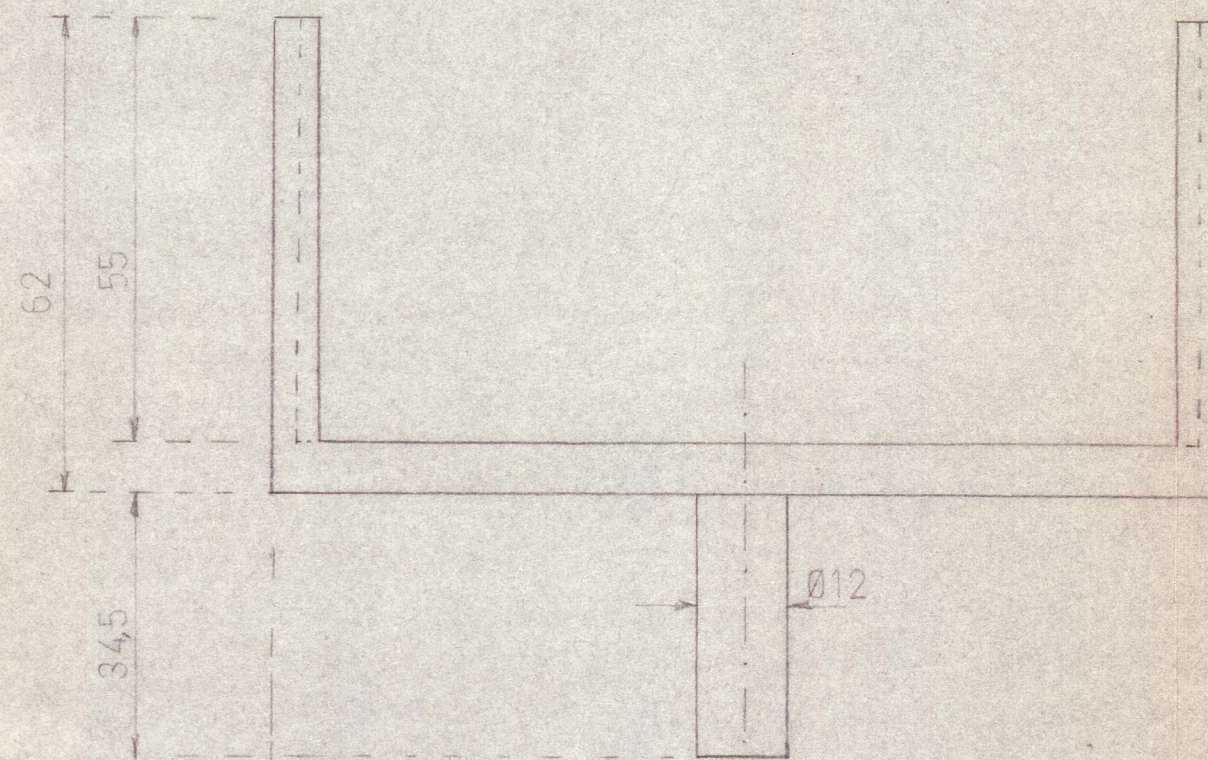
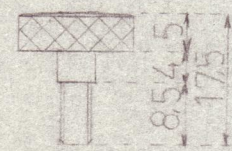
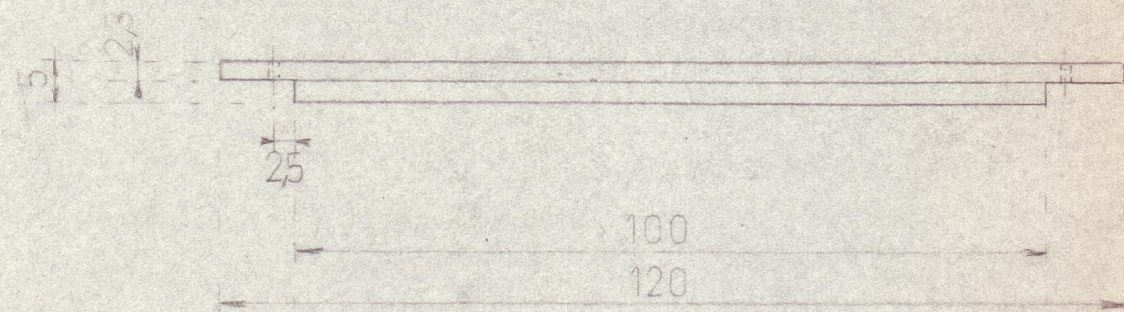
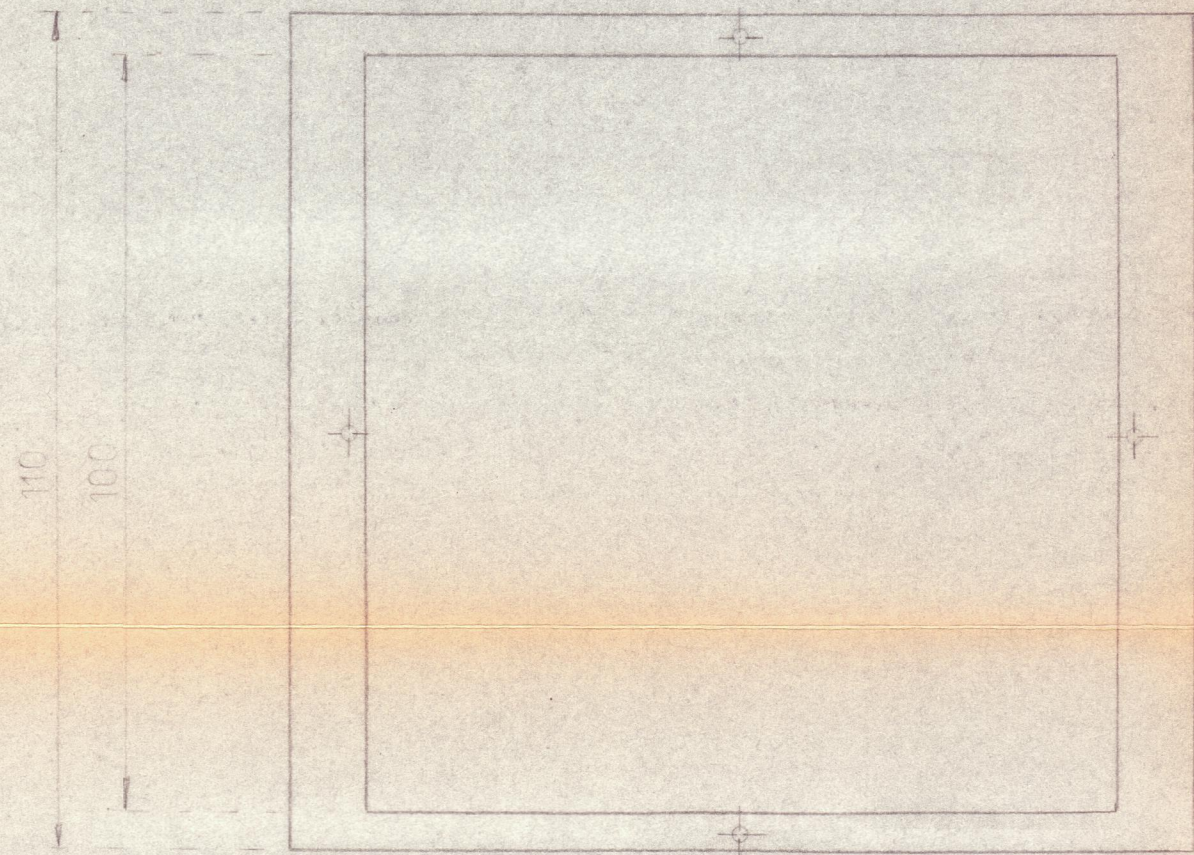

	Joaquín Lloveras Macià	ETSII B
Escala 1/1	SOPORTE PLACA FOTOGRAFICA	Nº 5

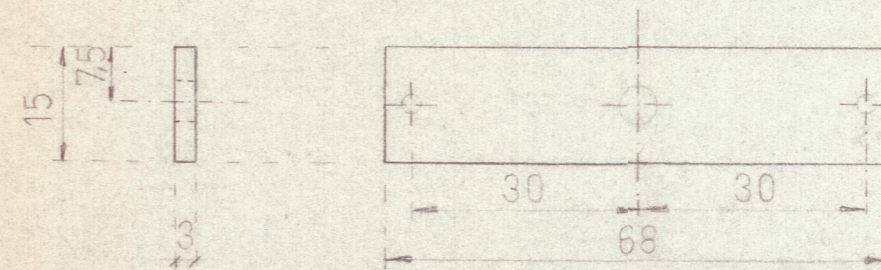
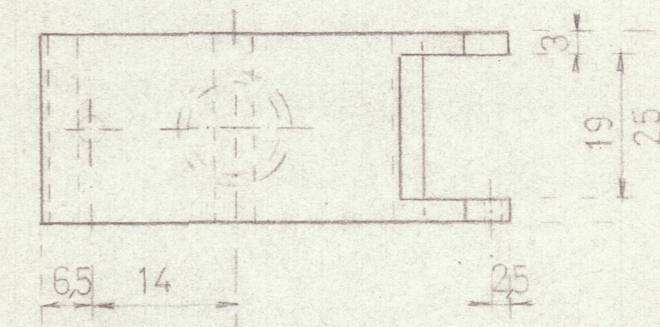
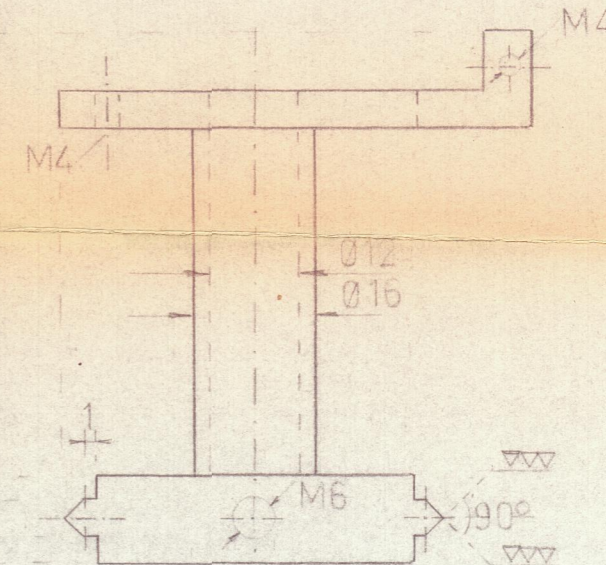
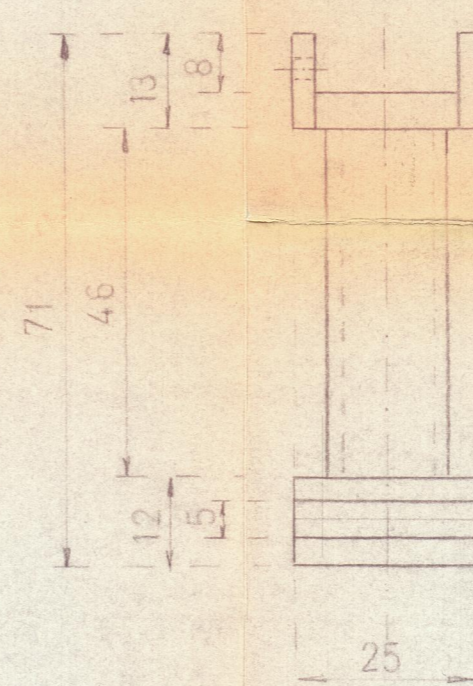
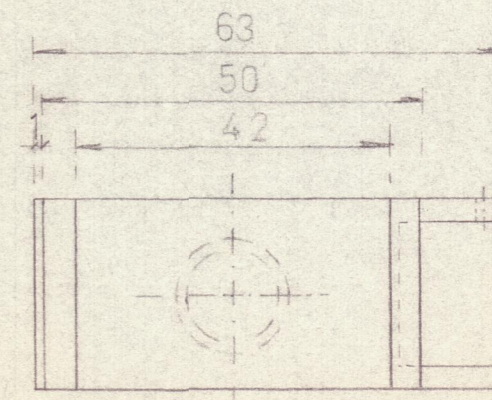
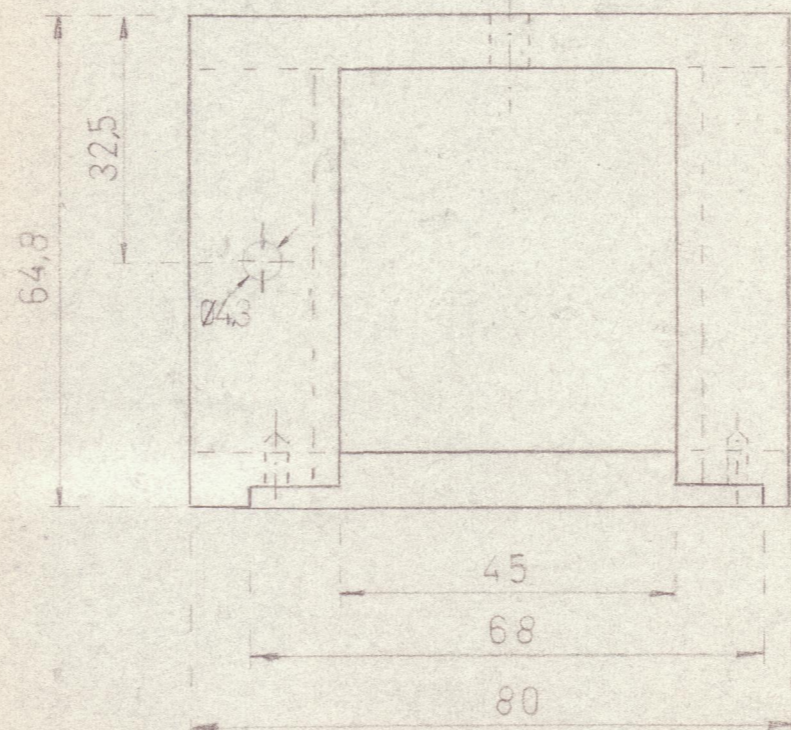
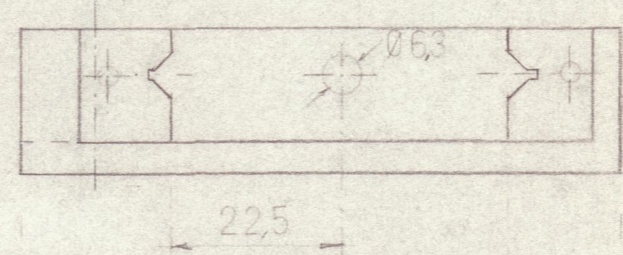
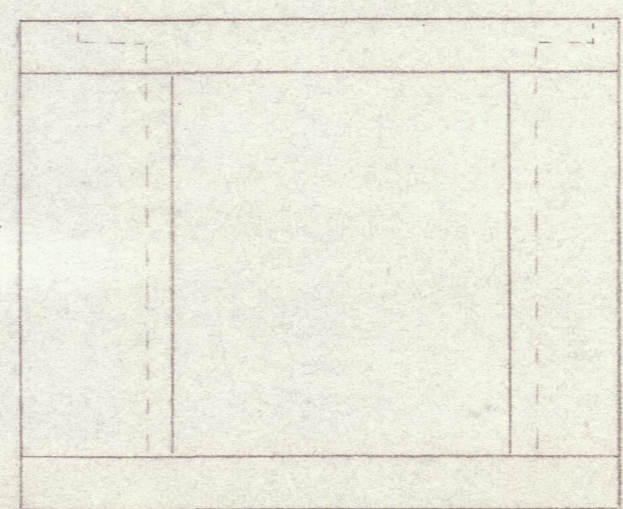
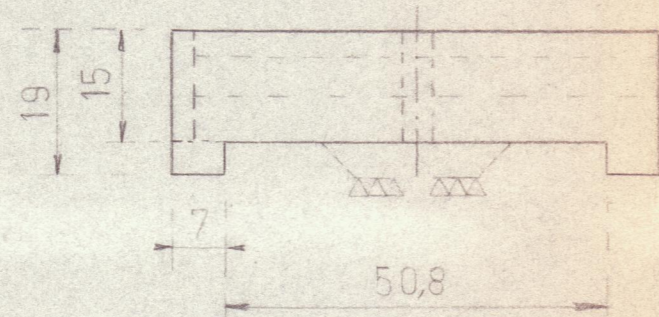
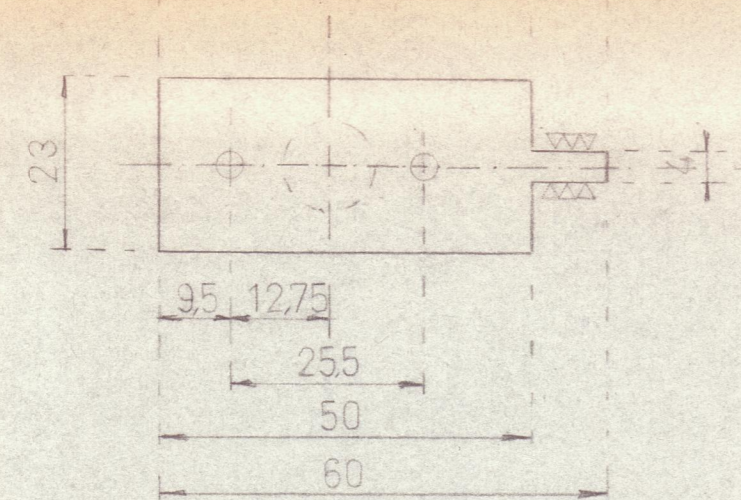
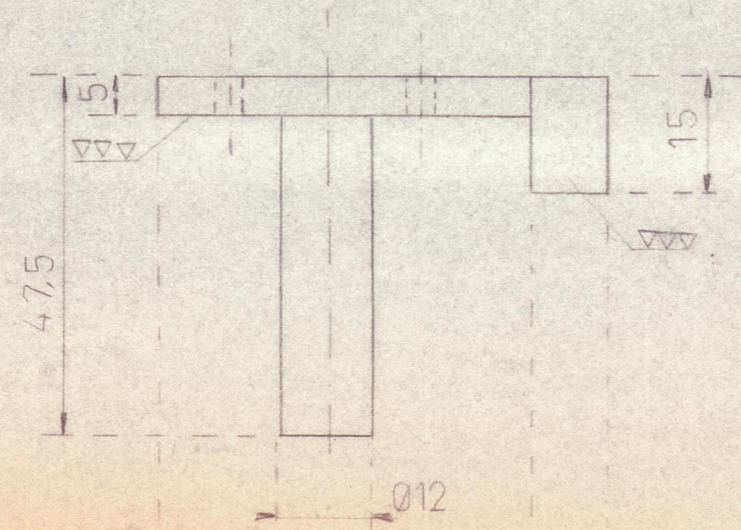

	Joaquin Lloveras Macia	ETSIIB
Escala 1/1	SOPORTE MICROSCOPIO	Nº 6