



UNIVERSITAT DE  
BARCELONA

## El vidre de l'antiguitat tardana a Catalunya i Andorra

Contextos i tipologia del vidre a la Tarraconense Oriental  
entre el baix imperi romà i l'antiguitat tardana (segles IV-VIII)

Joan-Manuel Coll i Riera

**ADVERTIMENT.** La consulta d'aquesta tesi queda condicionada a l'acceptació de les següents condicions d'ús: La difusió d'aquesta tesi per mitjà del servei TDX ([www.tdx.cat](http://www.tdx.cat)) i a través del Dipòsit Digital de la UB ([diposit.ub.edu](http://diposit.ub.edu)) ha estat autoritzada pels titulars dels drets de propietat intel·lectual únicament per a usos privats emmarcats en activitats d'investigació i docència. No s'autoritza la seva reproducció amb finalitats de lucre ni la seva difusió i posada a disposició des d'un lloc aliè al servei TDX ni al Dipòsit Digital de la UB. No s'autoritza la presentació del seu contingut en una finestra o marc aliè a TDX o al Dipòsit Digital de la UB (framing). Aquesta reserva de drets afecta tant al resum de presentació de la tesi com als seus continguts. En la utilització o cita de parts de la tesi és obligat indicar el nom de la persona autora.

**ADVERTENCIA.** La consulta de esta tesis queda condicionada a la aceptación de las siguientes condiciones de uso: La difusión de esta tesis por medio del servicio TDR ([www.tdx.cat](http://www.tdx.cat)) y a través del Repositorio Digital de la UB ([diposit.ub.edu](http://diposit.ub.edu)) ha sido autorizada por los titulares de los derechos de propiedad intelectual únicamente para usos privados enmarcados en actividades de investigación y docencia. No se autoriza su reproducción con finalidades de lucro ni su difusión y puesta a disposición desde un sitio ajeno al servicio TDR o al Repositorio Digital de la UB. No se autoriza la presentación de su contenido en una ventana o marco ajeno a TDR o al Repositorio Digital de la UB (framing). Esta reserva de derechos afecta tanto al resumen de presentación de la tesis como a sus contenidos. En la utilización o cita de partes de la tesis es obligado indicar el nombre de la persona autora.

**WARNING.** On having consulted this thesis you're accepting the following use conditions: Spreading this thesis by the TDX ([www.tdx.cat](http://www.tdx.cat)) service and by the UB Digital Repository ([diposit.ub.edu](http://diposit.ub.edu)) has been authorized by the titular of the intellectual property rights only for private uses placed in investigation and teaching activities. Reproduction with lucrative aims is not authorized nor its spreading and availability from a site foreign to the TDX service or to the UB Digital Repository. Introducing its content in a window or frame foreign to the TDX service or to the UB Digital Repository is not authorized (framing). Those rights affect to the presentation summary of the thesis as well as to its contents. In the using or citation of parts of the thesis it's obliged to indicate the name of the author.

Joan-Manuel Coll i Riera

EL VIDRE DE L'ANTIGUITAT TARDANA A CATALUNYA I ANDORRA

*Contextos i tipologia del vidre a la Tarraconense Oriental entre el baix  
imperi romà i l'antiguitat tardana (segles IV-VIII)*

Tesi Doctoral

Dirigida per Miguel Ángel Cau Ontiveros (UB-ERAAUB)



UNIVERSITAT DE  
BARCELONA

Facultat de Geografia i Història, Departament d'Història i Arqueologia

Secció de Prehistòria i Arqueologia, Universitat de Barcelona

Doctorat en Societat i Cultura, Cursos 2015-2020

**Volum II. Làmines de dibuix**



Volum II

Làmines de dibuix



## Índex de les làmines de dibuix dels jaciments

JACIMENT	Làmines
<b>A. COMARQUES DE GIRONA</b>	
001. LA FONT DEL VILAR (Avinyonet de Puigventós, Alt Empordà)	1-2
002. NECRÒPOLIS DE SANTA MARIA (Roses, Alt Empordà)	2
003. PUIG ROM (Roses, Alt Empordà)	3-4
004. CARRETERA DE SANT MARTÍ D'EMPÚRIES (L'Escala, Alt Empordà)	5-6
005. CAMÍ DE SANT FELIU DE LA GARRIGA (Viladamat, Alt Empordà)	7-8
006. PLA DE PALOL (Platja d'Aro, Baix Empordà)	9-22
007. RASET DE BAIX (Cervià de Ter, Gironès)	23
PLA DE L'HORTA (Sarrià de Ter, Gironès)	23
008. LES GOGES (Sant Julià de Ramis, Gironès)	24
009. EL CASTELLUM (Sant Julià de Ramis, Gironès)	24
010. VILAUBA (Camós, Pla de l'Estany)	25-27
011. L'AUBERT (Vall d'en Bas, La Garrotxa)	28
012. ELS AMETLLERS (Tossa de Mar, La Selva)	28
<b>B. COMARQUES DE BARCELONA</b>	
013. EL MORÉ (Sant Pol de Mar, Maresme)	29-32
014. TORRE LLAUDER (Mataró, Maresme)	33-40
<b>-Contextos urbans de Mataró-</b>	
015. C/ SANTA MARIA 10 (Mataró, Maresme)	41
016. C/ MAGÍ DE VILALLONGA 8-12 (Mataró, Maresme)	41-42
017. EL CARRERÓ 49 (Mataró, Maresme)	42-44
018. C/ LA PALMA 15 (Mataró, Maresme)	44-46
019. C/ LA PALMA 2004 (Mataró, Maresme)	47
020. EL CARRERÓ 21-25 (Mataró, Maresme)	48
021. C/ SANT SIMÓ 2-4 (Mataró, Maresme)	48
022. PLAÇA BEAT SALVADOR (Mataró, Maresme)	49
023. CAN CRUZATE (Mataró, Maresme)	50-57
024. C/ XAMMAR 2 (Mataró, Maresme)	58
025. CA LA MADRONA (Mataró, Maresme)	59
026. CAN MODOLELL (Cabreria Mar, El Maresme)	59
027. HORTA FARRERONS (Premià de Mar, Maresme)	60-65
028. CARRER PUJOL 36 (Badalona, Barcelonès)	66-67
<b>-Contextos urbans de BCN-</b>	
029. C/ SANT HONORAT 1-3 (Barcelona, Barcelonès)	68-76
030. C/ CIUTAT 3 (Barcelona, Barcelonès)	77-78
031. AVINGUDA CAMBÓ (Barcelona, Barcelonès)	79
032. ARXIU ADMINISTRATIU (Barcelona, Barcelonès)	80-81
033. LA PLAÇA DEL REI (Barcelona, Barcelonès)	82
034. SANT MARTÍ (Aiguafreda de Dalt, Vallès Or.)	83-89
035. CAN TERRÉS (La Garriga, Vallès Or.)	90
036. CA L'ESTRADA (Canovelles, Vallès Or.)	90

037. EL PLA DEL SERRADOR (Les Franqueses, Vallès Or.)	90
038. C/ GAIETÀ VENTALLÓ (Mollet, Vallès Or.)	90
039. CAN CABASSA (Sant Cugat del Vallès, Vallès Occ.)	91-114
040. MONESTIR DE ST. CUGAT (Sant Cugat, Vallès Occ.)	115-119
041. CAN MARCET (Sant Cugat del Vallès, Vallès Occ.)	120-121
042. C/ VIA AUGUSTA 129 (Sant Cugat, Vallès Occ.)	122
043. CAN SANT JOAN (Sant Cugat del Vallès, Vallès Occ.)	122
044. LA BASTIDA (Rubí, Vallès Occ.)	123-128
045. CA N'ORIOIOL (Rubí, Vallès Occ.)	129-130
046. C/ DOCTOR TURRÓ 8 (Rubí, Vallès Occ.)	131
047. C/SANT IGNASI – C/XERCAVINS (Rubí, Vallès Occ.)	131
048. CARRETERA DE SABADELL 83-85 (Rubí, Vallès Occ.)	131
049. SEU EPISCOPAL D'ÈGARA (Terrassa, Vallès Occ.)	132-196
050. C/ RECTORIA 16 (Terrassa, Vallès Occ.)	197-198
051. C/ MAJOR DE SANT PERE 15 (Terrassa, Vallès Occ.)	198
052. C/ PUIG I CADAFALCH 36 (Terrassa, Vallès Occ.)	199
053. C/ PUIG I CADAFALCH 42 (Terrassa, Vallès Occ.)	199
054. CAN BOSCH DE BASEA (Terrassa, Vallès Occ.)	200-201
055. L'AIGUACUIT (Terrassa, Vallès Occ.)	202-212
056. CAN FONOLLET (Terrassa, Vallès Occ.)	212
057. CAN BONVILAR (Terrassa, Vallès Occ.)	213-214
058. ELS CAMPS DE CAN COLOMER (Terrassa, Vallès Occ.)	215-221
059. VINYA DE LA SALUT (Viladecavalls, Vallès Occ.)	222-223
060. CAN SOLÀ DEL RACÓ (Matadepera, Vallès Occ.)	224-227
061. LA PLAÇA MAJOR (Castellar del Vallès, Vallès Occ.)	228-240
062. CAN PALAU (Sentmenat, Vallès Occ.)	241-245
063. COVA DE GUANTA (Sentmenat, Vallès Occ.)	245
064. ESGLÉSIA VELLA DE SANT MENNA (Sentmenat, Vallès Occ.)	246
065. ESGLÉSIA DE SANT SALVADOR (Polinyà, Vallès Occ.)	247
066. LA BÒBILA BELL-SOLÀ (Santa Perpètua, Vallès Occ.)	247
067. CAN BERNADES (Santa Perpètua de M., Vallès Occ.)	247
068. CAN VINYALET (Santa Perpètua de M., Vallès Occ.)	247
069. SANTIGA (Santa Perpètua de Mogoda, Vallès Occ.)	248
070. LA SALUT – ARRAGONEM (Sabadell, Vallès Occ.)	249-253
071. CAN ROQUETA-TORRE ROMEU (Sabadell, Vallès Occ.)	254
072. CASTELLARNAU (Sabadell, Vallès Occ.)	255
073. CAN FEU (Sant Quirze del Vallès, Vallès Occ.)	256
074. CAN GAMBÚS 1 (Sabadell, Vallès Occ.)	257-269
075. EL POBLE-SEC (Sabadell, Vallès Occ.)	270
076. SANT PAU DE RIU-SEC (Sabadell, Vallès Occ.)	271
077. ELS MALLOLS (Cerdanyola del Vallès, Vallès Occ.)	272-276
078. EL FONDAL DE VALLDELLÓS (Mediona, Alt Penedès)	277
079. CAN SIMÓ (Sant Llorenç d'Hortons, Alt Penedès)	277
080. C/ GENERALITAT 22 (Gavà, Baix Llobregat)	278
081. LA SOLANA (Cubelles, El Garraf)	279-282

### C. COMARQUES DE CATALUNYA CENTRAL

082. CAN COLOMER-MUNMANY (Vic, Osona)	283
083. COLLET DELS CLAPERS –SEGUERS- (Pinós, Solsonès)	283
084. LA VINYA D'OGERN (Bassella, Alt Urgell)	283
085. L'ESPELT (Òdena, Anoia)	283

086. LA PAÏSSA DELS PLANELL (Monistrol de C., Bages)	283
087. VILA CLARA (Castellfollit del Boix, Bages)	284
088. SERRAT DELS TRES HEREUS (Casserres, Berguedà)	285

#### **D. COMARQUES DEL CAMP DE TARRAGONA**

089. ELS MUNTS (Altafulla, Tarragonès)	286-287
090. ELS ANTIGONS (Reus, Baix Camp)	288-294

##### **-Contextos urbans de Tarragona-**

091. C/ CASTANYOS 1 (Tarragona, Tarragonès)	295-308
092. JARDÍ DEL CLAUSTRE DE LA CATEDRAL (Tarragona, Tarragonès)	309-330
093. HOSPITAL VELL DE SANTA TECLA (Tarragona, Tarragonès)	331-337
094. C/ VILA-ROMA (Tarragona, Tarragonès)	338-344
095. LA BASÍLICA DE L'AMFITEATRE (Tarragona, Tarragonès)	345
096. NECRÒPOLIS PALEOCRISTIANA -FONS ANTIC-	346-355
097. NECRÒPOLIS PALEOCRISTIANA -CAIXA REFORMES 1987-	356-374
098. PARCEL·LA 22b del PERI-2 (Tarragona, Tarragonès)	375-392
099. PARCEL·LA 24 del PERI-2 (Tarragona, Tarragonès)	393-401
100. C/ MANUEL DE FALLA (Tarragona, Tarragonès)	402
101. EL PARC DE LA CIUTAT (Tarragona, Tarragonès)	403
102. MAS MALLOL-MAS RIMBAU (Tarragona, Tarragonès)	403
103. LA LLOSA (Cambrils, Baix Camp)	404
104. LA TORRE BARGALLONA (Cambrils, Baix Camp)	404
105. LES ROQUES DE VILAVELLA (Riudecols, Baix Camp)	404
106. VILARDIDA (Montferri, Alt Camp)	405-410
MAS D'EN VERD DE FARENA (Mont-ral, Alt Camp)	410

#### **E. COMARQUES DE TERRES DE L'EBRE**

107. EL MAS DEL CATXORRO (Benifallet, Baix Ebre)	411
108. BARRUGAT (Bítem-Tortosa, Baix Ebre)	412
109. EL MAS DEL MAURICI (Riba-roja, Ribera d'Ebre)	413
110. LA CARROVA (Amposta, Montsià)	414

#### **F. COMARQUES DE LLEIDA**

111. CONTEXTOS D'IESSO (Guissona, La Segarra)	415-417
112. EL BOVALAR (Seròs, Segrià)	418-422
113. LA FOGONUSSA (Sant Martí de Riucorb, L'Urgell)	423-424
114. EL TOSSAL DEL MORO (Castellserà, L'Urgell)	425

#### **G. COMARQUES DE L'ALT PIRINEU I ARAN**

115. CAVITAT M-35 (Baix Pallars, Pallars Sobirà)	426
116. LA COVA COLOMERA (Sant Esteve de la Sarga, Pallars Jussà)	426-427

#### **H. ANDORRA**

117. ROC D'ENCLAR (Santa Coloma, Andorra)	428-430
118. CAMP VERMELL (Sant Julià de Lòria, Andorra)	430





LÀMINES



UE.35-78

UE.62

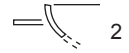
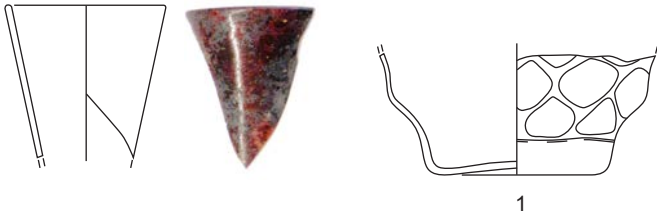

UE.79

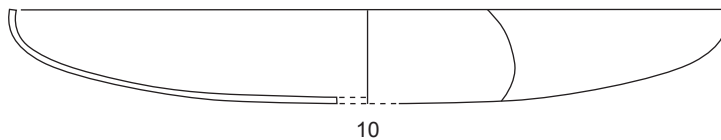
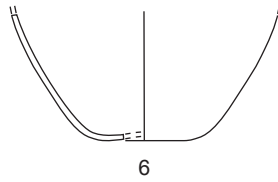
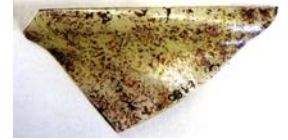
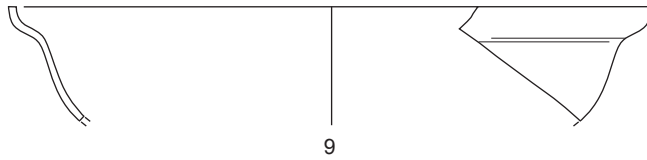
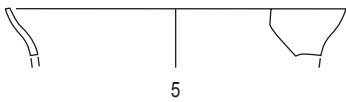
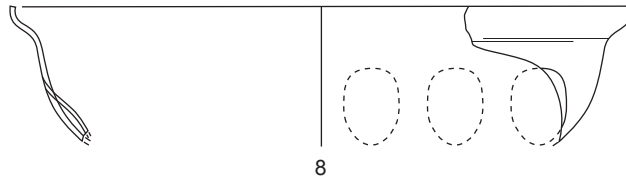
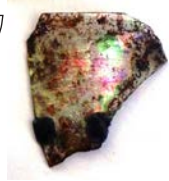
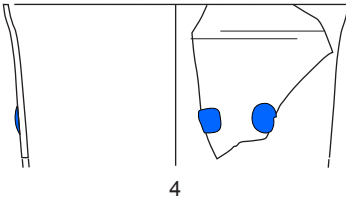
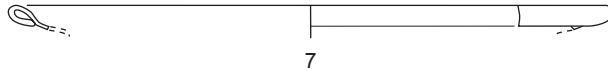
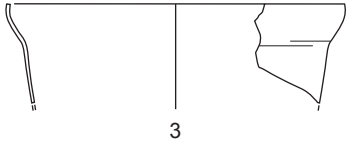

UE.92

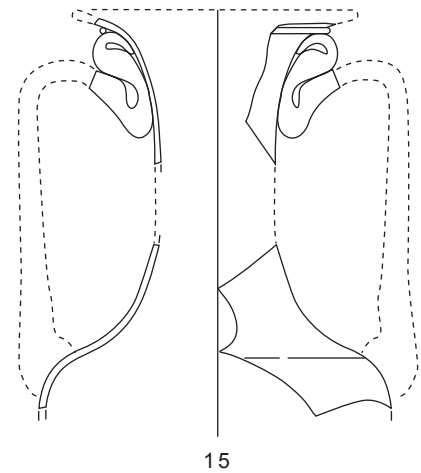
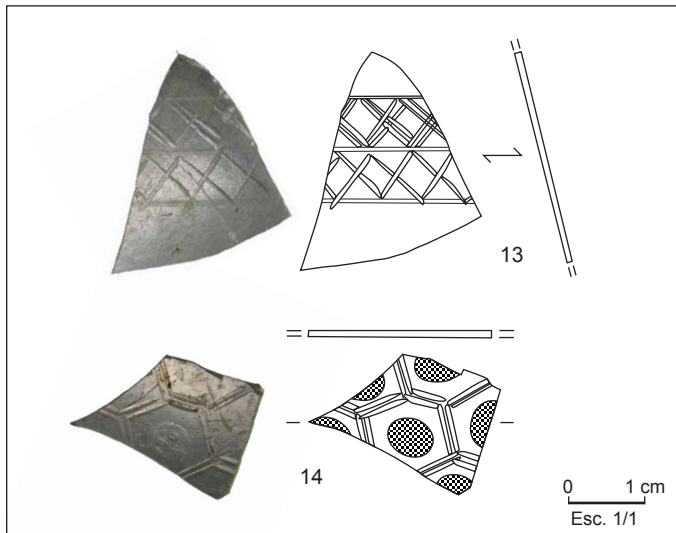
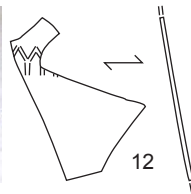
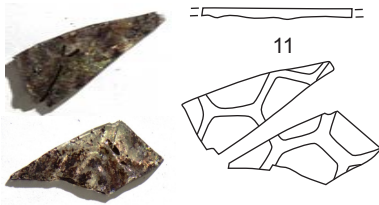

15

16

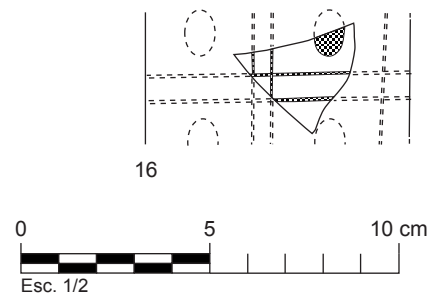

UE.113



17

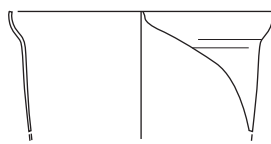

18



19

UE.117



20



UE.118



21

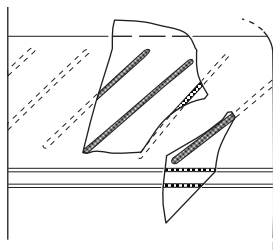

Superficial 1983

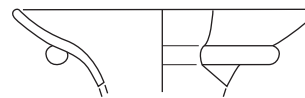

22

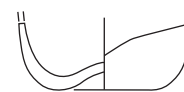

23

Necròpolis de Santa Maria (Roses)

Tomba 30

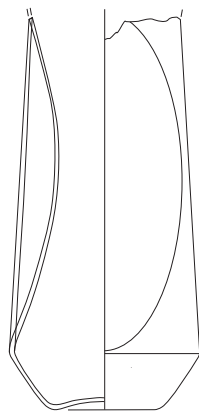

1

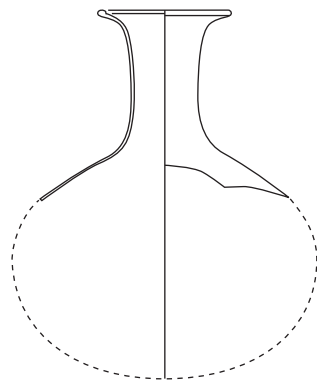

2



3



4



5



6



7

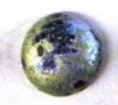

8



9

Tomba 9

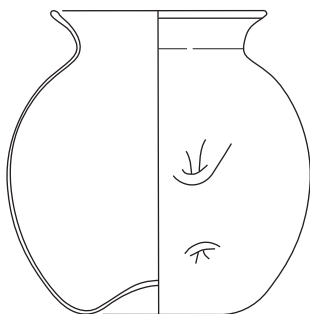

10



Tomba 3

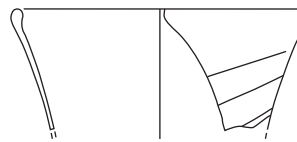

11

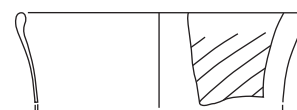
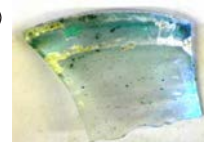

12

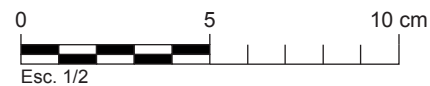

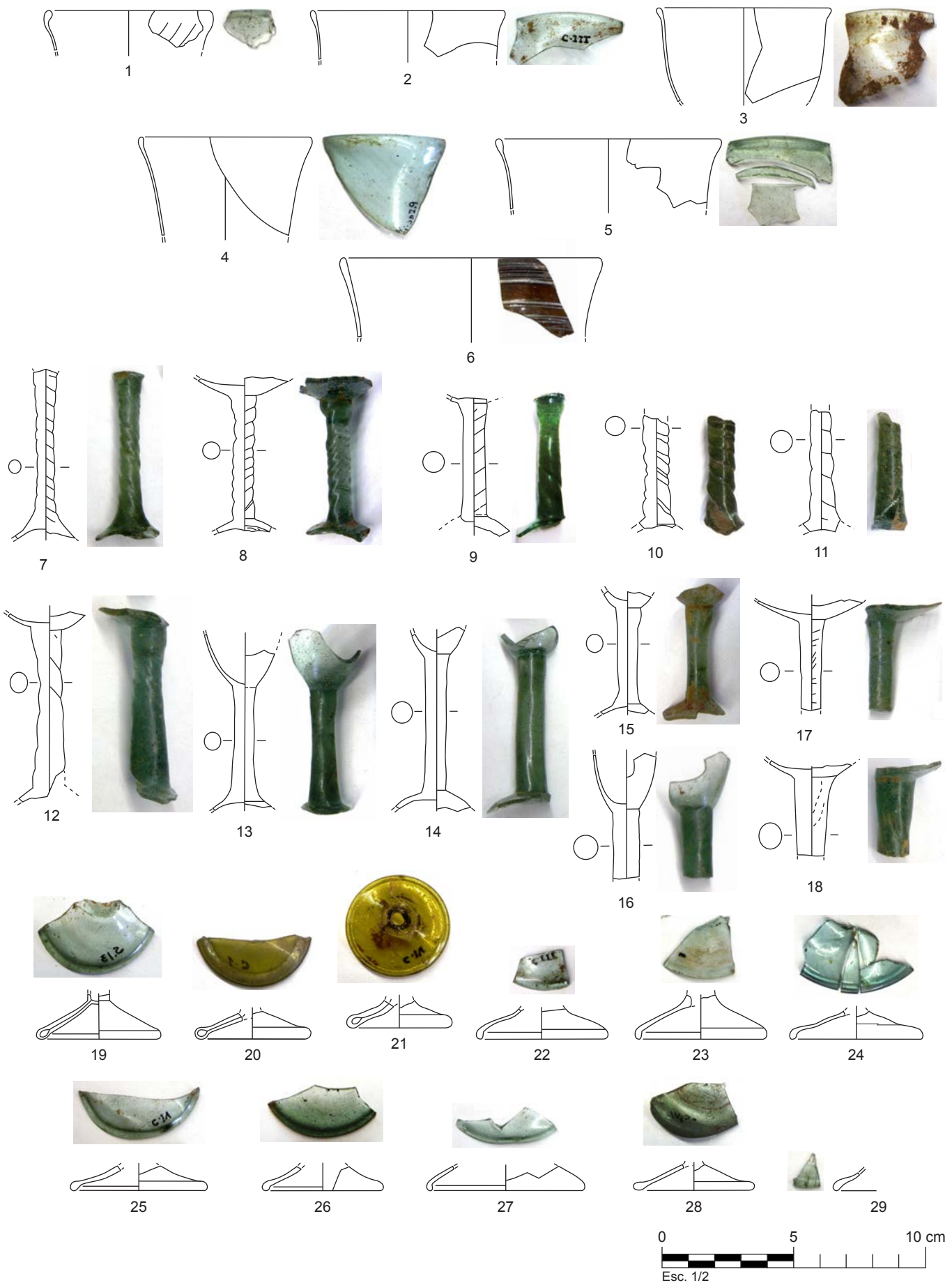

PUIG ROM (Roses, Alt Empordà), 1946-1947  
 Context general  
 Cronologia: s.VII-VIII



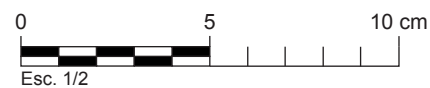
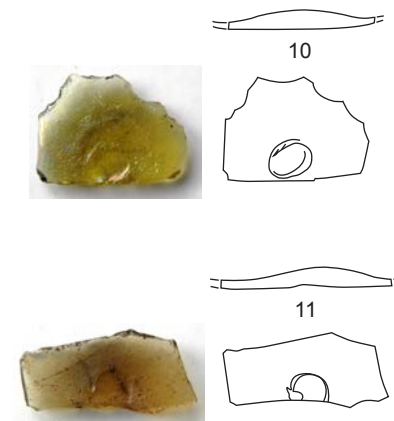
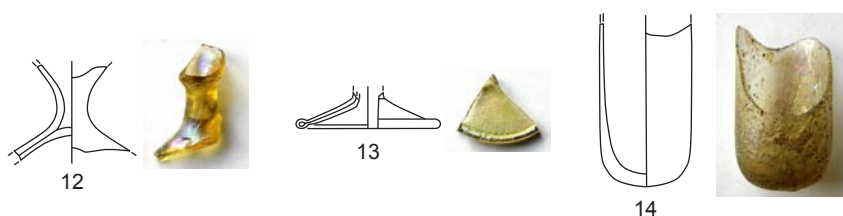
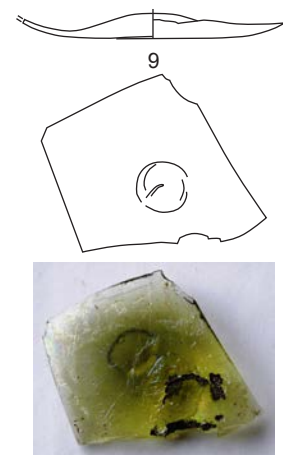
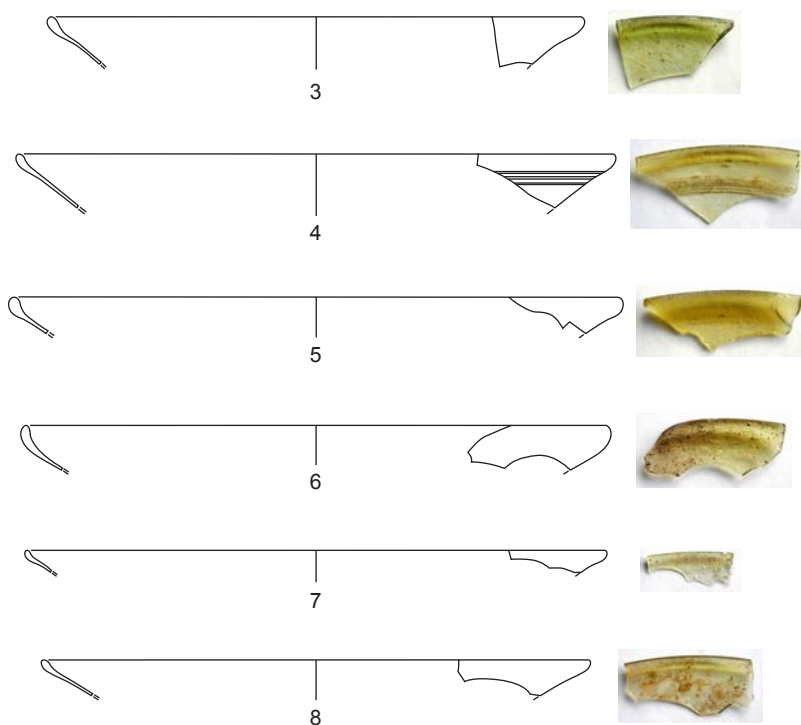
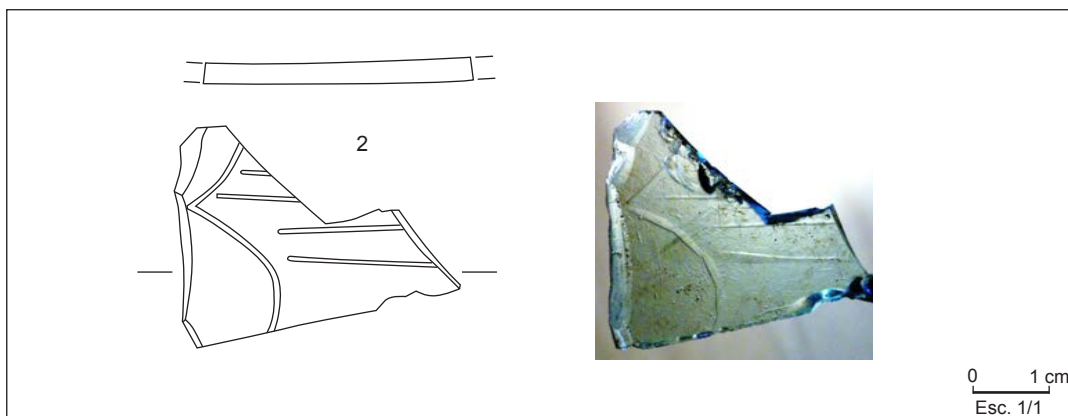
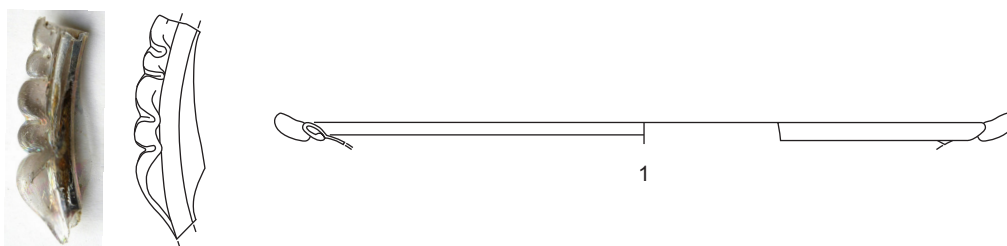



UE.802

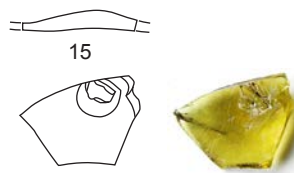

UE.837

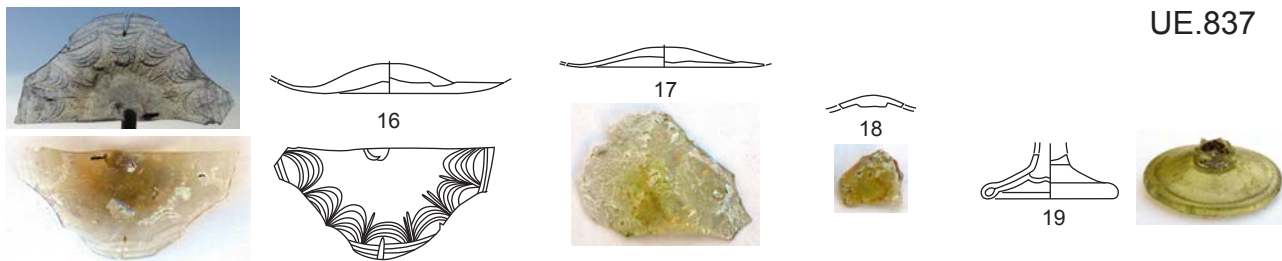

UE.844

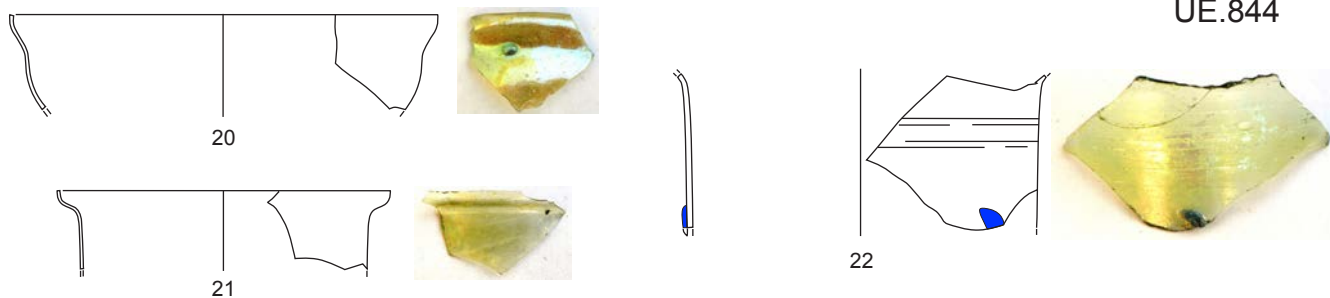

UE.1009

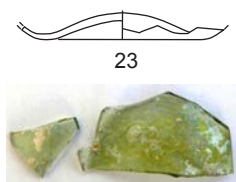

UE.1318

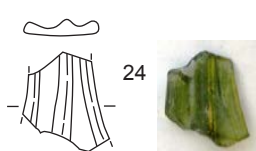

UE.1325

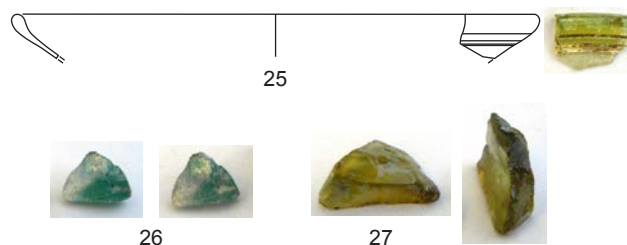

UE.1406

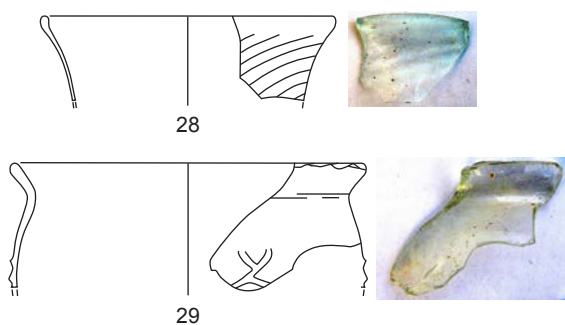

UE.1412

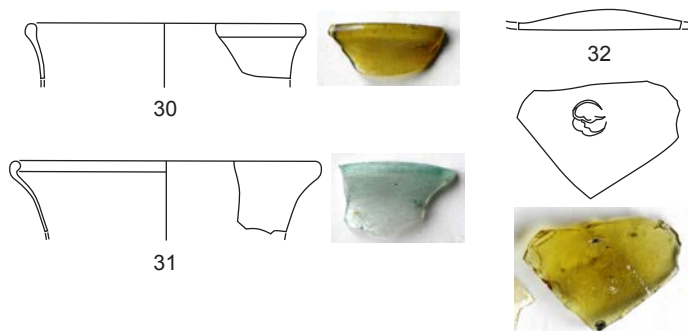

UEs.1331=1414

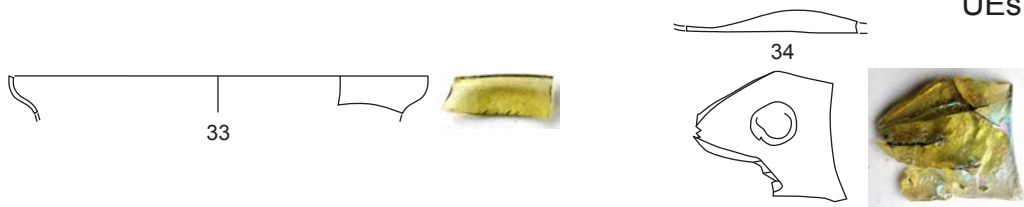

UE.1004

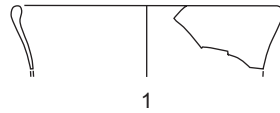

1

UE.3011

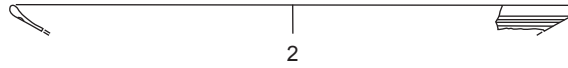

2

UE.4005

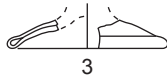

3

UE.4006

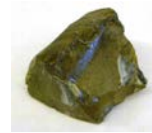

Nucli de vidre en brut

UE.4024

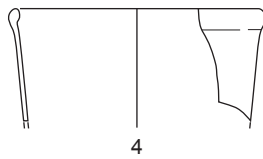

4

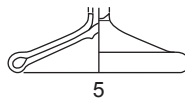

5

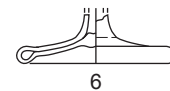

6

UE.4030

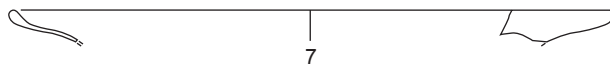

7



10

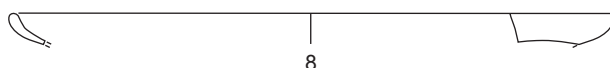

8

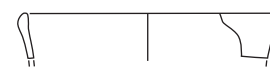

11



9



12

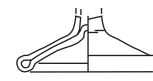

13

UE.4037



14

UE.4043

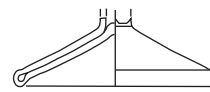

15

UE.4058

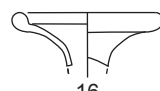

16

UE.4063



17

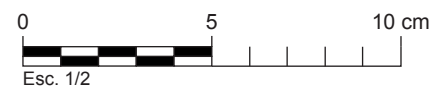

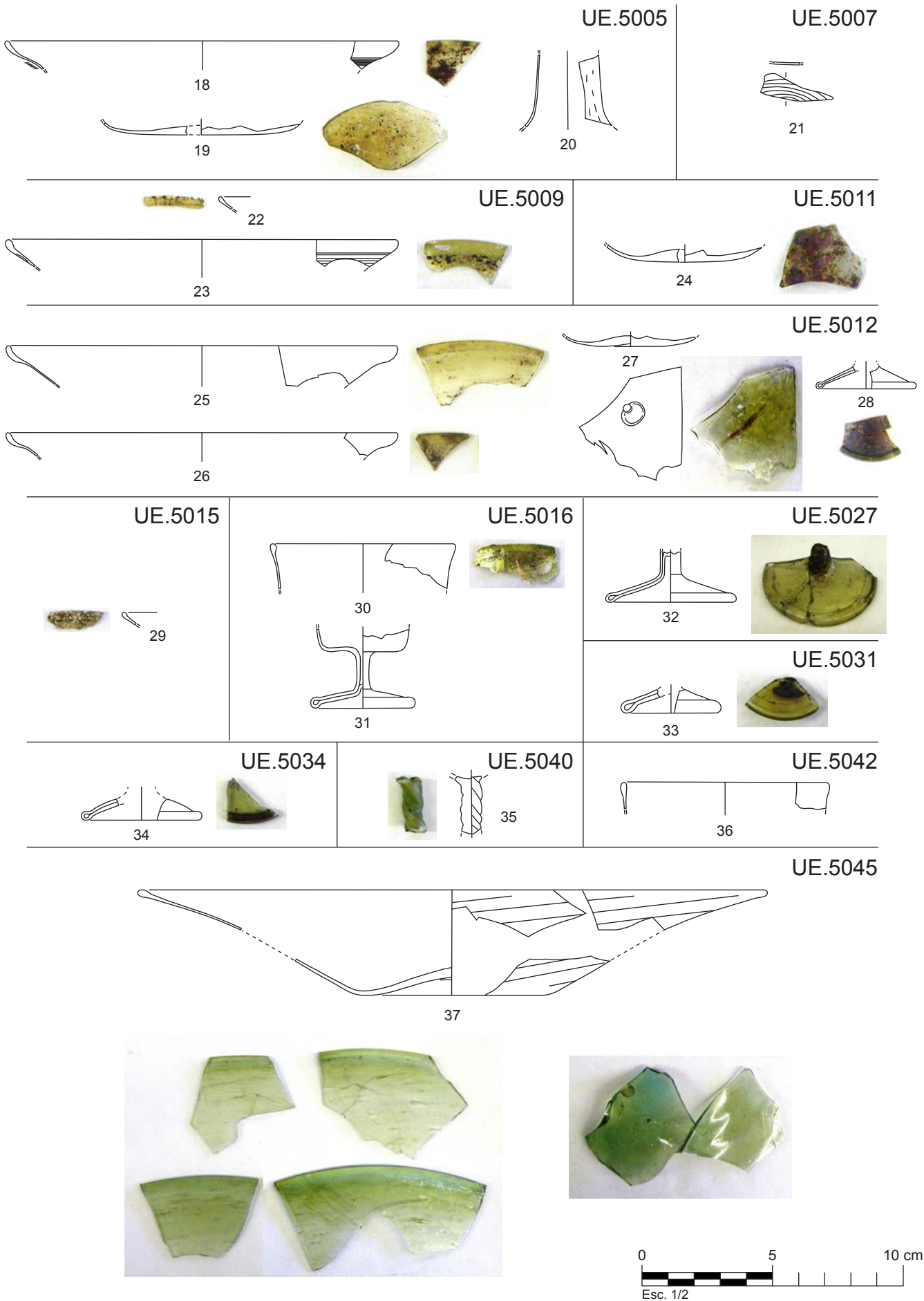

ÀMBIT 1 - UE.1140

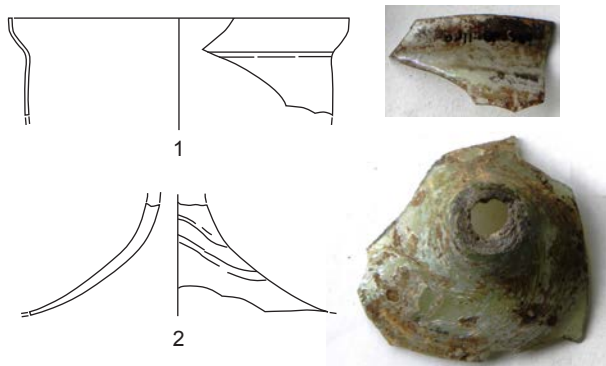

ÀMBIT 1 - UE.1143

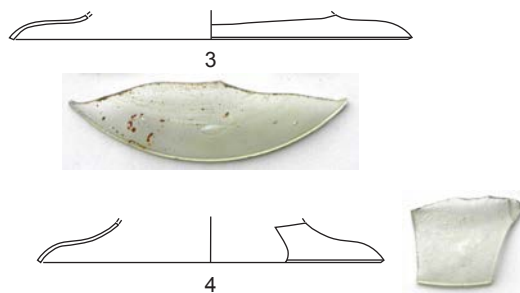

ÀMBIT 2 - UE.1050

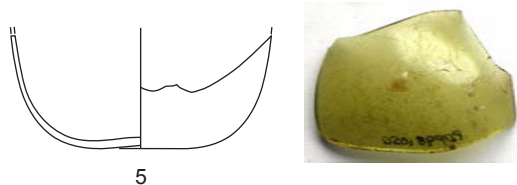

ÀMBIT 2 - UE.1139

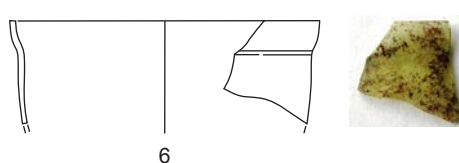

ÀMBIT 3 - UE.1010

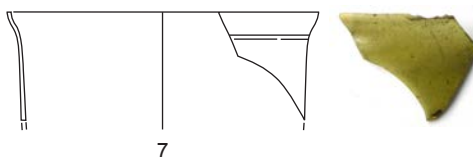

ÀMBIT 3 - UE.1012

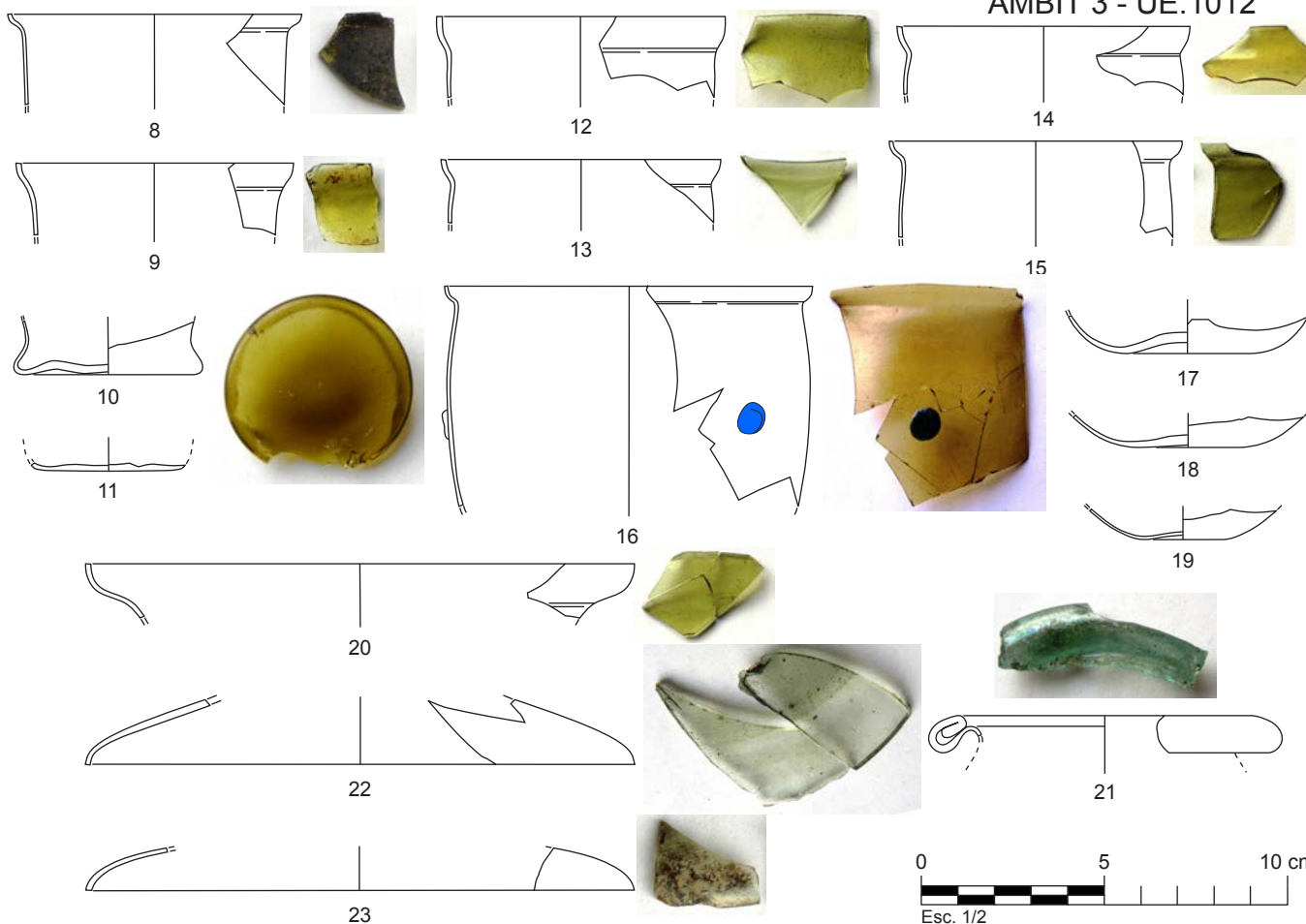

ÀMBIT 3 - UE.1019

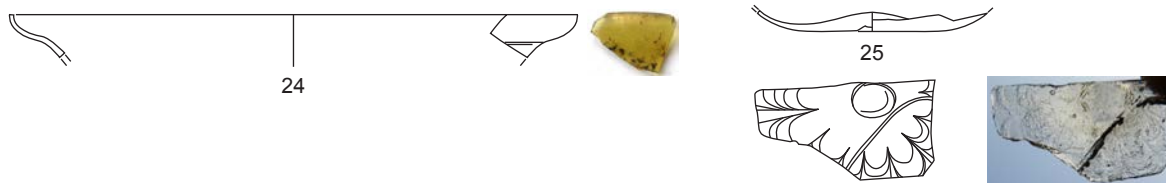

ÀMBIT 3 - UE.1020

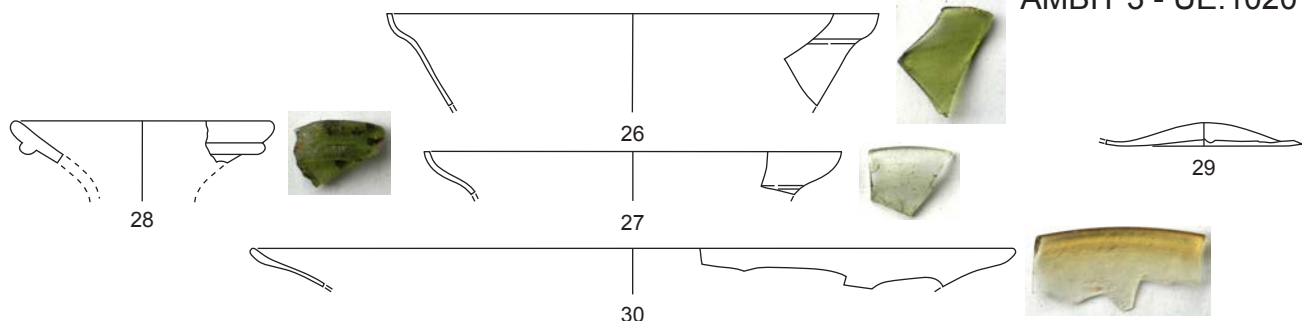

ÀMBIT 3 - UE.1021

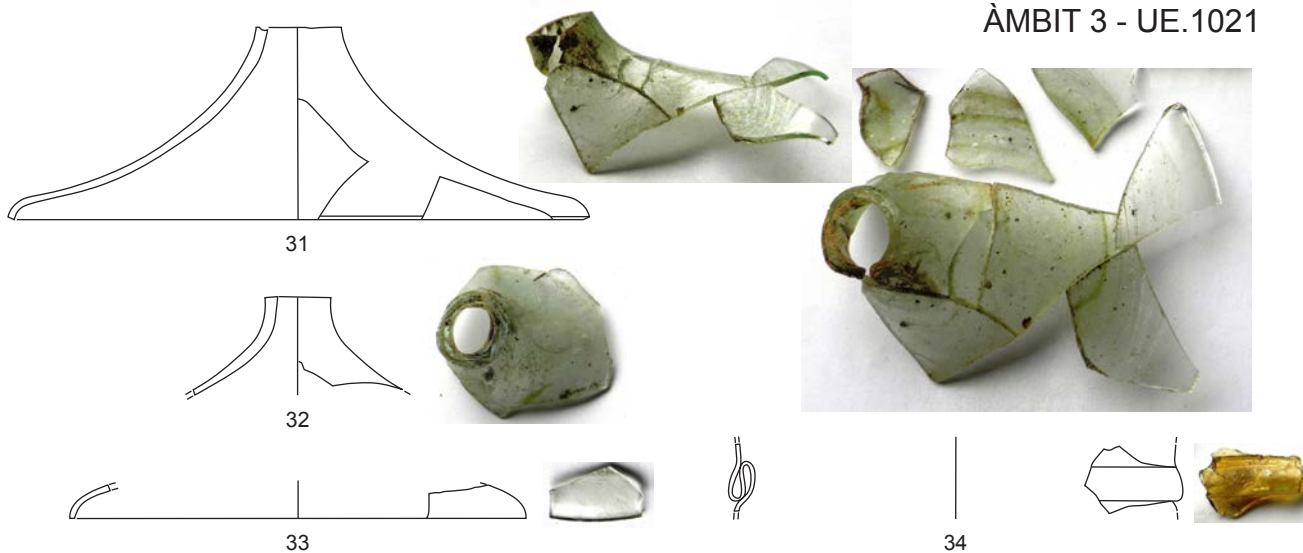

ÀMBIT 3 - UE.1034

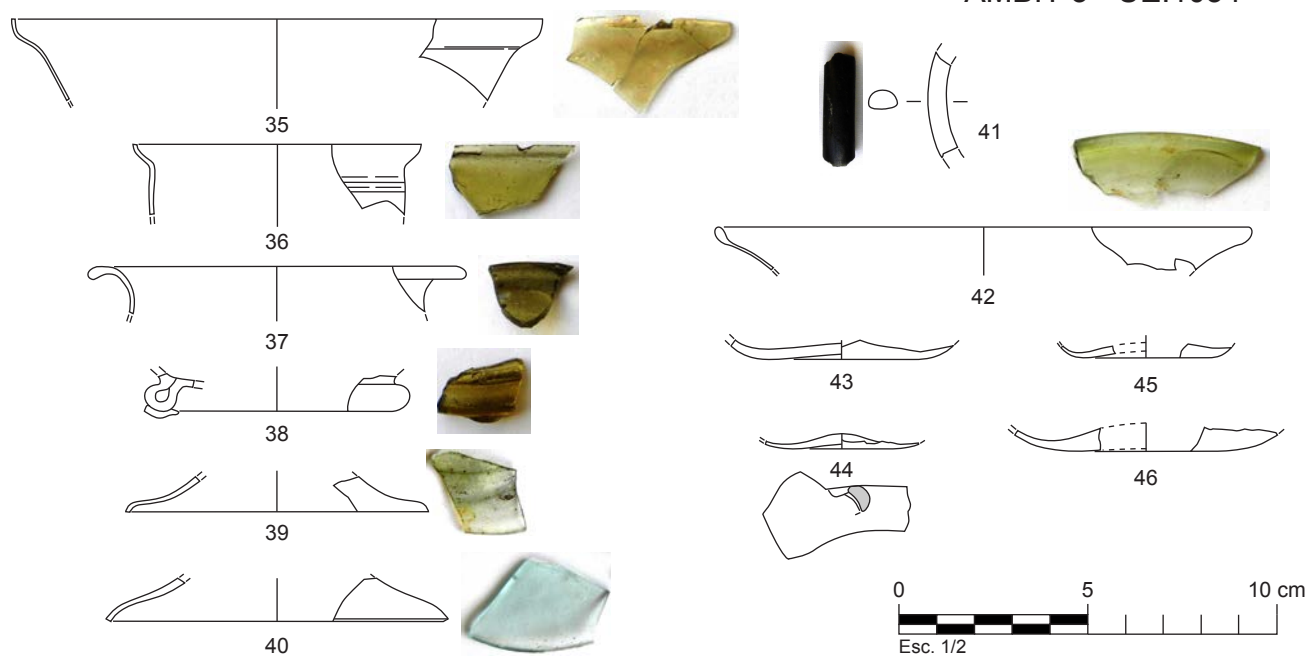

ÀMBIT 3 - UE.1041

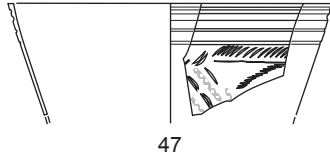
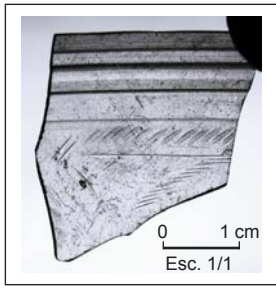

47

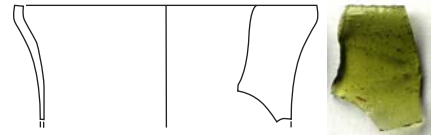

48

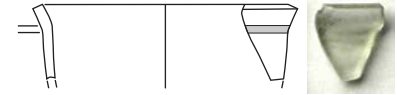

49

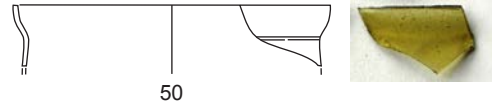

50



52

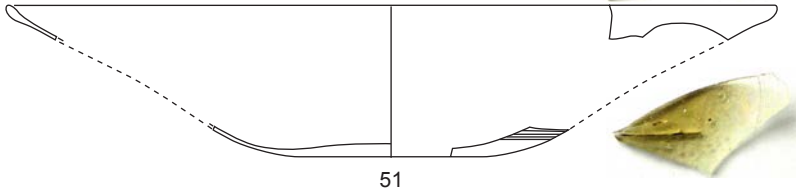

51

ÀMBIT 3 - UE.1042

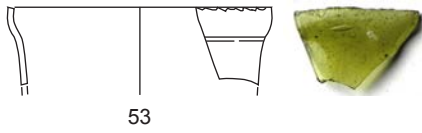

53

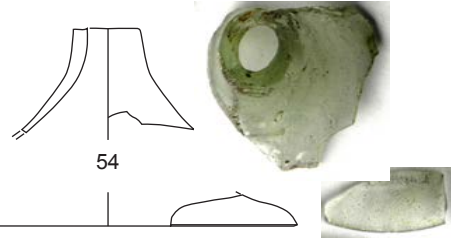

54



56



55

ÀMBIT 3 - UE.1043

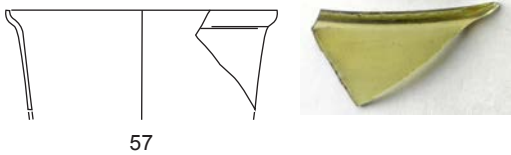

57

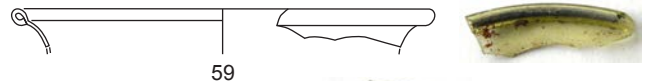

59

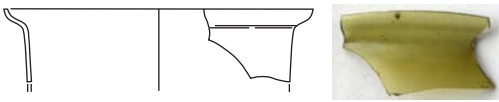

58

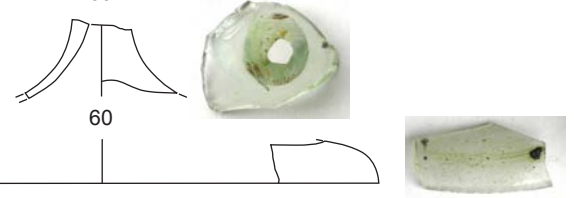

60



61

ÀMBIT 3 - UE.1065

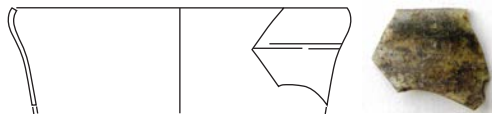

62



63

ÀMBIT 3 - UE.1077

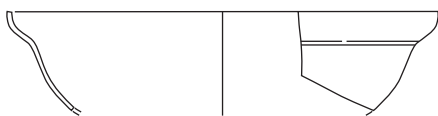

64

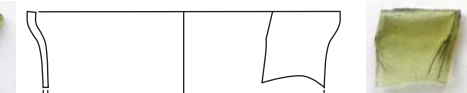

66

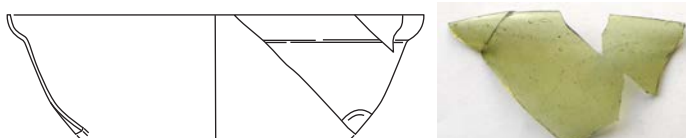

65

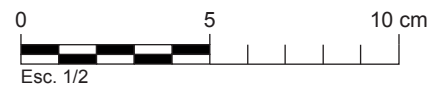

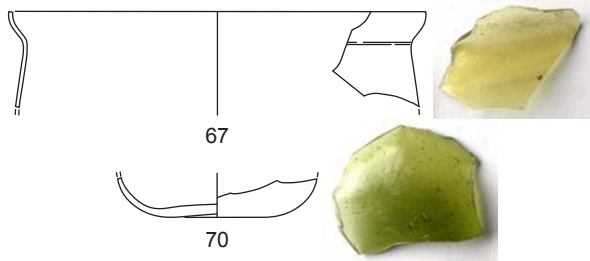

ÀMBIT 3 - UE.1082

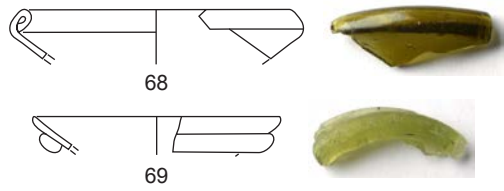

ÀMBIT 3 - UE.1084

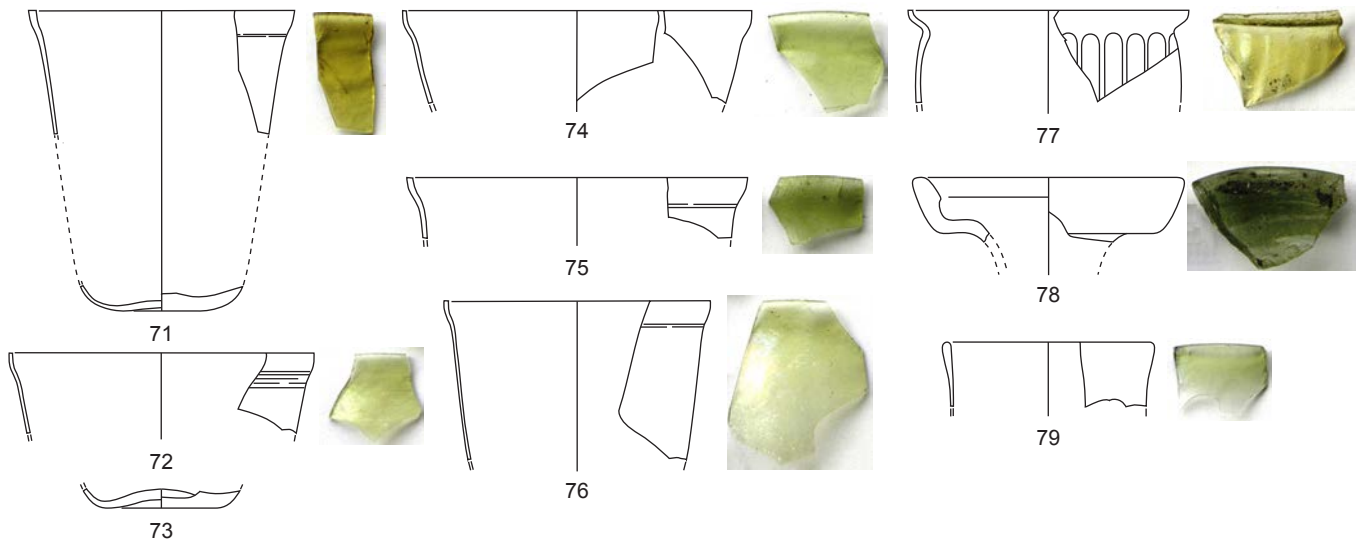

ÀMBIT 3 - UE.1088



ÀMBIT 3 - UE.1090



ÀMBIT 3 - UE.1091

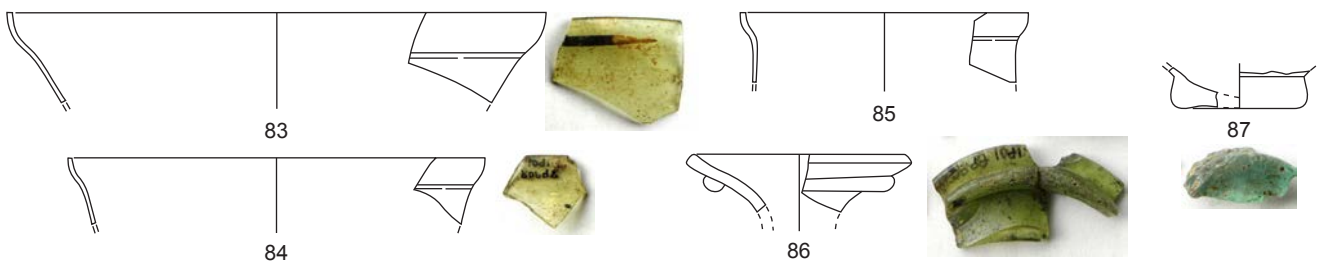

ÀMBIT 3 - UE.1108

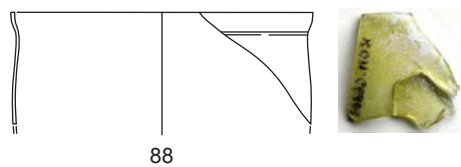

ÀMBIT 3 - UE.1115

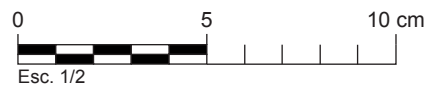

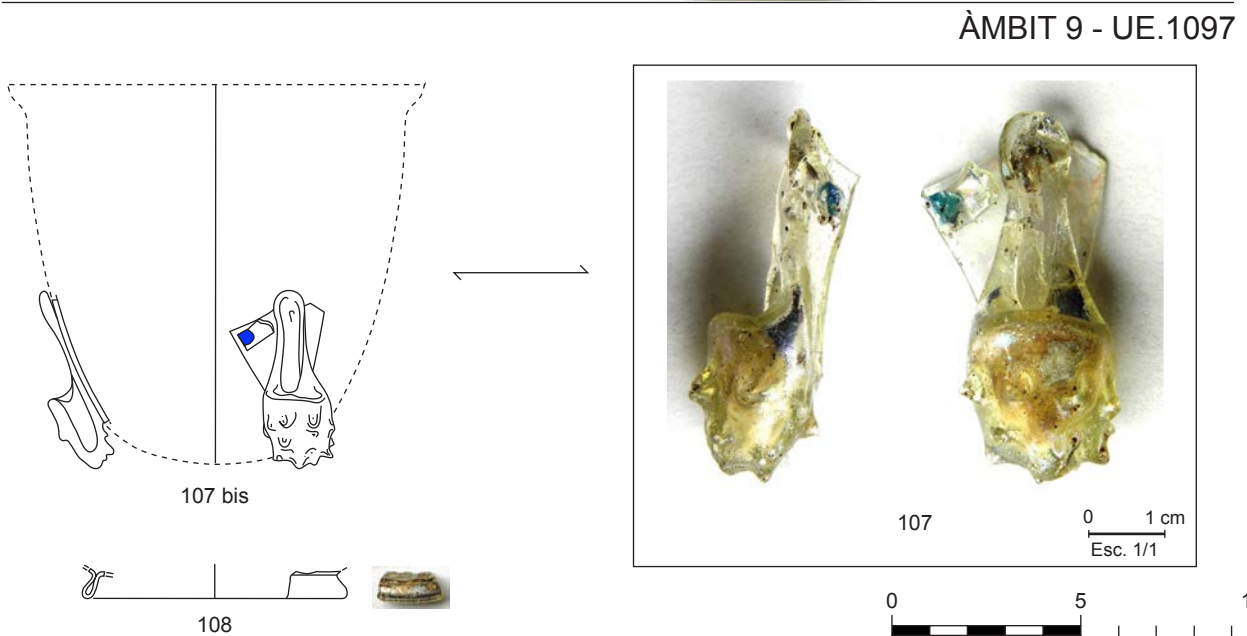
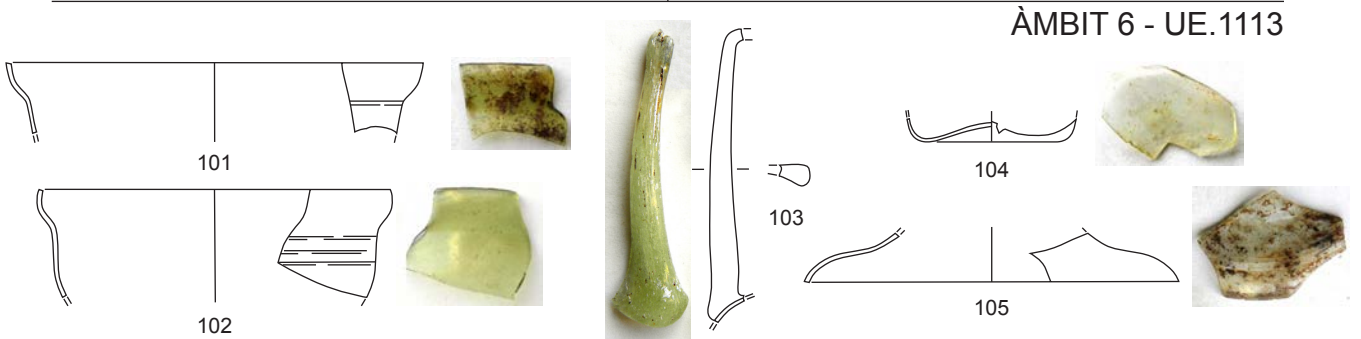
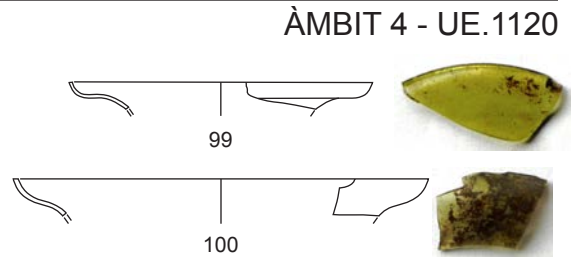
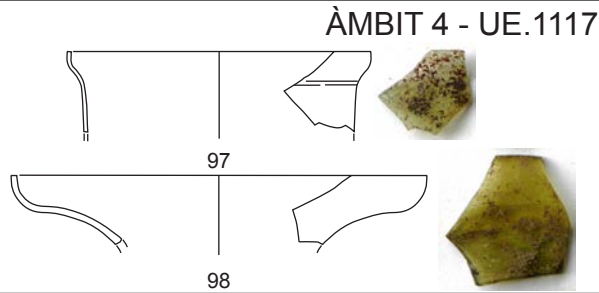
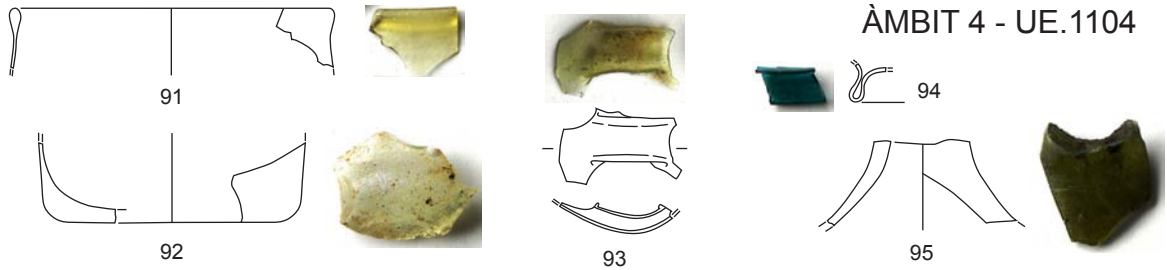



ÀMBIT 12 - UE.1159

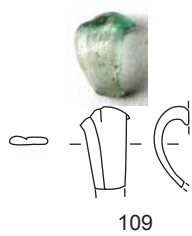

109

ÀMBIT 12 - UE.1163

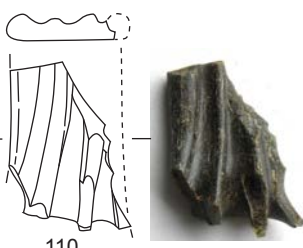

110

ÀMBIT 12 - UE.1169

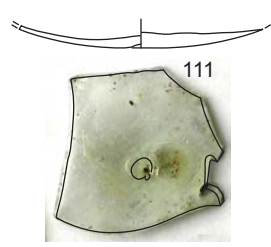

111

ÀMBIT 12 - UE.1182

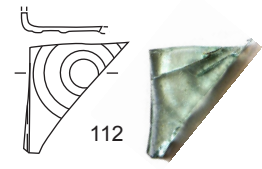

112

ÀMBIT 13 - UE.1009

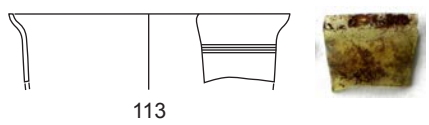

113

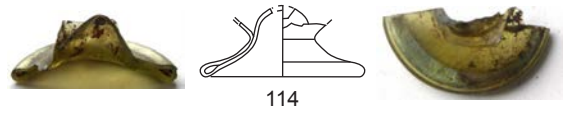

114

ÀMBIT 13 - UE.1024

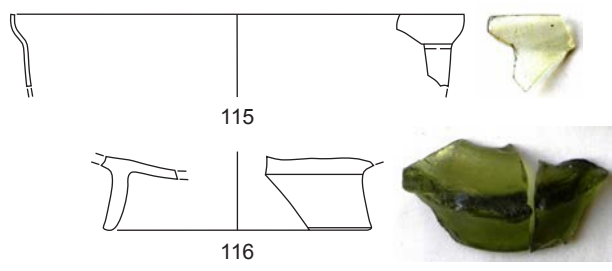

115

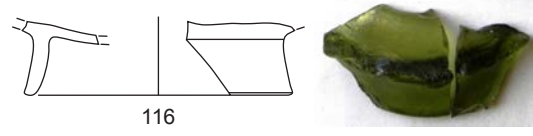

116

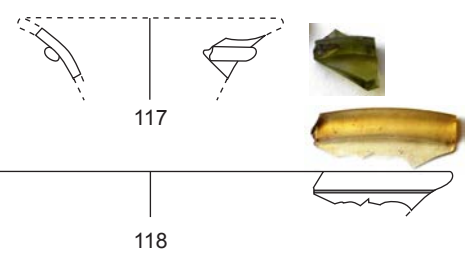

117



118

ÀMBIT 13 - UE.1033

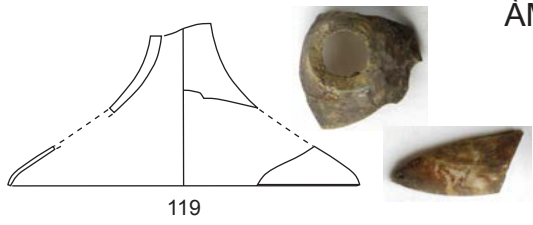

119

ÀMBIT 14 - UE.1037

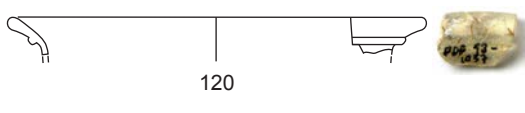

120

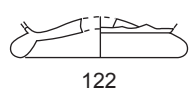

122

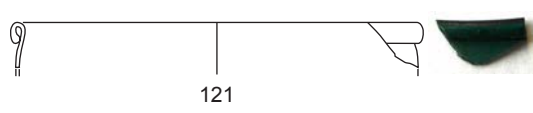

121



123



124

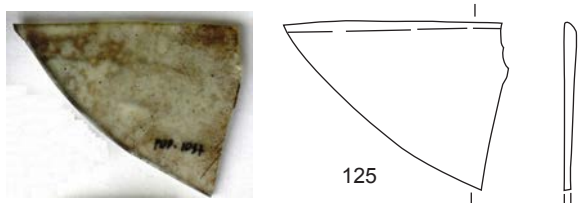

125

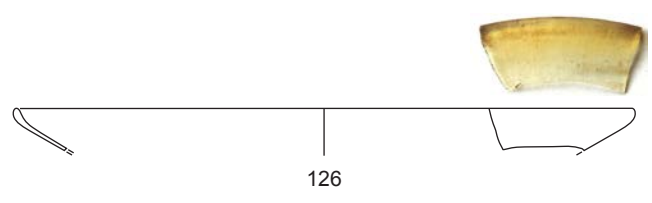

126

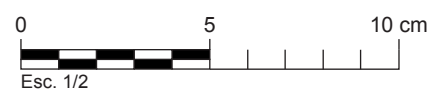

Esc. 1/2

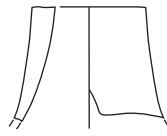

ÀMBIT 15 - UE.1023

127

ÀMBIT 15 - UE.1031

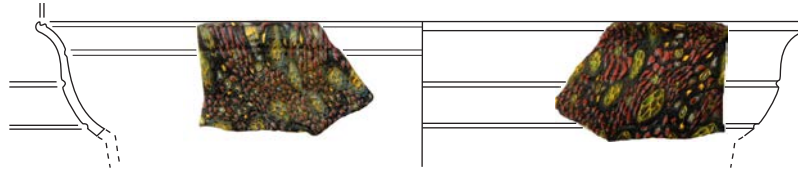

128

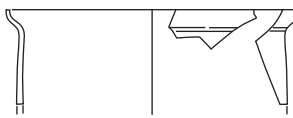

129

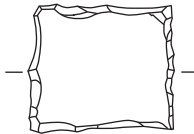

131

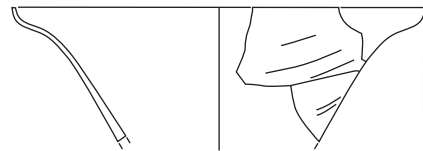

132

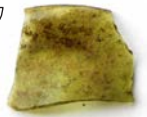

130

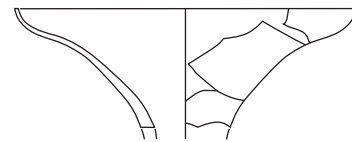

133



ÀMBIT 15 - UE.1036

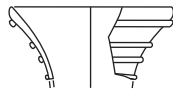

134



135



ÀMBIT 15 - UE.1038

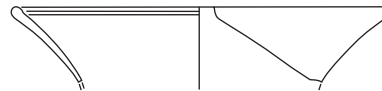

136



137



ÀMBIT 16 - UE.1184



138

ÀMBIT 17 - UE.1002



139



ÀMBIT 17 - UE.1007

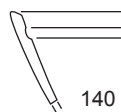
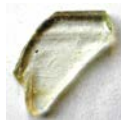

140

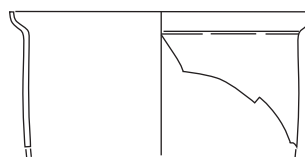

141



ÀMBIT 18 - UE.1186

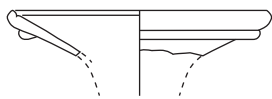

142



ÀMBIT 18 - UE.1194



143

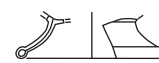

144

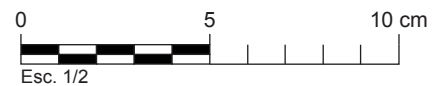

Esc. 1/2

ÀMBIT 19/20 - UE.1200

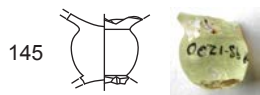

ÀMBIT 23 - UE.1228

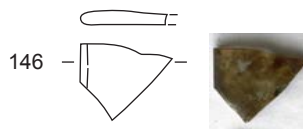

ÀMBIT 24 - UE.1253

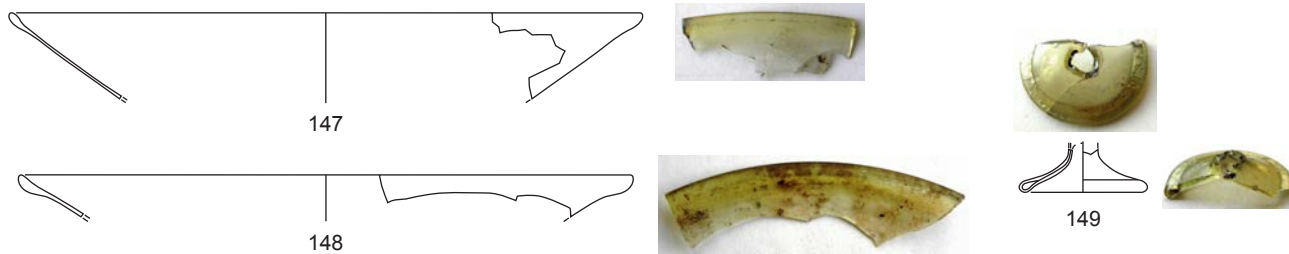

ÀMBIT 24 - UE.1255



ÀMBIT 25 - UE.1361

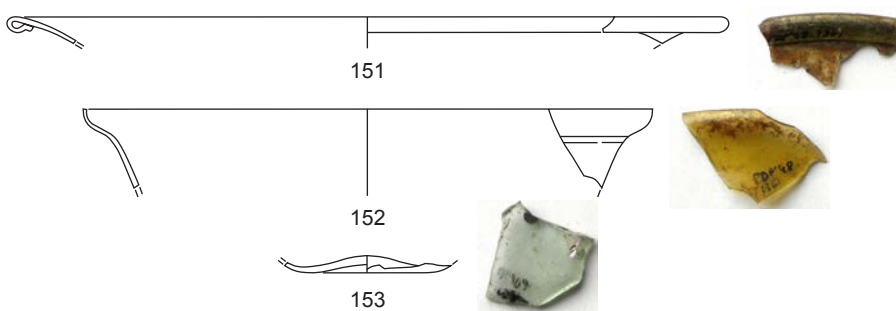

ÀMBIT 25bis - UE.1265

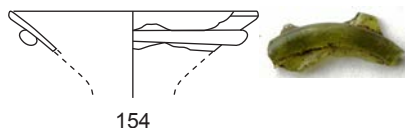

ÀMBIT 25bis - UE.1269

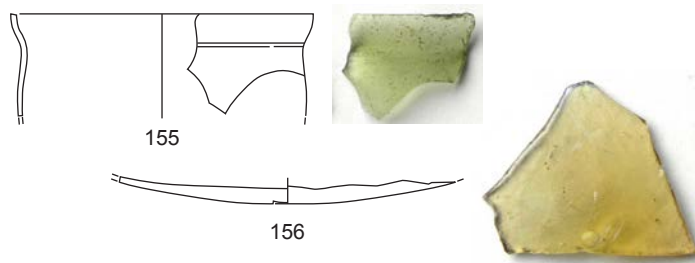

ÀMBIT 25bis - UE.1270

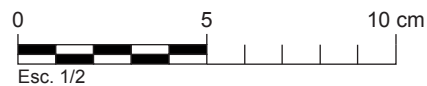
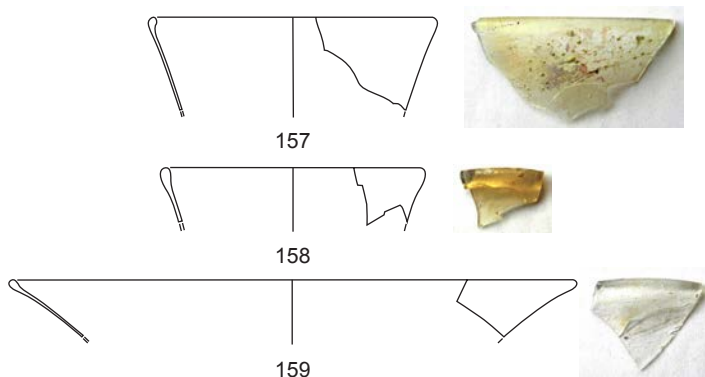

ÀMBIT 26 - UE.1266

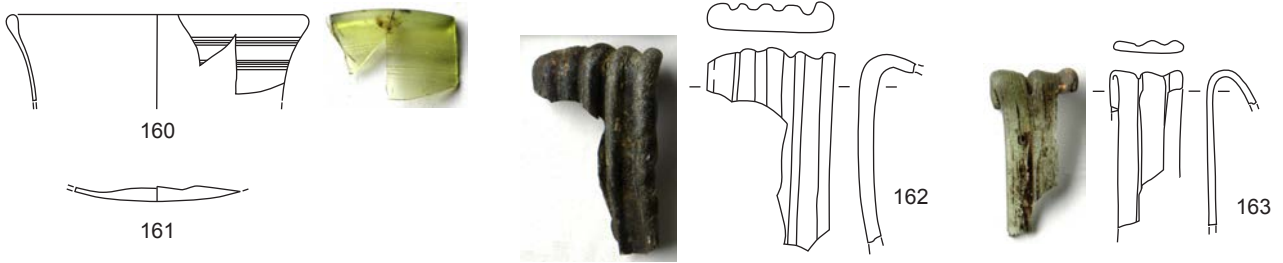

ÀMBIT 26 - UE.1272

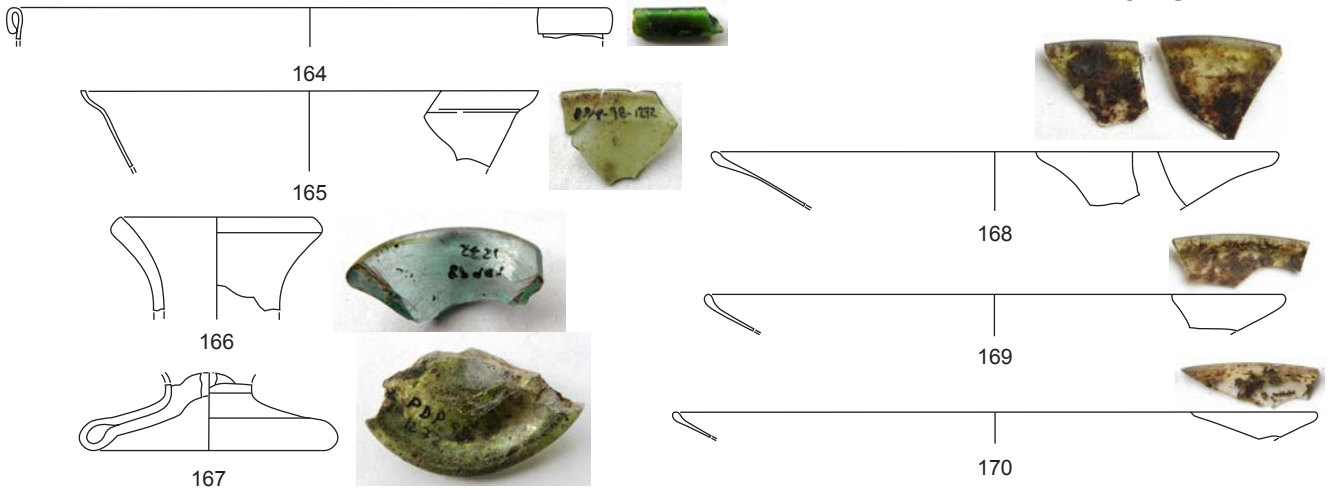

ÀMBIT 26 - UE.1276

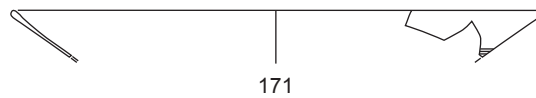

ÀMBIT 26 - UE.1277

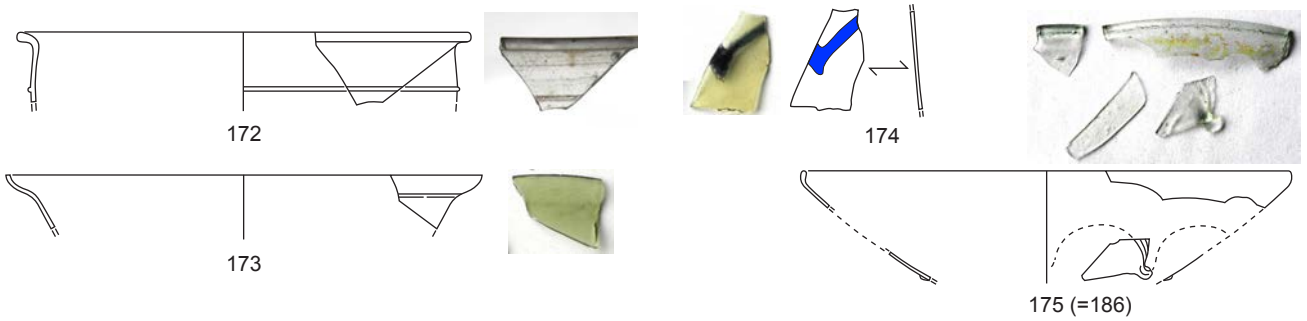

ÀMBIT 26 - UE.1295

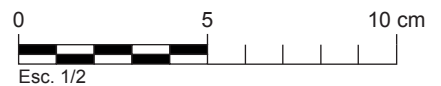
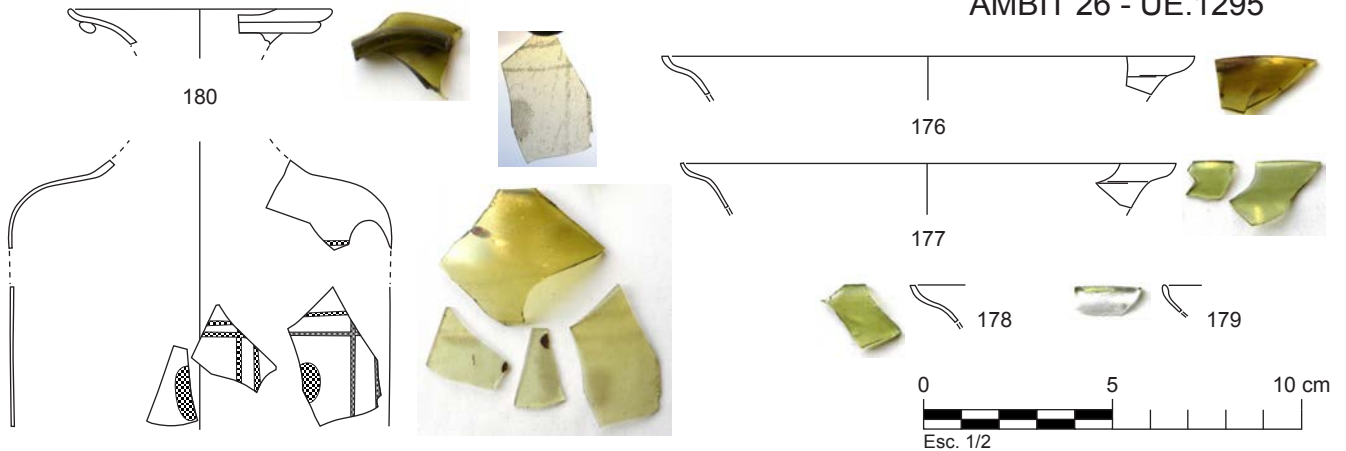

ÀMBIT 26 - UE.1299

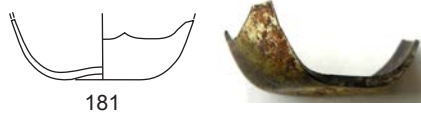

181

ÀMBIT 26 - UE.1302

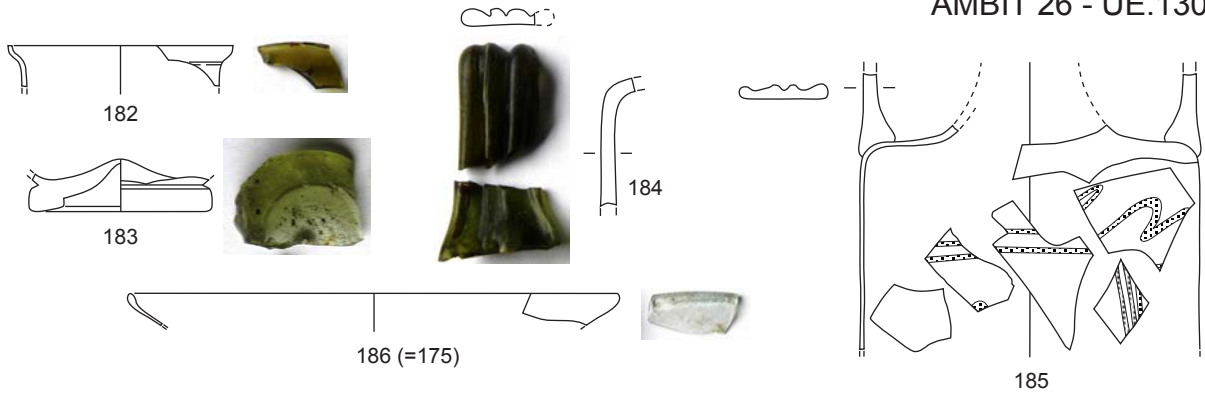

182

183

184

185

186 (=175)

ÀMBIT 26 - UE.1306

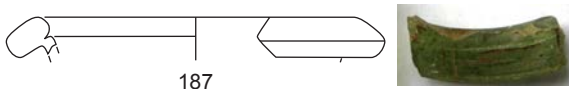

187

ÀMBIT 26 - UE.1316



188

ÀMBIT 27 - UE.1292

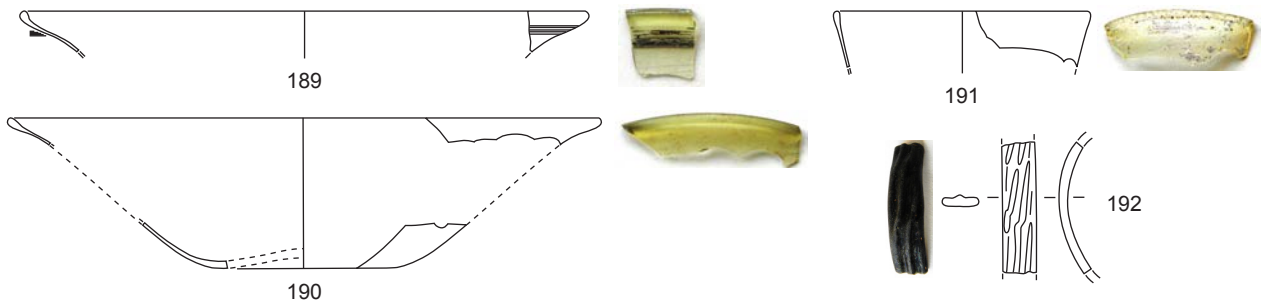

189

190

191

192

ÀMBIT 27 - UE.1304



193

ÀMBIT 27 - UE.1326

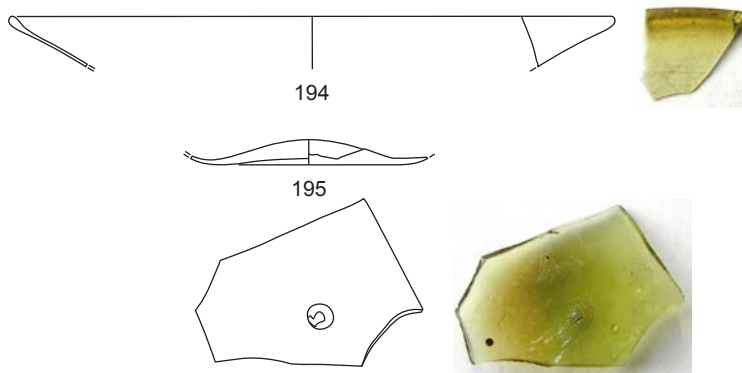

194

195

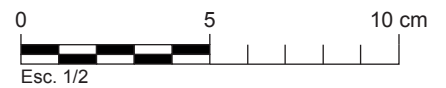

ÀMBIT 28 - UE.1313

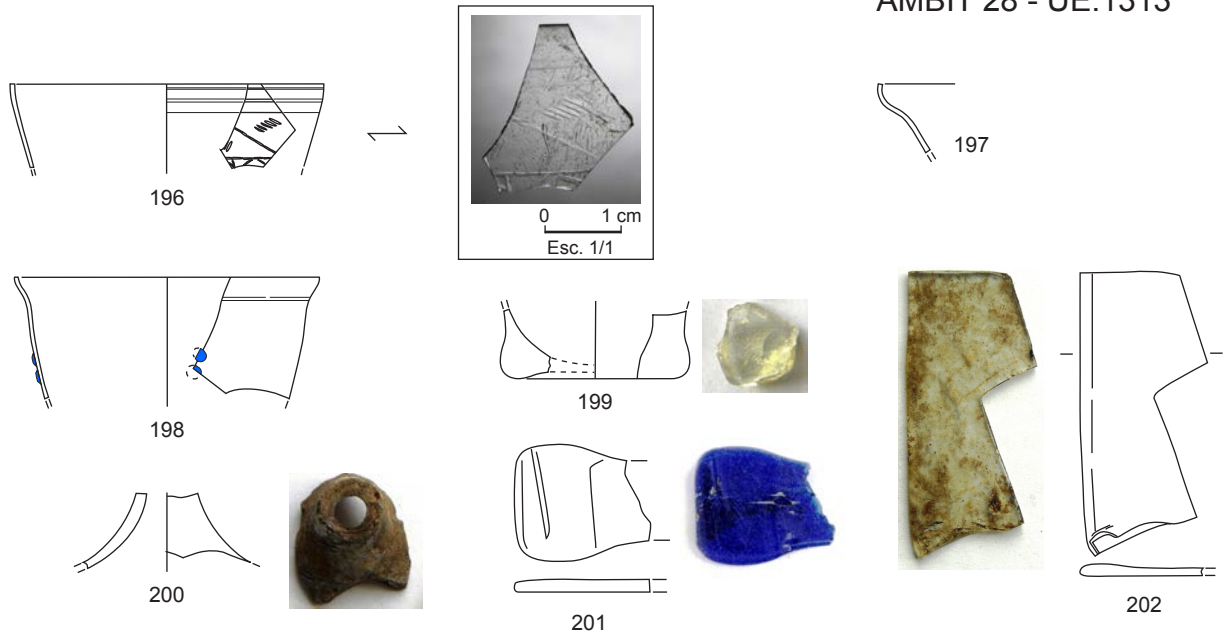

ÀMBIT 28 - UE.1329



ÀMBIT 28 - UE.1368

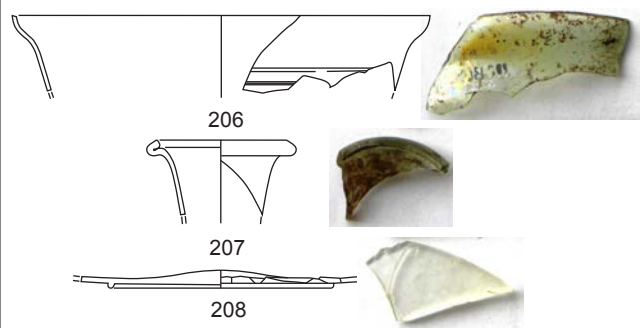

ÀMBIT 30 - UE.1297

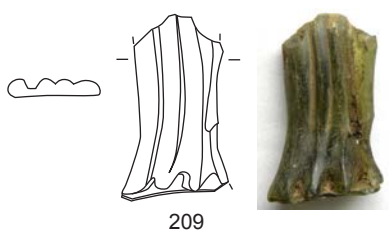

ÀMBIT 30 - UE.1339

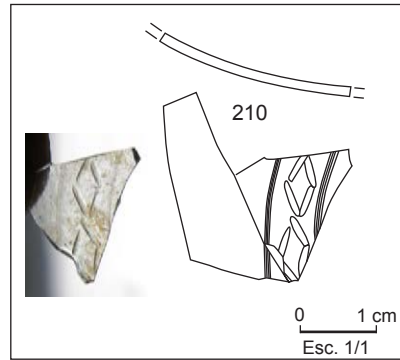

ÀMBIT 30 - UE.1353



ÀMBIT 31 - UE.1383

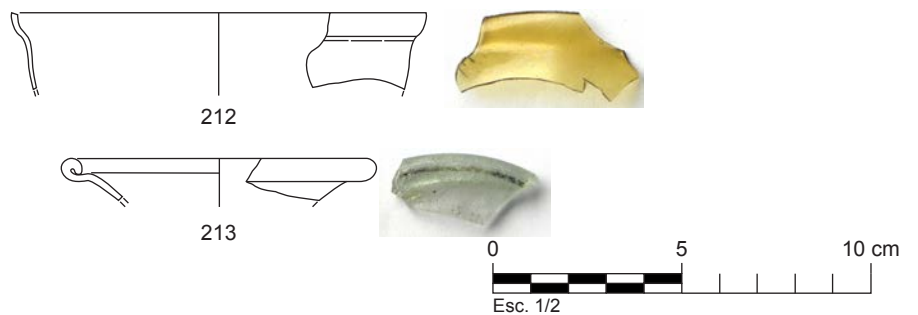

ÀMBIT 32 - Ues.1380-1383

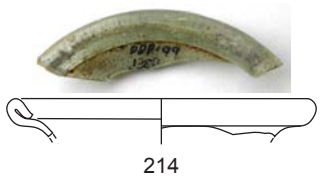

ÀMBIT 32 - UE.1384

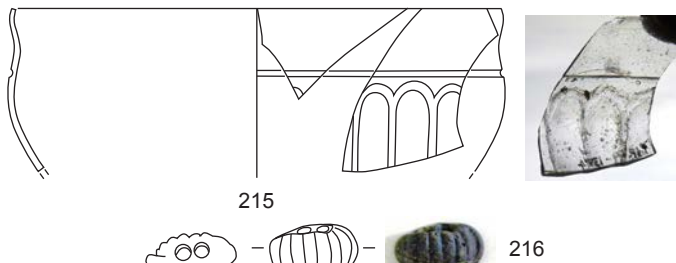

ÀMBIT 32 - UE.1403

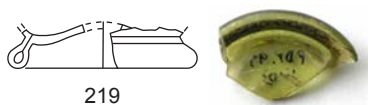

ÀMBIT 32 - Ues. 1394 i 1395

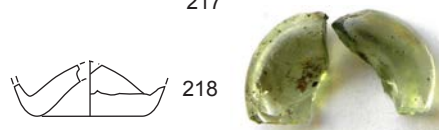
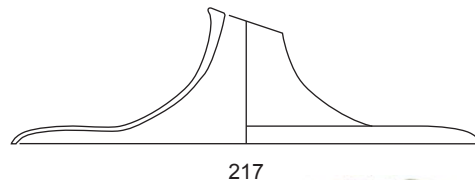

ÀMBIT 32 - UE.1410

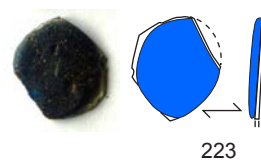
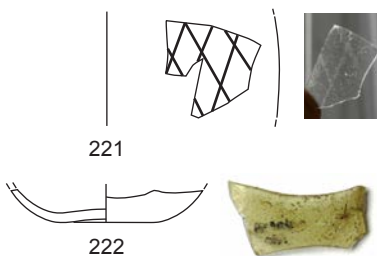
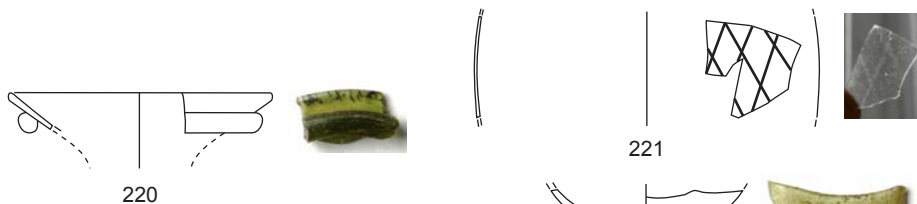

ÀMBIT 32 - UE.1425

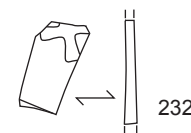
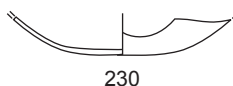
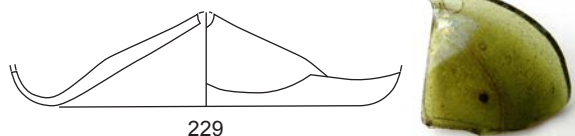
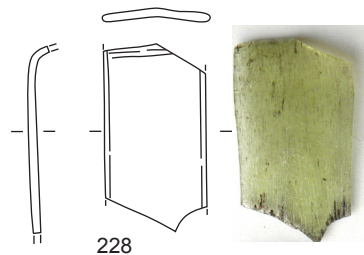
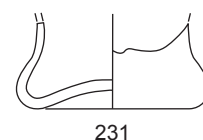
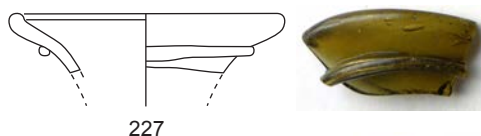
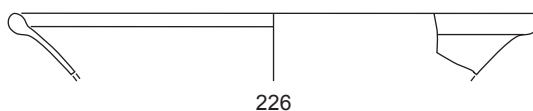

ÀMBIT 32 - UE.1451

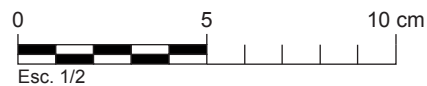
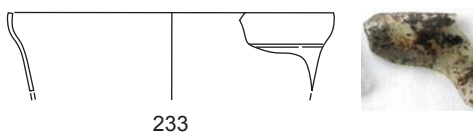

ÀMBIT 33 - UE.1381

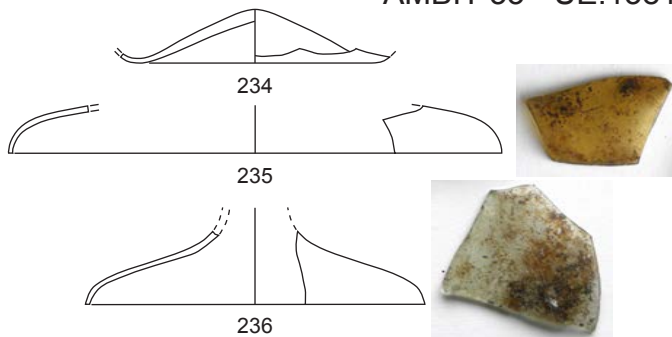

ÀMBIT 33 - UE.1395

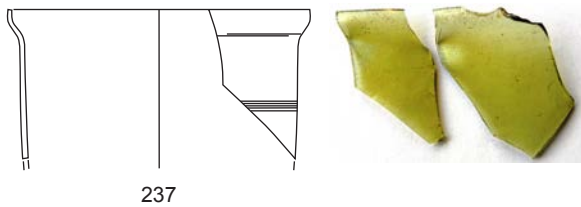

ÀMBIT 34 - UE.1397

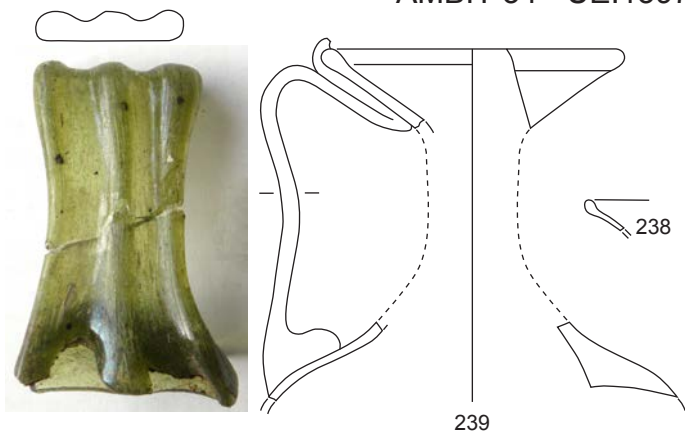

ÀMBIT 34 - UE.1440

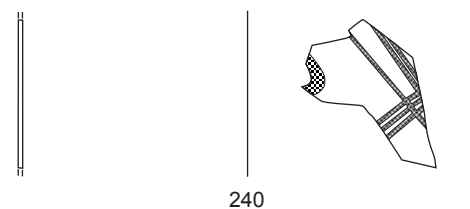

ÀMBIT 35 - UE.1420



ÀMBITS 35/38 - UE.1375

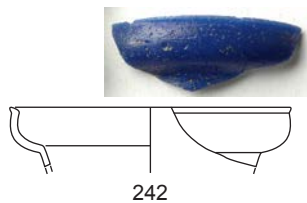

ÀMBITS 35/38 - UE.1416

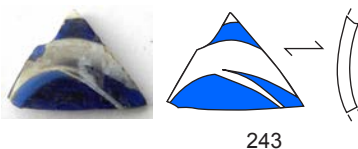

ÀMBITS 35/38 - UE.1475



UE.1000

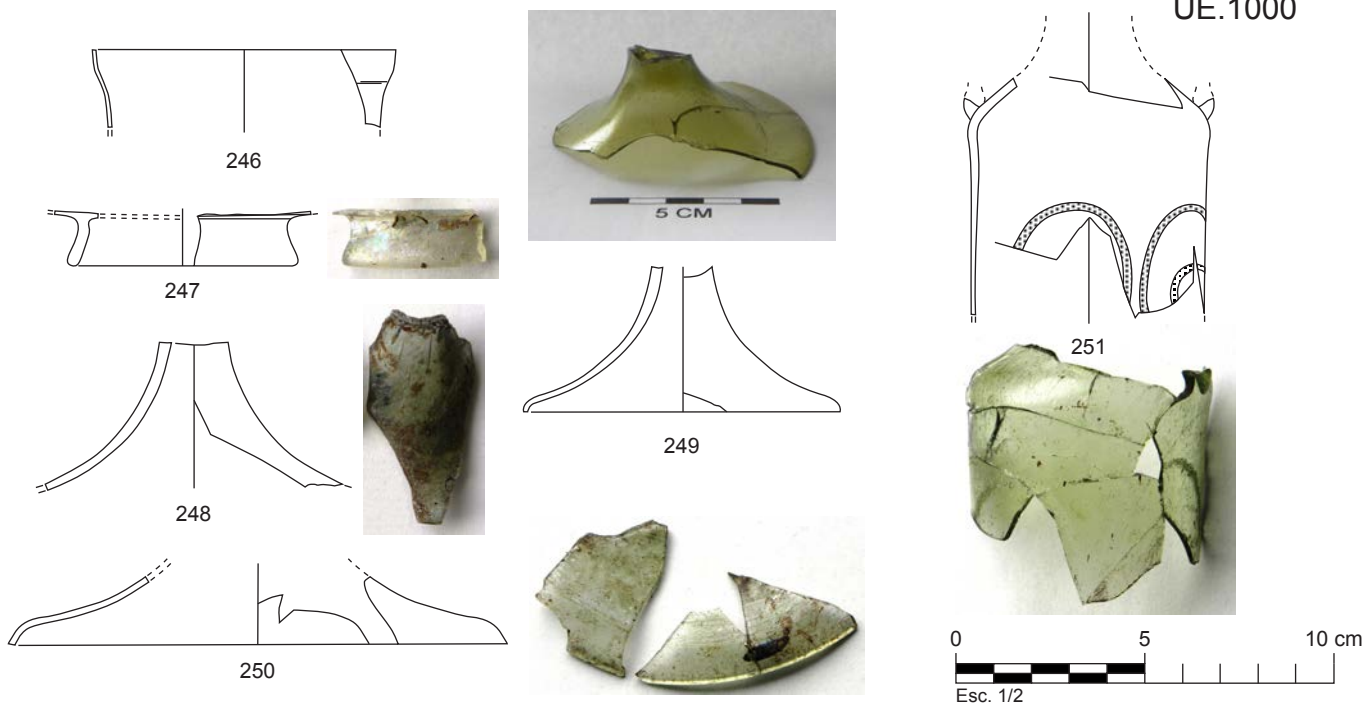



UE.2001

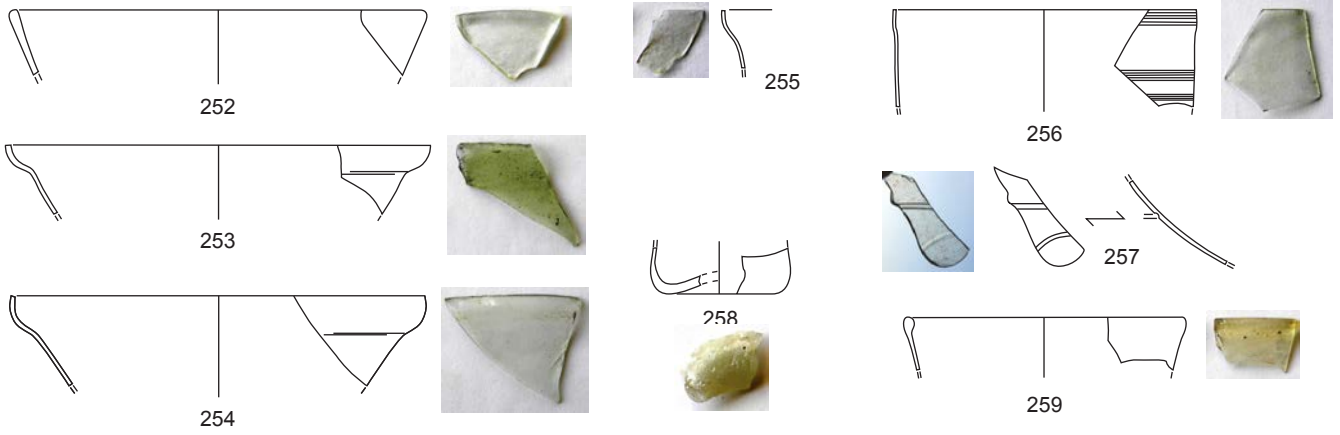

UE.2002

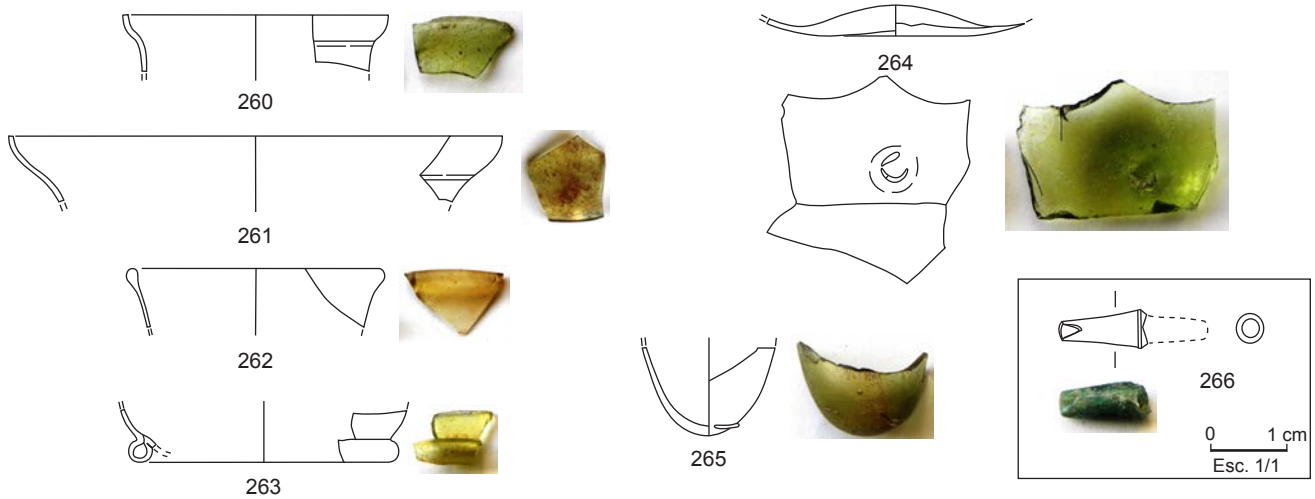

UE.2013



Nuclis de vidre en brut / fragments de lingot



UE.1310  
271



UE.1277  
270



UE.1031  
269

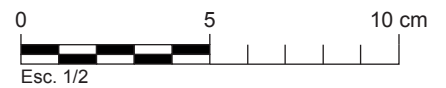

Raset de Baix (Cervià de Ter)

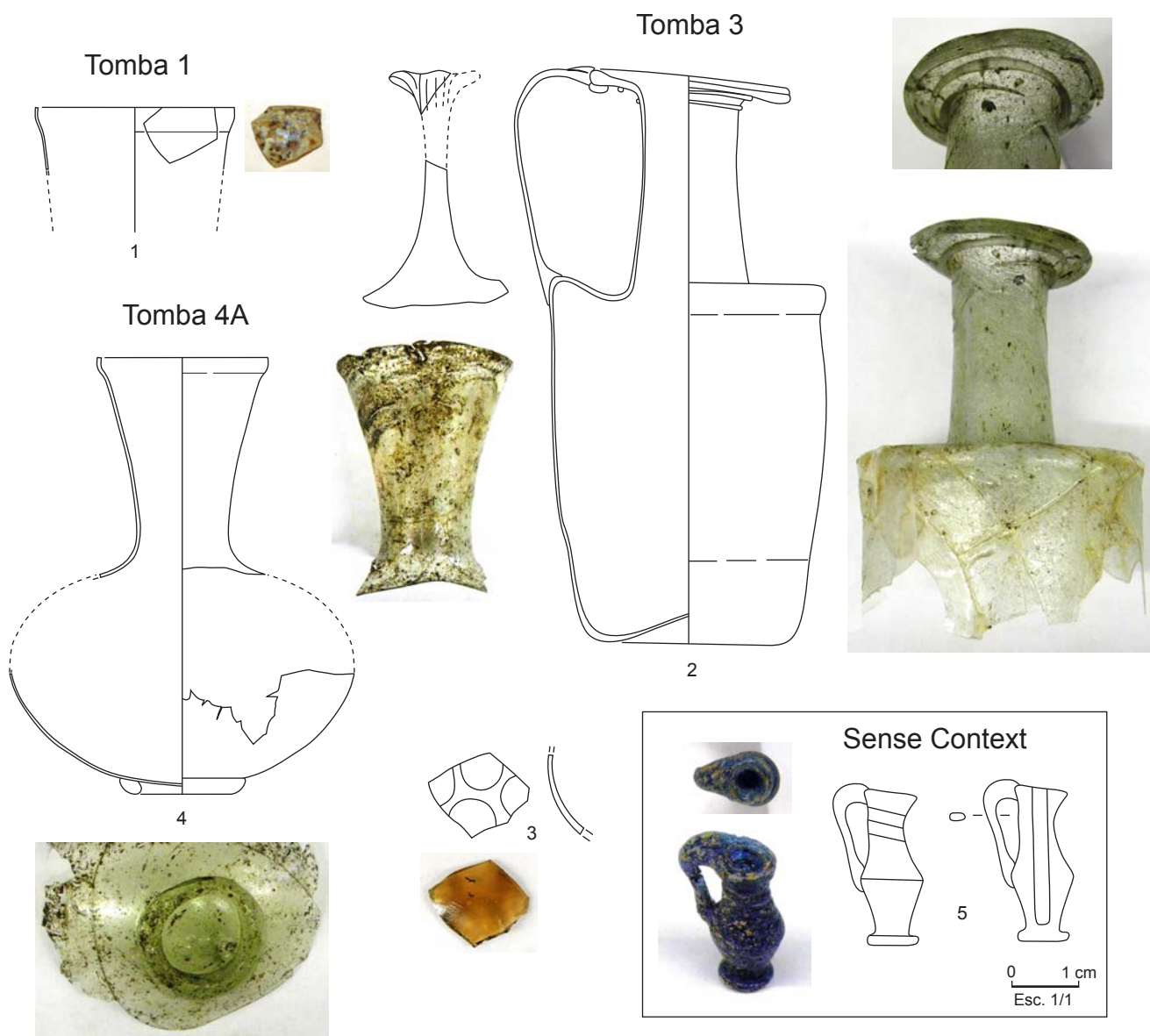

Pla de l'Horta (Sarrià de Ter)



Fotografia de la fíbula extreta de NOLLA-PALAHÍ-PRAT 2018

Enterrament.17

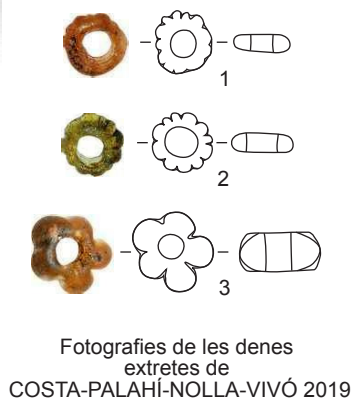

Enterrament.54

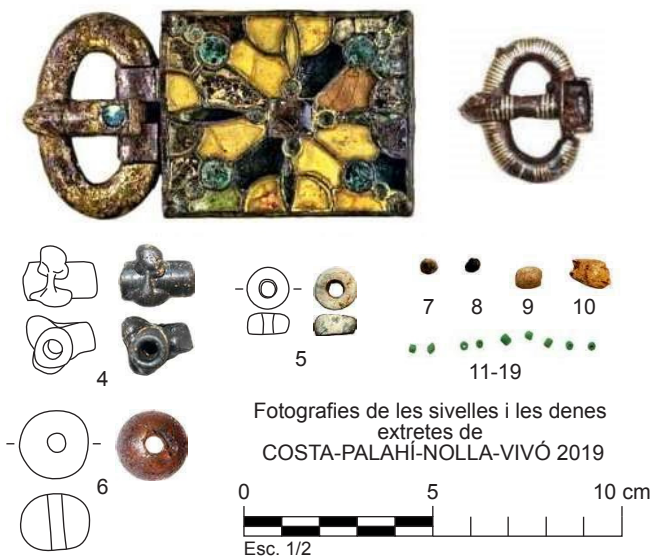

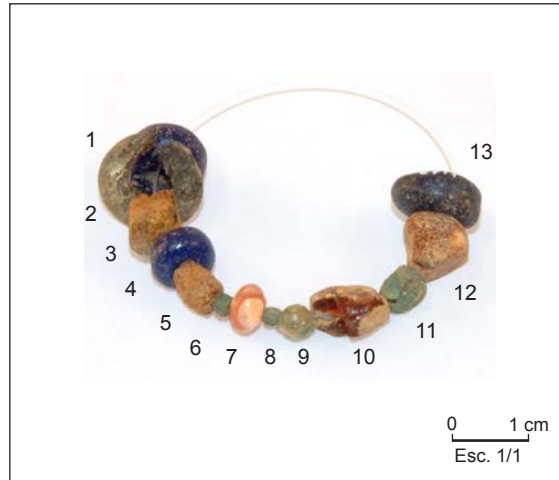

Fotografia de MAC-Girona. Nº41239  
©Arxiu d'imatges, fons Museu d'Arqueologia  
de Catalunya - Girona

El Castellum (Sant Julià de Ramis)

UE.1001

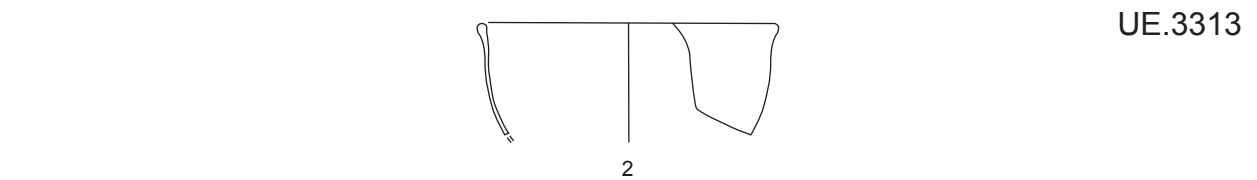
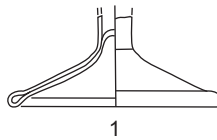

UE.3313



UE.3301

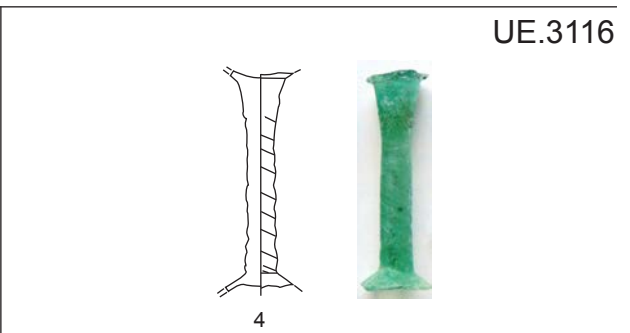

UE.3116

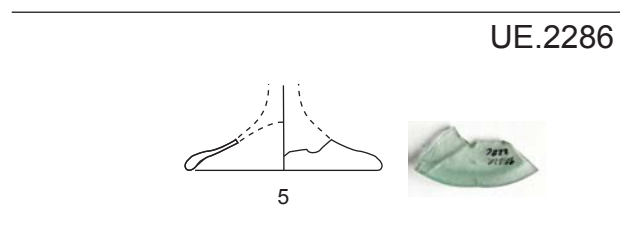

UE.2286

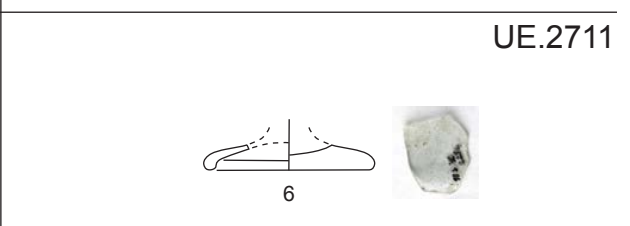

UE.2711

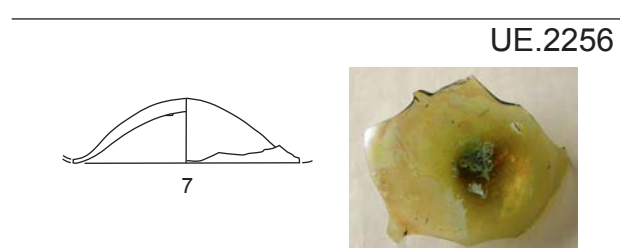

UE.2256

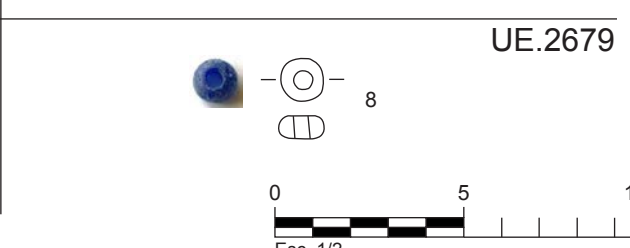

UE.2679

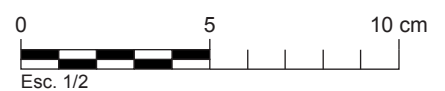

Altimperi (S.I)

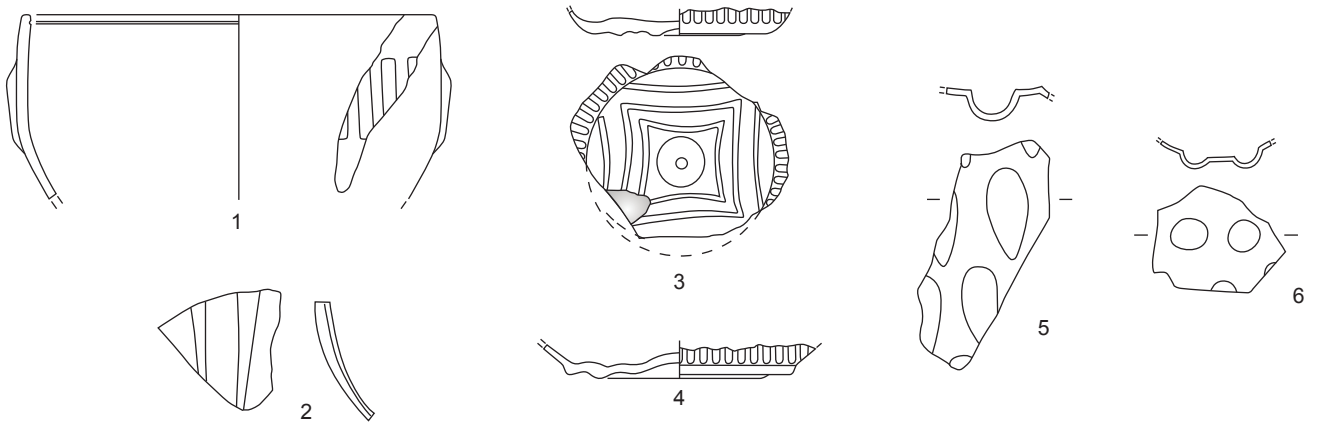

Altimperi (s.II-III)

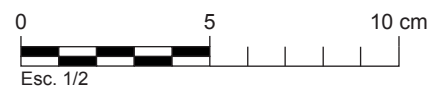
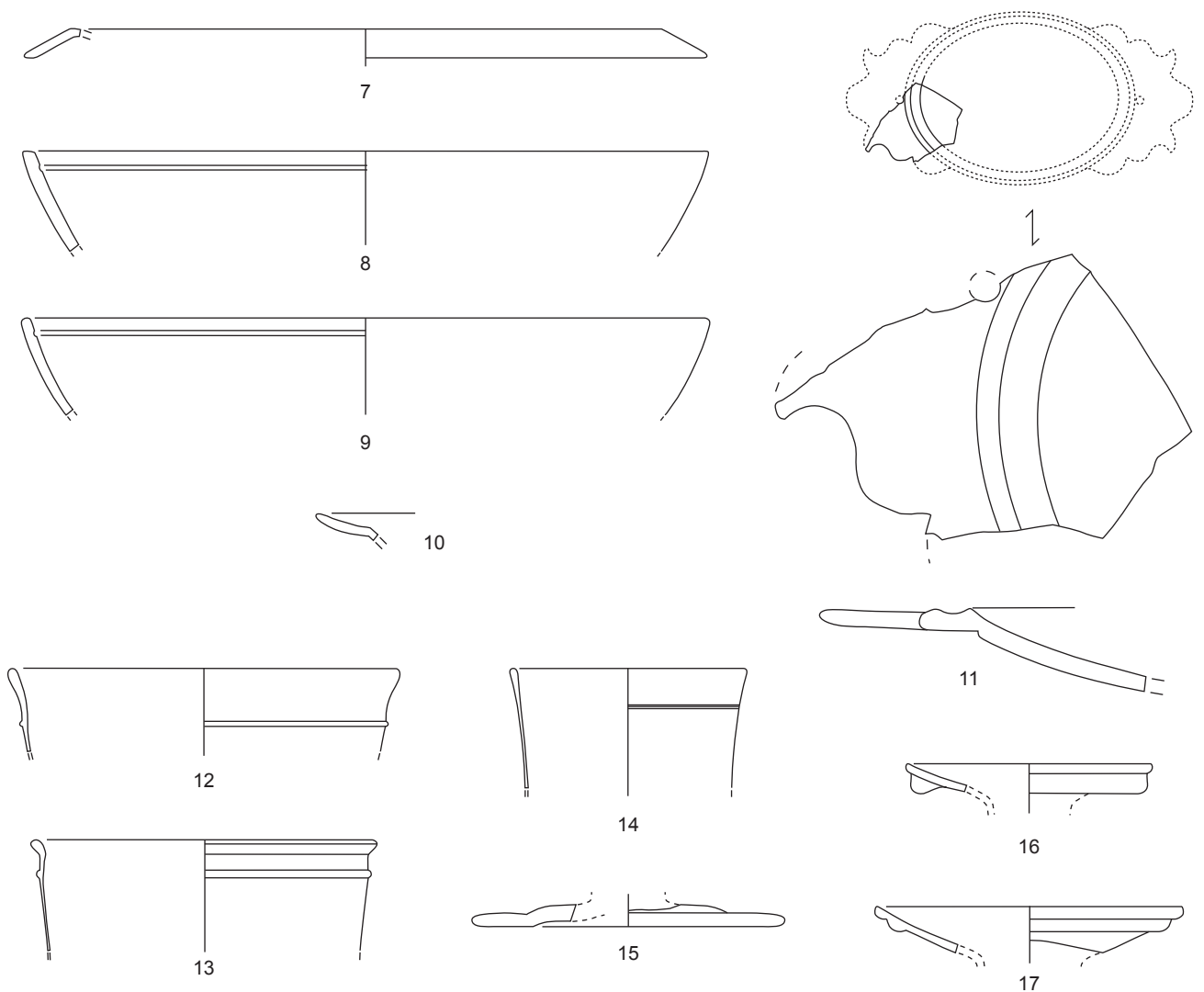

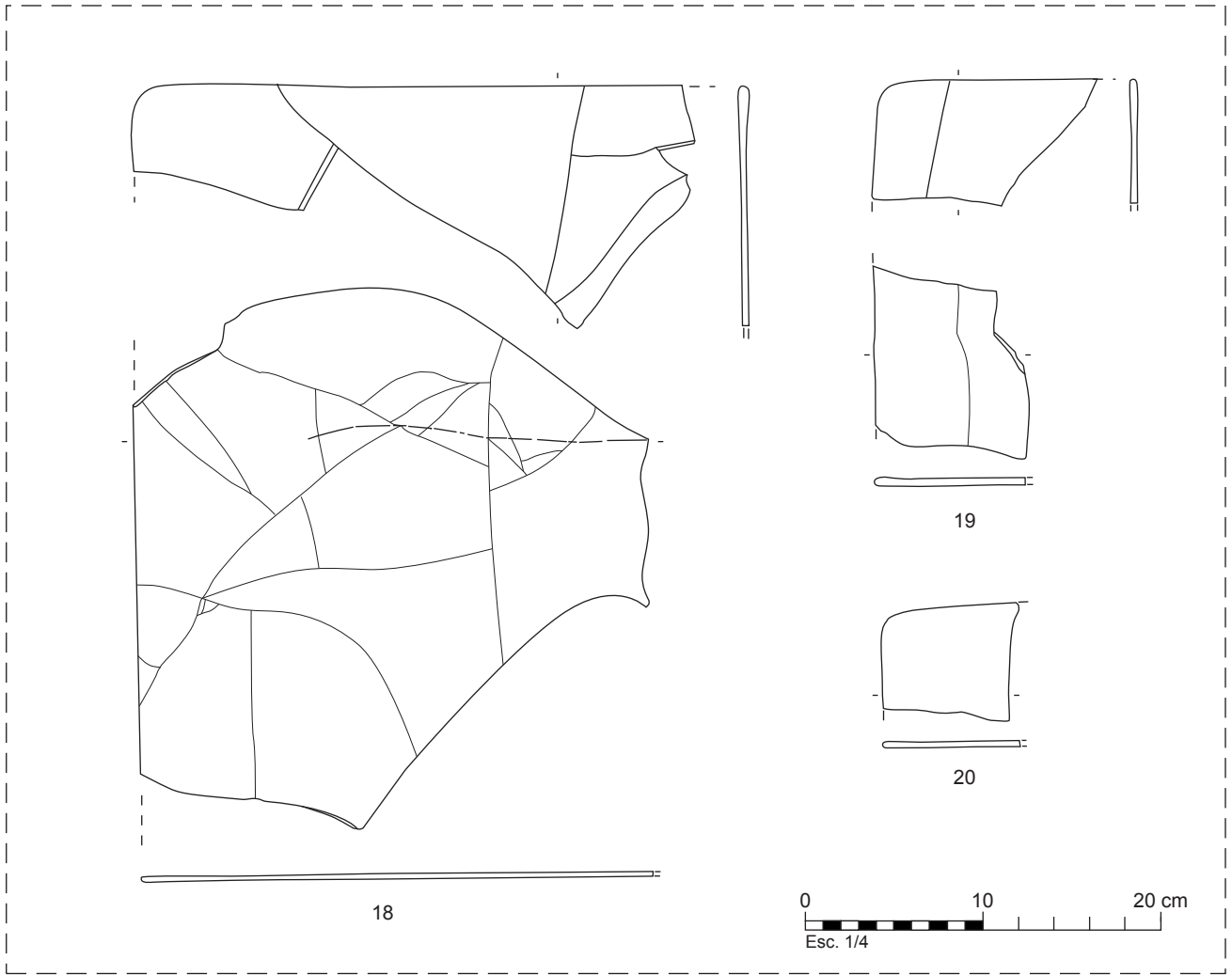

Segle III (c. 270 AD)

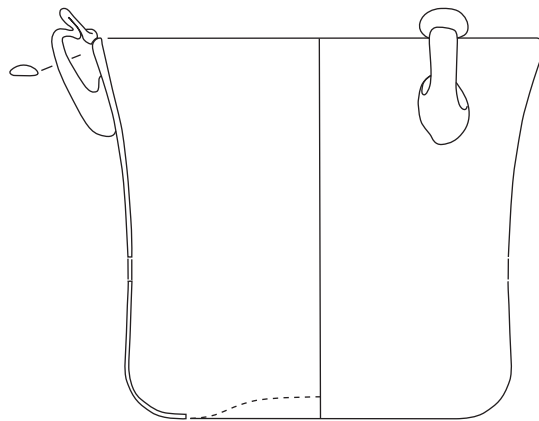

Època Visigoda (s.VI-VII)

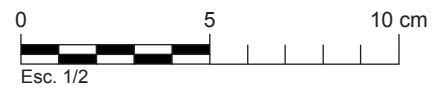
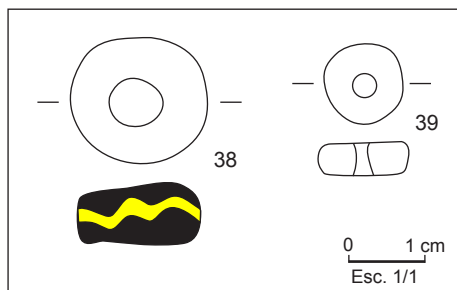
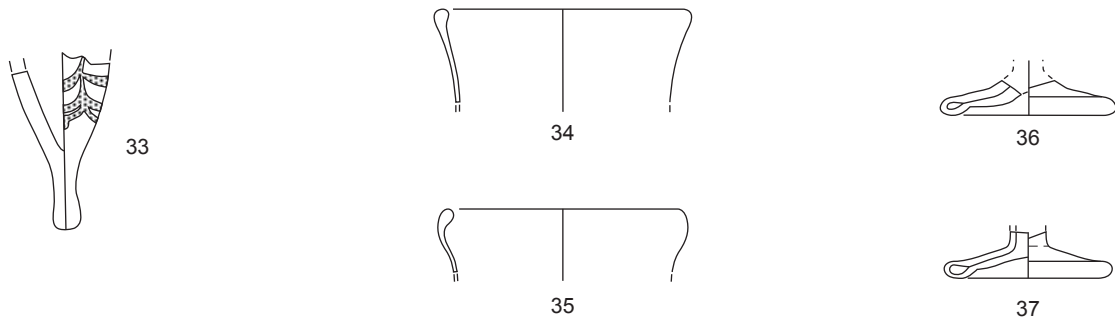
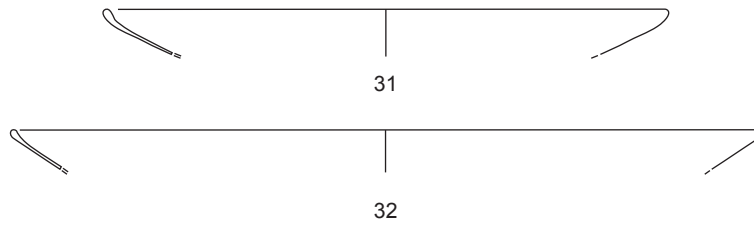
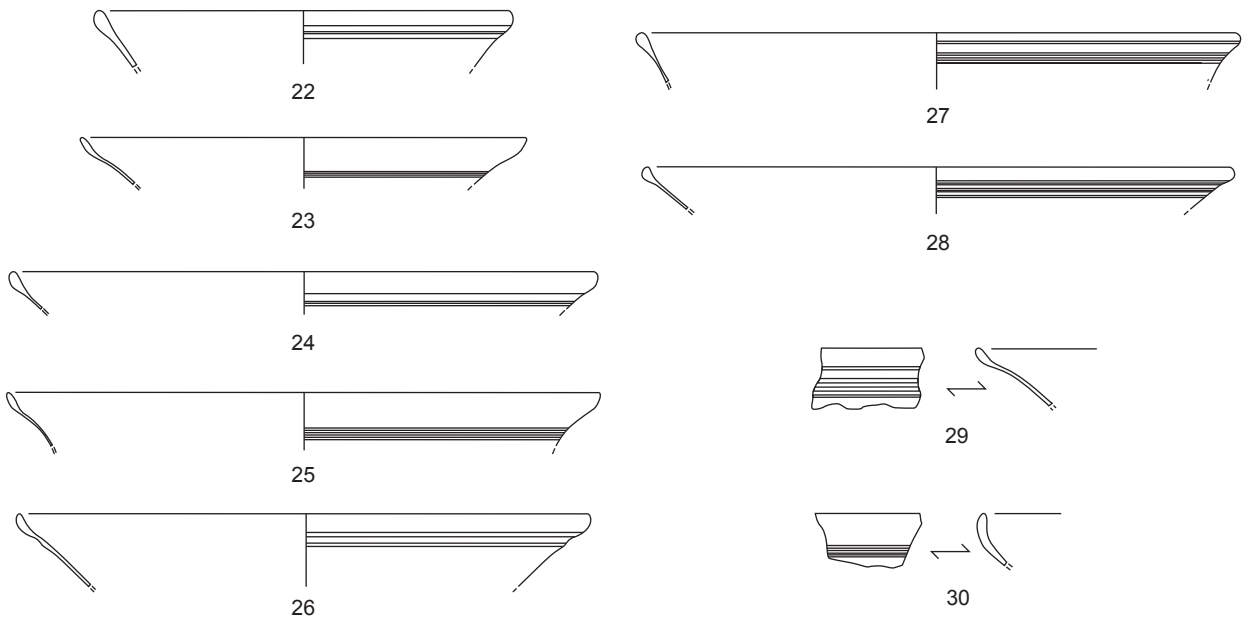

L'Aubert (La Vall d'en Bas) 2006-2013

UE.3061



1

UE.3071

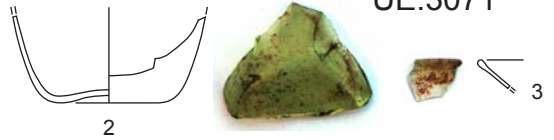

2

3

UE.3132

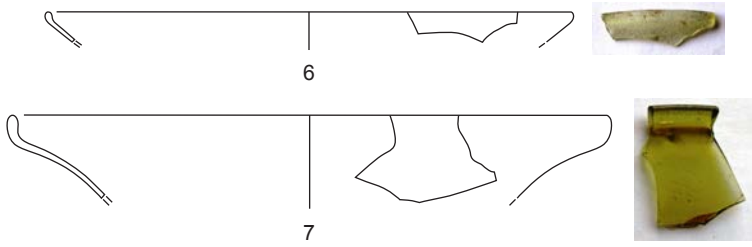

6

7

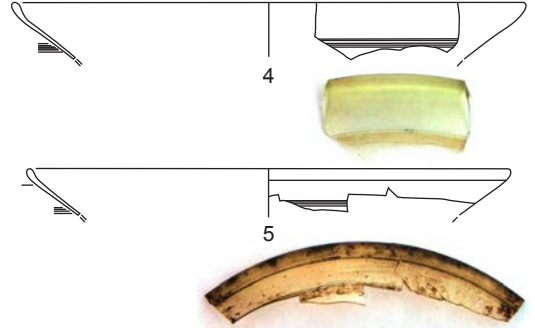

4

5

UE.5004



8

9

Els Ametllers (Tossa de Mar) 2000-2004

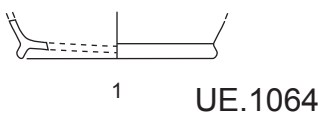

1

UE.1064

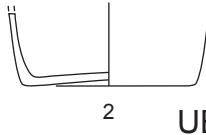

2

UE.1067

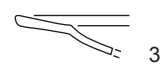

3

UE.1171

UE.1364

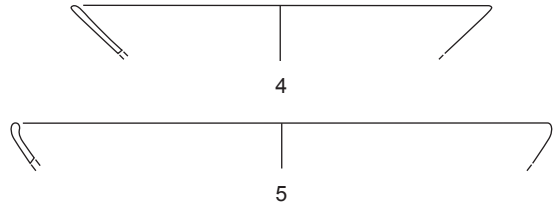

4

5

UE.1097

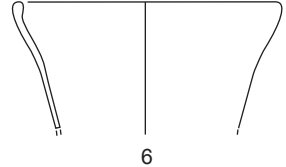

6

UE.1103

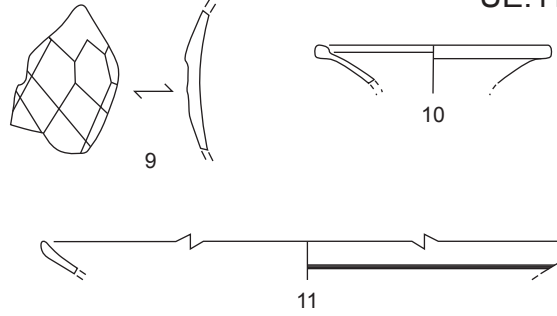

9

10

11

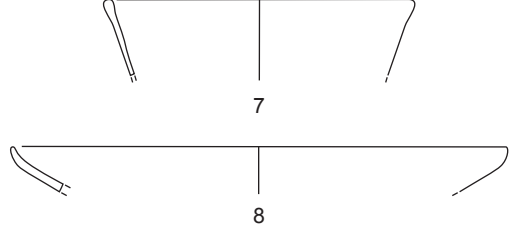

7

8

UE.1683



12

UE.1711

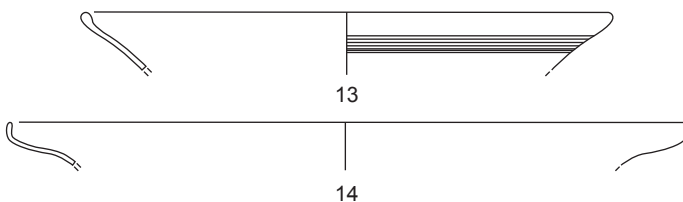

13

14

Dibuixos reelaborats a partir de PALAHÍ-NOLLA 2010

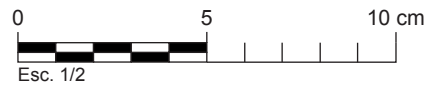

Àmbit IV-UE.2063

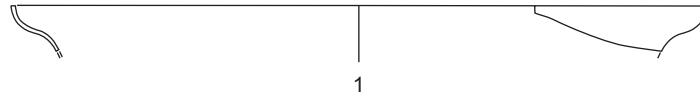

1

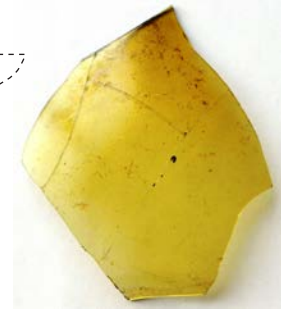
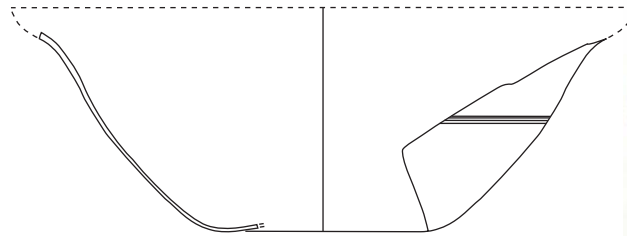

2

Àmbit V-UEs.2015 i 2030

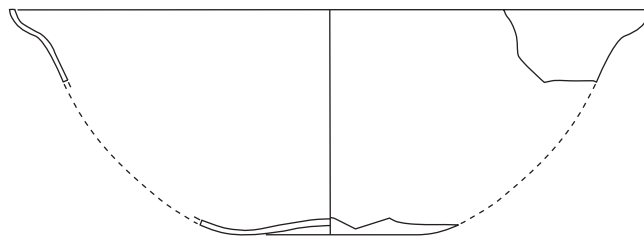

3

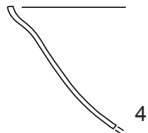

4



5

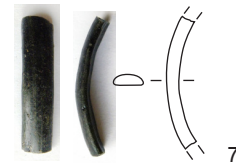

7



6

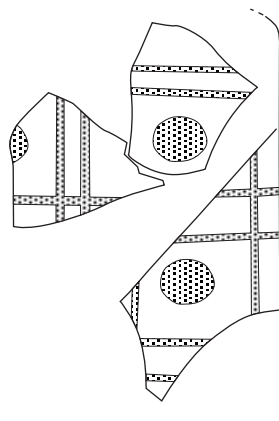

Àmbit VI-UE.2077



8

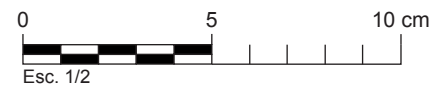



Àmbit VII-UE.2032

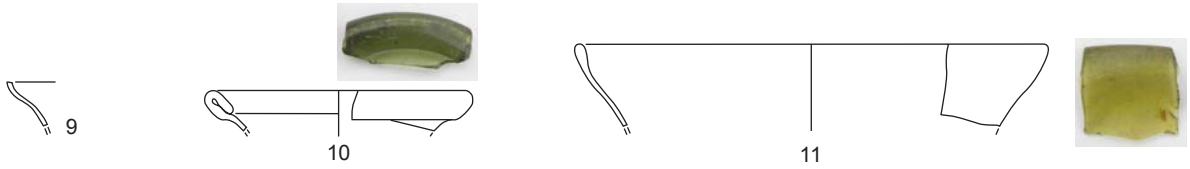

Àmbit VII-UE.2122

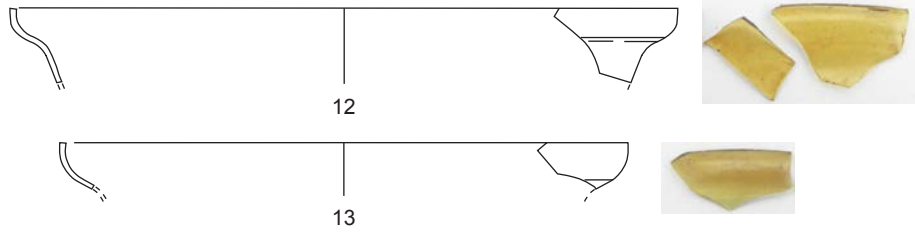

Àmbit VII-UE.2124

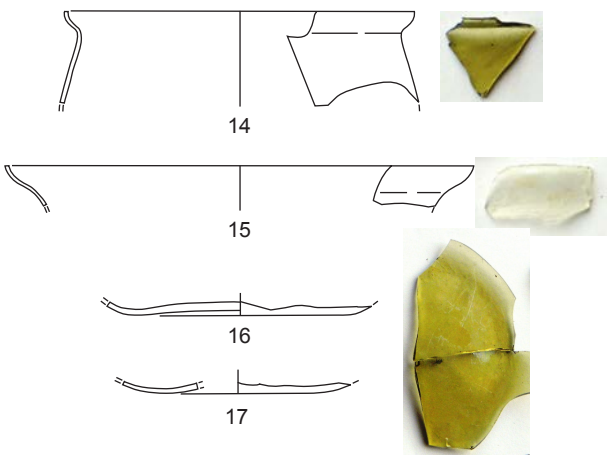

Àmbit VII-UE.2125

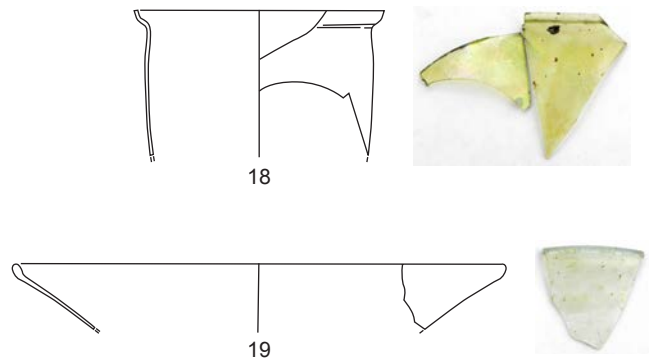

Àmbit VII-UE.2143

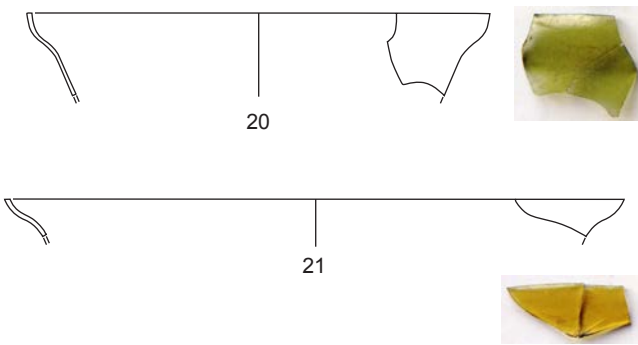

Àmbit VII-UE.2162

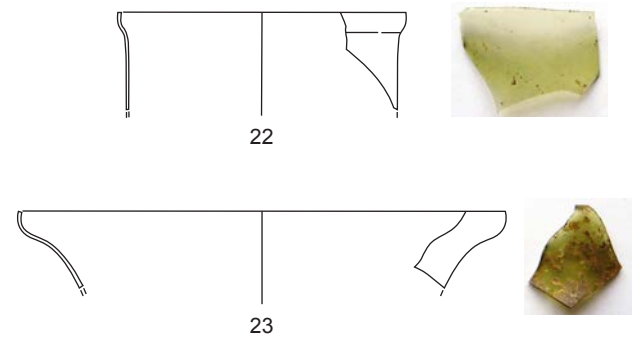

Àmbit VII-UE.2232

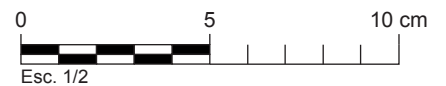
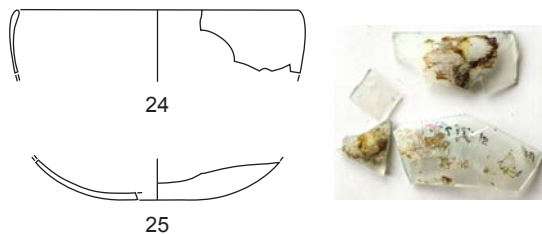

Àmbit VIII-UE.2240



Pati-UEs.2236 i 2238

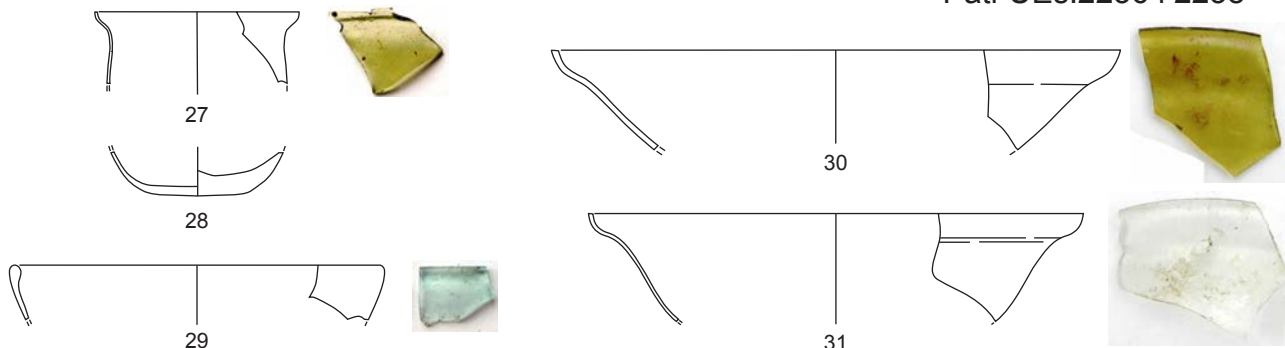

Àmbit XIV-UE.3018

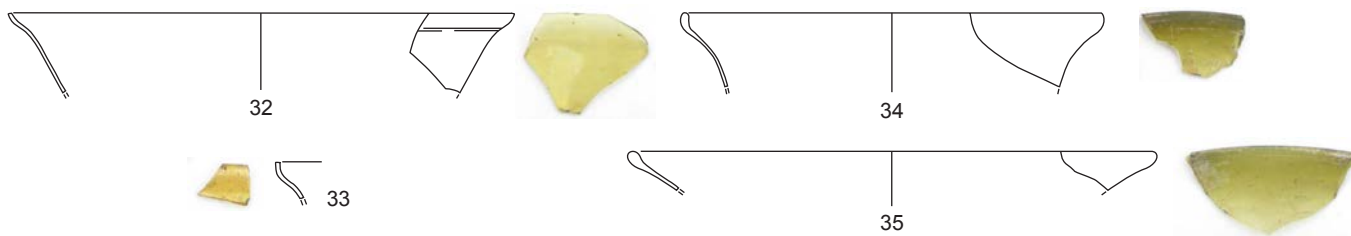

Àmbit XIV-UE.3024

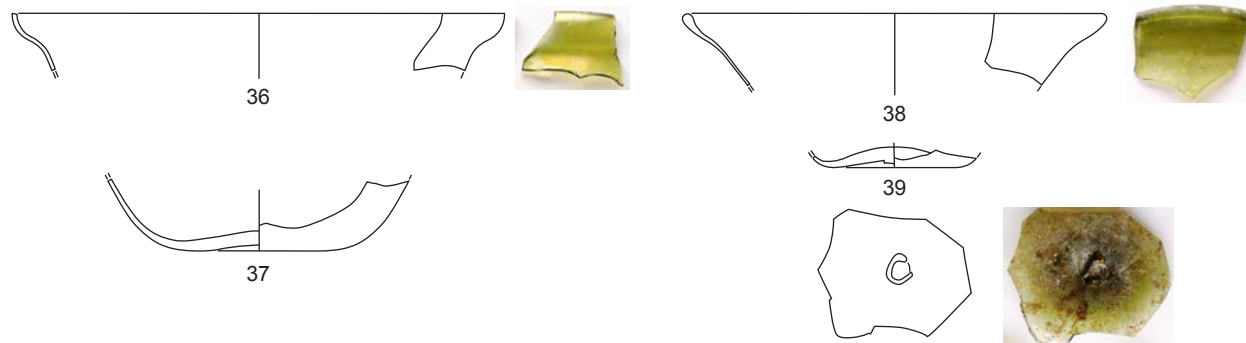

Àmbit XIV-UE.3057

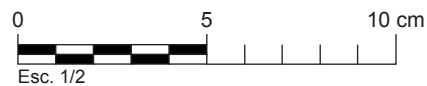
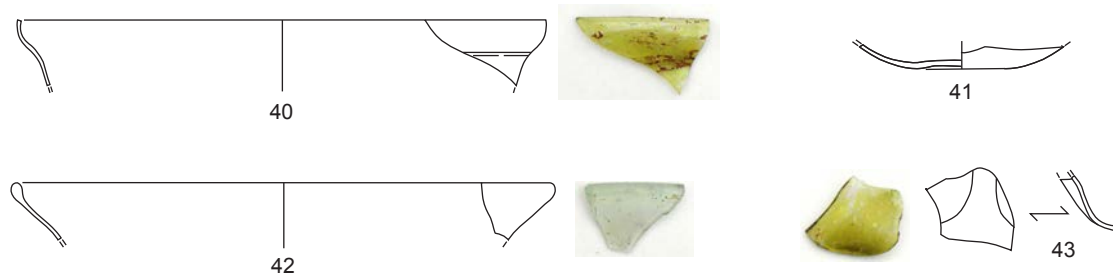

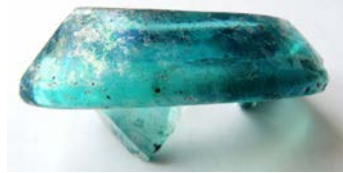
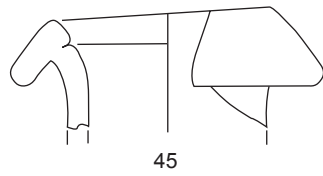
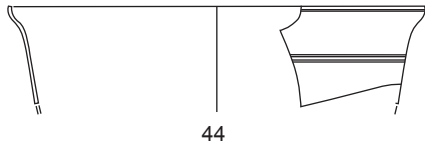

Superficial-UE.1001

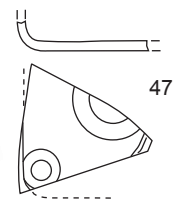
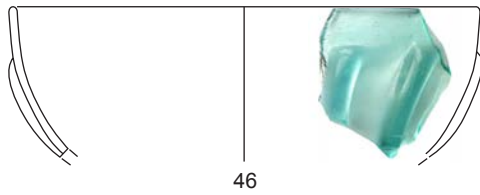

Superficial-UE.2001

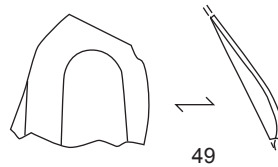
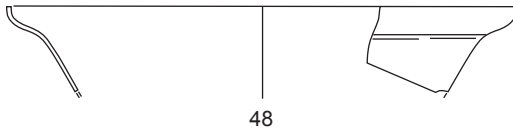

Superficial-UE.3001

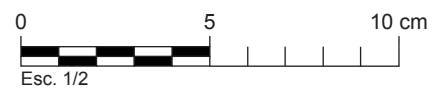
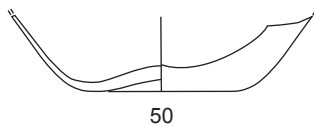

Torre Llauder-1981

Tablini-Fossa 3. UE.3

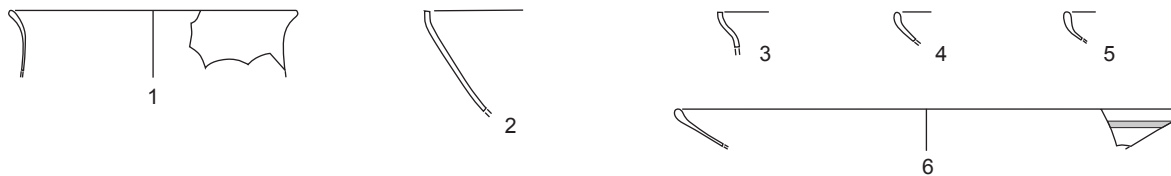

Torre Llauder-1982

Abocador UE. 1

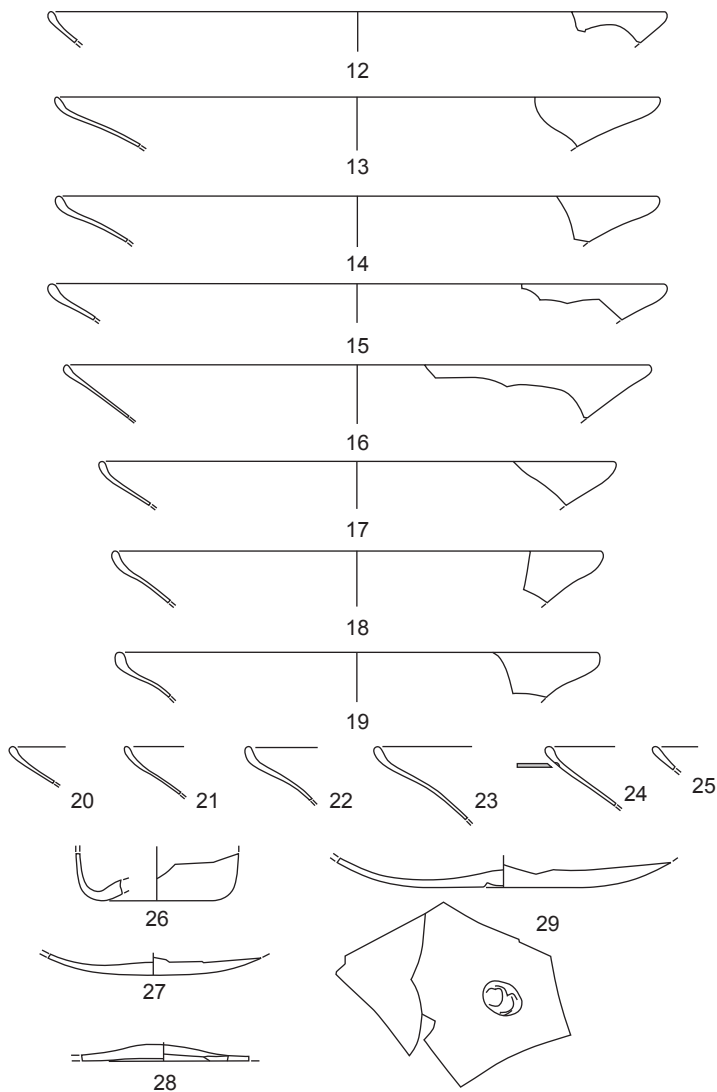
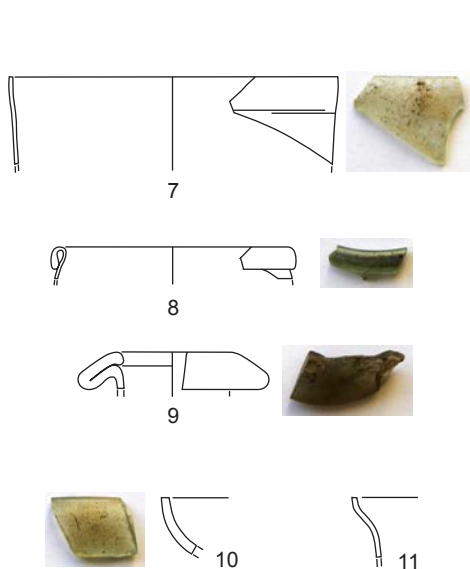

Abocador UE.2

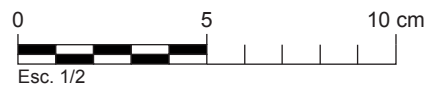
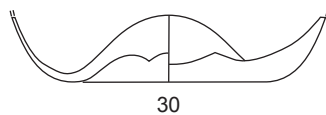

Abocador UE.3

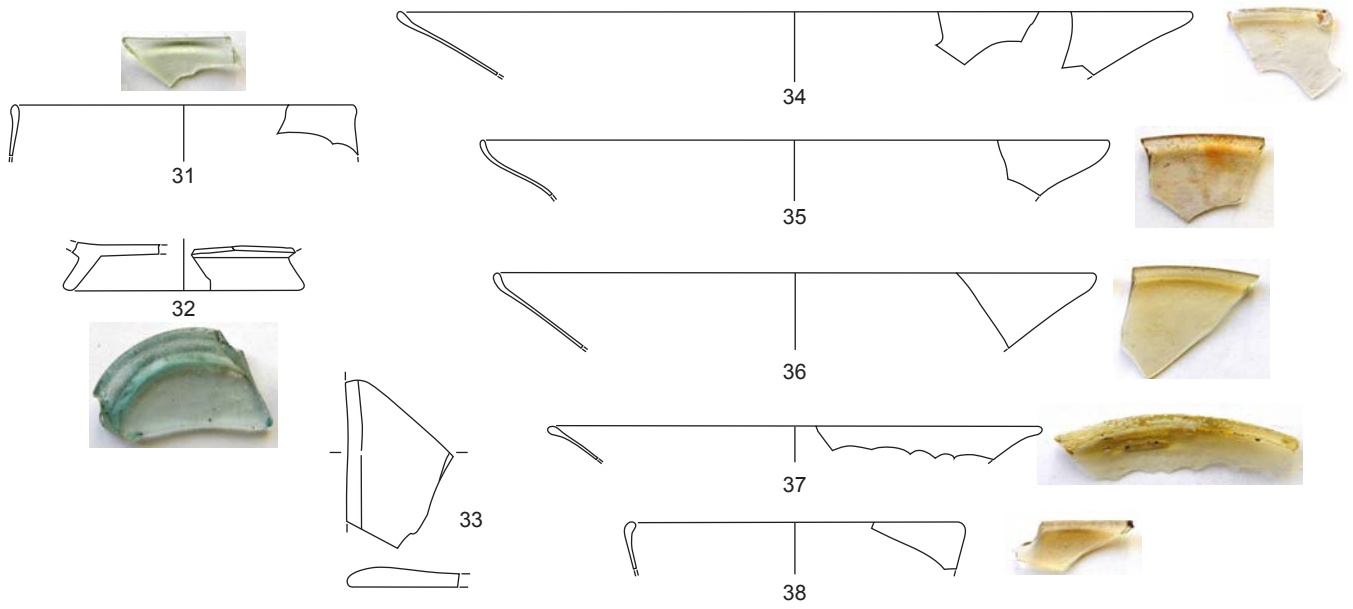

Pou UE.4

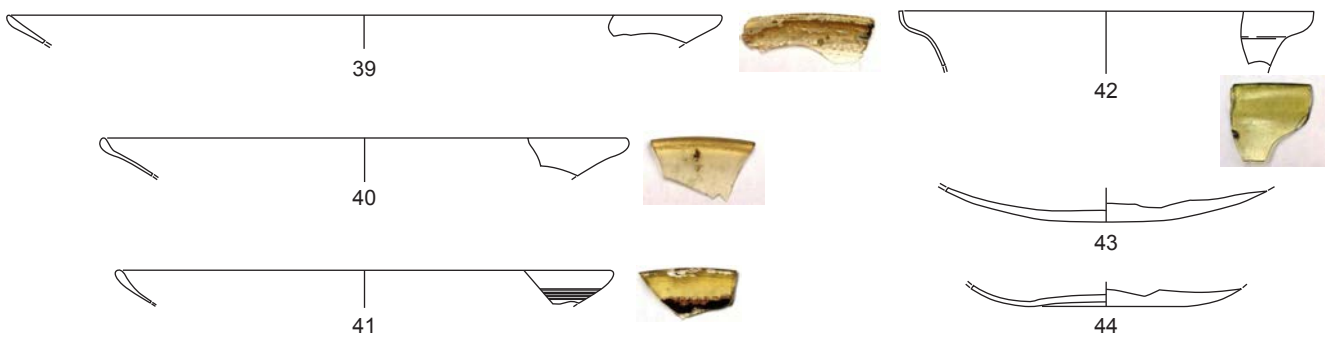

Centre Abocador.UE.1

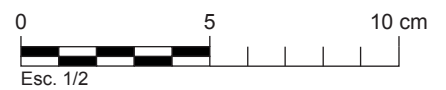
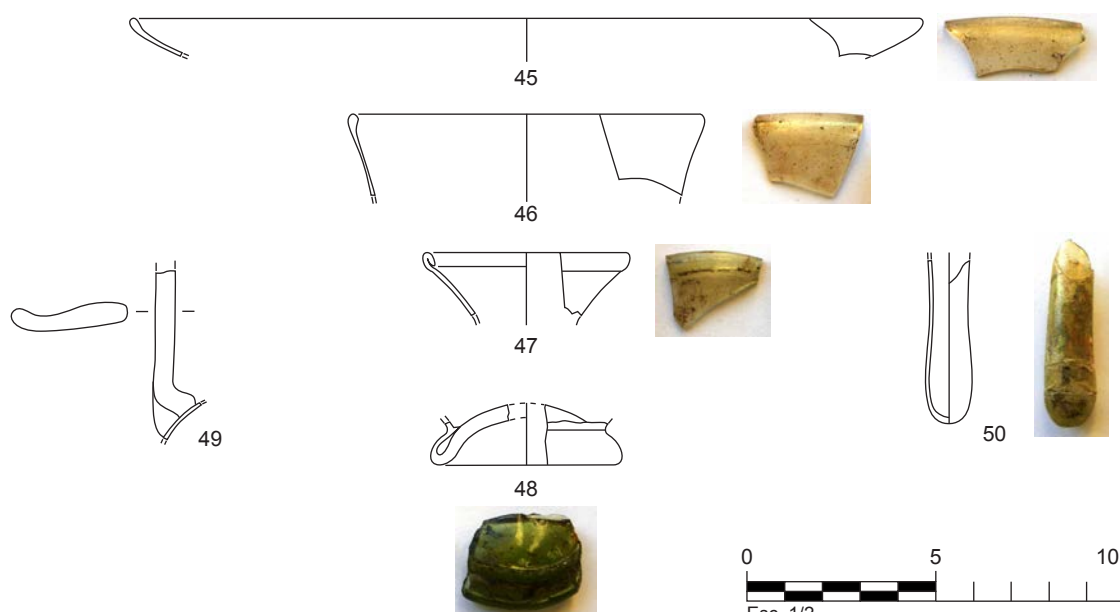

Torre Llauder-1986

UE.14

UE.24

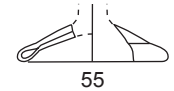
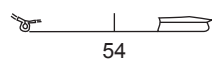
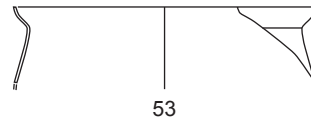
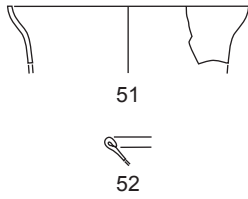

UE.26

UE.27

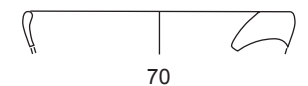
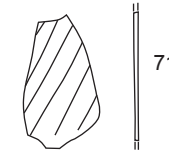
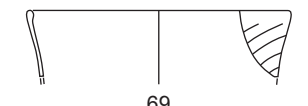
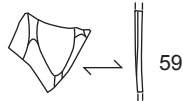
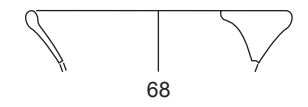
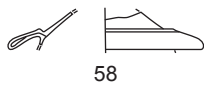
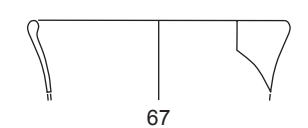
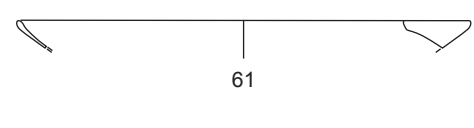
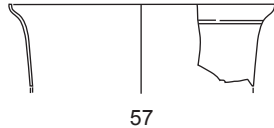
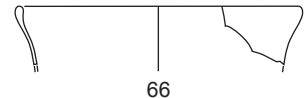
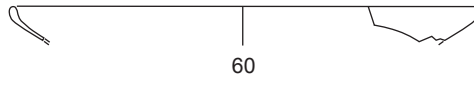
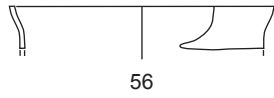

UE.32

UE.33

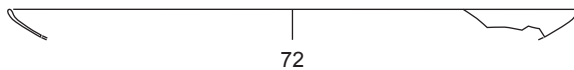

UE.35

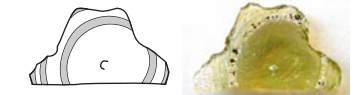
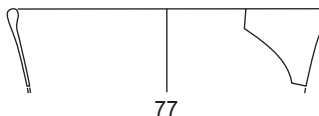
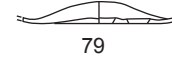
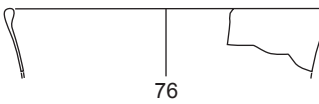
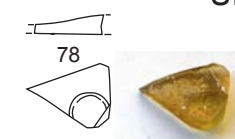
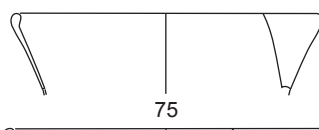
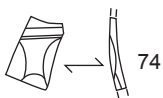

UE.38

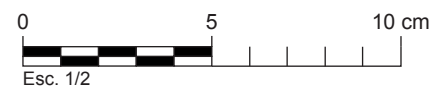
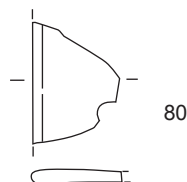

UE.64

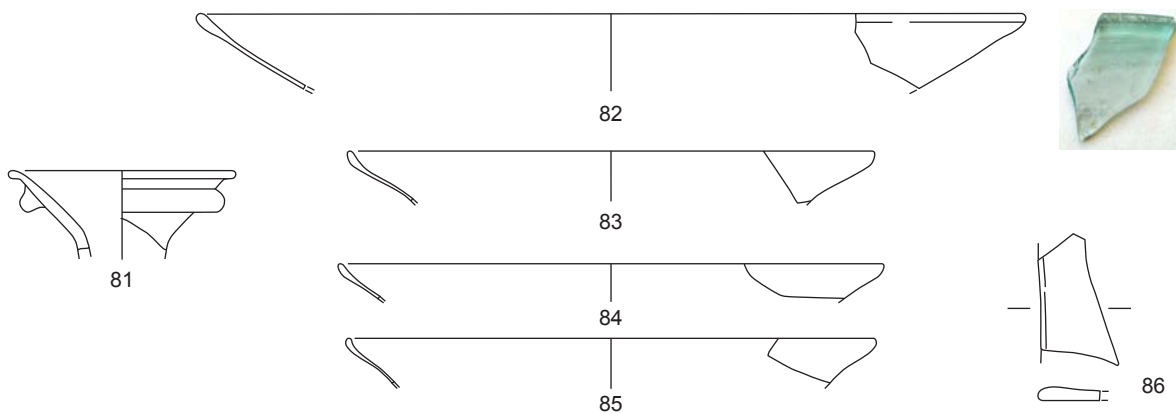

UE.100

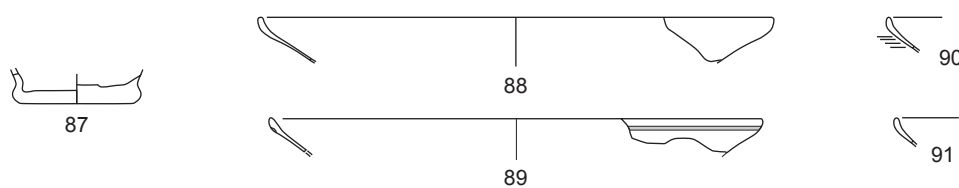

Torre Llauder-1989

H.1-UE.25

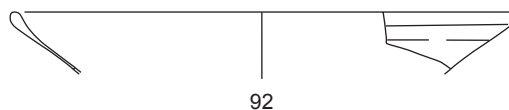

Torre Llauder-2007

UE.Superficial



UE.4006



UE.4015

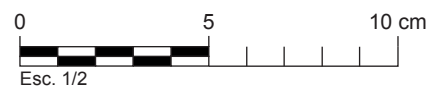
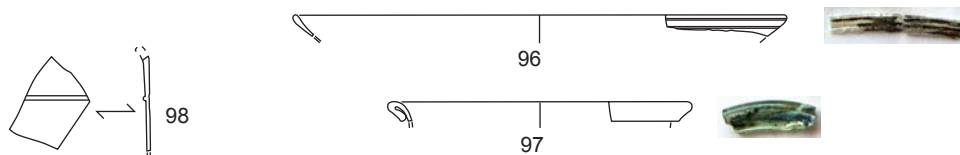

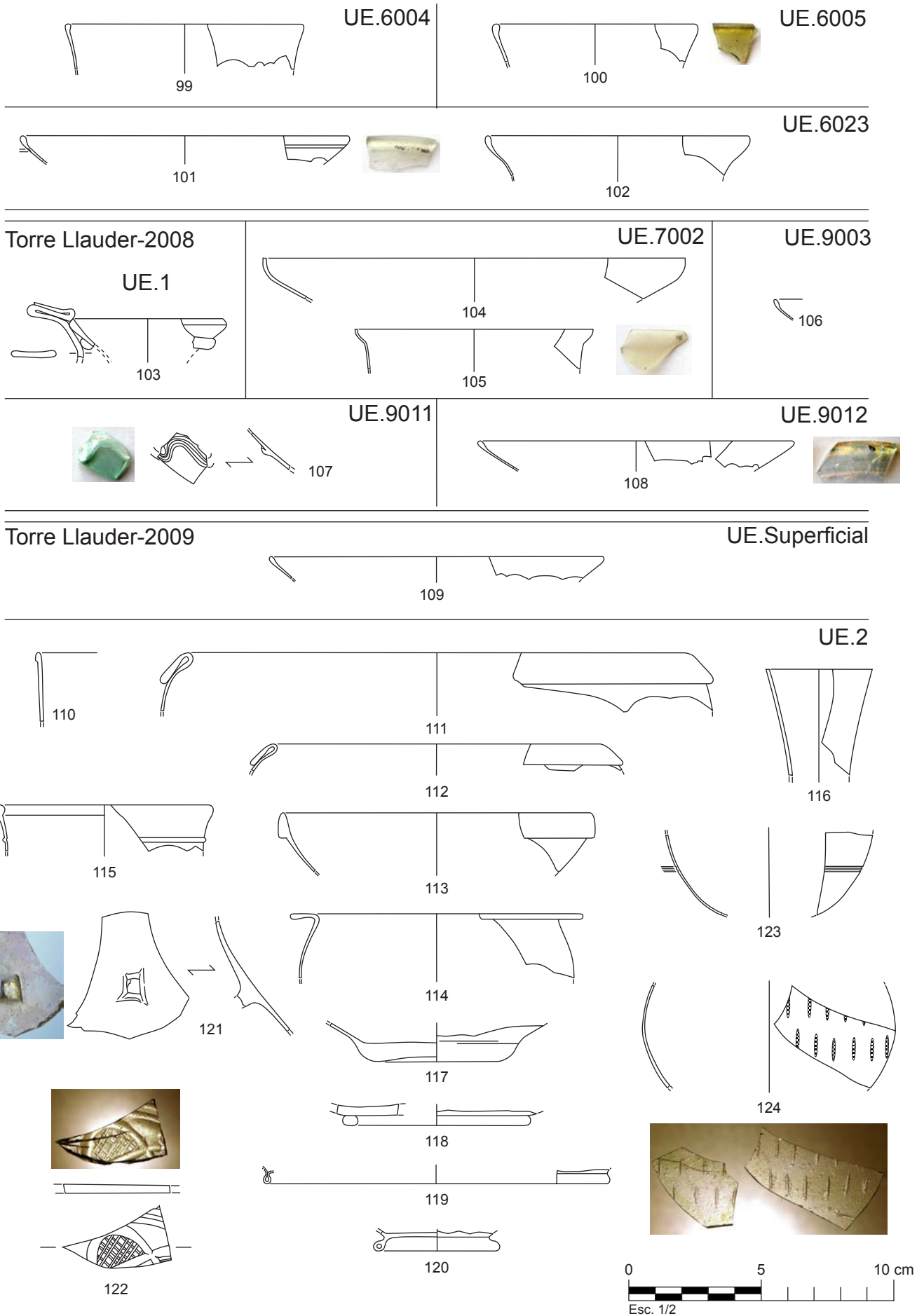



UE.2

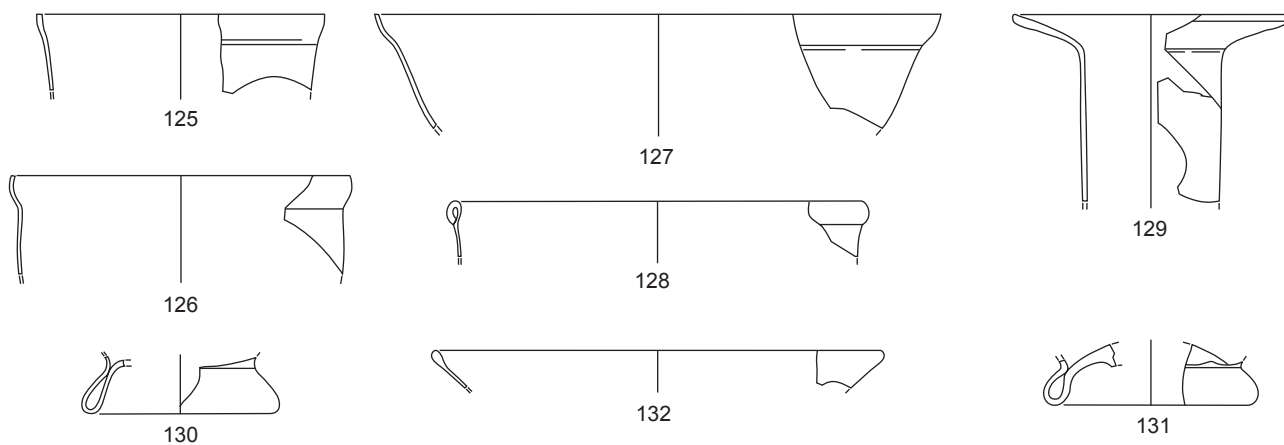

UE.4

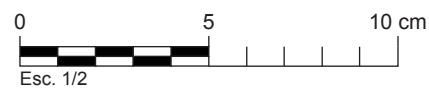
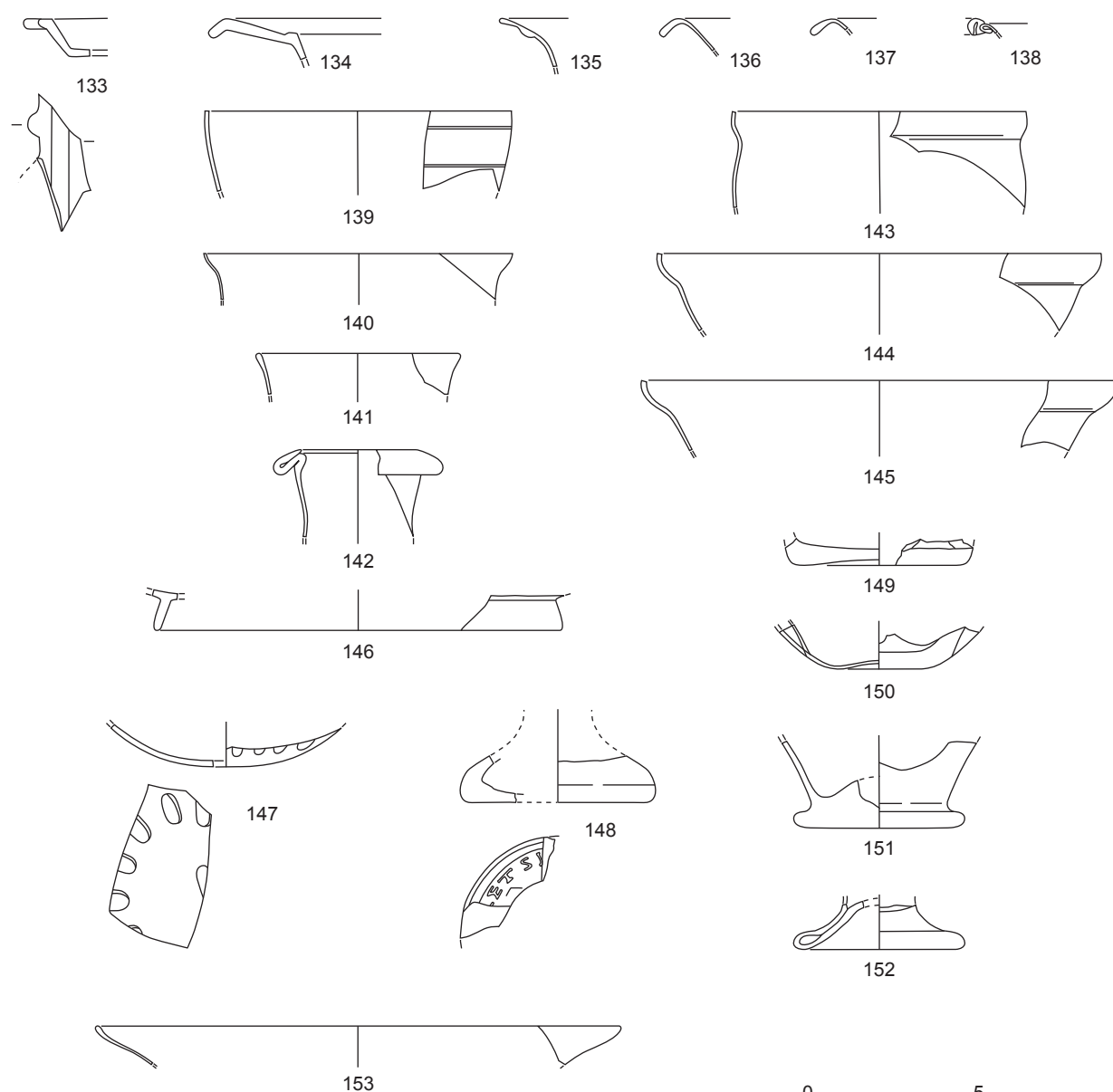

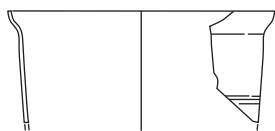

154



155

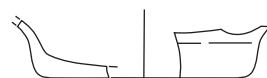

156

UE.177

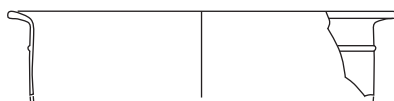

157

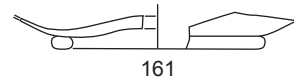

161

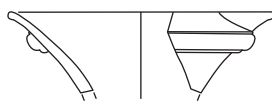

158

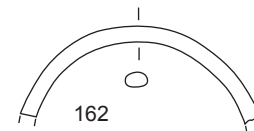

162

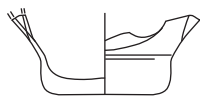

159

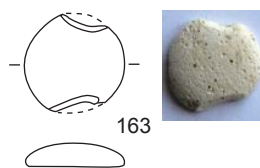

163

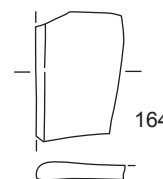

164

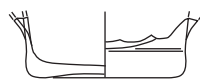

160

UE.180

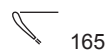

165

UE.202



166

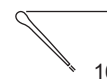

167



168

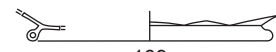

169

UE.209

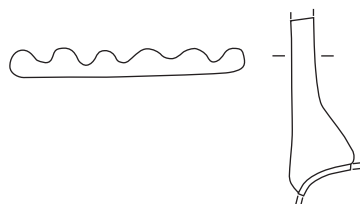

170

UE.1022

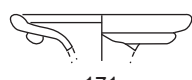

171

UE.2005



172

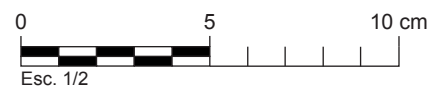

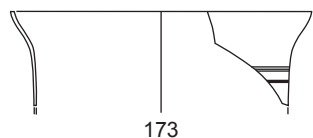

173

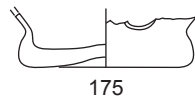

175

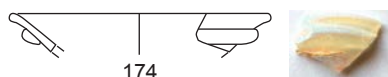

174



176



177

UE.1009



178

UE.2002

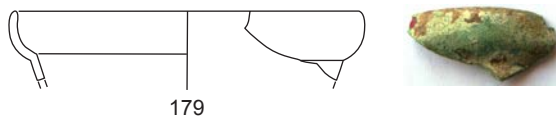

179

UE.5003



180



181

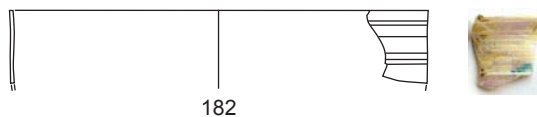

182



183

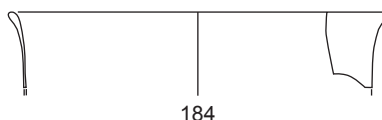

184

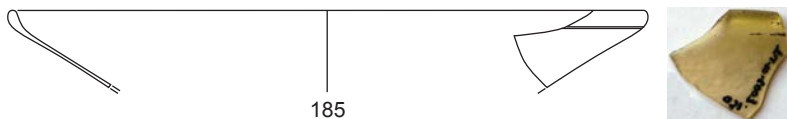

185



186



187



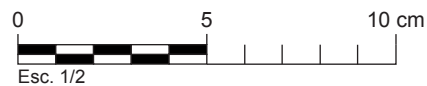
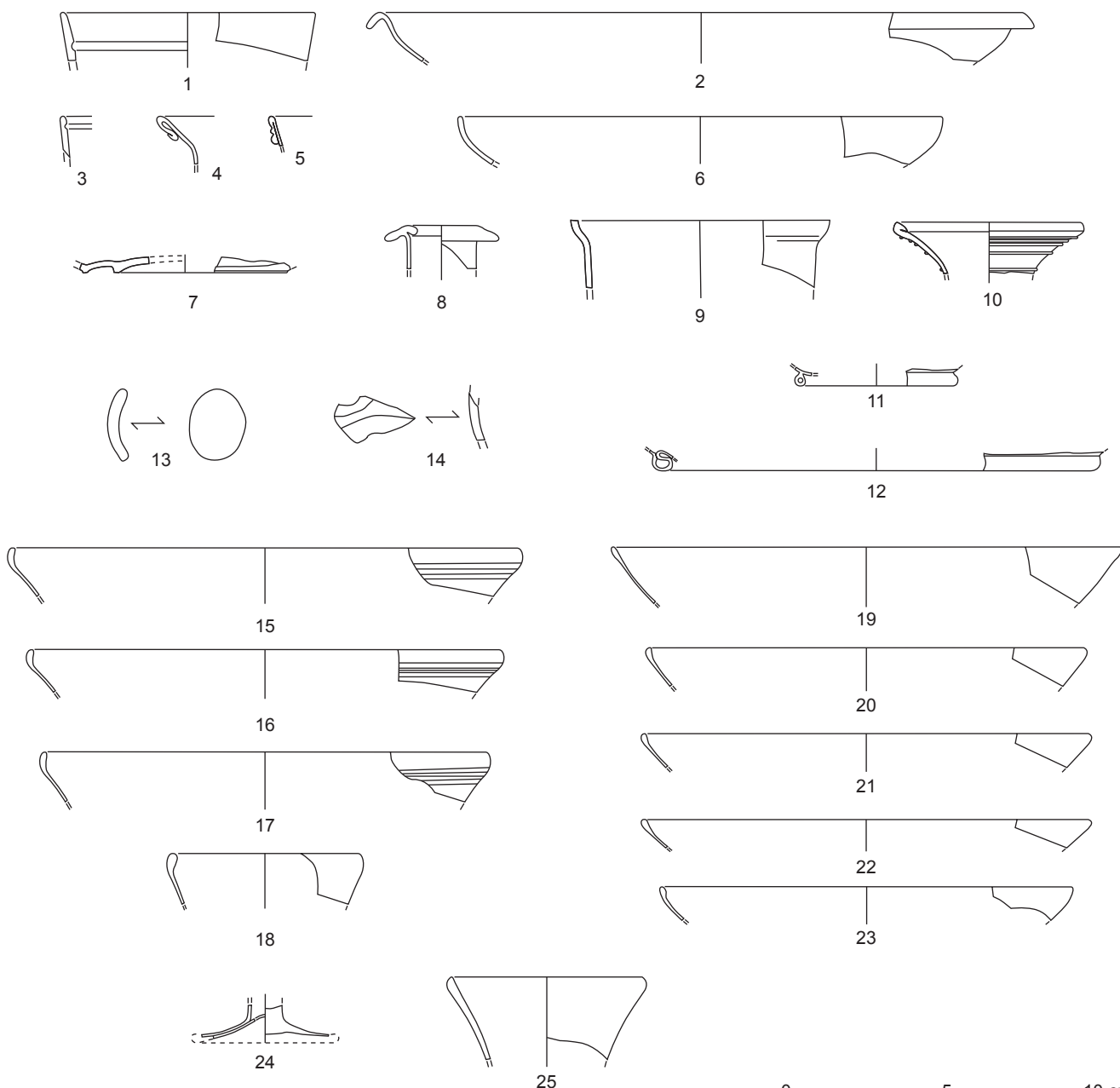
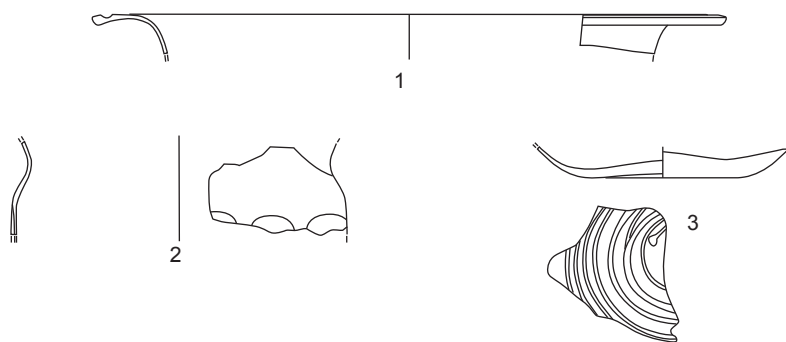

UE.1041

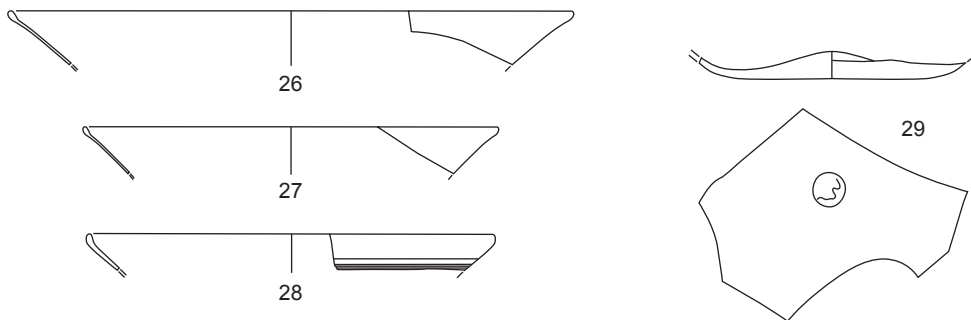

El Carreró 49

UE.1006

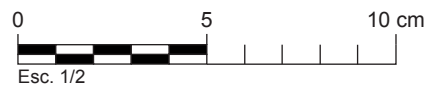
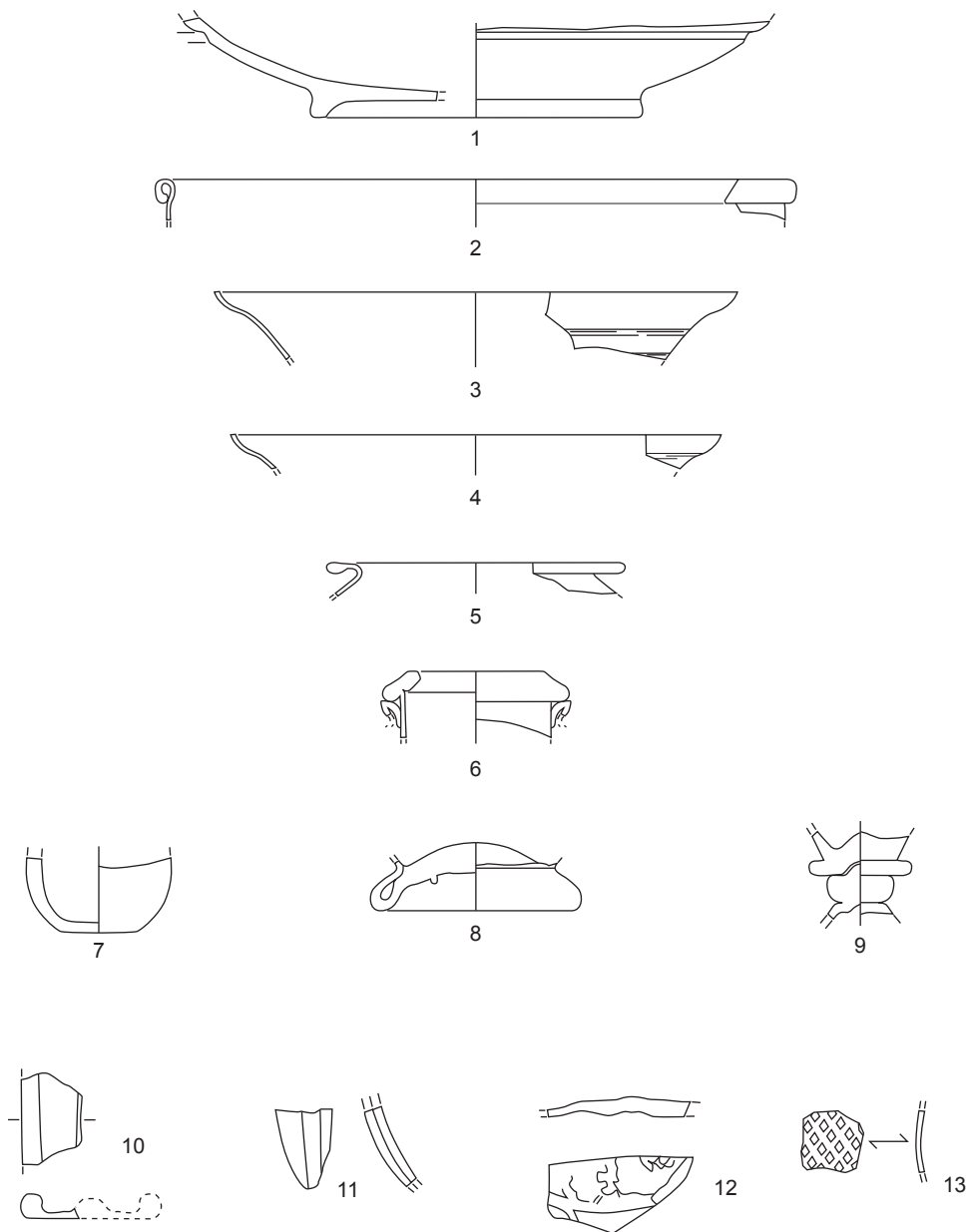

C/ MAGÍ DE VILALLONGA 8-12 i 015.EL CARRERÓ 49 (Mataró), 1999-2000 i 1997

LÀMINA 42

MAG8-12'99-00: ue.1041; CAR49'97: ue.1006 (dibuixos reelaborats a partir de M. PÉREZ-SALA 2004)

Cronologia: s. V-VI

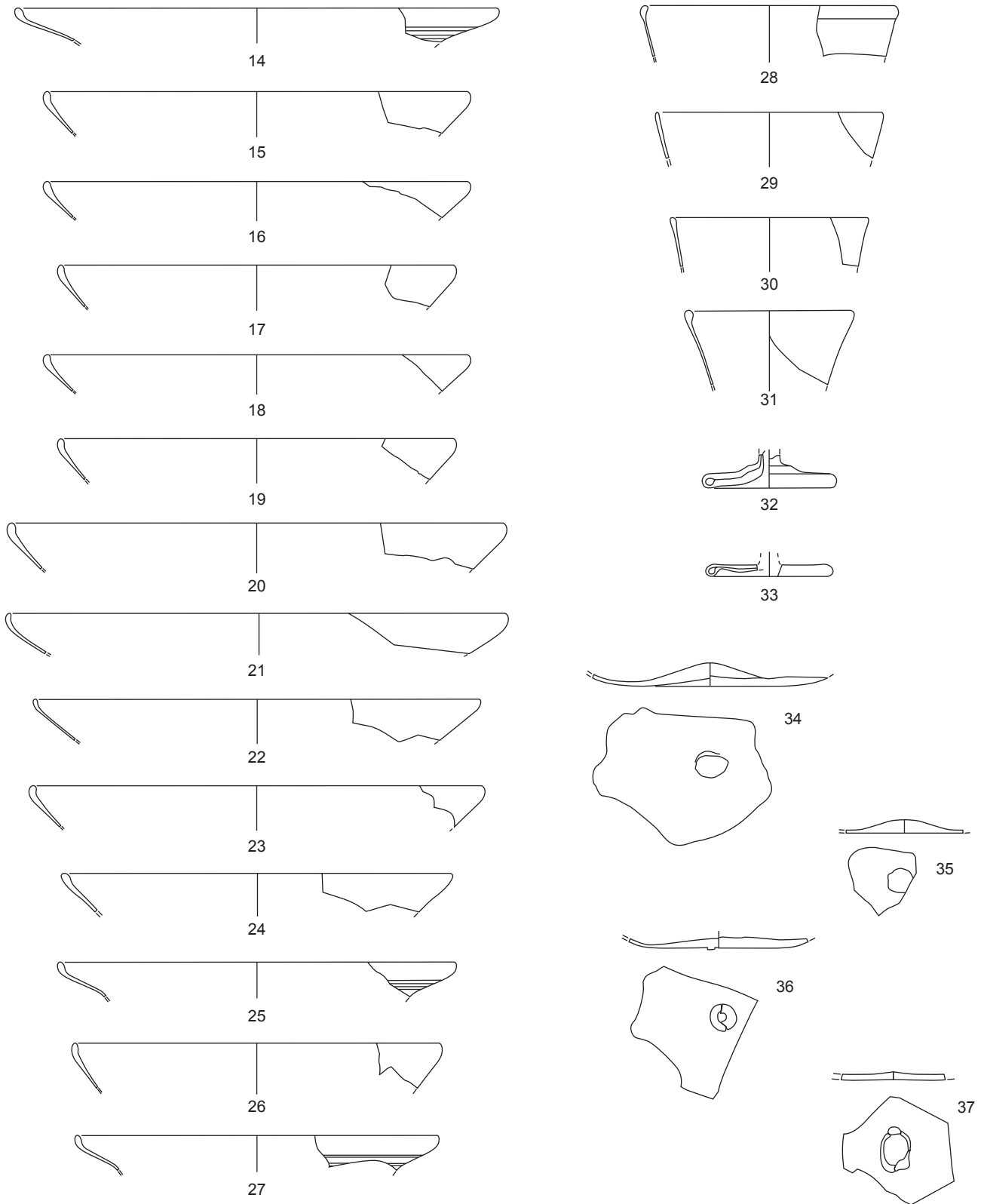

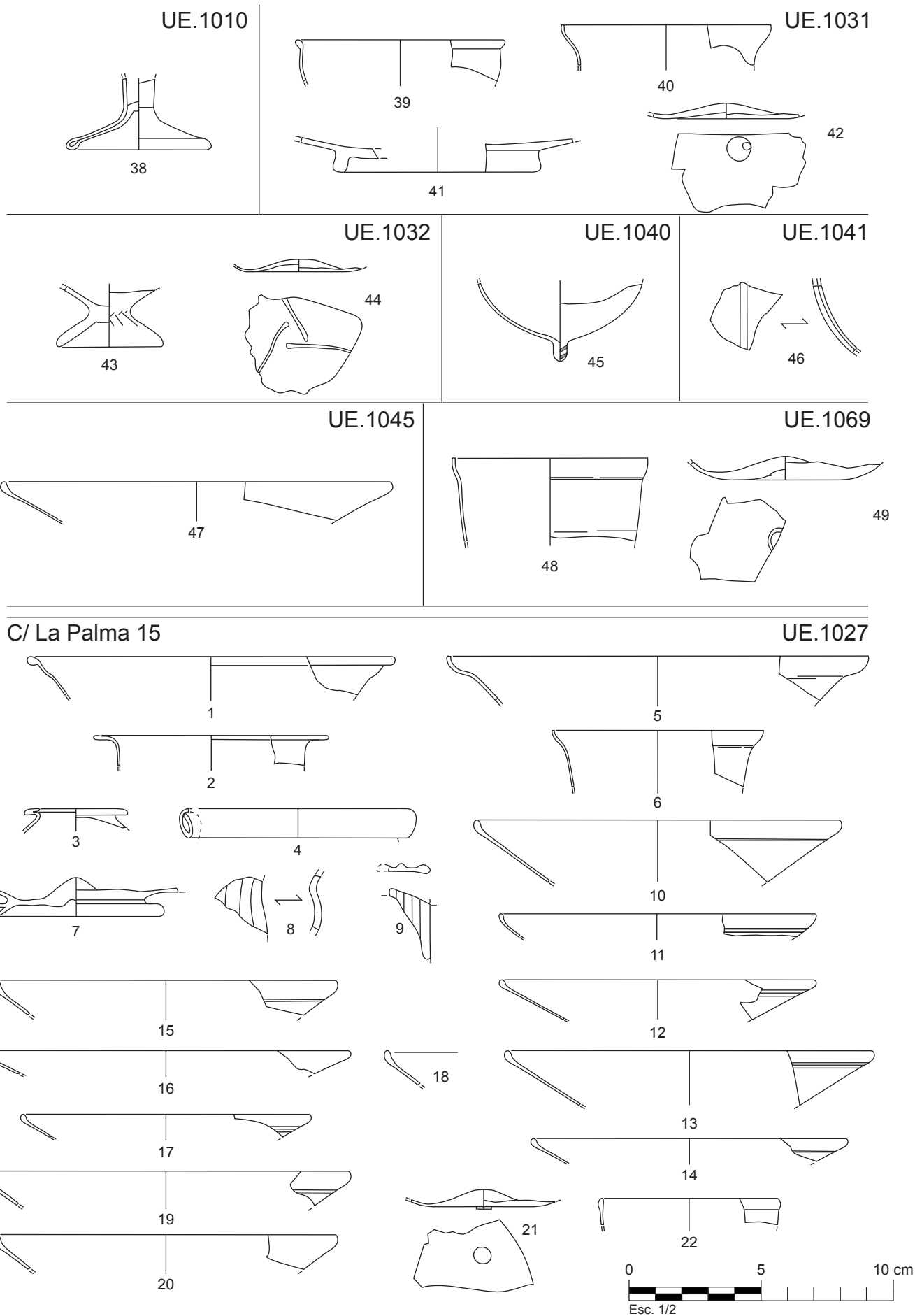

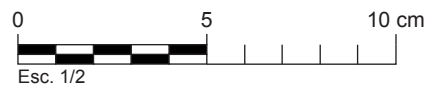
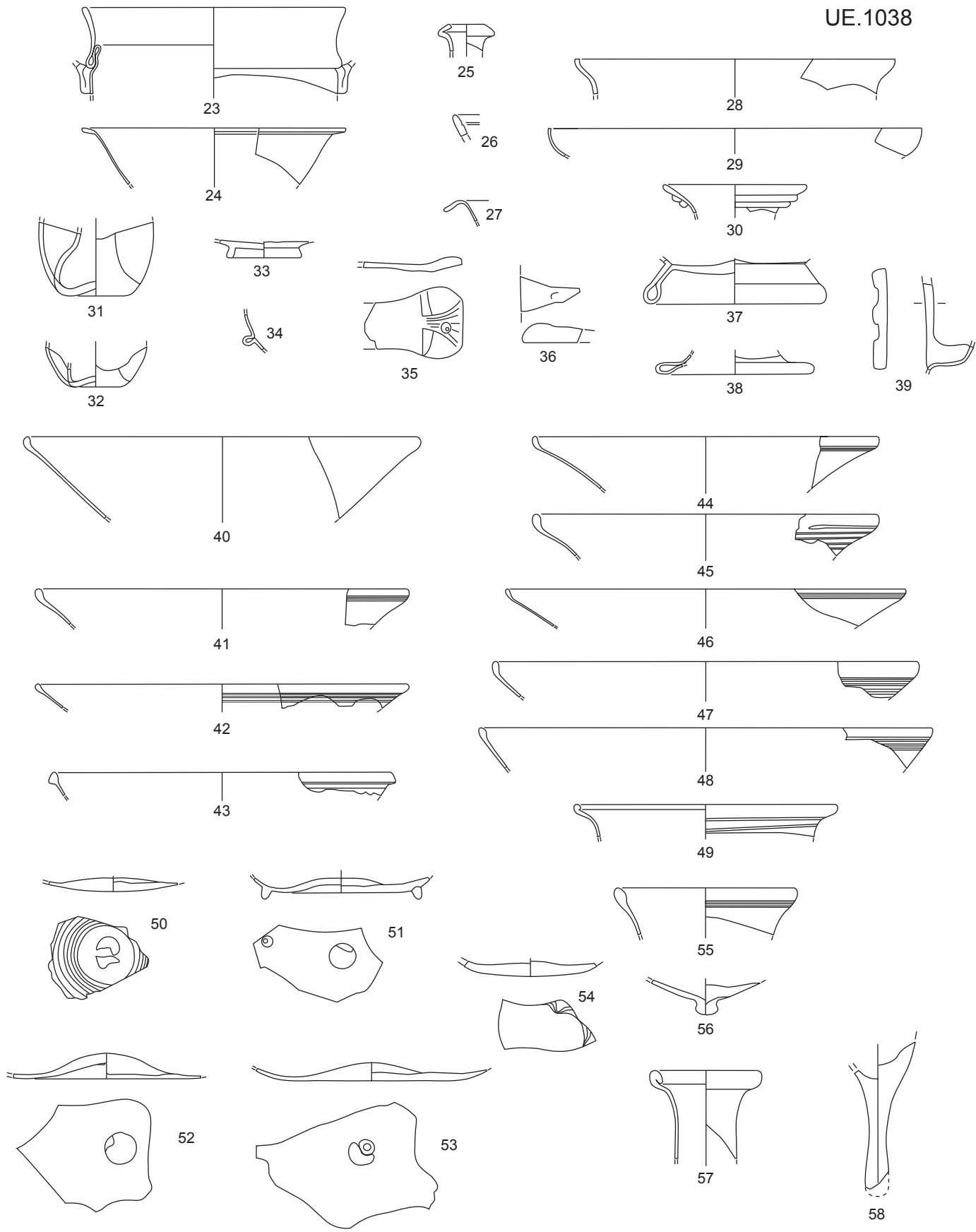



UE.1039

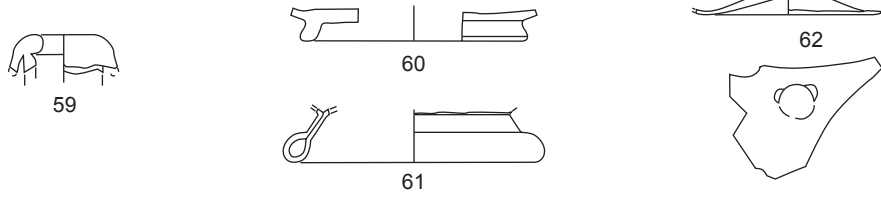

UE.1042

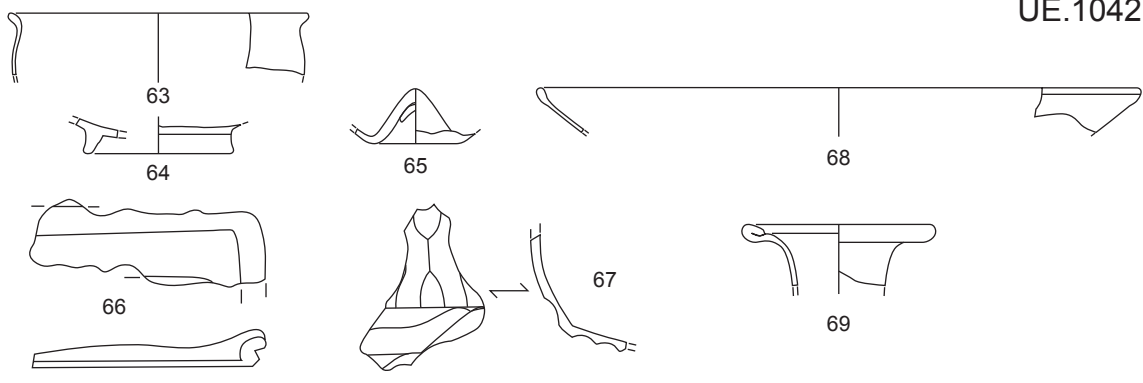

UE.1097

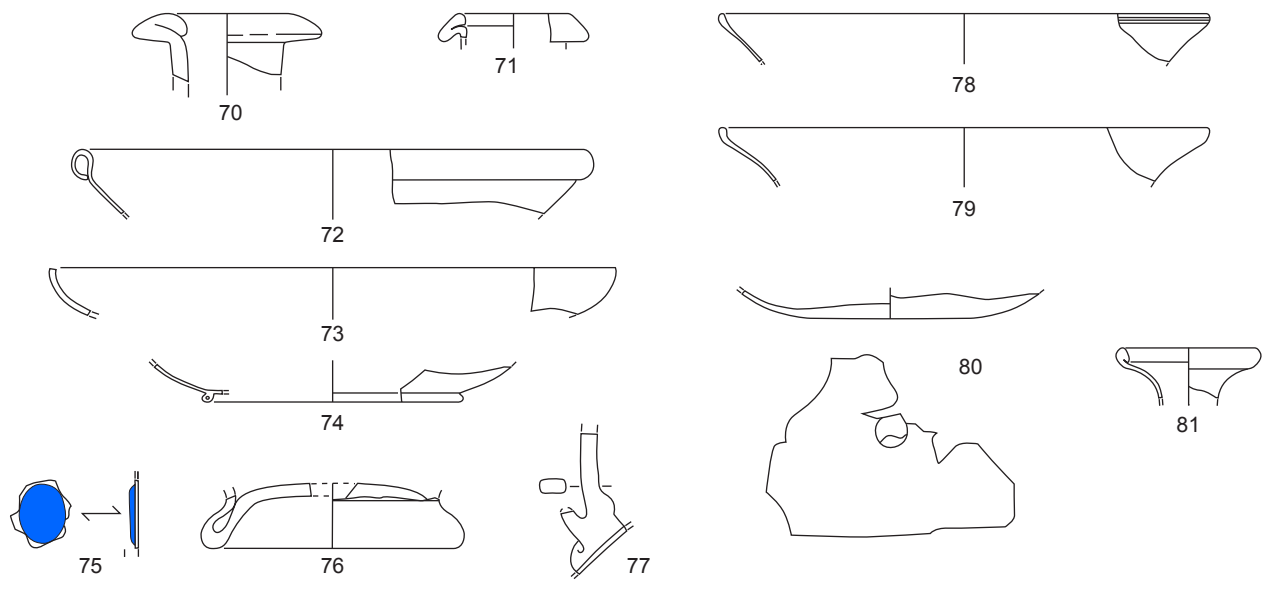

UE.1099

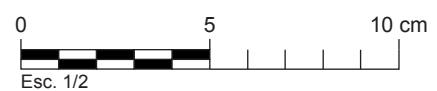
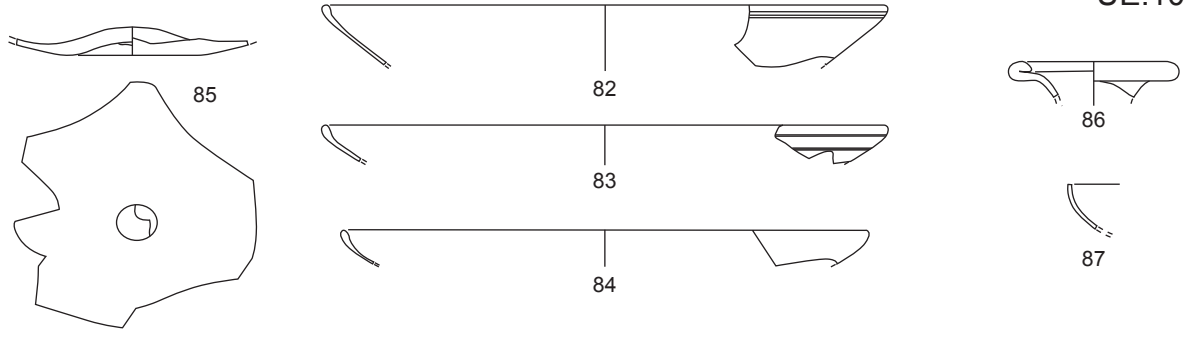

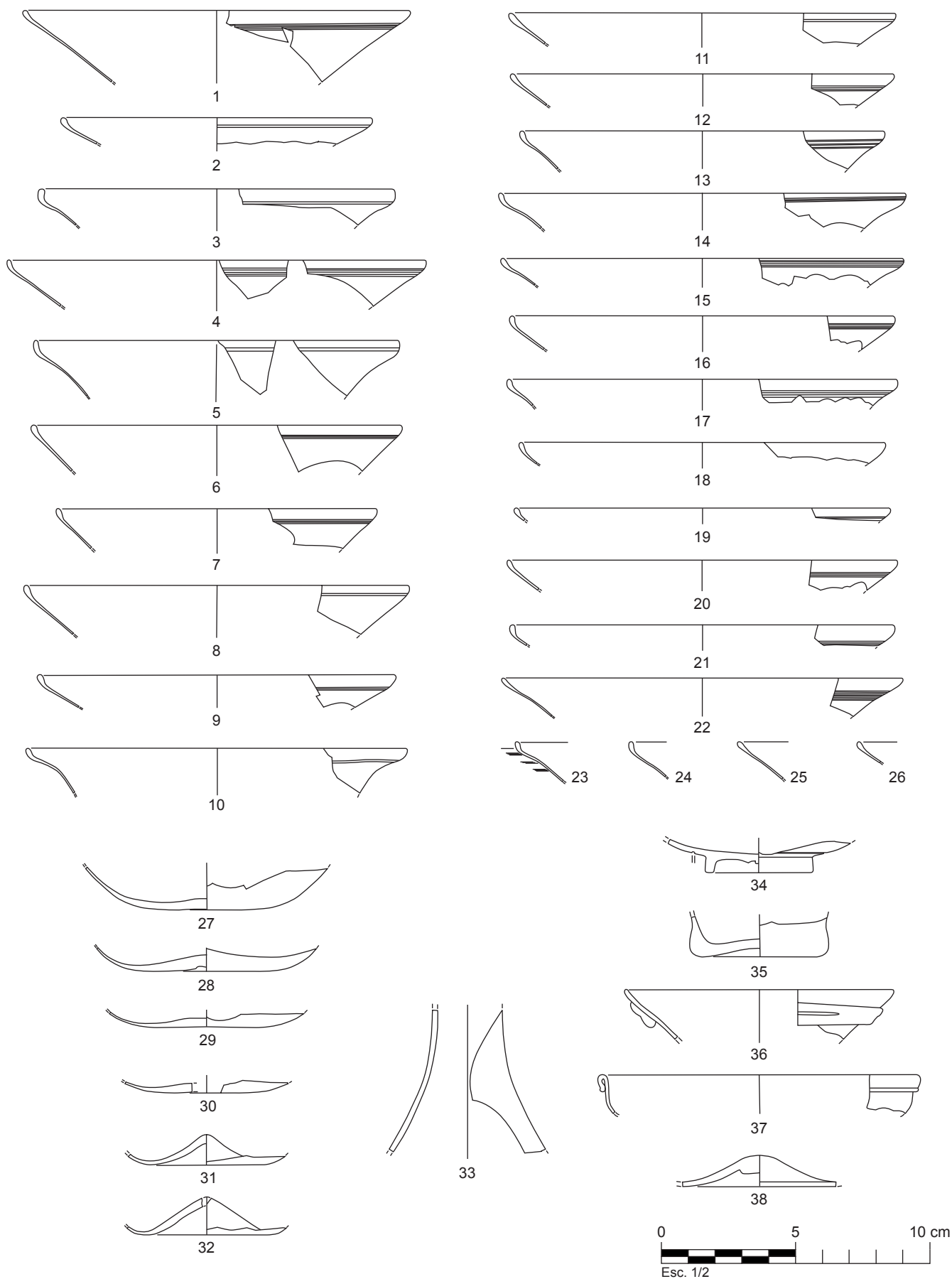

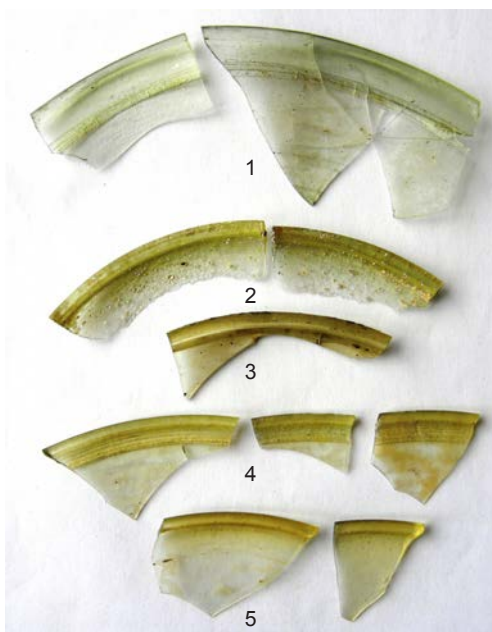

Vores d'escudelles Foy 21a



Vores d'escudelles Foy 21a



Les tres coloracions de la massa de vidre presents al context



Fons d'escudelles Foy 21a



↔

Detall de l'empremta del puntill



Fons d'escudelles Foy 21a



↔

Detall de l'empremta del puntill



Fragments de vidre residual d'època romana



Fons cònics de flascons o ampolles



Fons d'escudelles Foy 21a

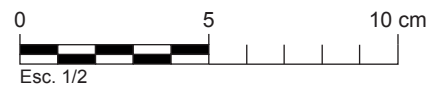

El Carreró 2006

UE.1056

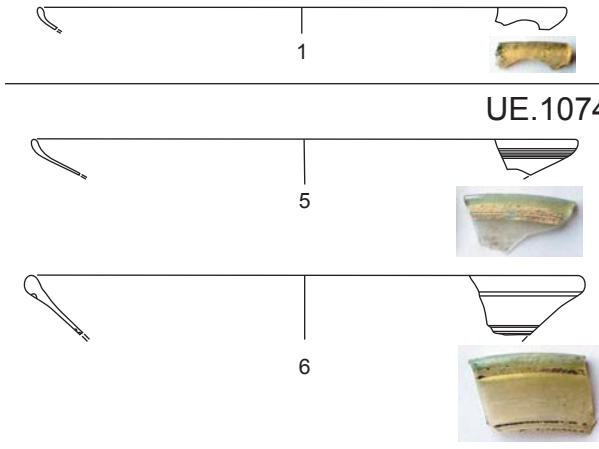

UE.1060

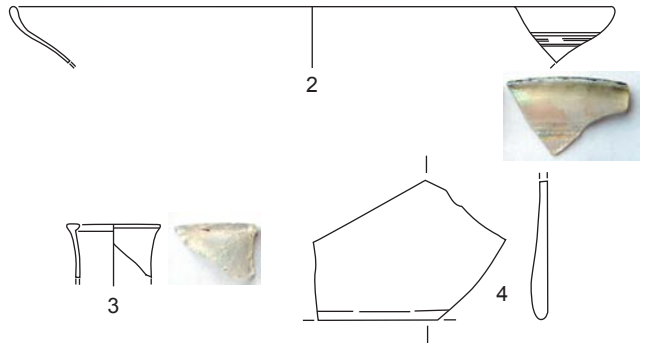

UE.1074

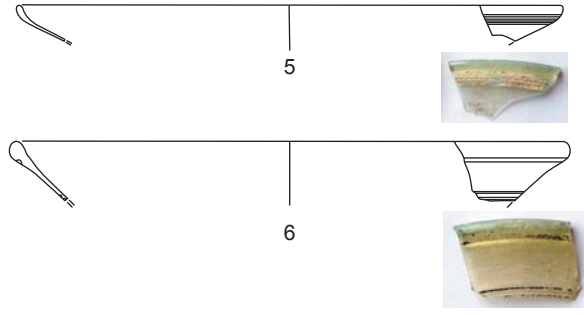

UE.1077

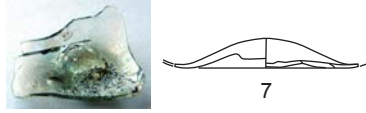

C/ Sant Simó 2010

UE.104

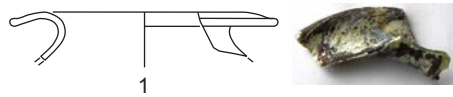

UE.109

UE.120

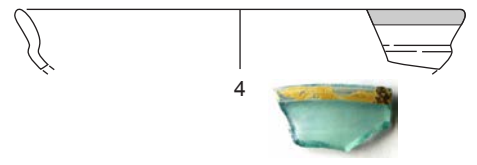
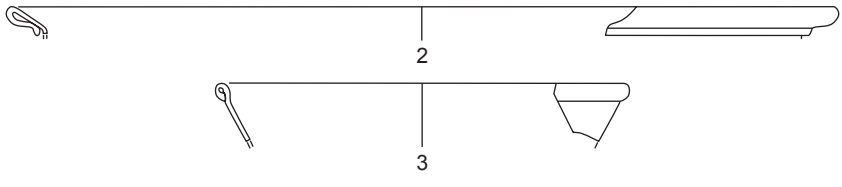

UE.122

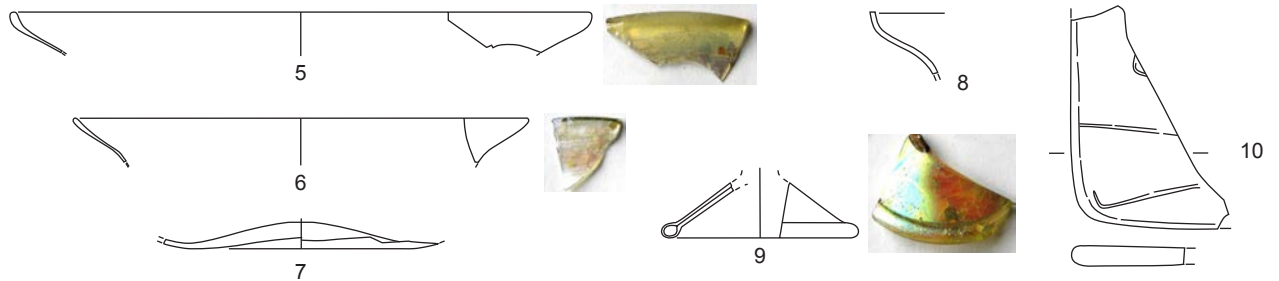

UE.127

UE.130

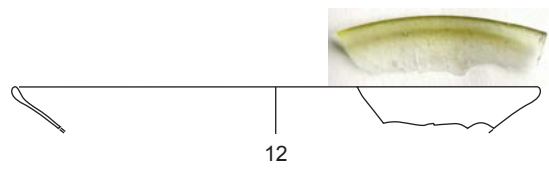
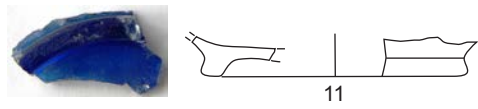

UE.137

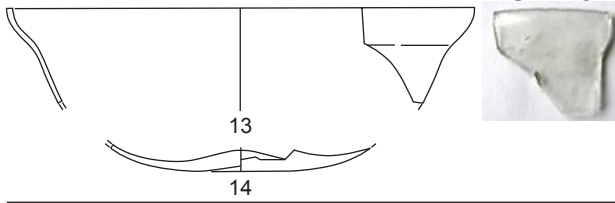

UE.150

UE.152

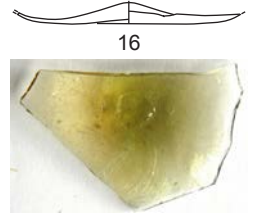
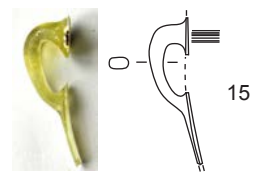

UE.197

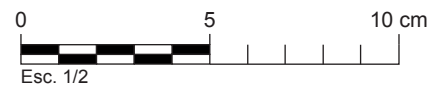
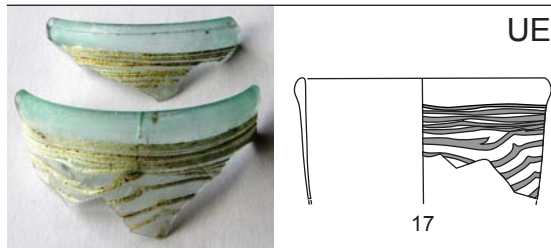

EL CARRERÓ 21-25 i CARRER SANT SIMÓ 2-4 (Mataró, Maresme), 2006 i 2010

LÀMINA 48

C'06: ues.1056, 1060, 1070, 1074 i 1077. SS'10: ues.104, 109, 120, 122, 127, 130, 137, 150, 152 i 197

Cronologia: s. V-VI

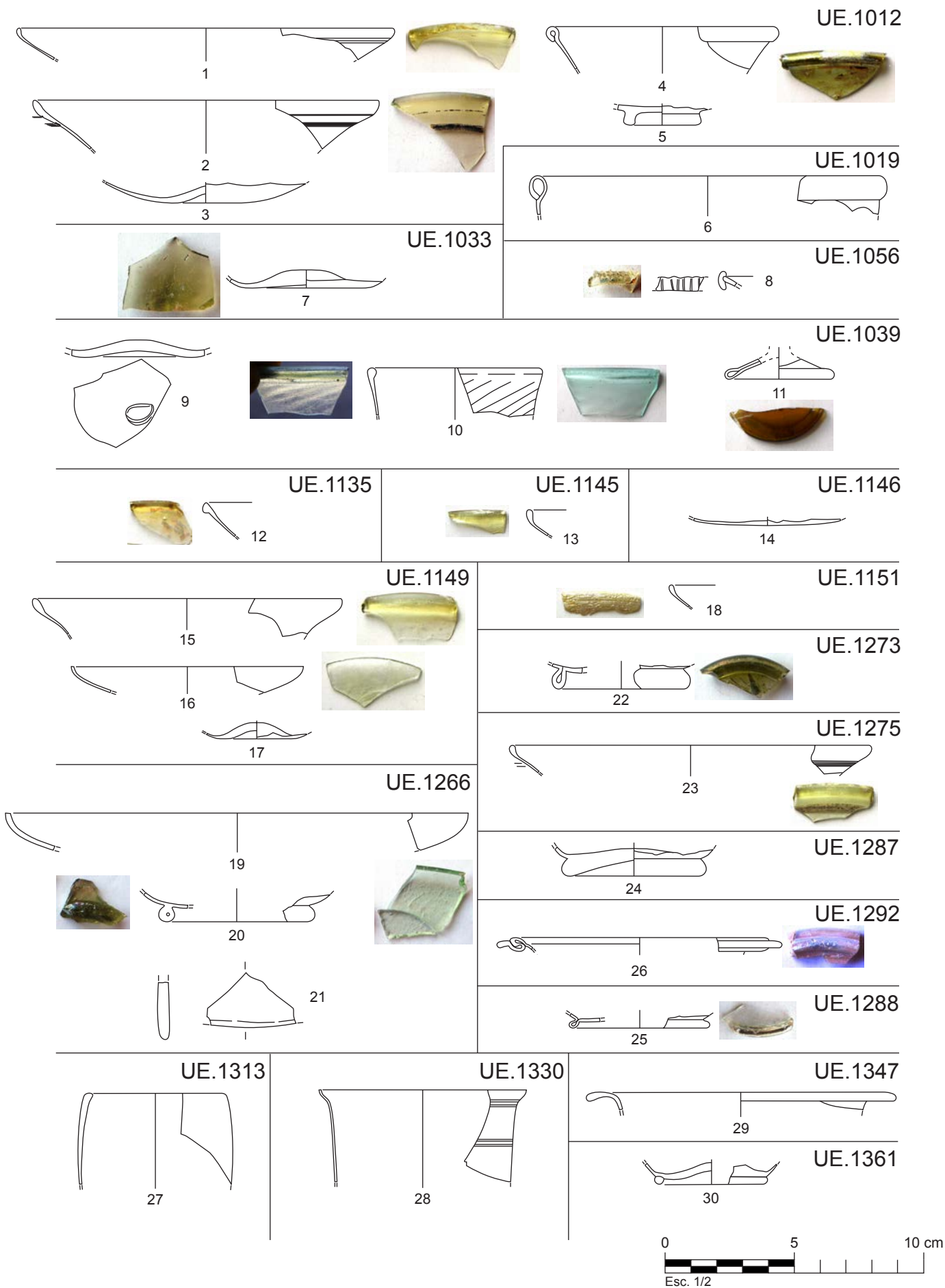

UE.101

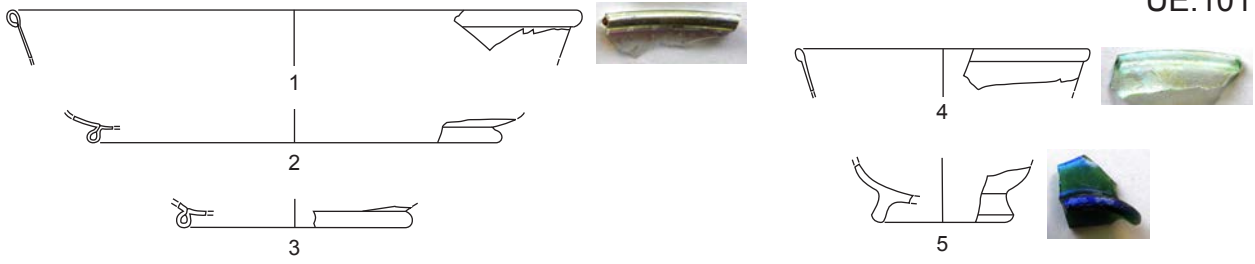

UE.105

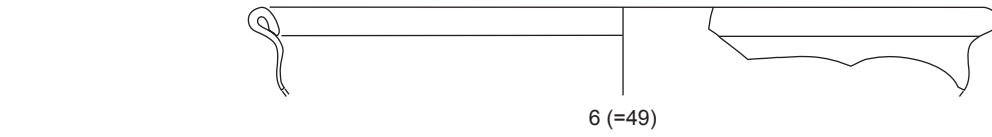

UE.108

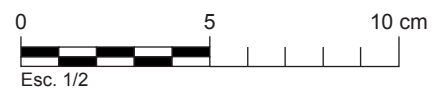
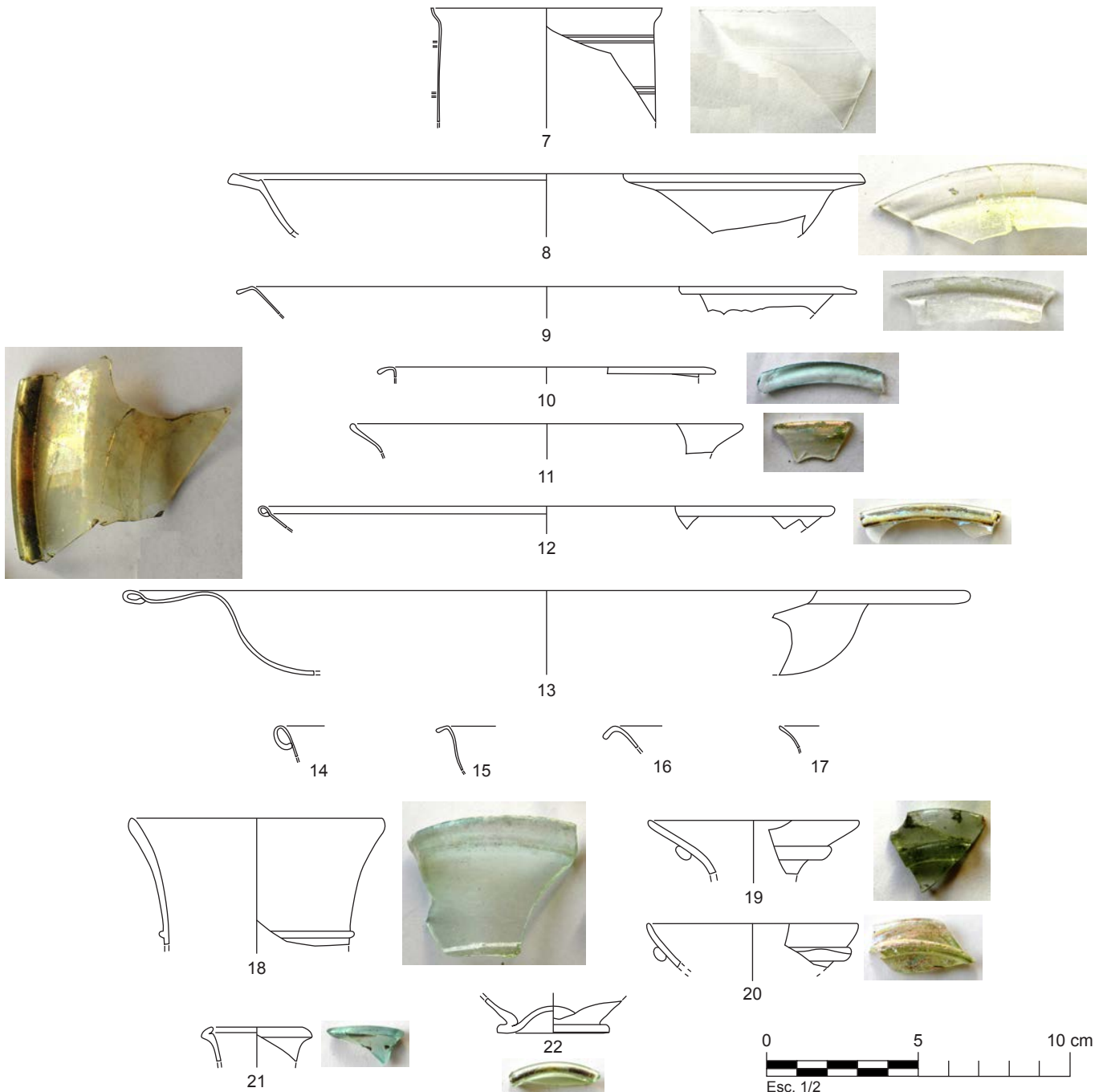

UE.109

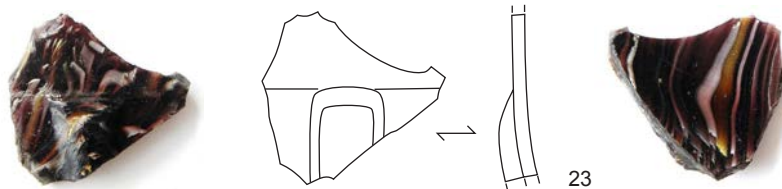

UE.123

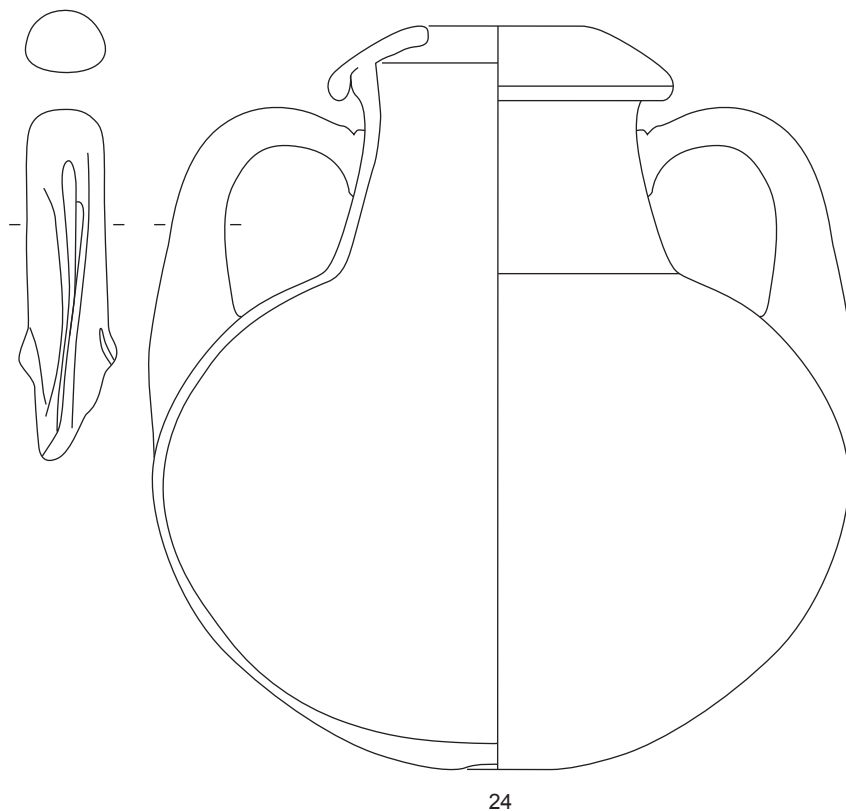

Fotografia J.-F. Clariana 2011, p.14, fig.9  
Escala 1/4

UE.124



UE.139

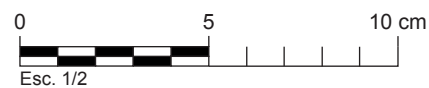
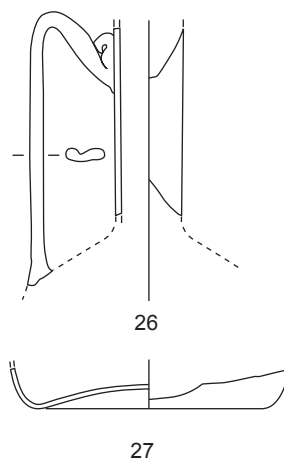

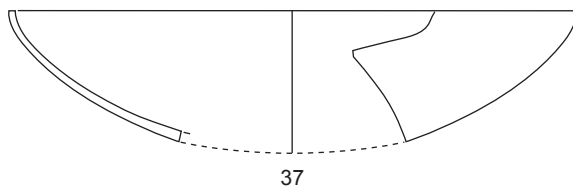
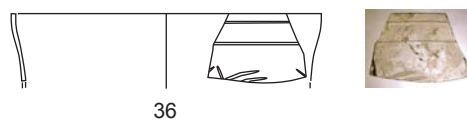
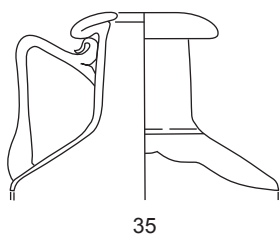
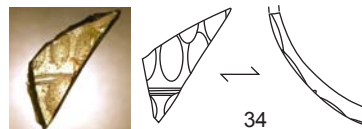
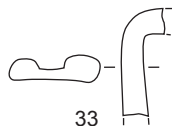
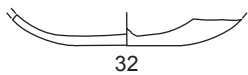
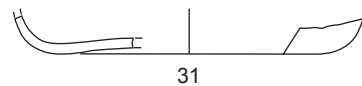
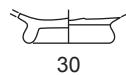
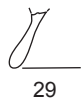
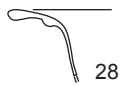

Detall del cap



Fotografia Museu de Mataró

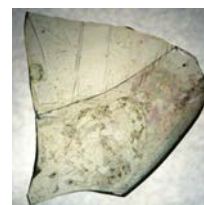

Detall del peu i la columna

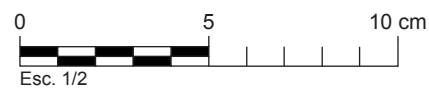



UE.151

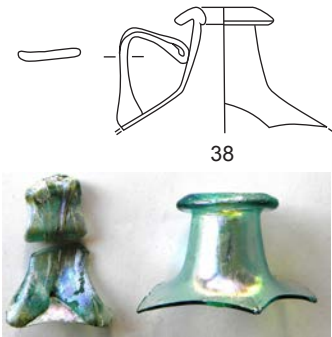

38

UE.155

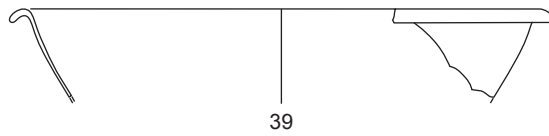

39

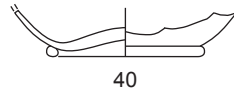

40

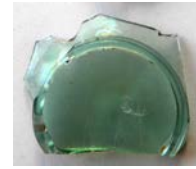

UE.157

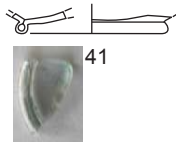

41

UE.167

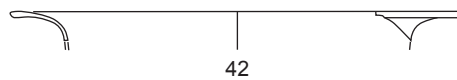

42



UE.177

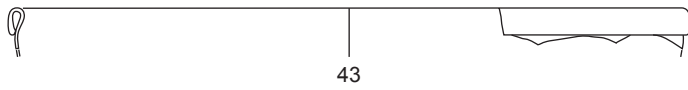

43

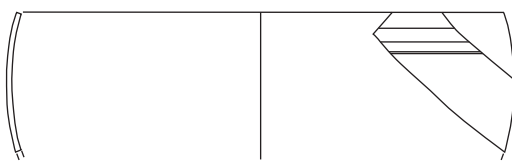

44

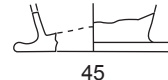

45



UE.181

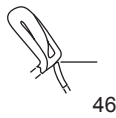

46

UE.194

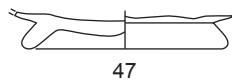

47



UE.198

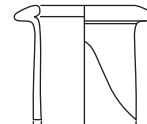

48



UE.200

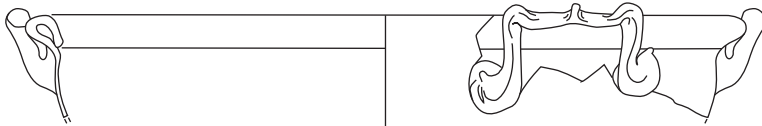

49 (=6)



50

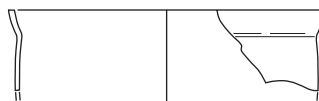

51



52

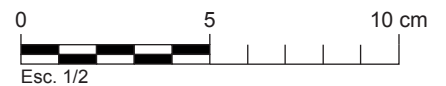

UE.213

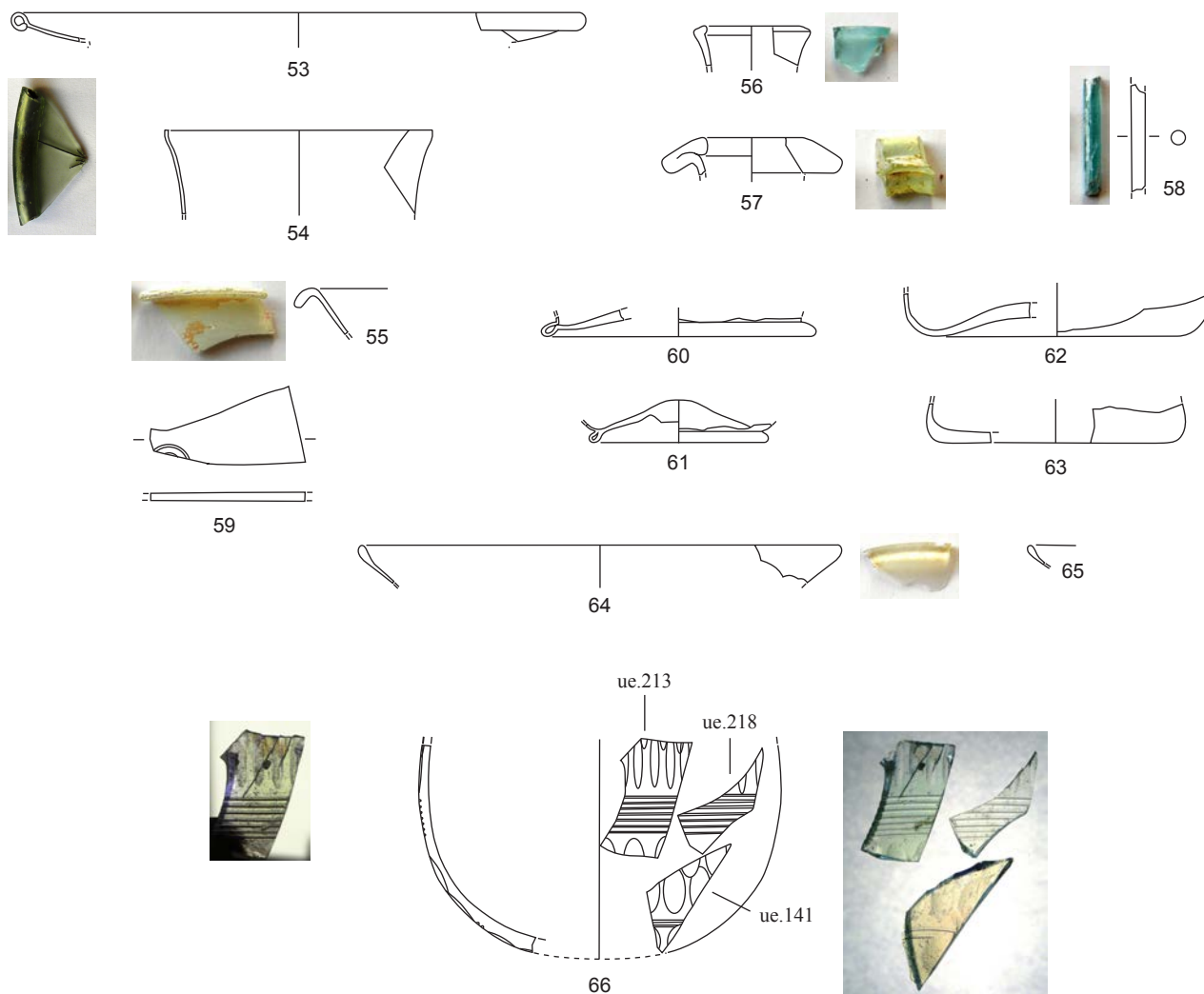

UE.215

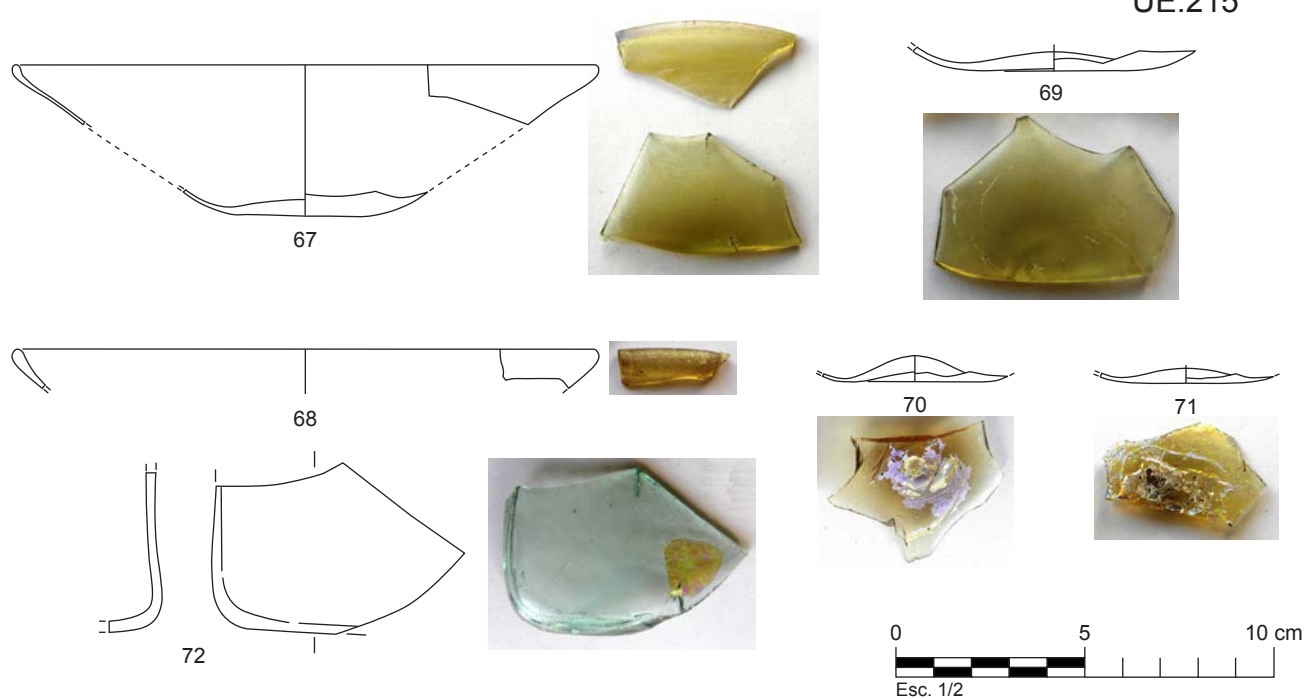

UE.218

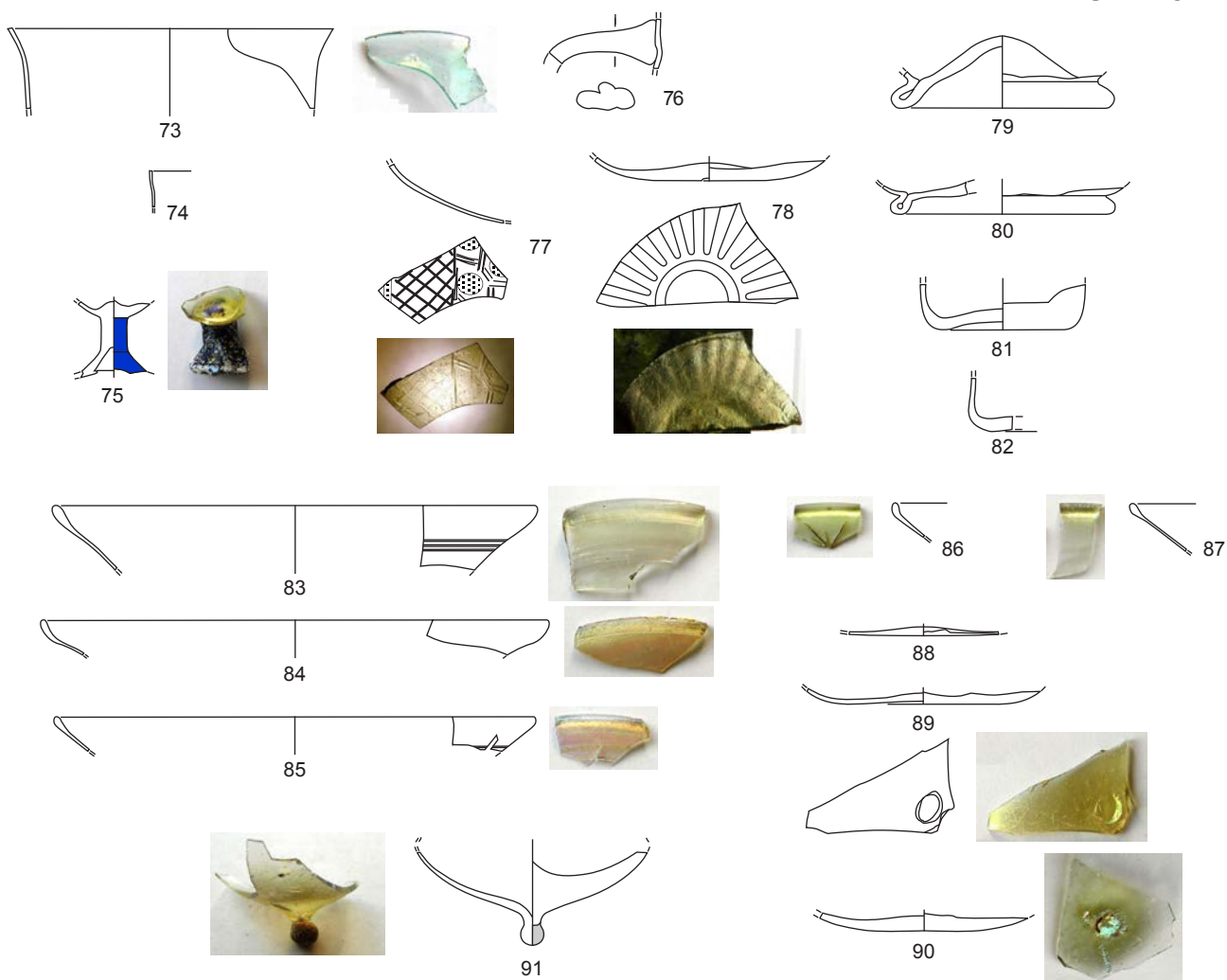

UE.220

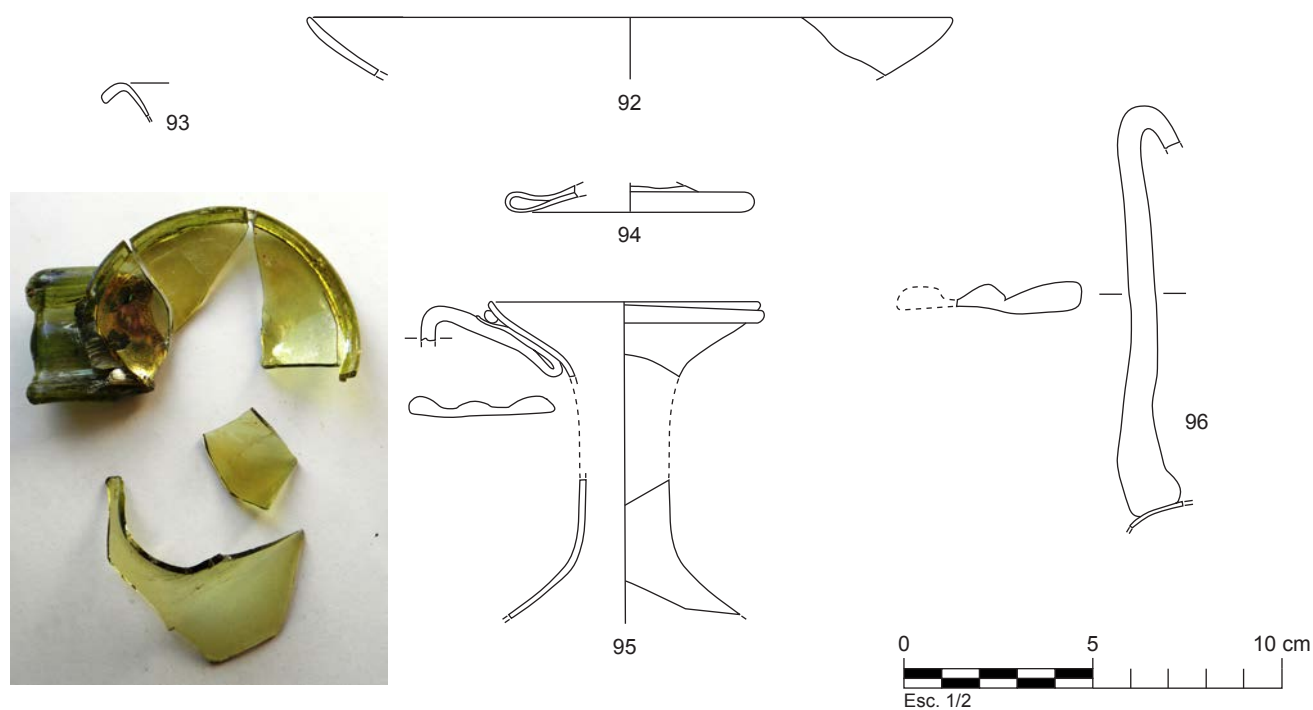

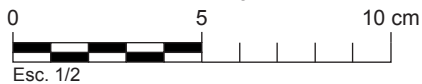
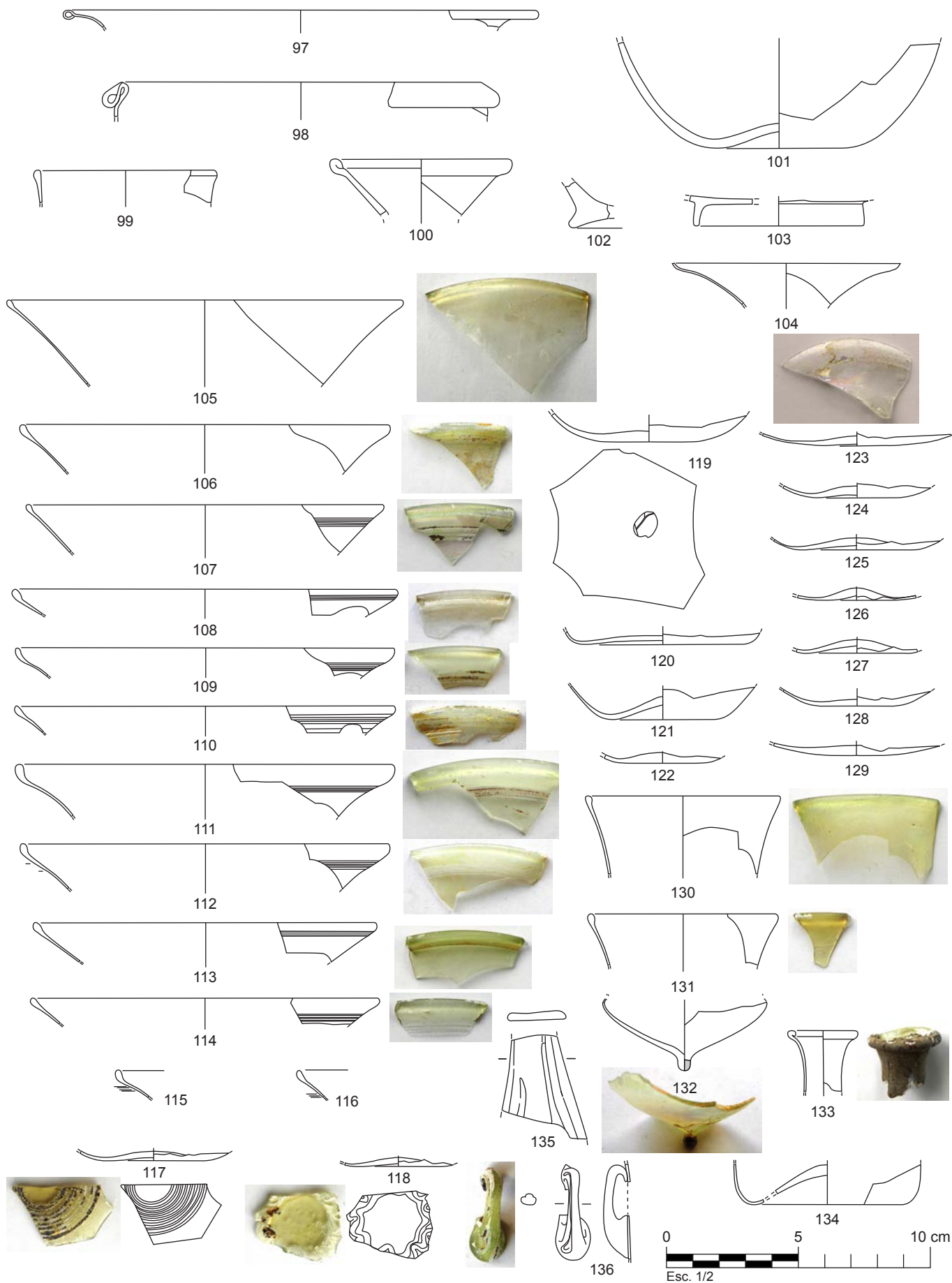

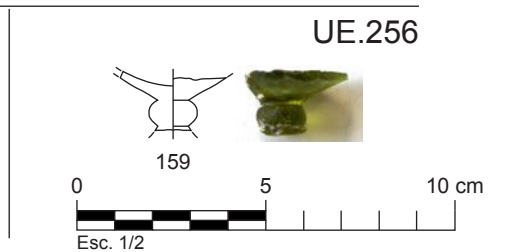
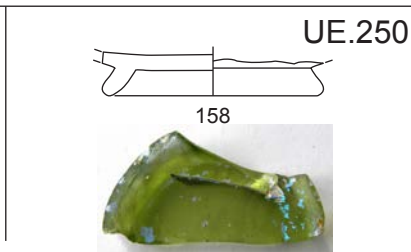
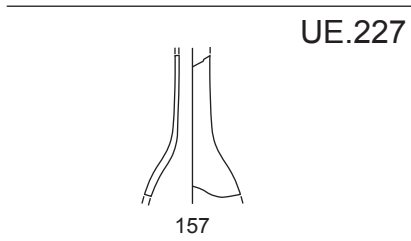
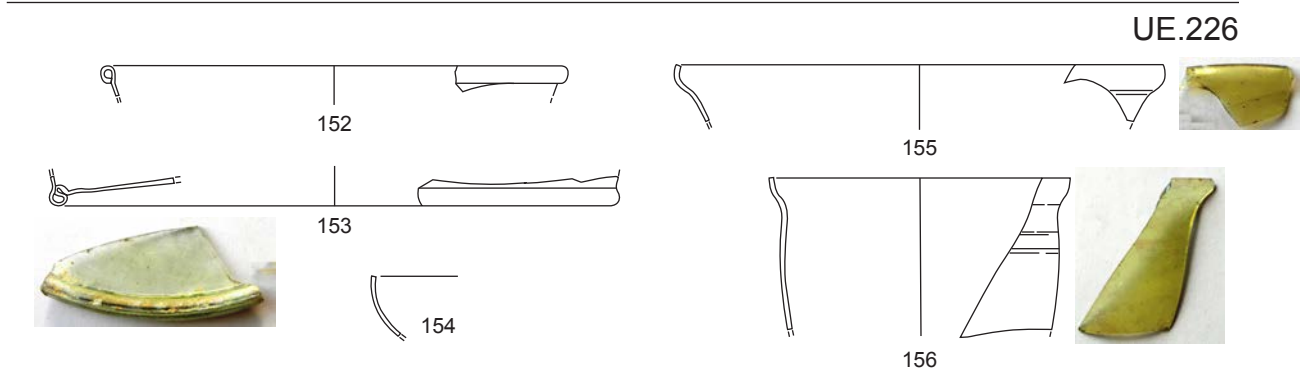
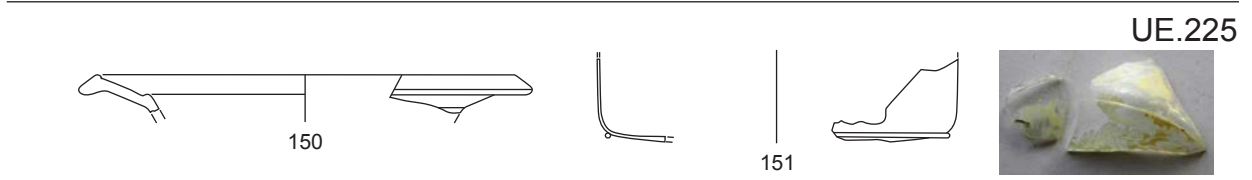
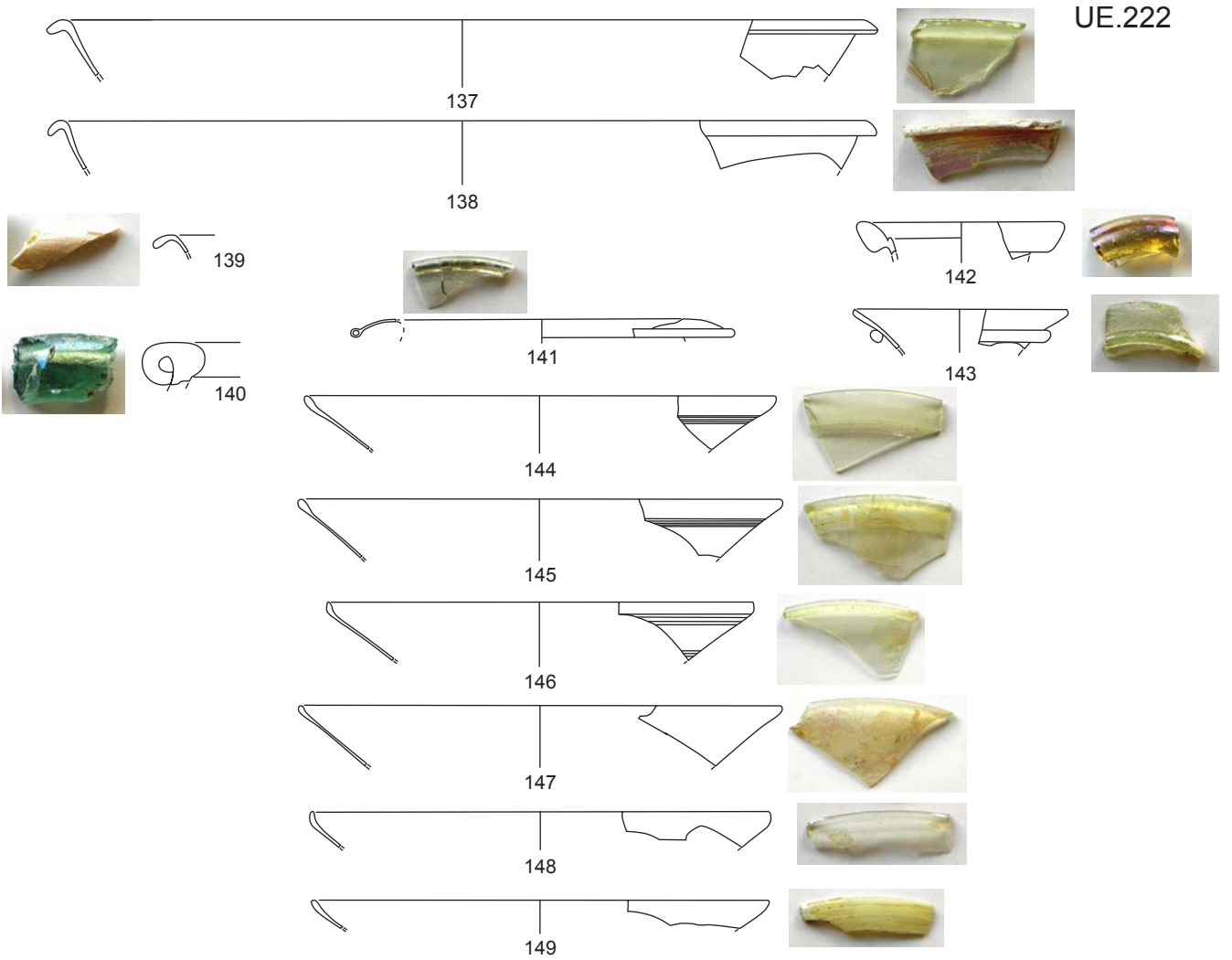

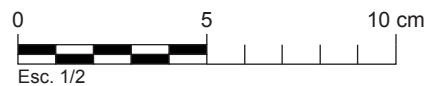
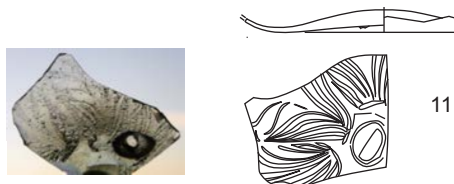
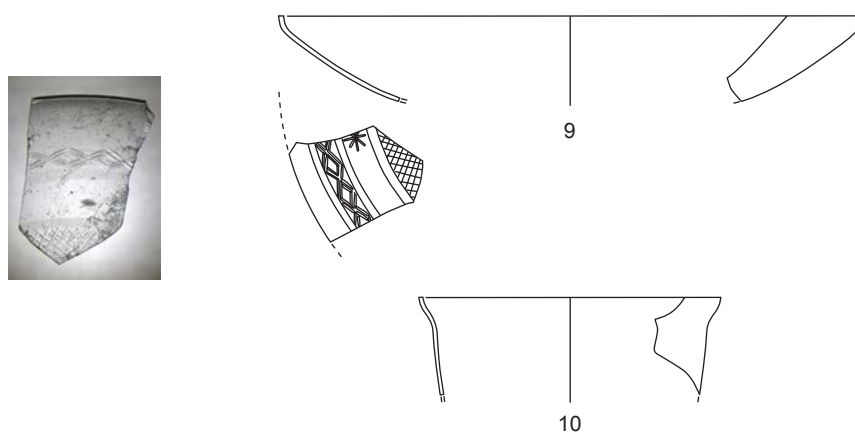
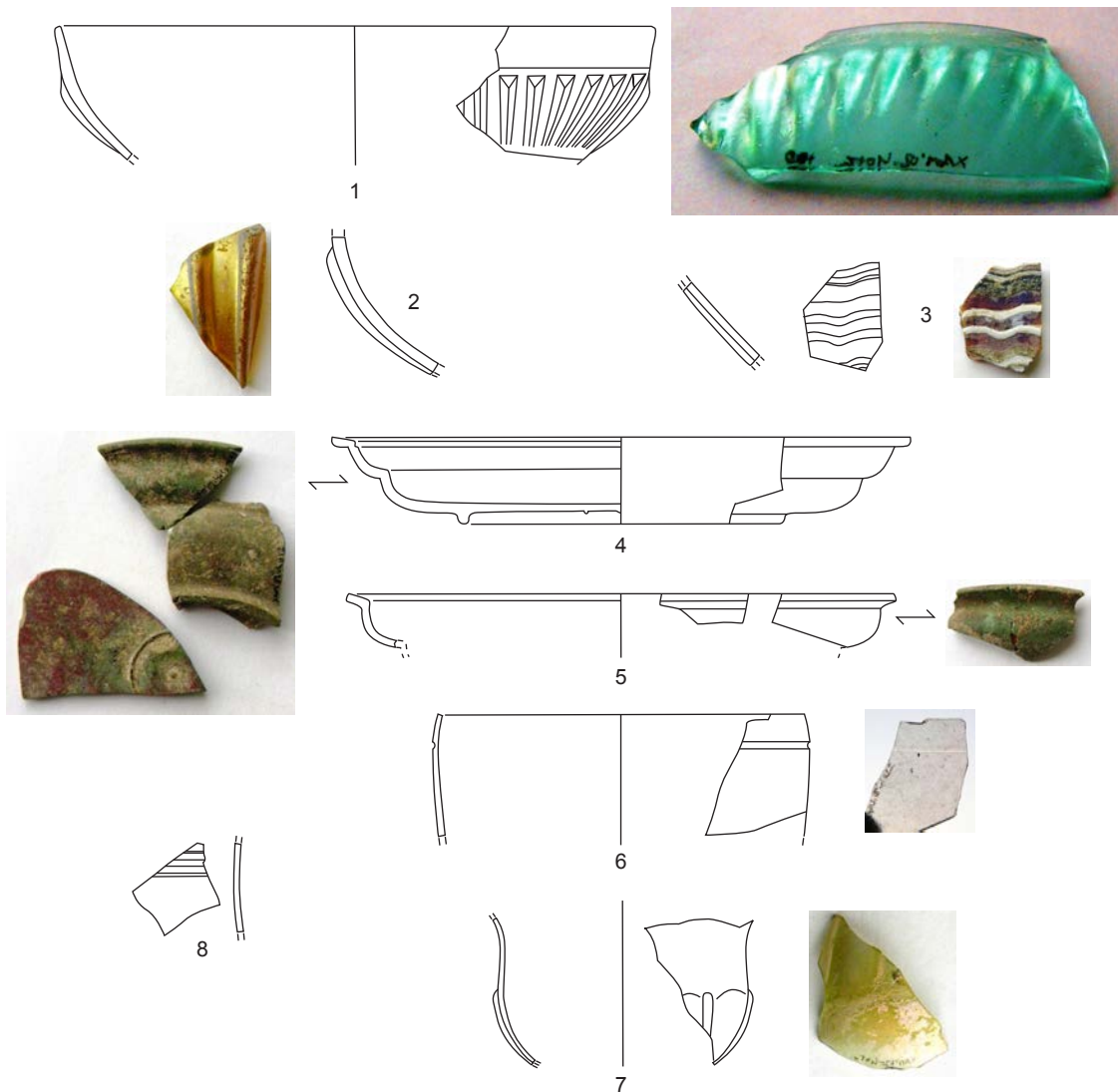

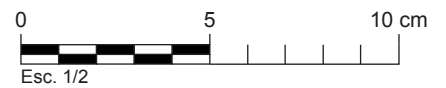
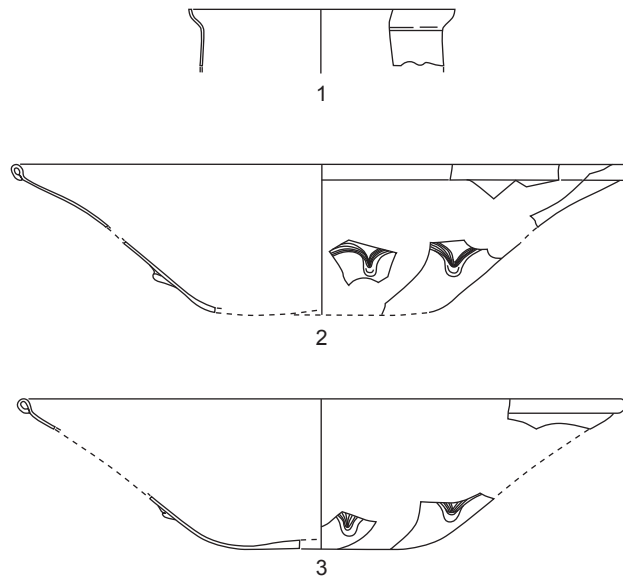
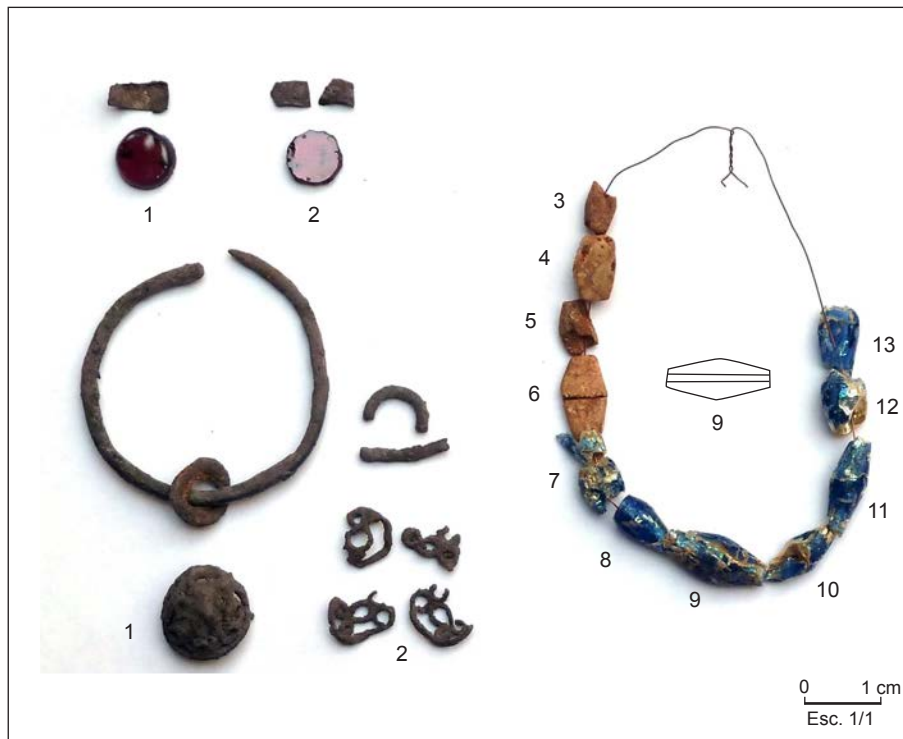

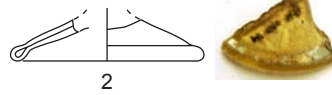
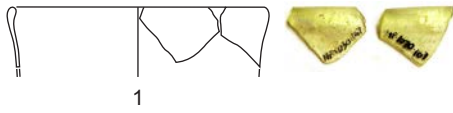

A2-UE.1053

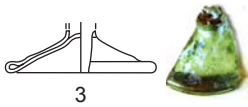

A2-UE.1070

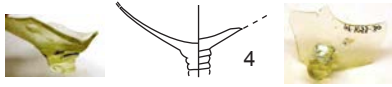
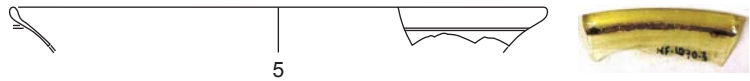

A2-UE.1073



A3-UE.1039



A3-UE.1049

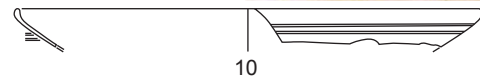
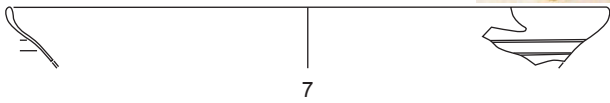

A3-UE.1040

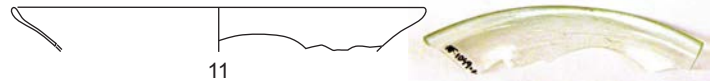

A3-UE.1046

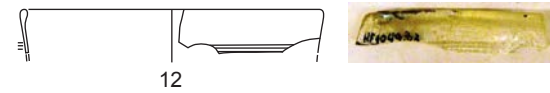

A5-UE.1169

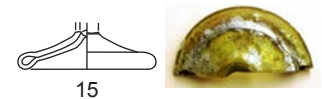
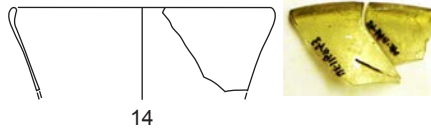
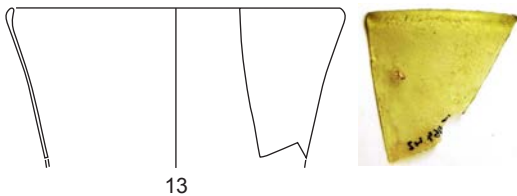

A5-UE.1177

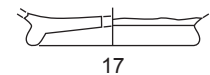

A6-UE.1067

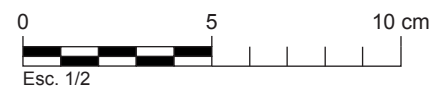
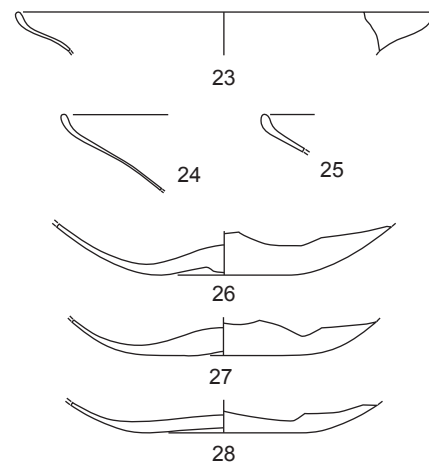
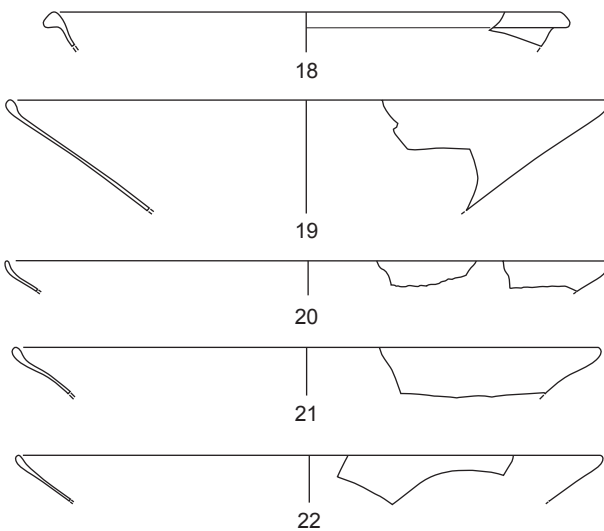



A6-UE.1068

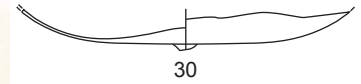
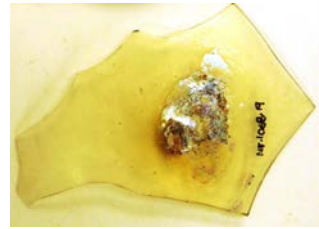
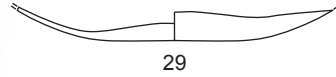

A7-UE.1066

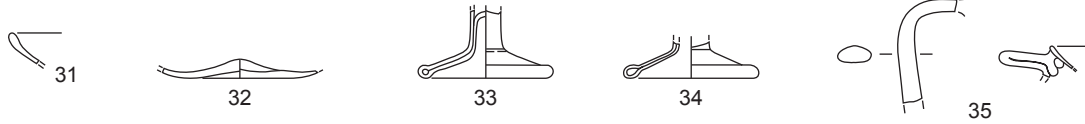

A8-UE.1132

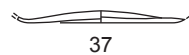
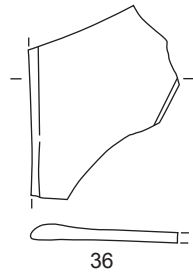

A8-UE.1152

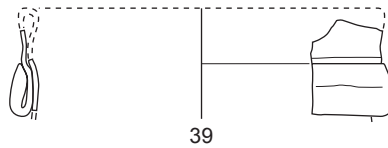

A8-UE.1153



A8-UE.1283



A9-UE.1077

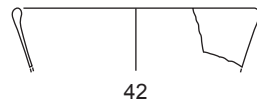

A9-UE.1178

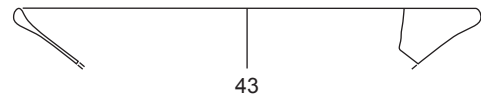

A9-UE.1780

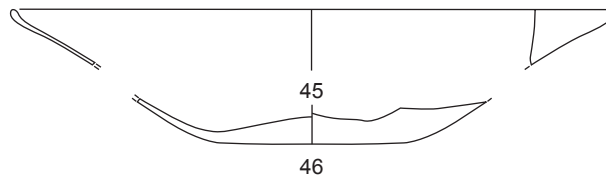

A9-UE.1806



A9-UE.1786



A10-UE.1114

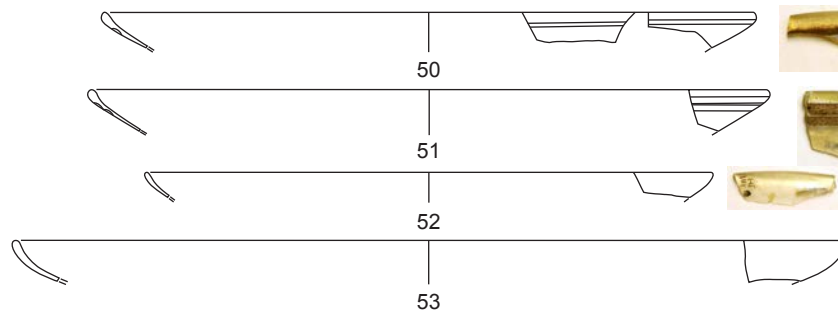

A10-UE.1232

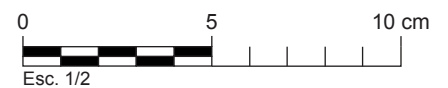

A11-UE.1100



A11-UE.1105

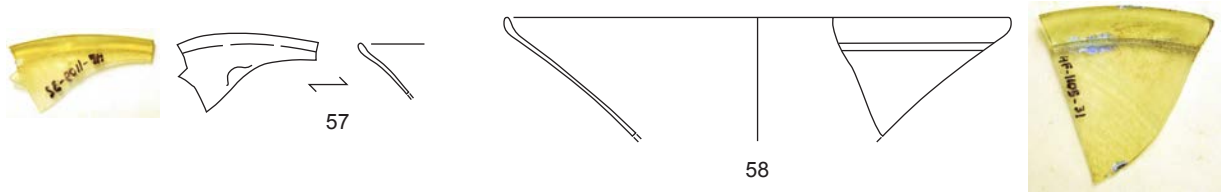

A11-UE.1111

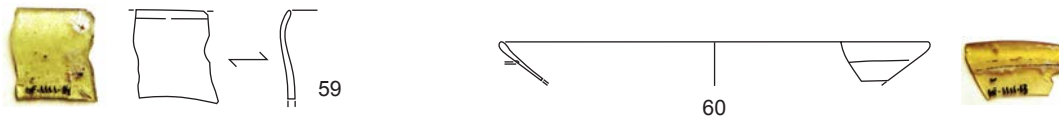

A12-UE.1121

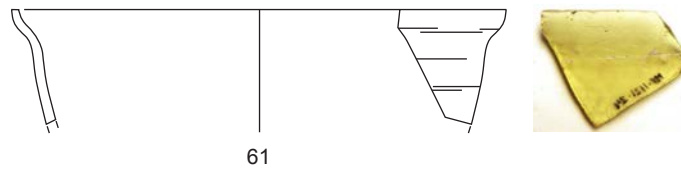

A15-UE.1054

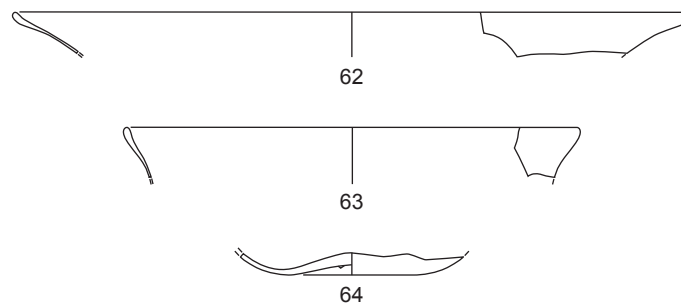

A15-UE.1055

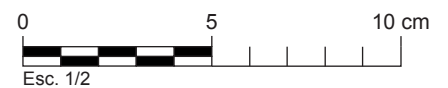
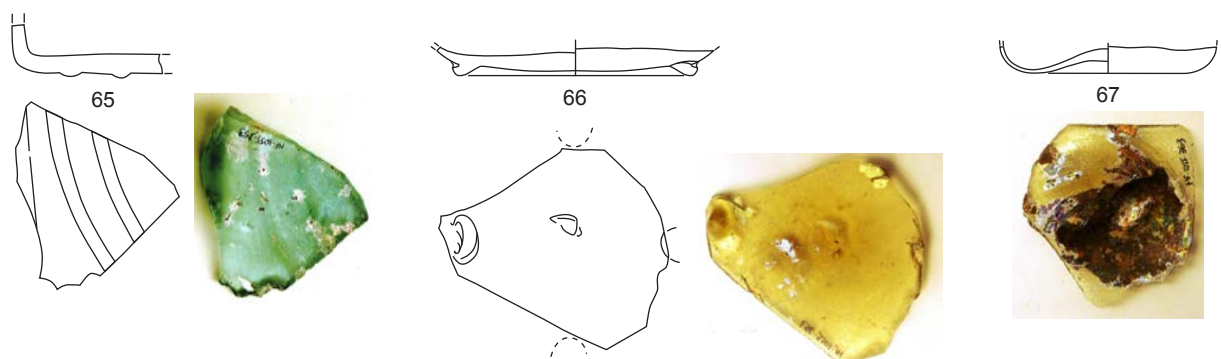

A15-UE.1055

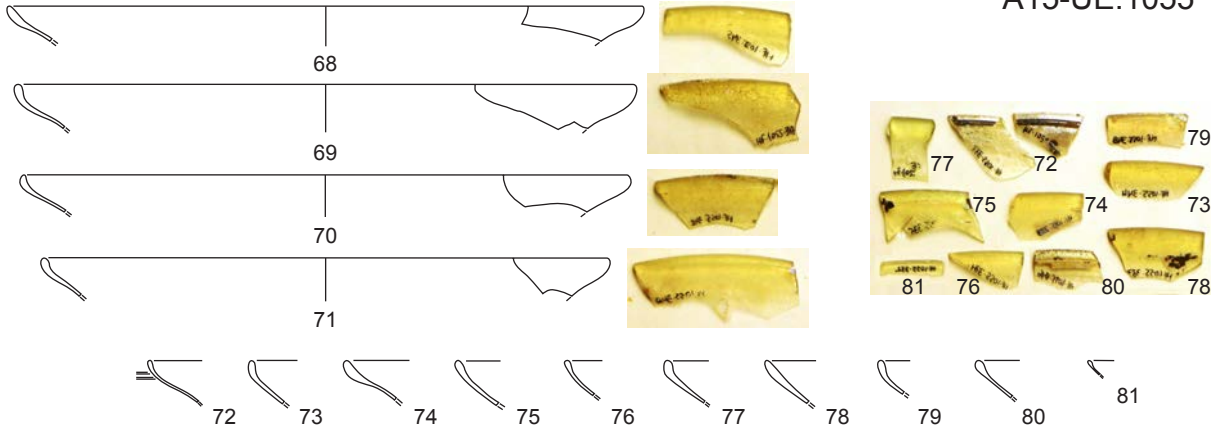

A15-UE.1056

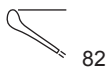

82

A15-UE.1057

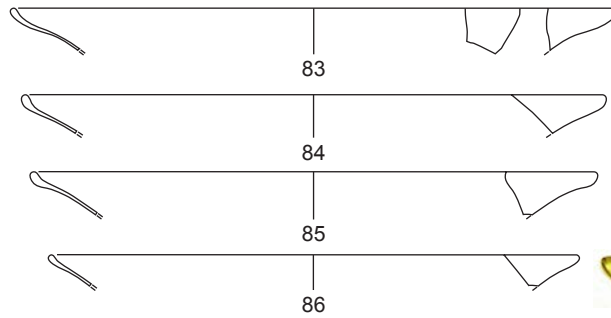

83

84

85

86



A15-UE.1294

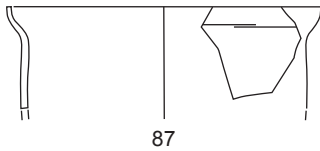

87

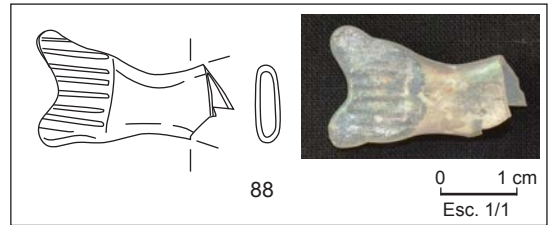

88

0 1 cm  
Esc. 1/1

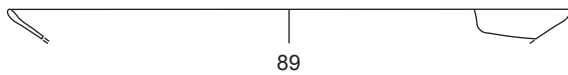

89

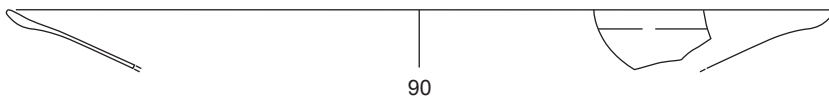

90

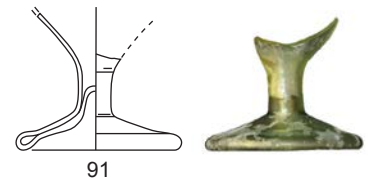

91

A15-UE.1295

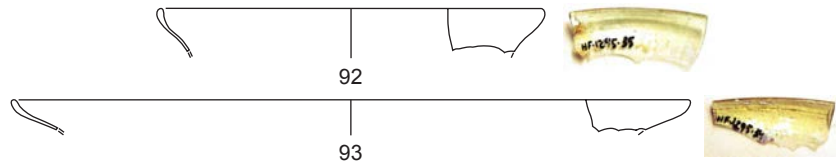

92

93

A15-UE.1303



94

A15-UE.1323



95

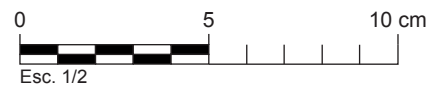

A15-UE.1310

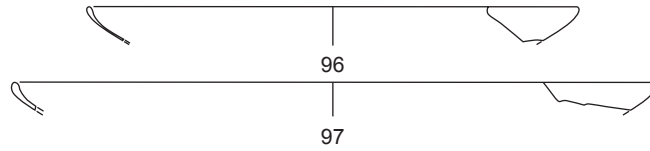

A15-UE.1351

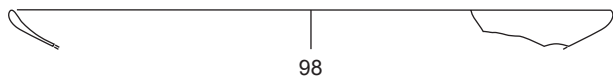

A15-UE.1374



A15-UE.1361

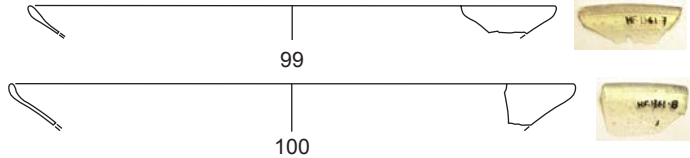

A15-UE.1376

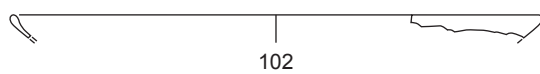

A15-UE.1377



A15-UE.1378

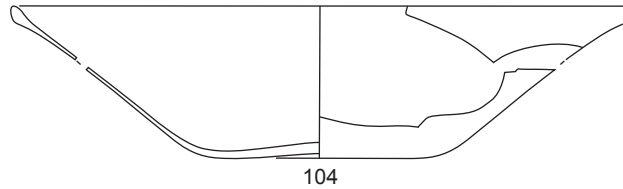

A15-UE.1400

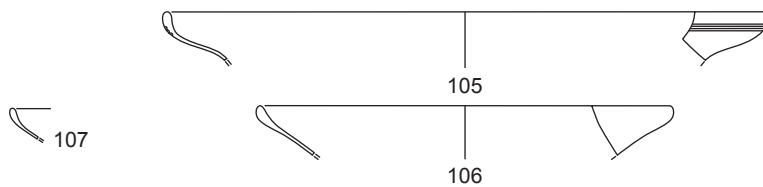

A15-UE.1415

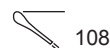

A16-UE.1202



A17-UE.1211

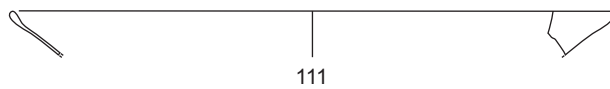

A17-UE.1218

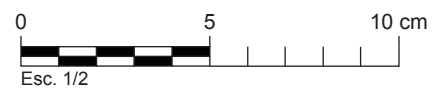
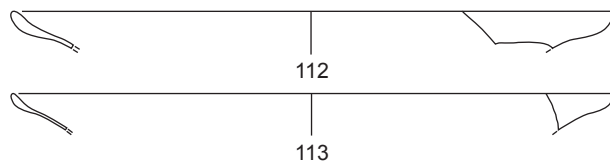

A23-UE.1124

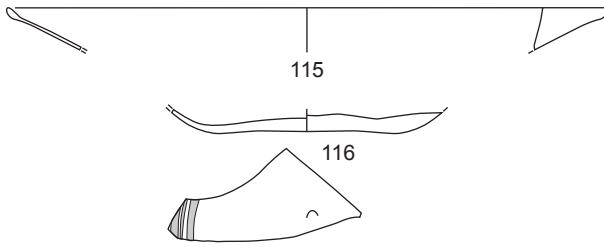

A23-UE.1434



A23-UE.1447



A23-UE.1448

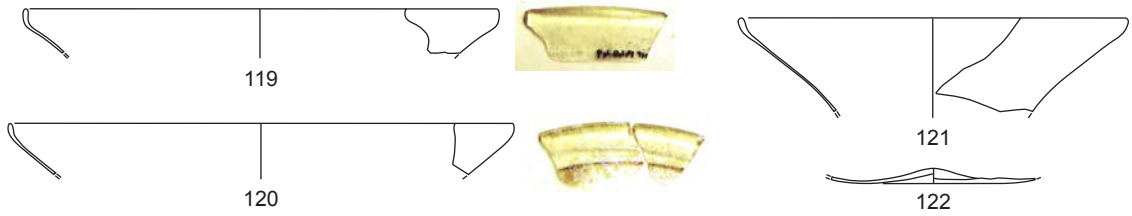

A23-UE.1458

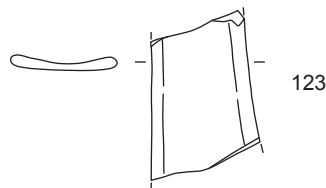

Sector NO-UE.1444

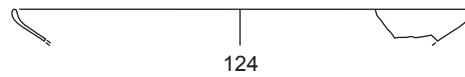

Sector SO-UE.1450



Superficial-UE.1027



Superficial-UE.1028

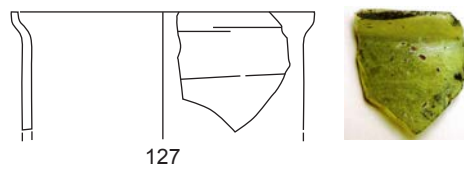

Sense Context-UE.4000

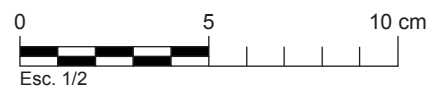
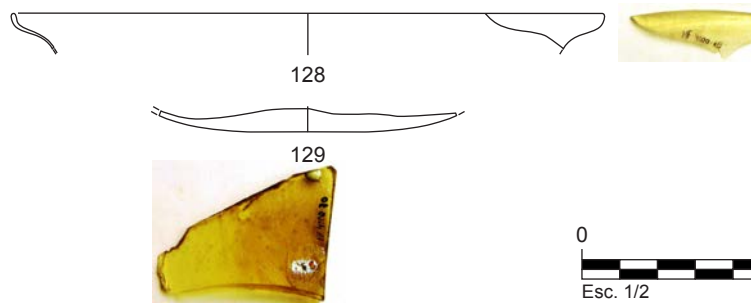

UE.63

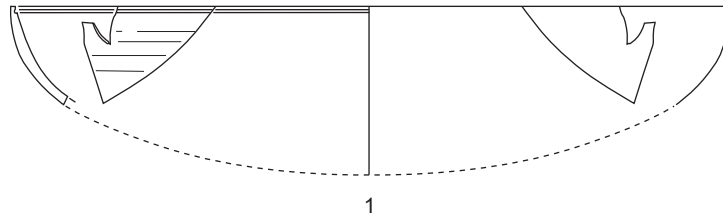

UE.176

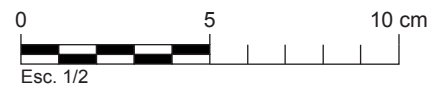
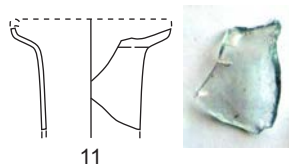
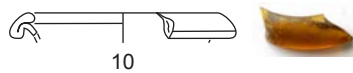
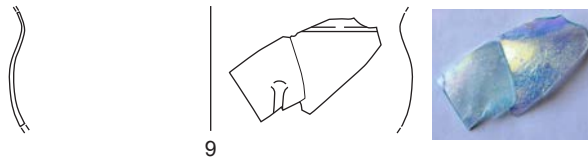
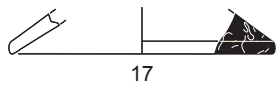
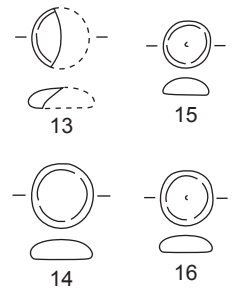
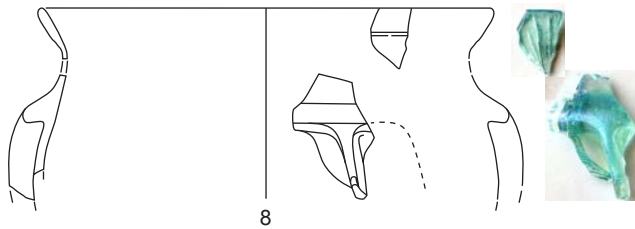
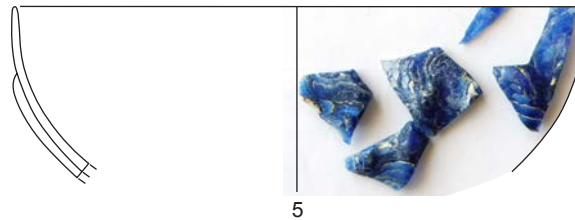
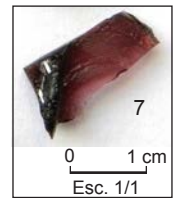
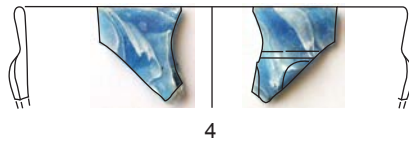
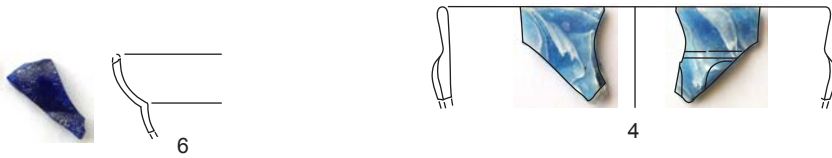
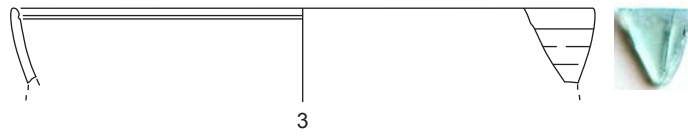
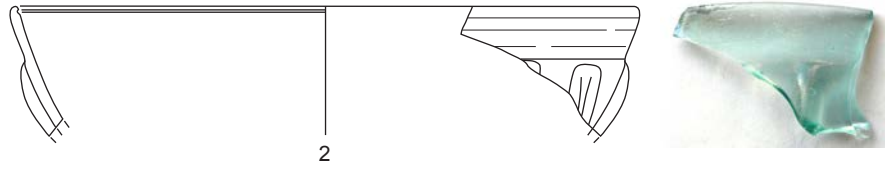

UE.76

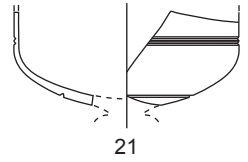
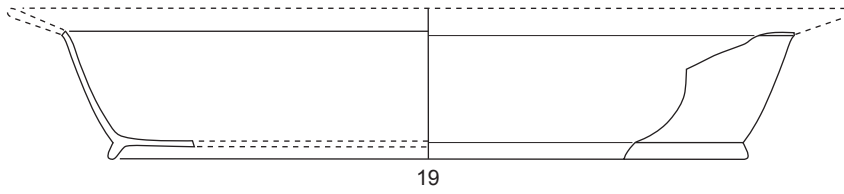
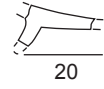
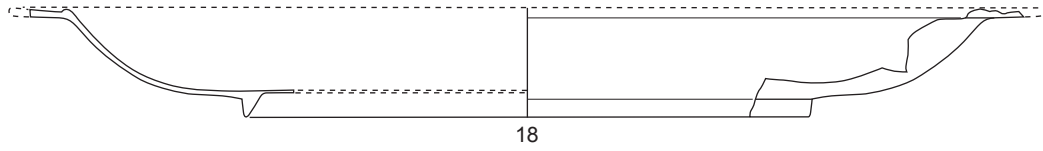

UE.16

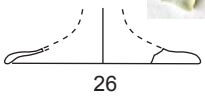
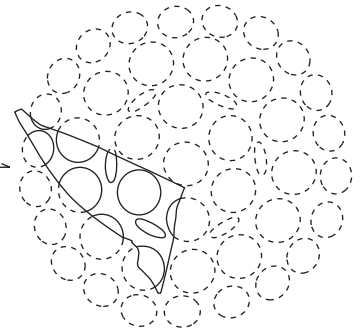
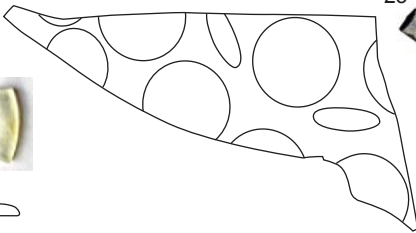
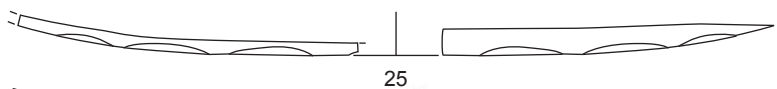
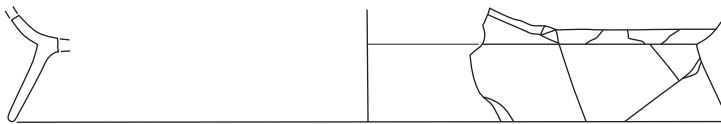
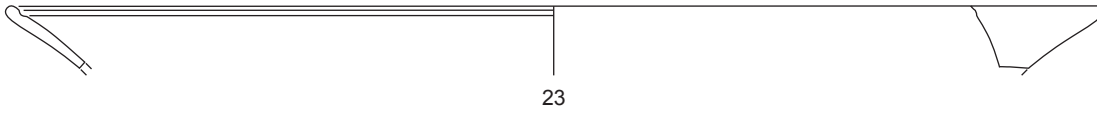
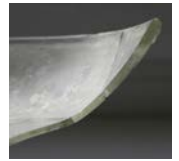
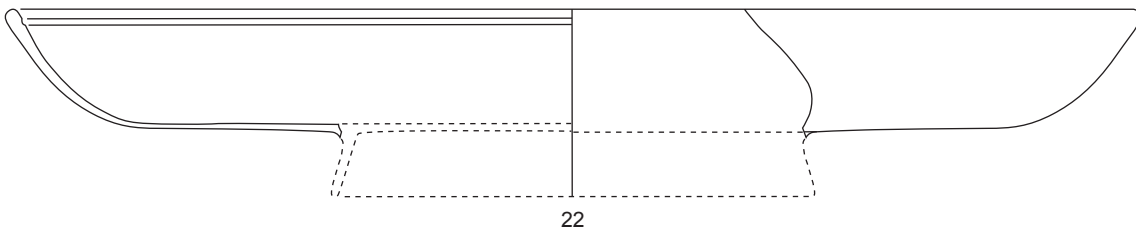

UE.18

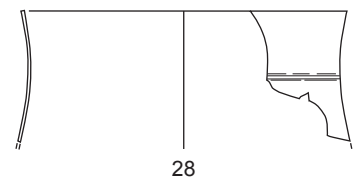
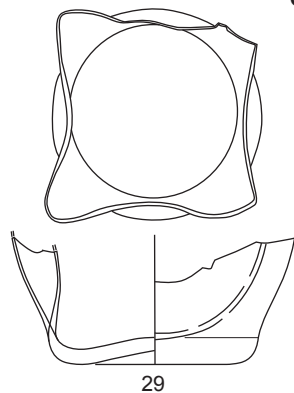
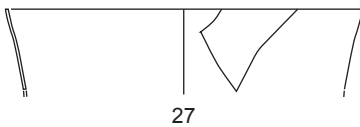

UE.15

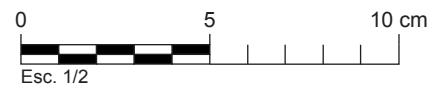
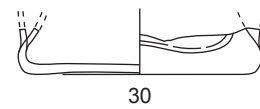



UE.511

1

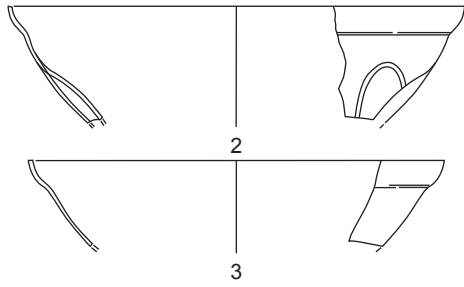

UE.512

2

3

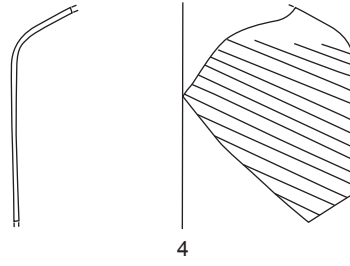

4

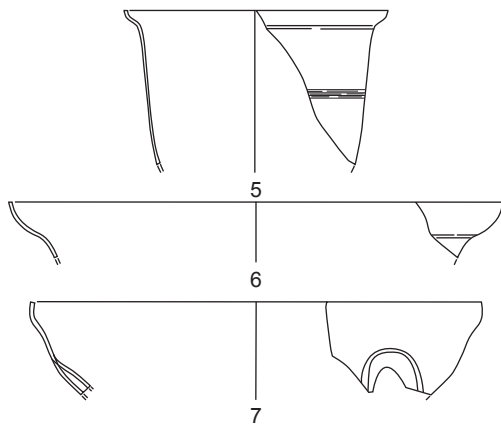

UE.11001

5

6

7

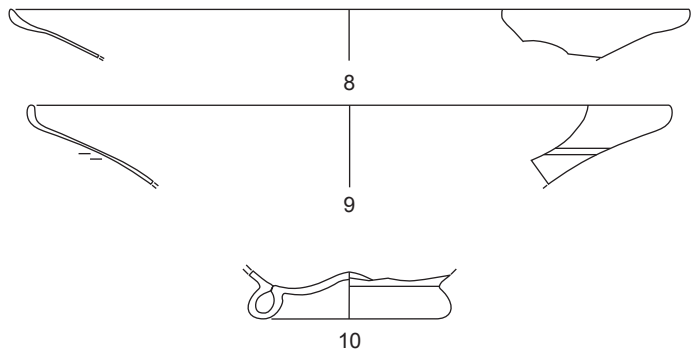

8

9

10

UE.11030

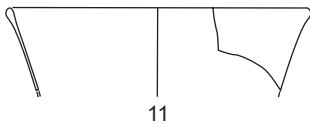

11

UE.11046

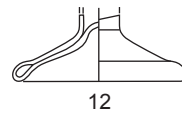

12

UE.11048

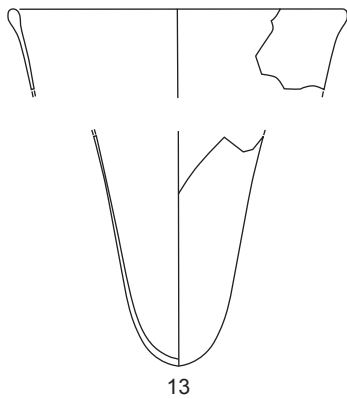

13

UE.11054

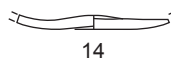

14

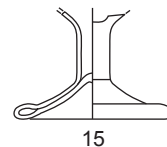

15

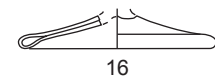

16

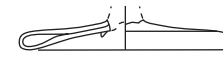

17

UE.11063



18



19

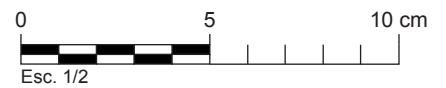



UE.11070

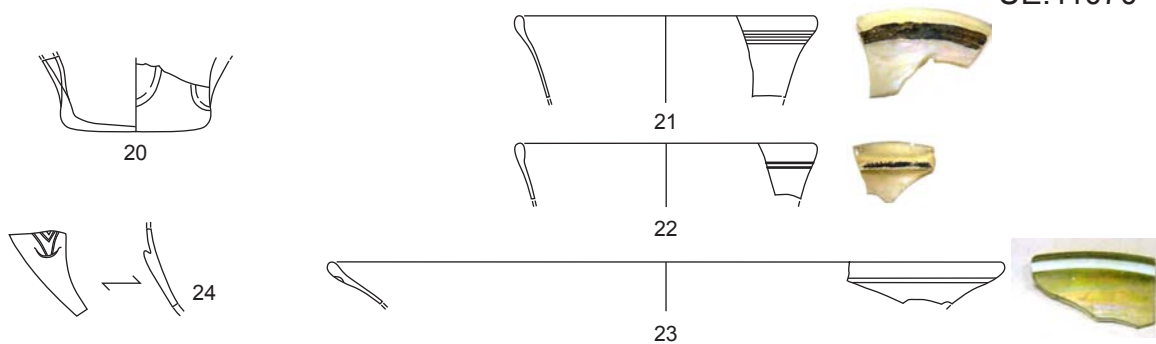

UE.11073

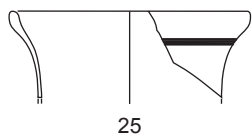

25

UE.11090



29

UE.11074

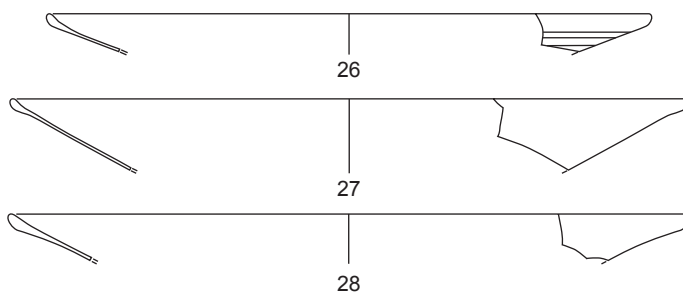

26

27

28

UE.12030

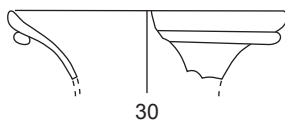

30

UE.12034

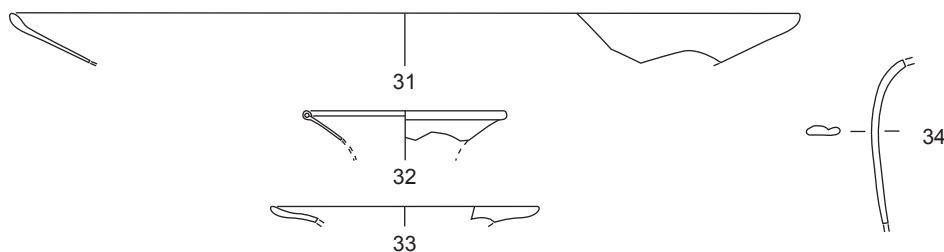

31

32

33

34

UE.12037



35

UE.12038

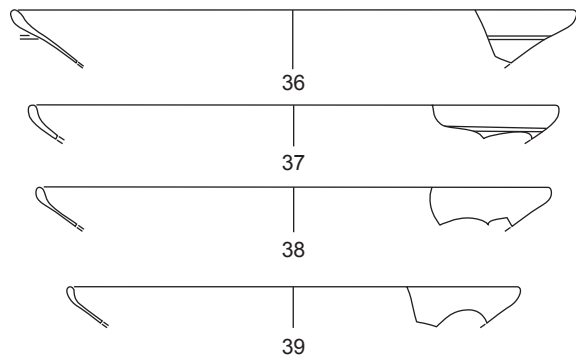

36

37

38

39

UE.12040

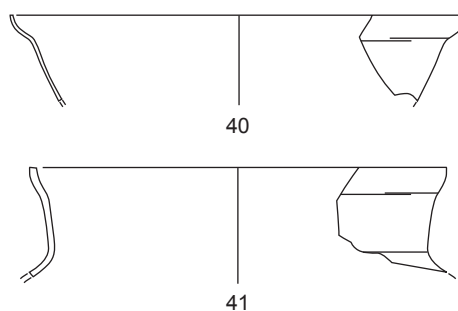

40

41

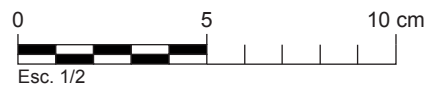

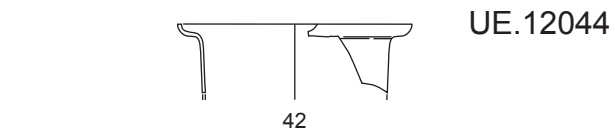

UE.12044

42

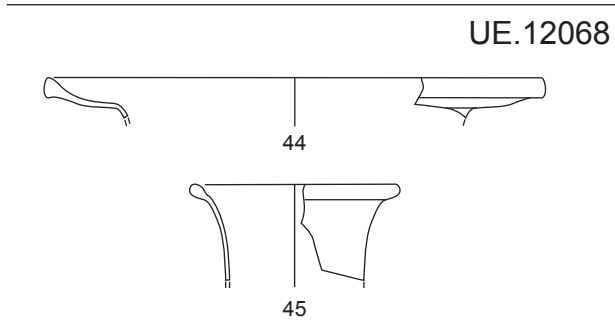

UE.12068

44

45



UE.12052

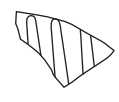

43

Staalische Kunstsammlungen Kassel  
Antike Gläser 1967- N° 98

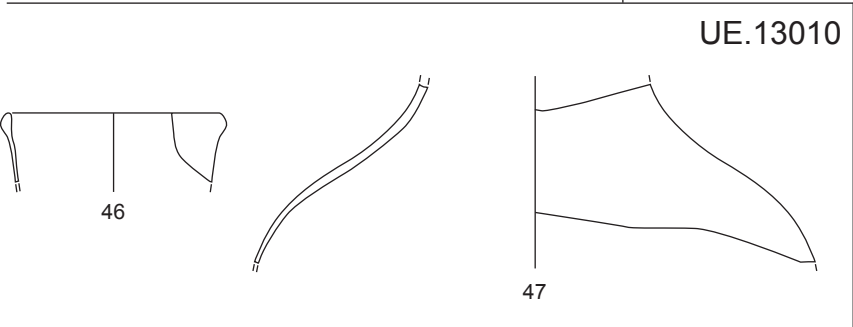

UE.13010

46

47

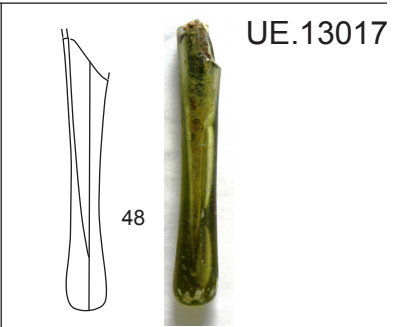

UE.13017

48



UE.14016

49

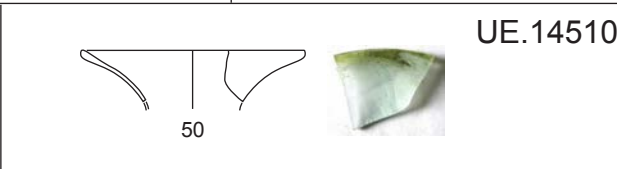

UE.14510

50

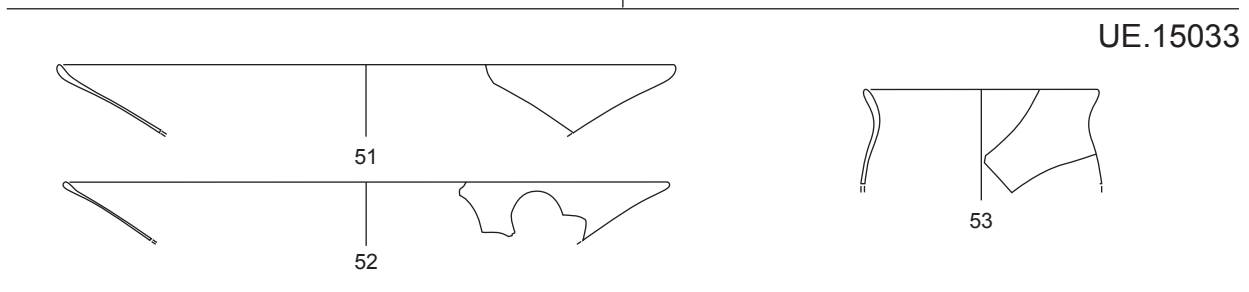

UE.15033

51

52

53

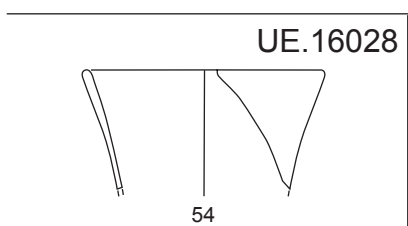

UE.16028

54

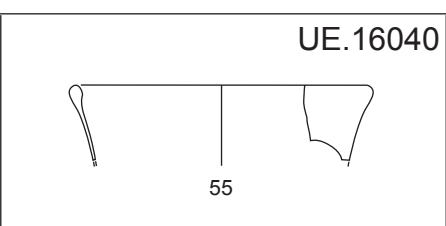

UE.16040

55

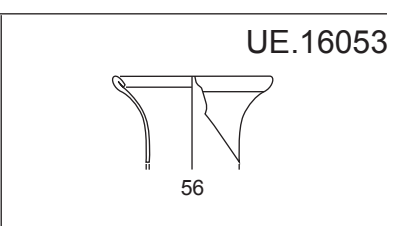

UE.16053

56

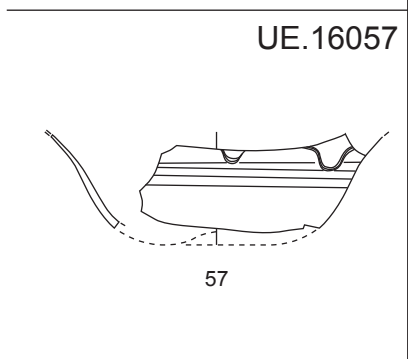

UE.16057

57

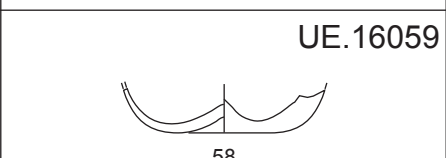

UE.16059

58

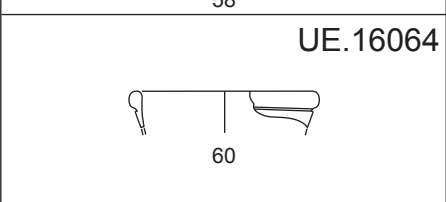

UE.16064

60

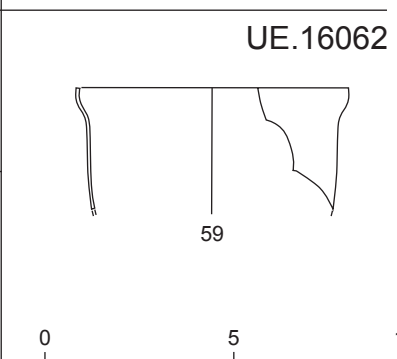

UE.16062

59

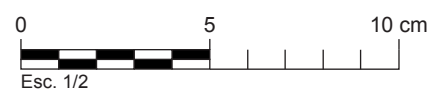

UE.18022

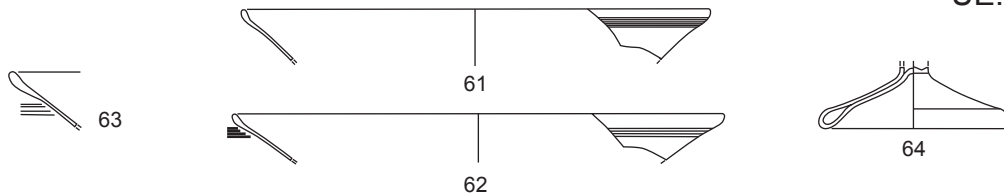

UE.18032

UE.18037

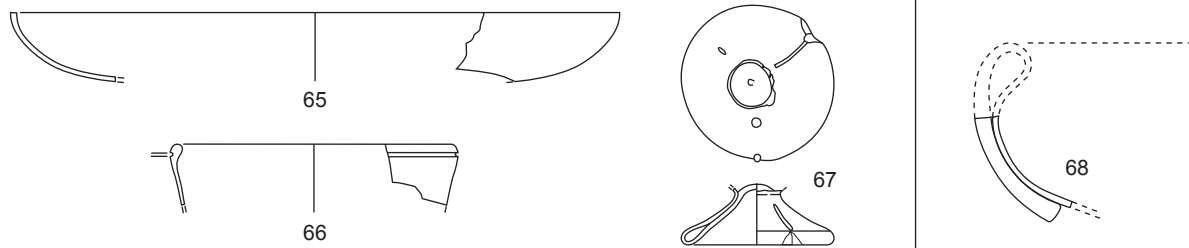

UE.18039

UE.18040

UE.18041

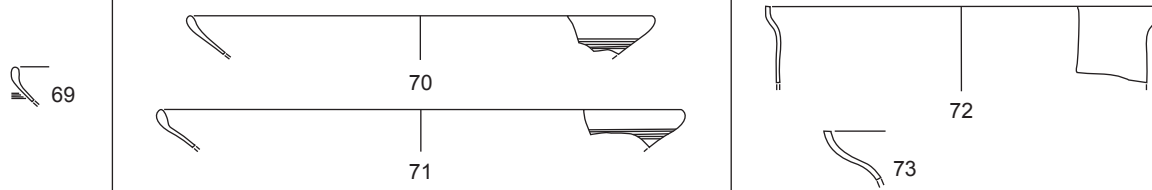

UE.19017



UE.19022

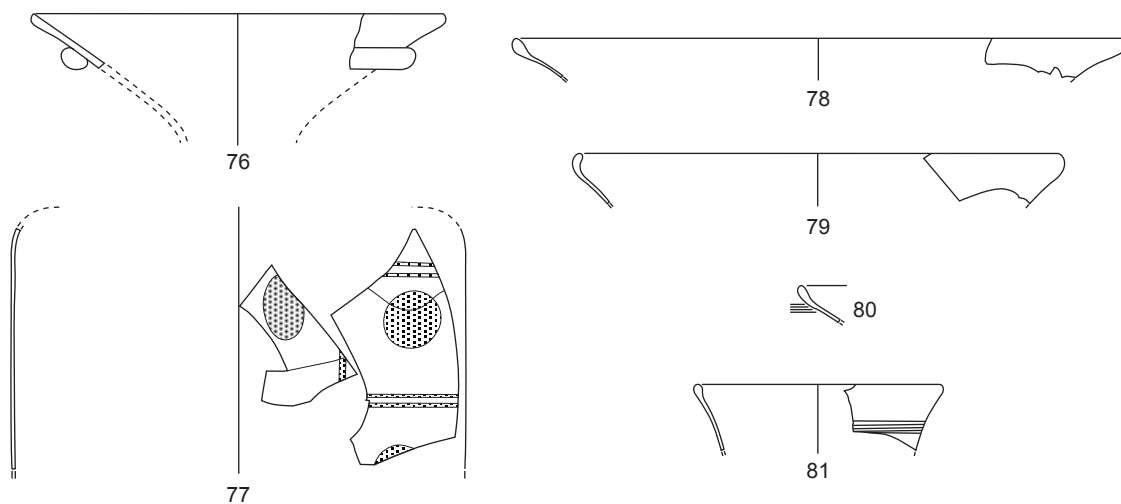

UE.19023

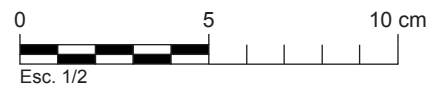

UE.21825

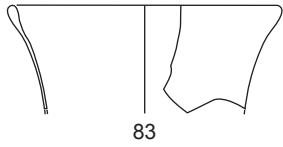

83

UE.21827

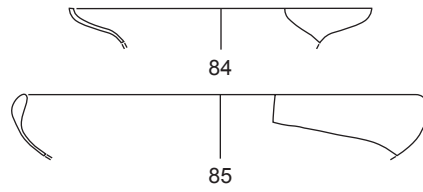

84

85

UE.21841

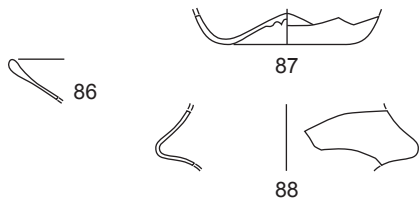

86

87

88

UE.21845

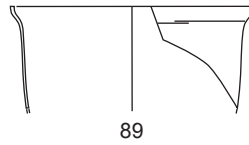

89

UE.21847

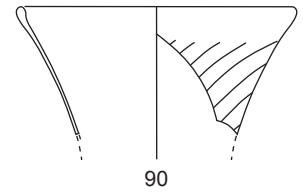

90

UE.23013

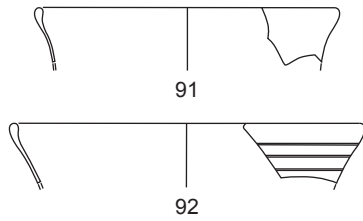

91

92

UE.23019

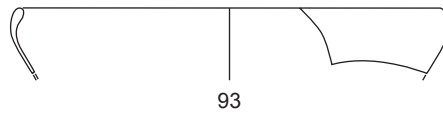

93

UE.23029

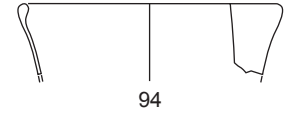

94

UE.23072

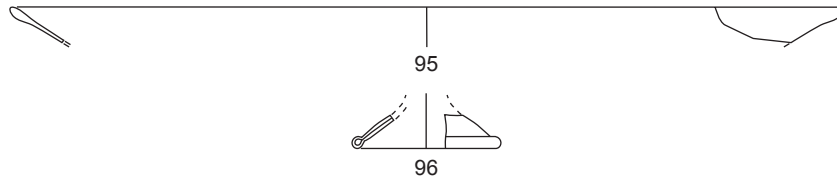

95

96

UE.23076

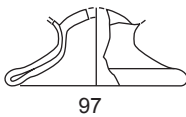

97

UE.23078

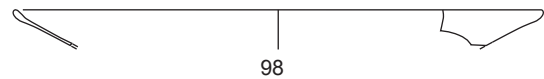

98

UE.23087

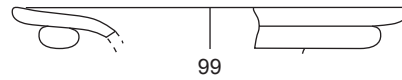

99

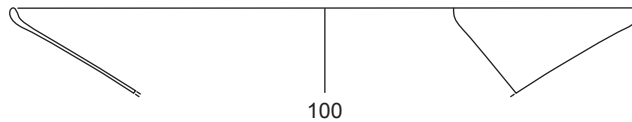

100

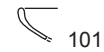

101

UE.23098

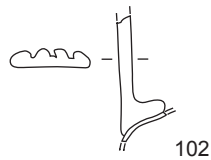

102

UE.23102



103

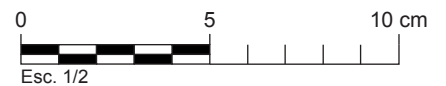

UE.24015

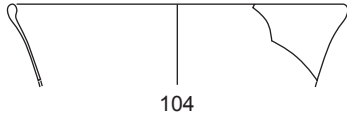

104



UE.24049

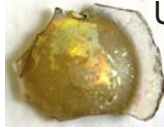

105

UE.24051

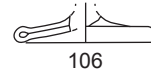

106



UE.24052

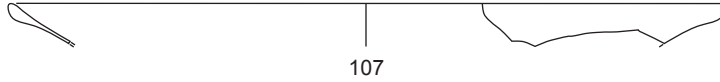

107

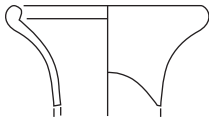

109

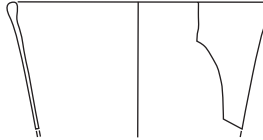

108

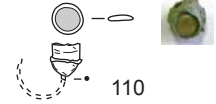

110

UE.24058

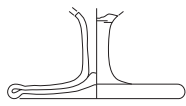

111



UE.24059

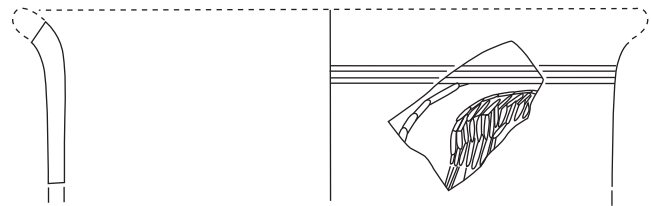

112



0 1 cm  
Esc. 1/1

UE.25063



113



UE.25066



114

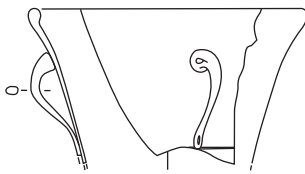

115

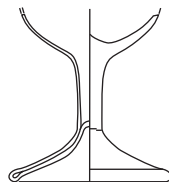

116



0 5 10 cm  
Esc. 1/2

UE.25070

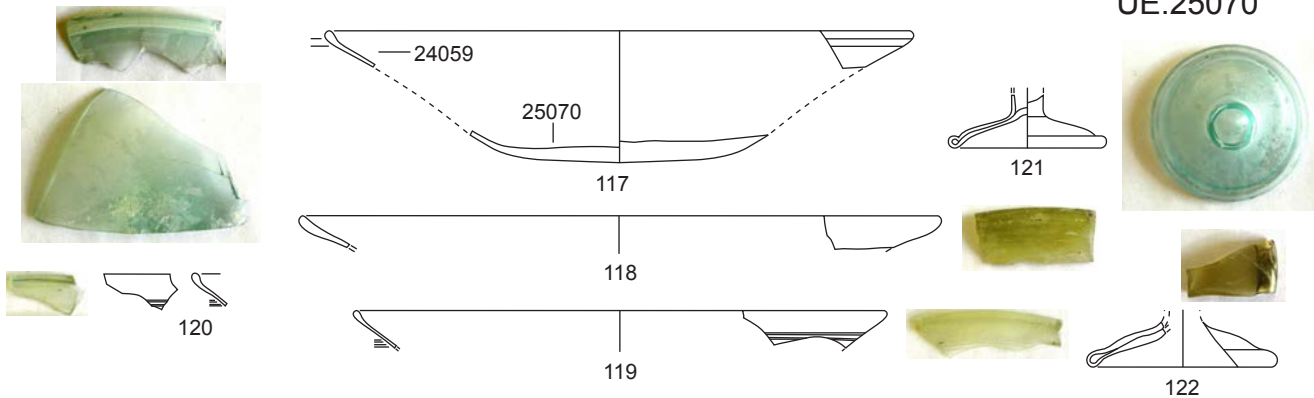

UE.25080

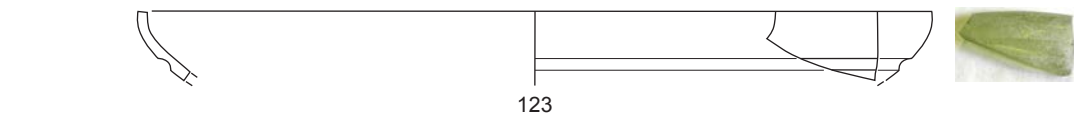

UE.25082

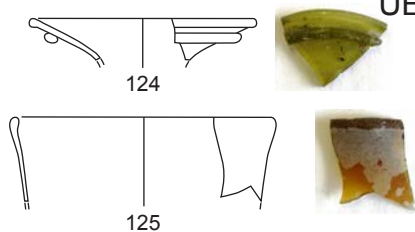

UE.25084

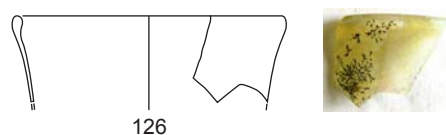

UE.26086

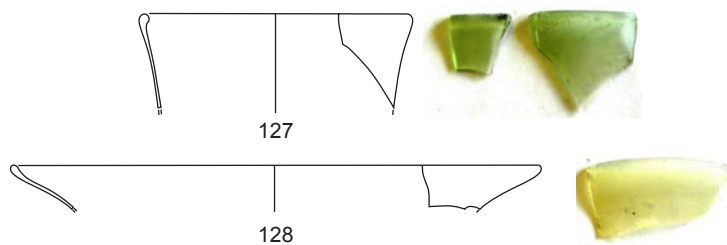

UE.31024

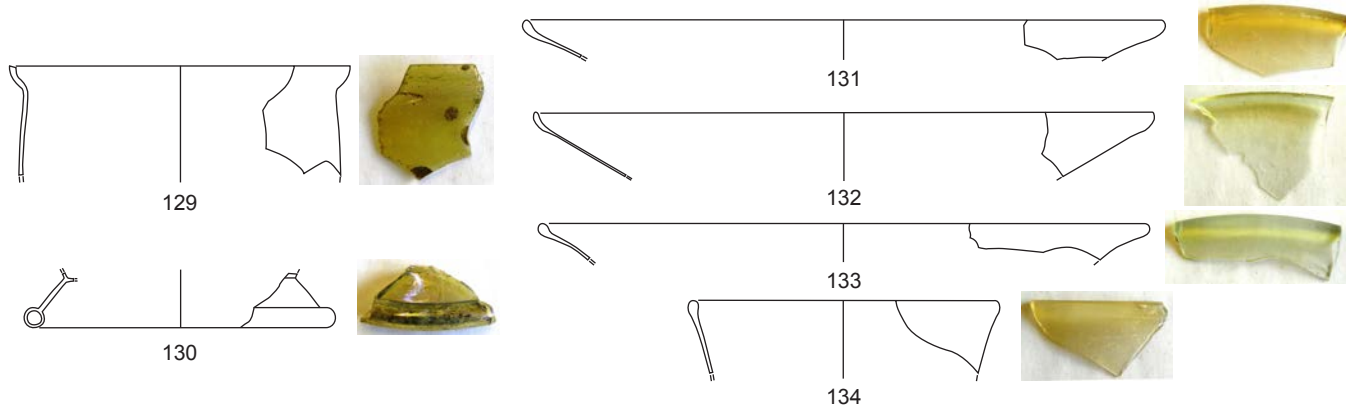

UE.31035

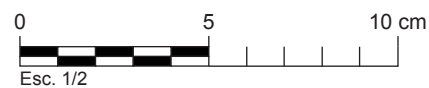
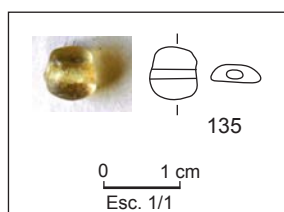

UE.31046

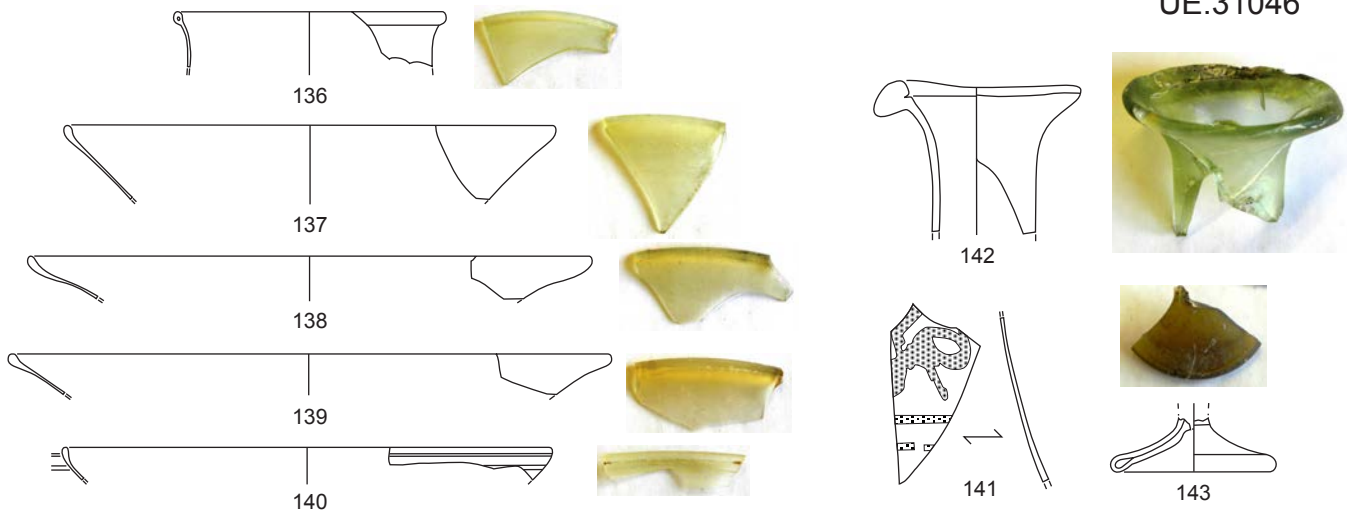

UE.32032

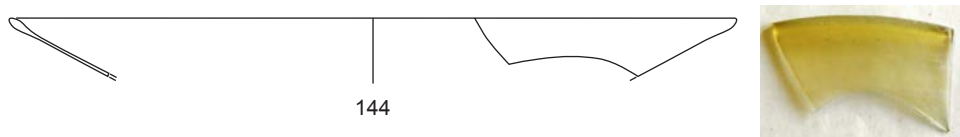

UE.32034

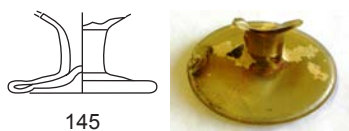

UE.32035



UE.33021

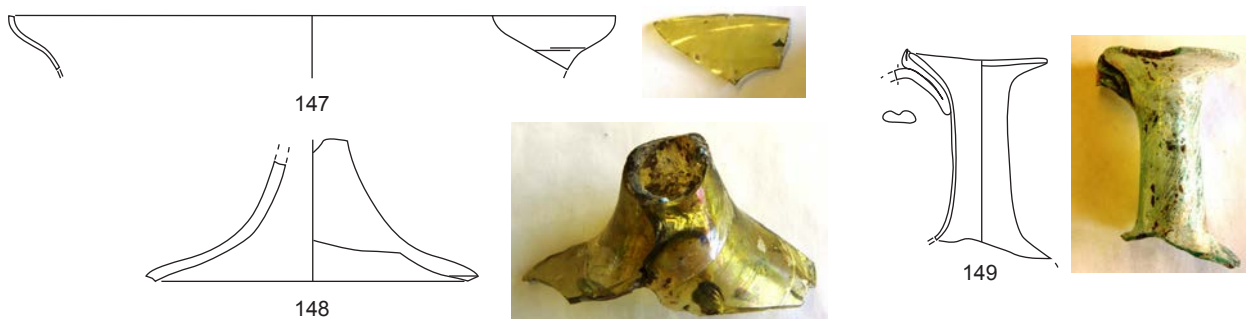

UE.35057



UE.35719

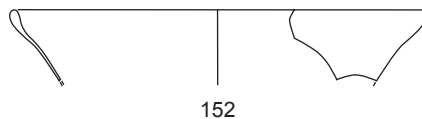

UE.35721

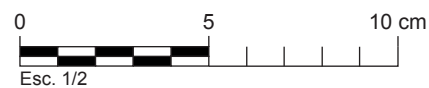

UE.41007

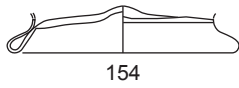

154

UE.41010

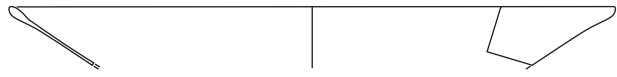

155

UE.41020

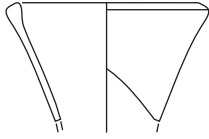

156



157

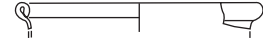

159



158

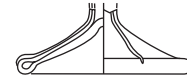

160

UE.41023



161

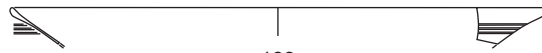

163

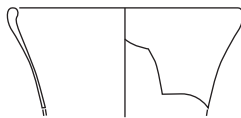

162



164



165

UE.41028

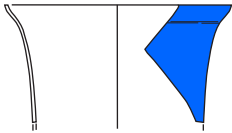

166



169



172

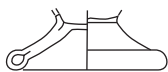

167

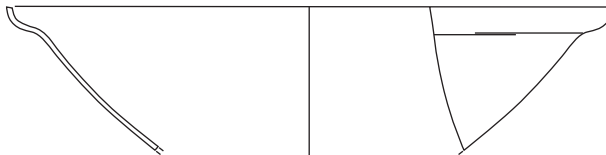

170

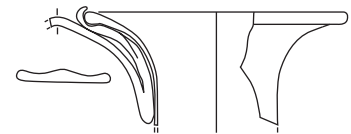

173

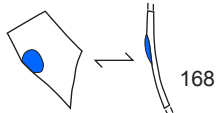

168



171

UE.41030

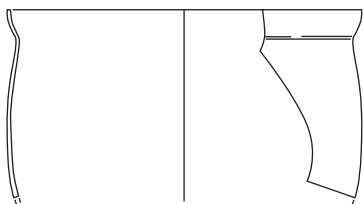

174



177

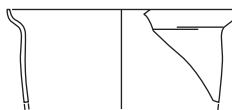

175

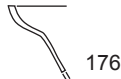

176

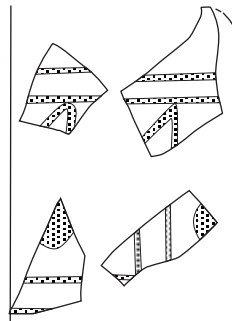

178

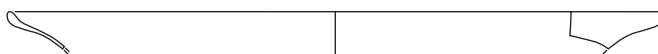

179

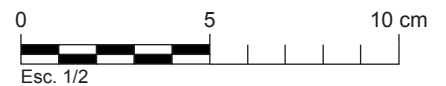



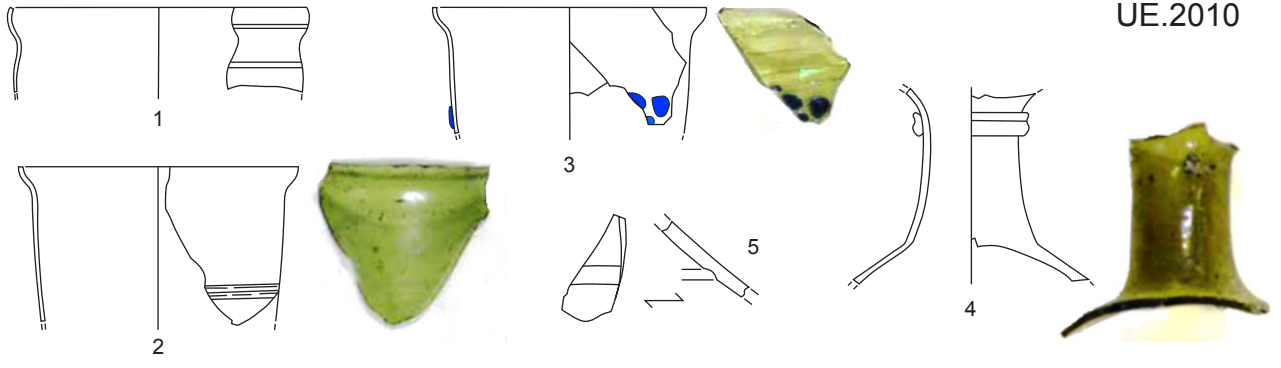

UE.2010

UE.2013

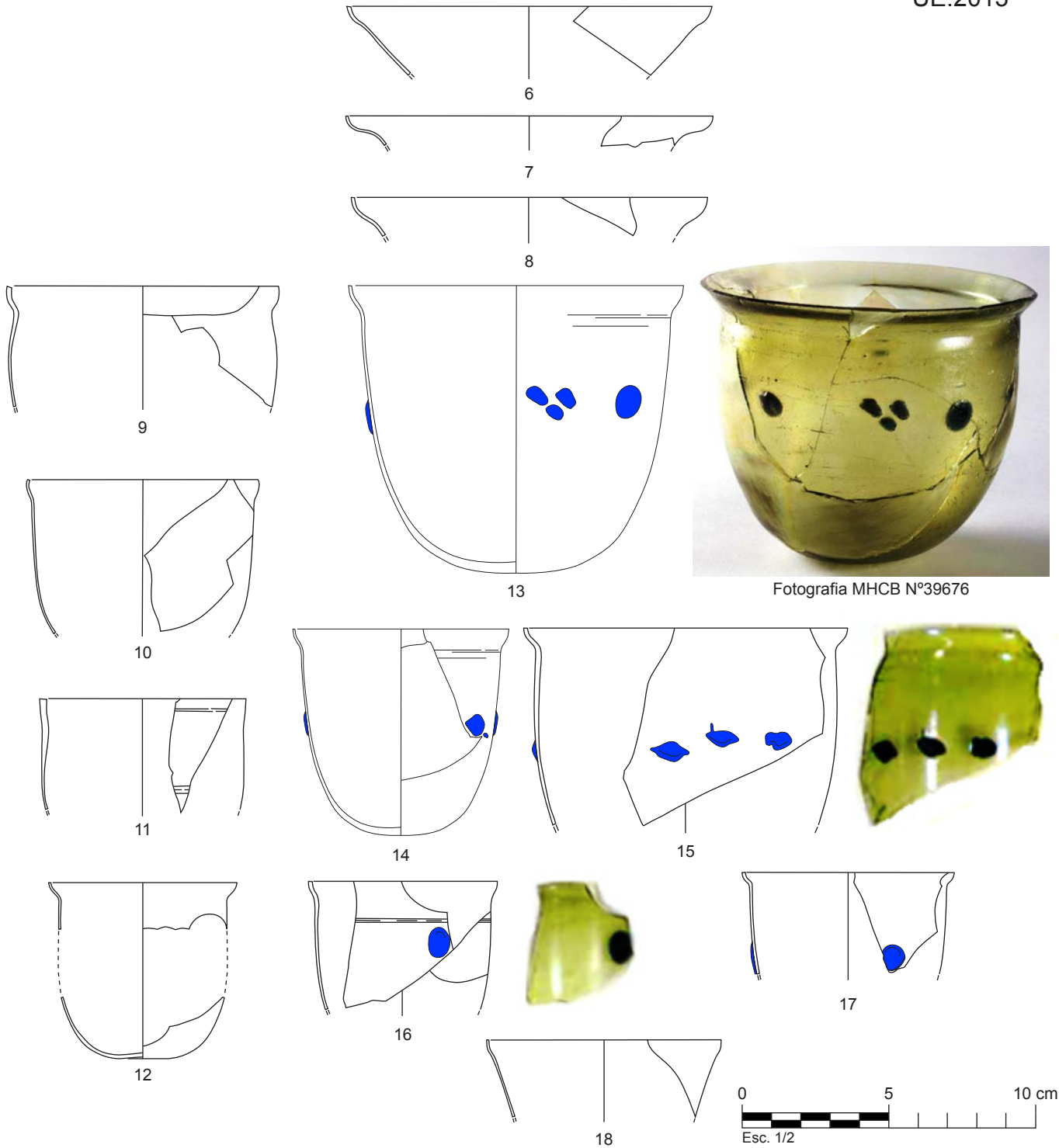

Fotografia MHCB N°39676

UE.2013

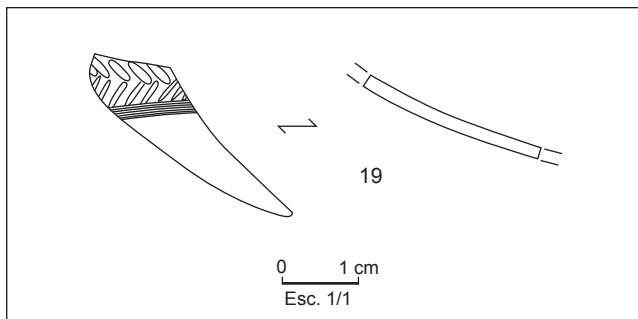

UE.2024

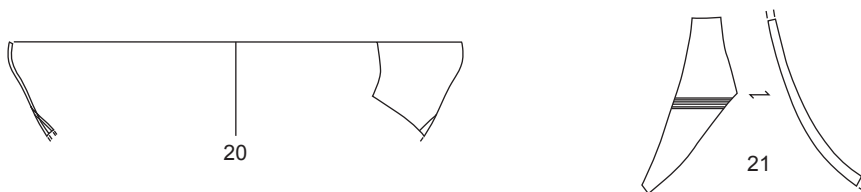

UE.2033

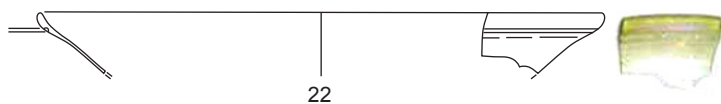

UE.2003

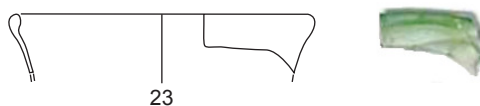

UE.2040

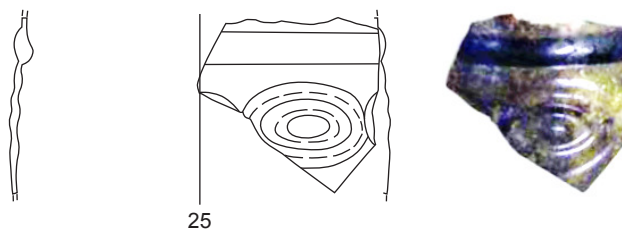

UE.4001

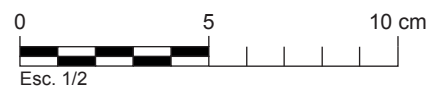

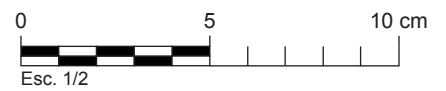
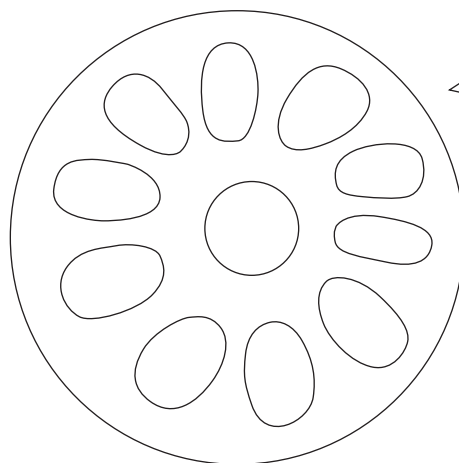
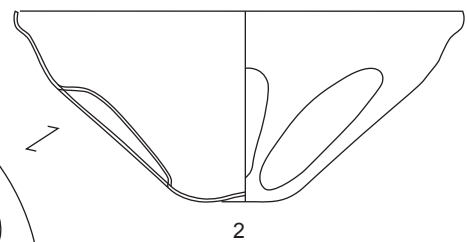

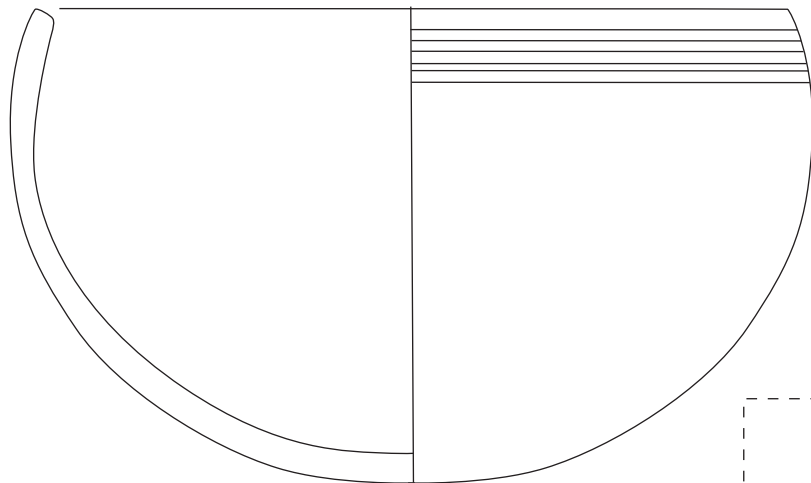

1



Fotografia MHCB N°16451

0 5 cm

Esc. 1/4



0 1 cm  
Esc. 1/1

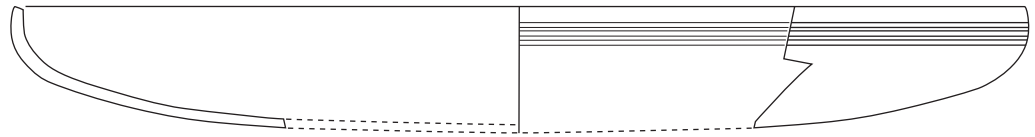

2

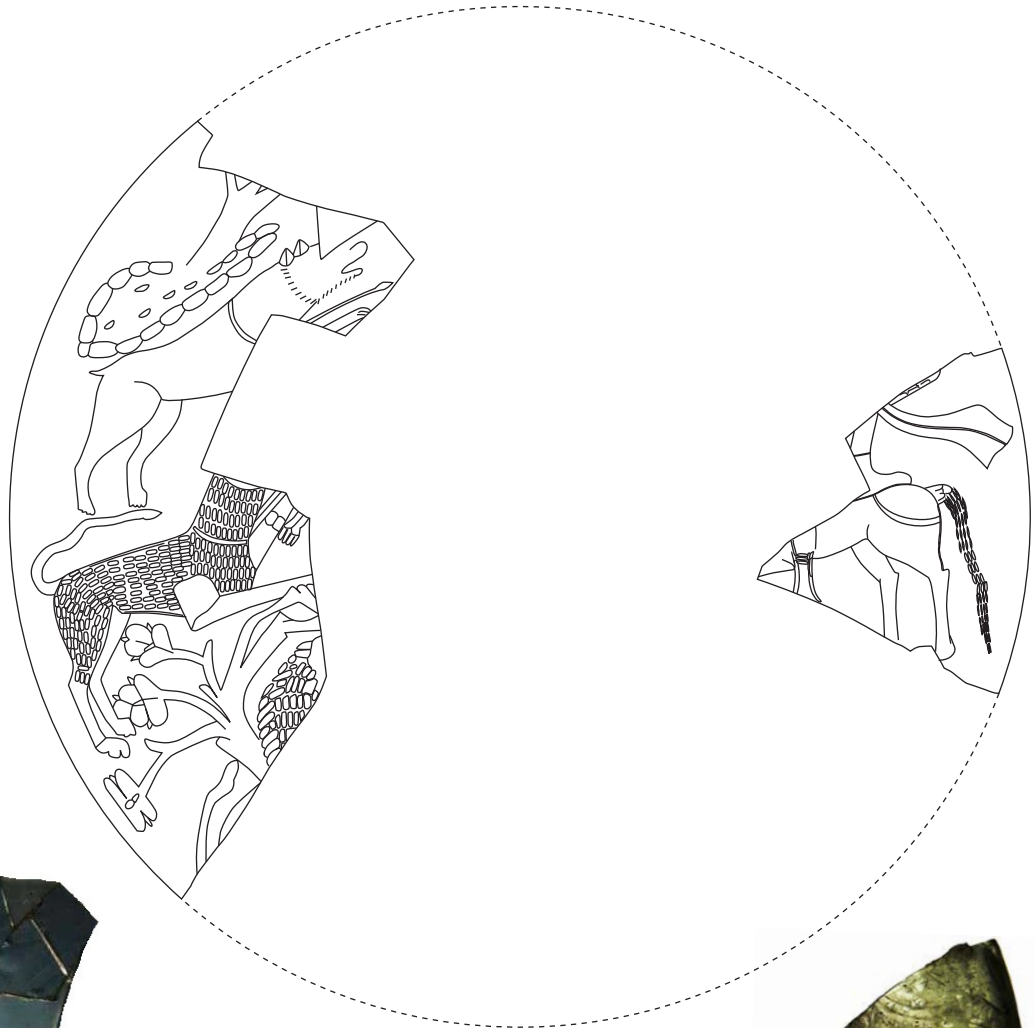

Fotografia MHCN N°16452

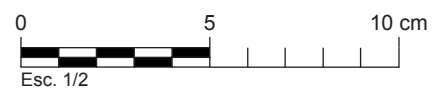
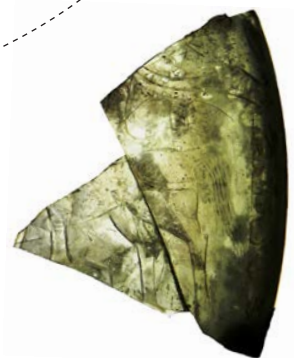

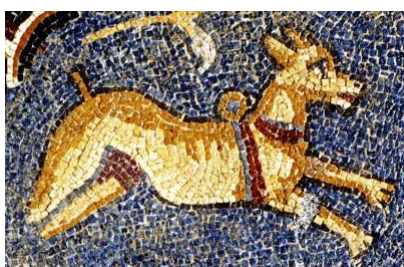
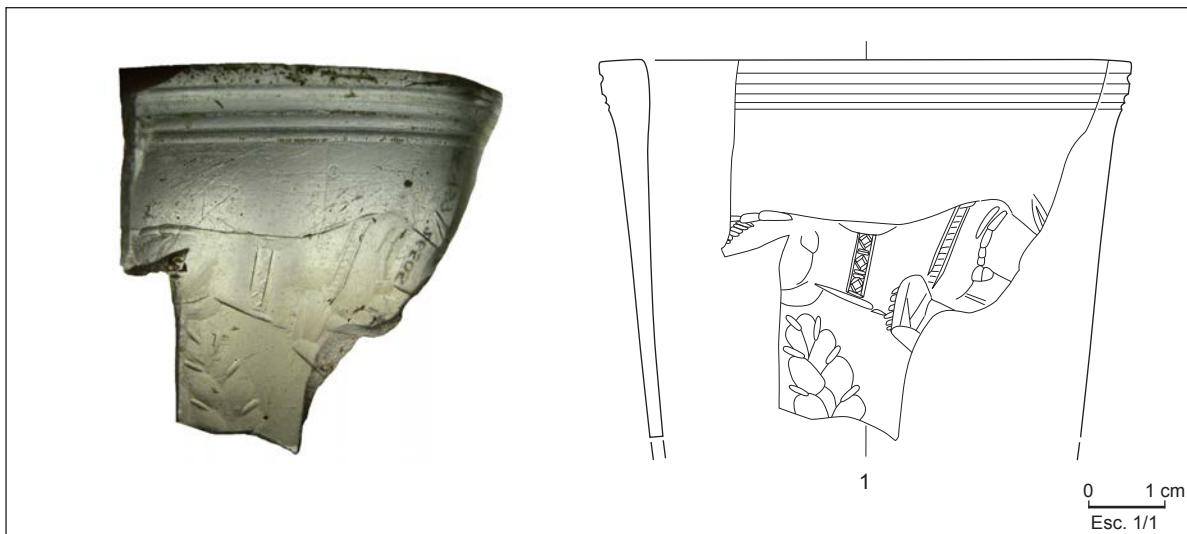

Mosaic de Shechem-Neapolis  
Museu d'Israel  
Extret de Gorzalczany & Rosen 2018

UE.1587

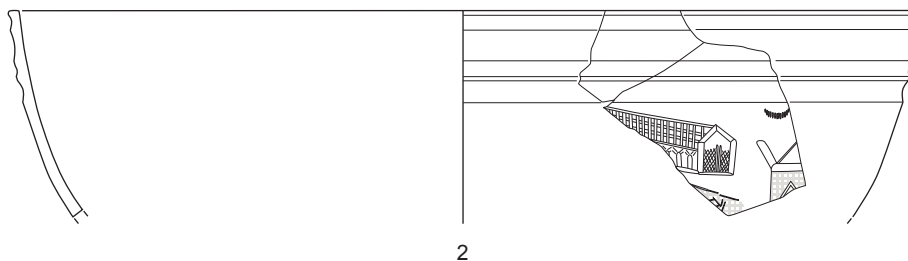

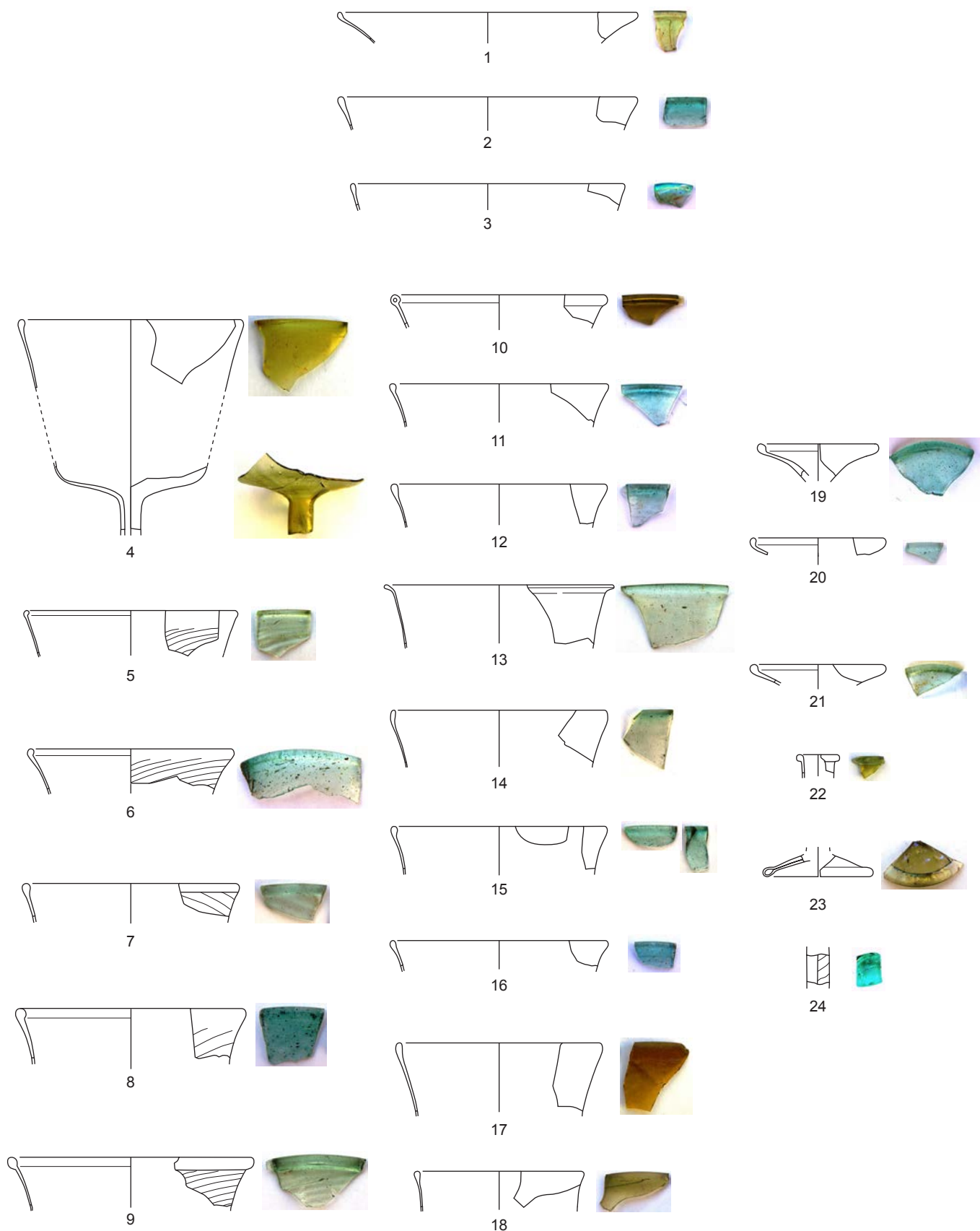

0 5 10 cm  
Esc. 1/2

UE.1017

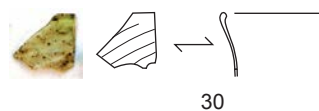
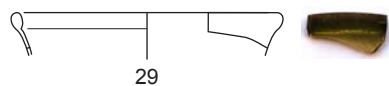

UE.1022

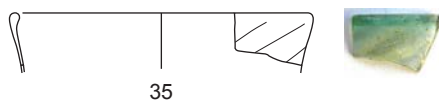
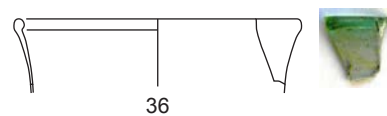
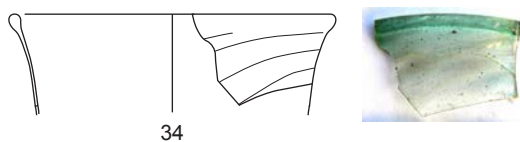

UE.1026

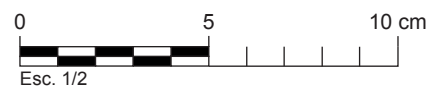
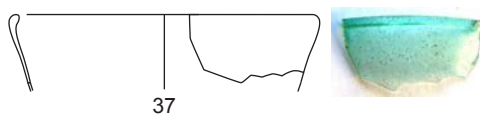



UE.1031

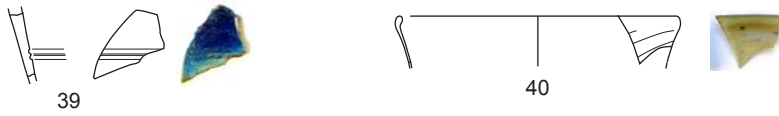

UE.1032

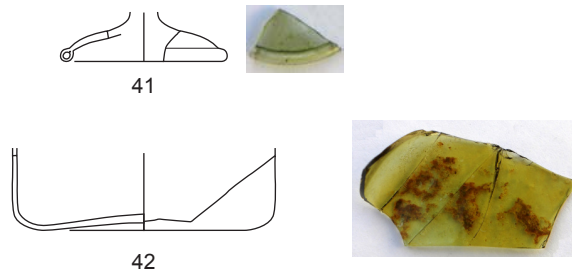

UE.1035



UE.1043

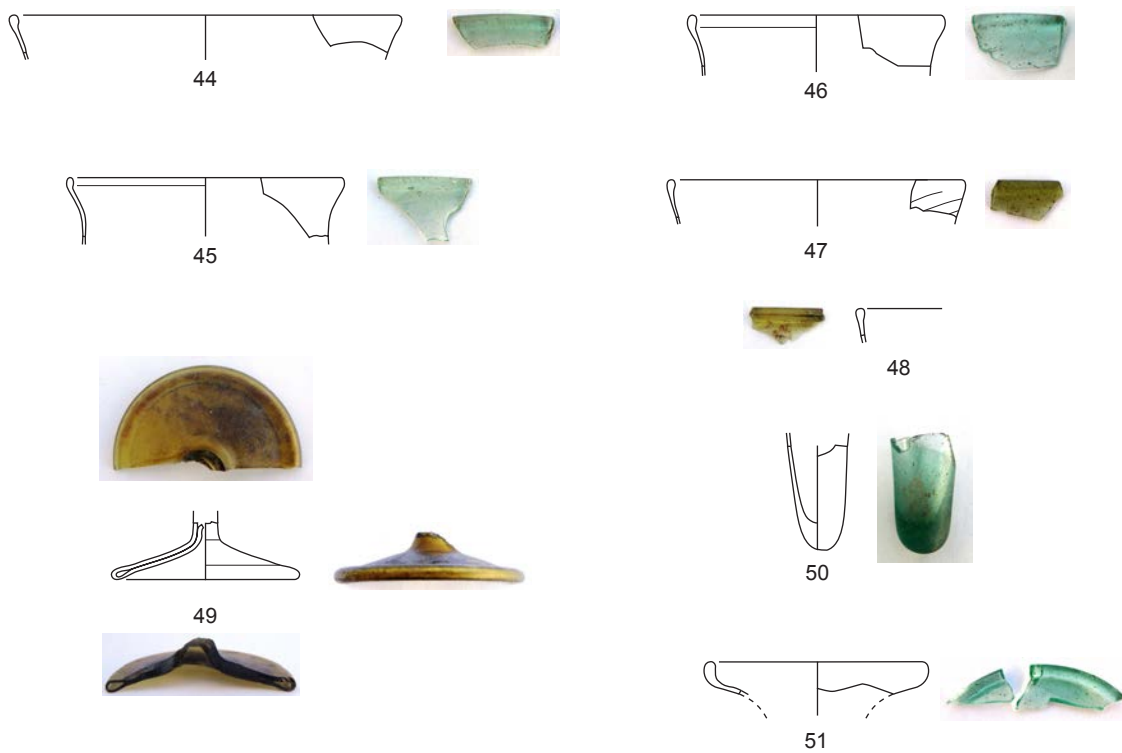

UE.1048

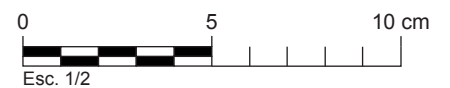
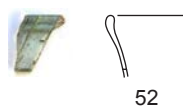

UE.1054

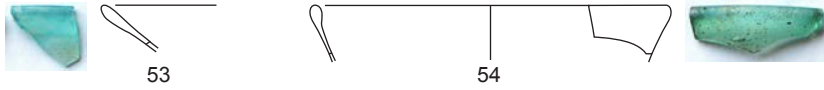

UE.1060

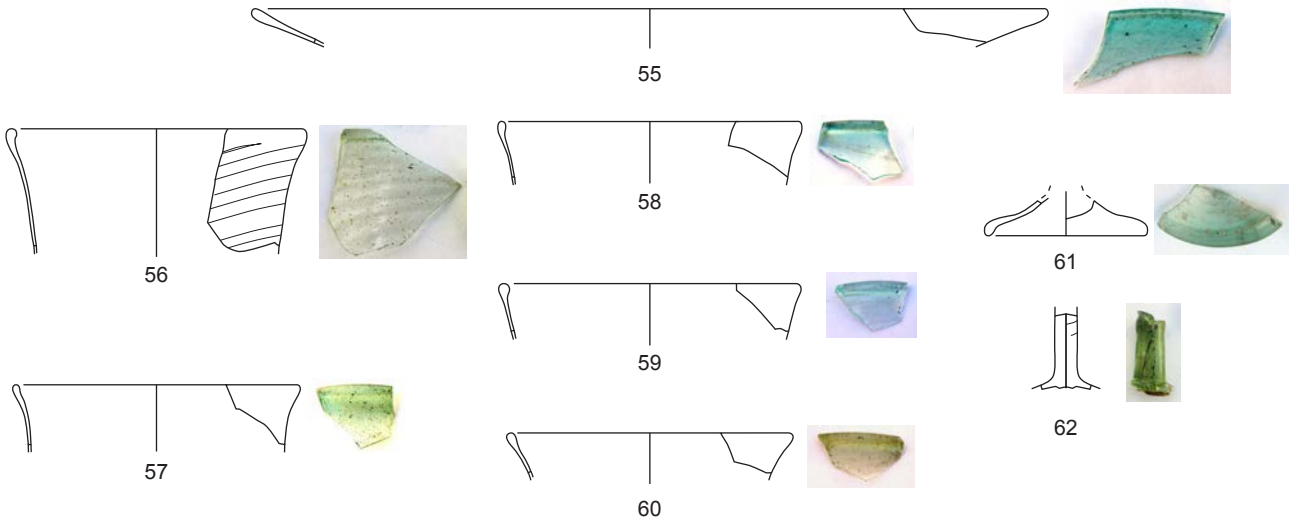

UE.1064

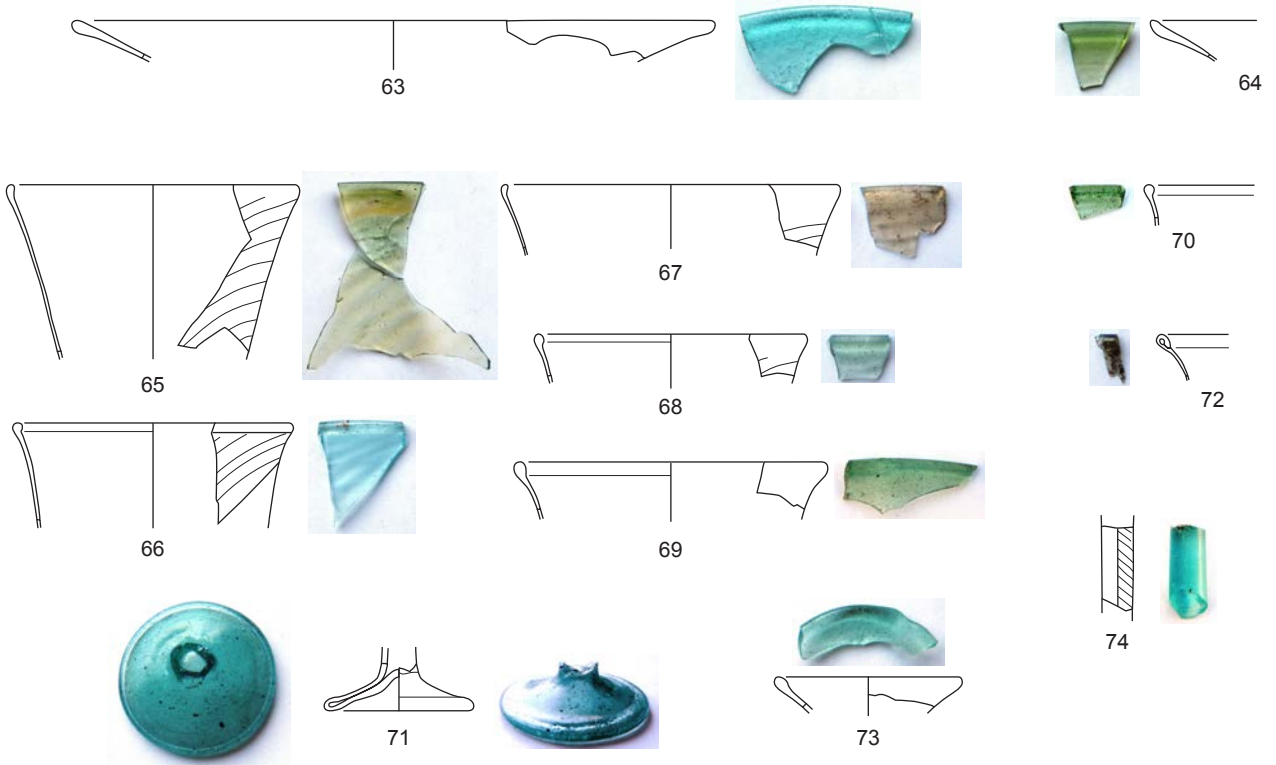

UE.1066

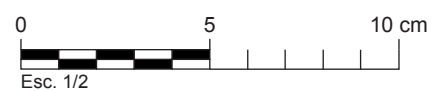
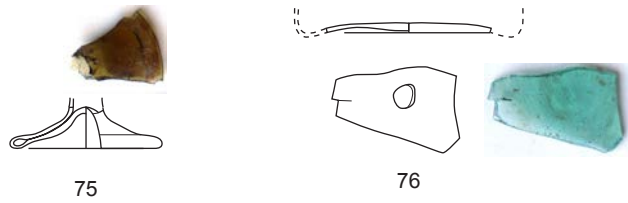

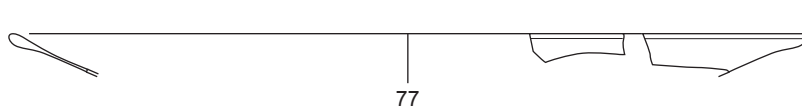

77



78

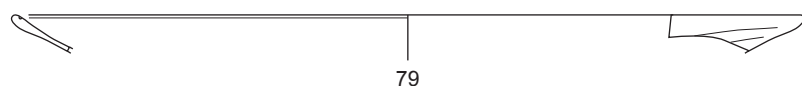

79

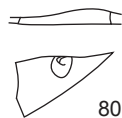

80

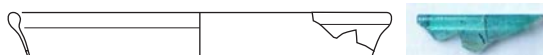

81

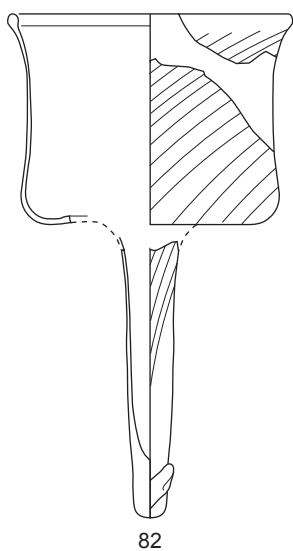

82

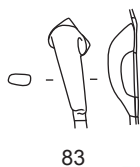

83

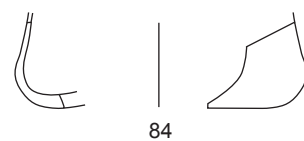

84

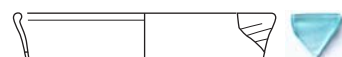
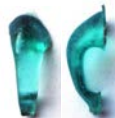

86

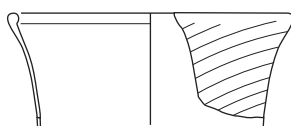

85

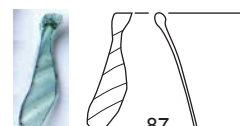

87

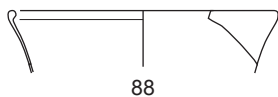

88

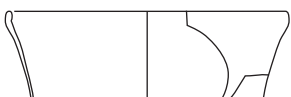

91

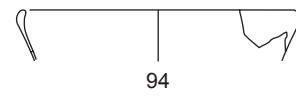

94

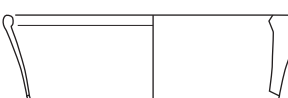

89

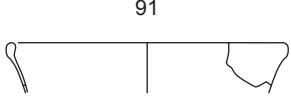

92

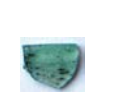

95

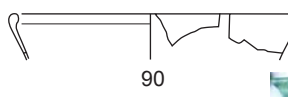

90

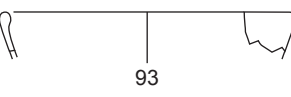

93



96

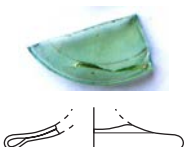

97



98



99

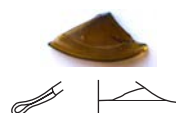

100

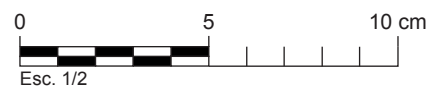

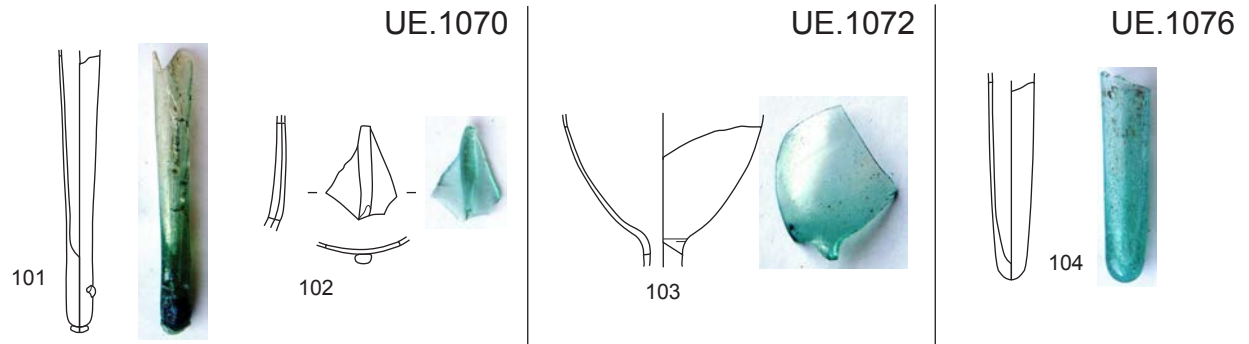

UE.1079

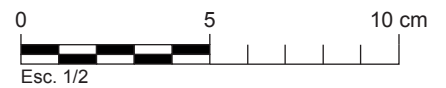
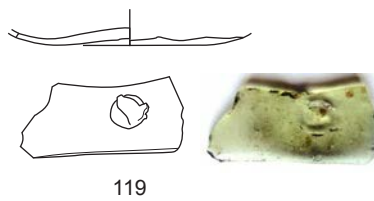
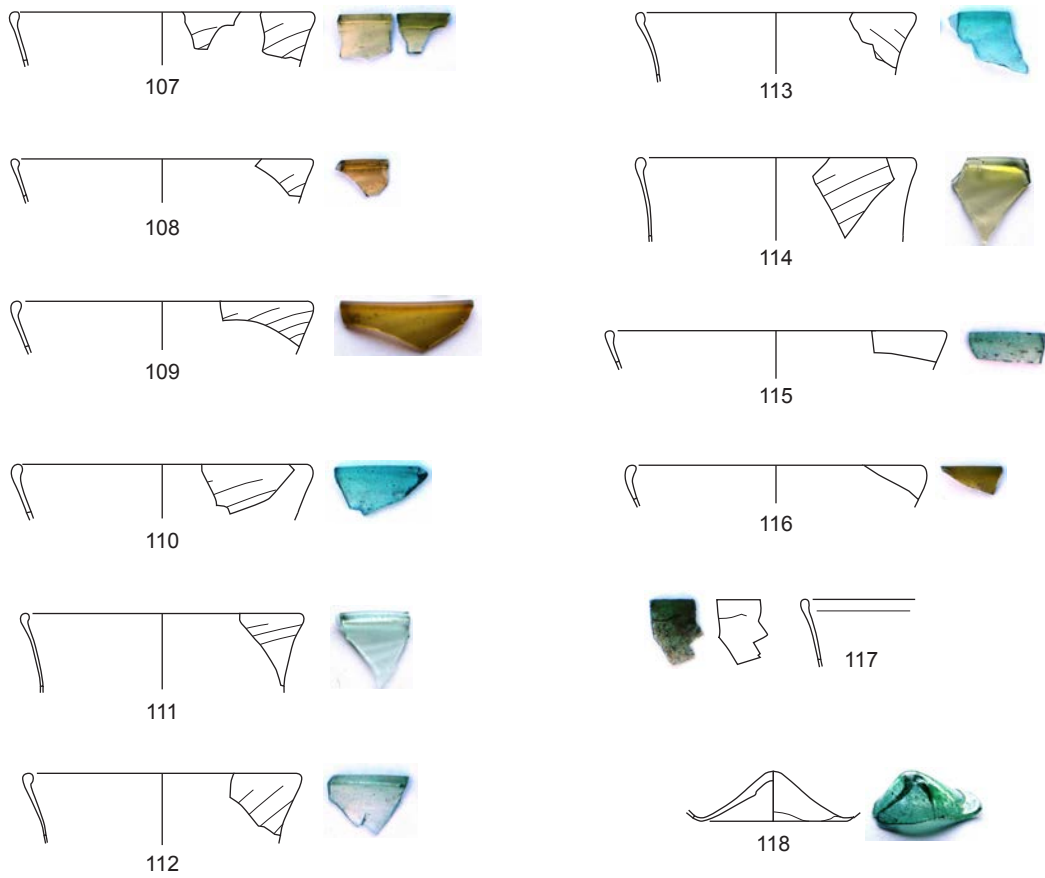
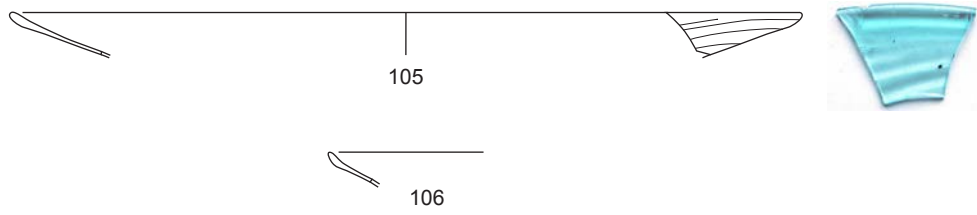

UE.1080

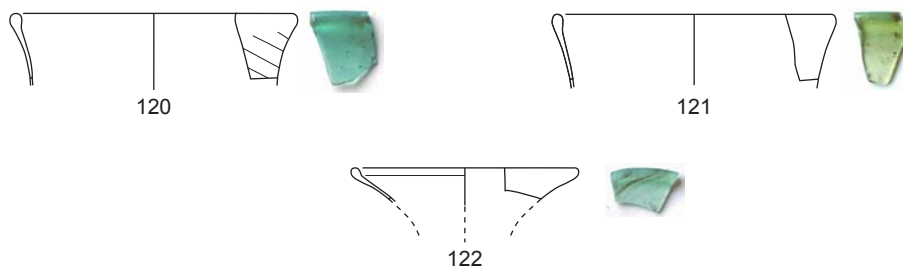

UE.1084

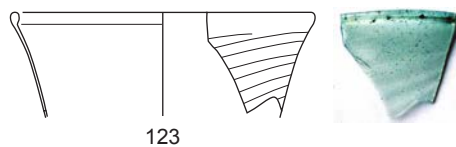

UE.1011

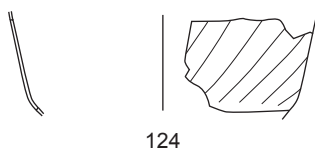

UE.1020

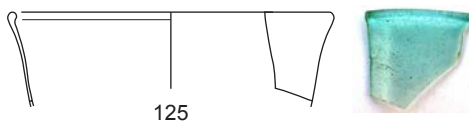

UE.1040

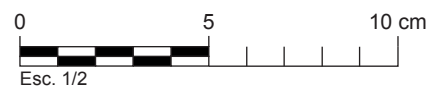
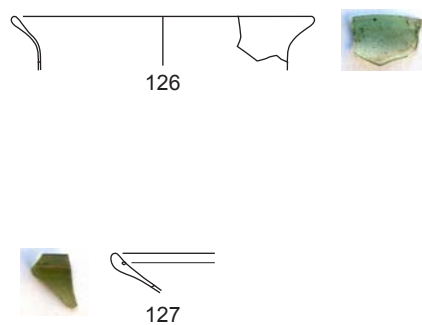

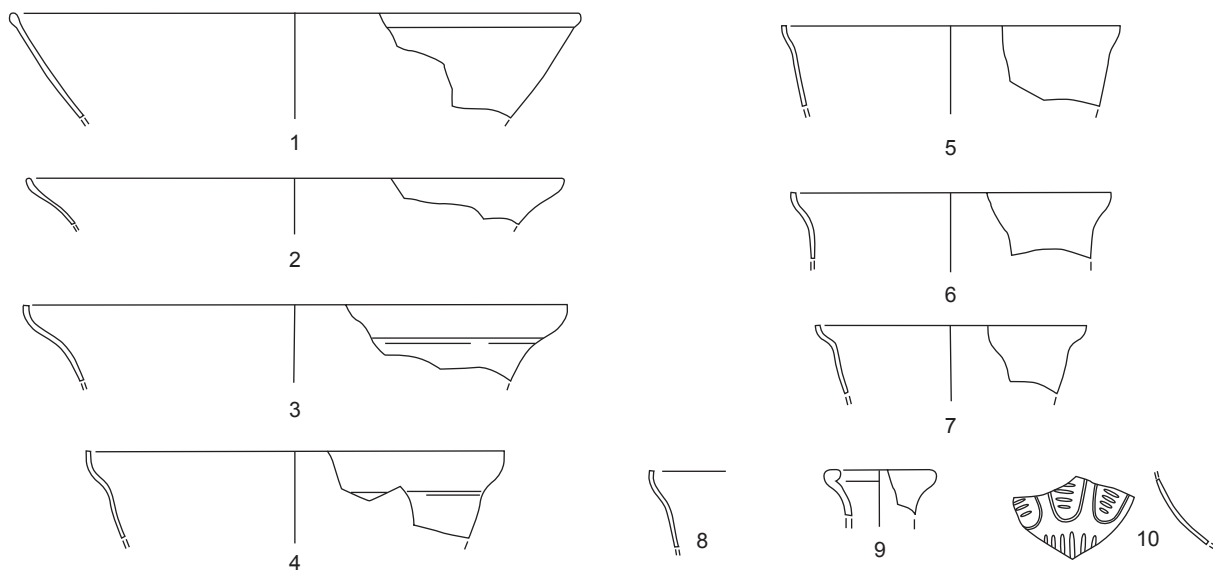

Ca l'Estrada (Canovelles) 2004-2005

FS-117. Ue-1418

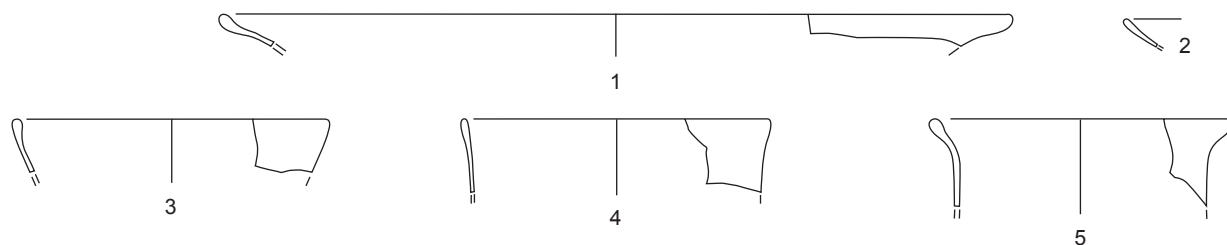

Pla del Serrador (Les Franqueses) 2004

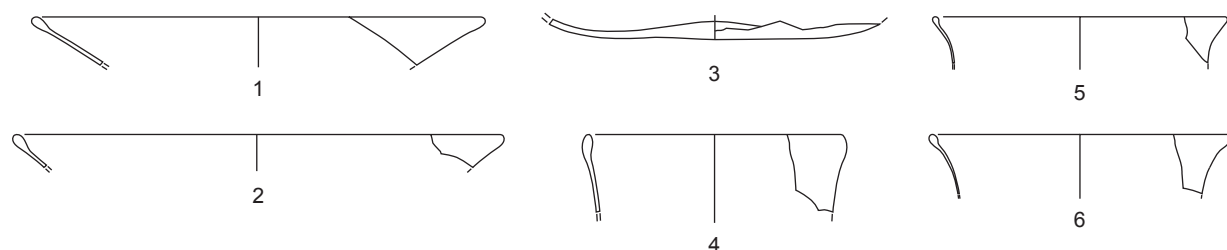

C/ Gaietà Ventalló (Mollet) 2010-2012

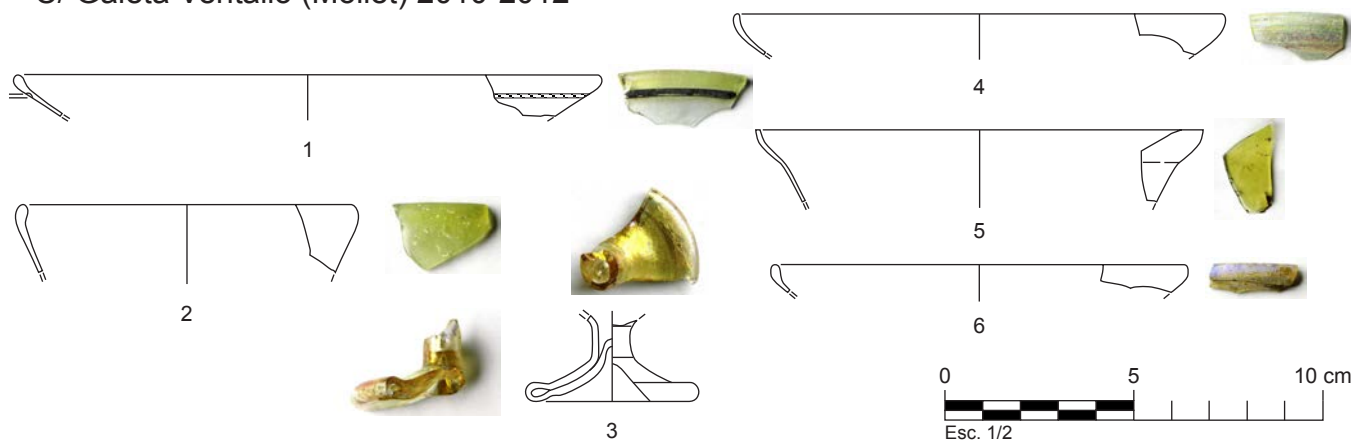

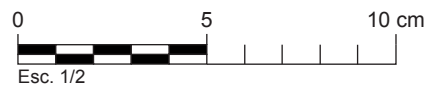
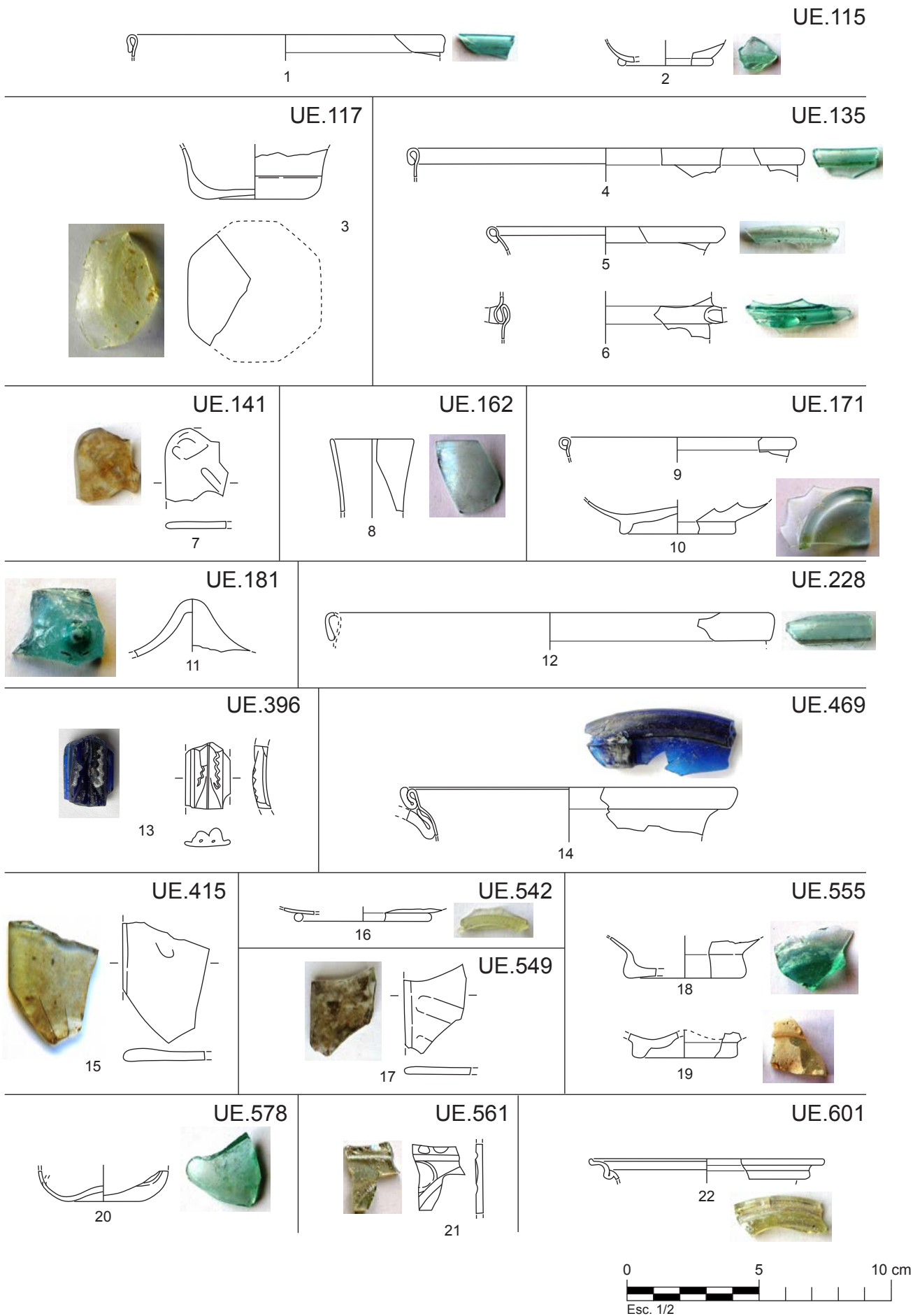

UE.665

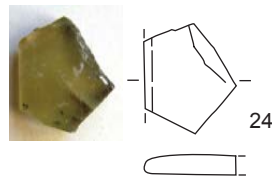
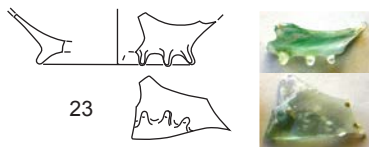

UE.750

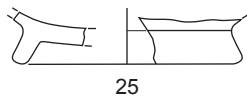

25



UE.798



26



UE.854

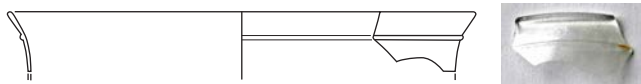

27

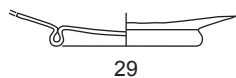

29

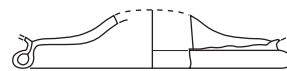

30



28



UE.872

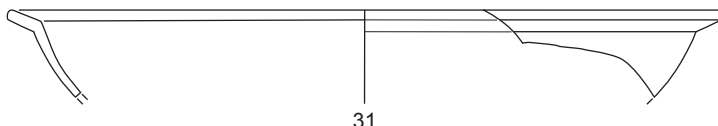

31



32

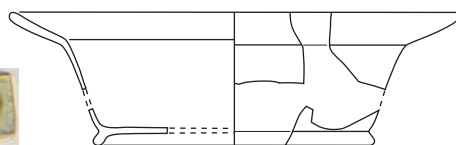

33

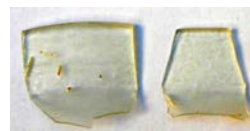
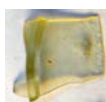

UE.883

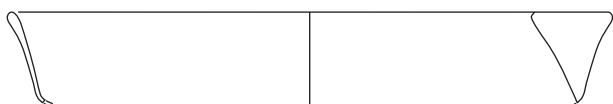

34

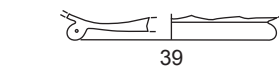

39



40

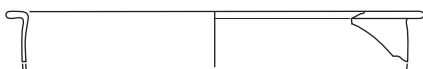

35

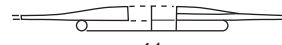

41



36



42

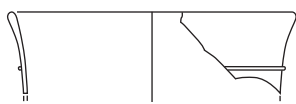

37

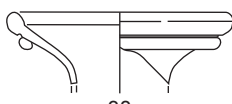

38

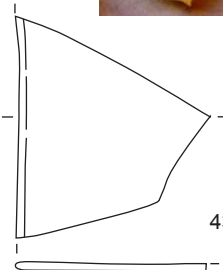
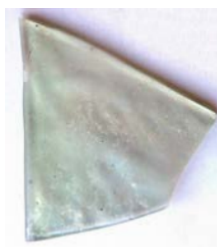

43

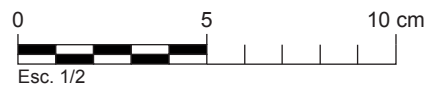



UE.886

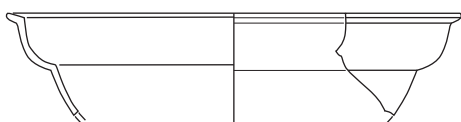

44

UE.888

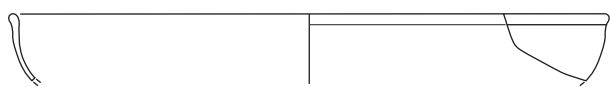

45



49

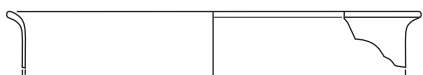

46

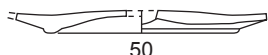

50

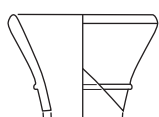
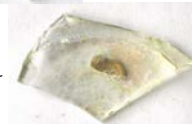

47

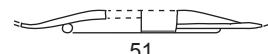

51

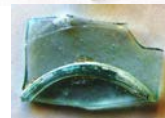

48



52

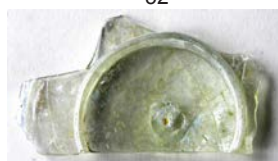

53



UE.910



54



UE.927

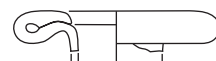

55

UE.942

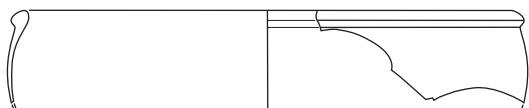

56

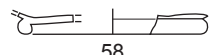

58

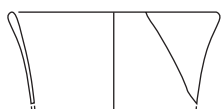

57



60

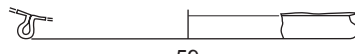

59

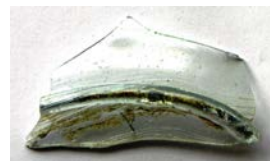

UE.944



61



UE.962



62



63



64



65

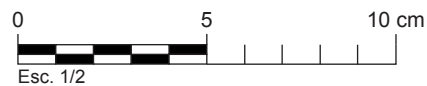

Esc. 1/2

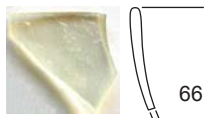

66

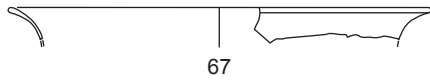

67

UE.980



UE.993

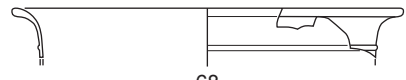

68

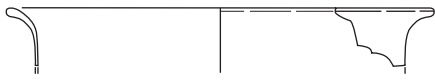

69

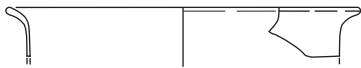

70



71



72

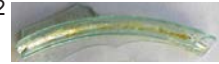

73



UE.994

UE.1000

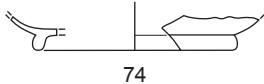

74

UE.1002

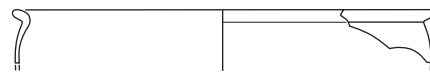

75



76

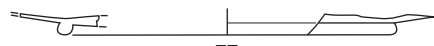

77



UE.1009

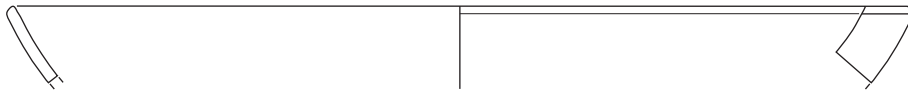

78

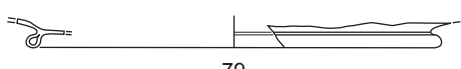
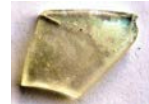

79



UE.1010

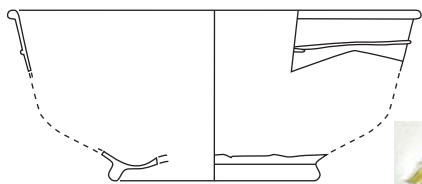

80



UE.1024



81



UE.1020

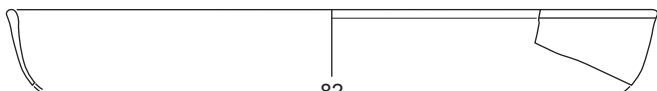

82



83



84



85

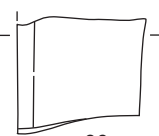

86

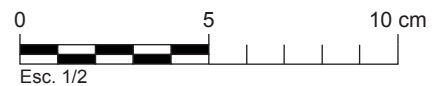

UE.1115

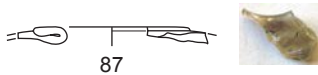

87

UE.1229

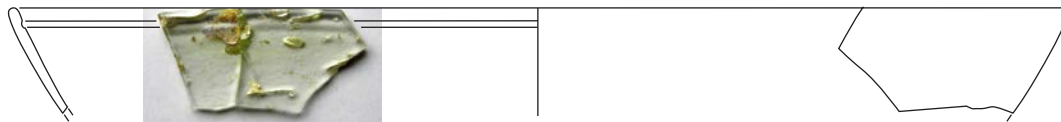

88

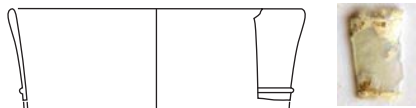

89

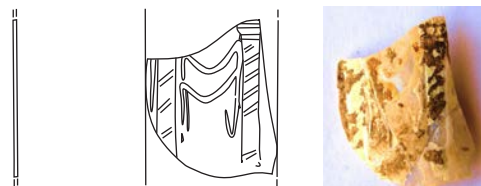

90

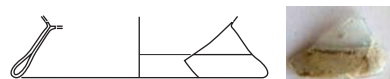

91

UE.1400

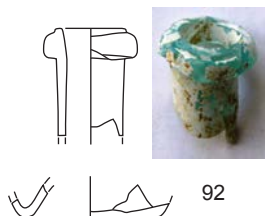

92

UE.1403

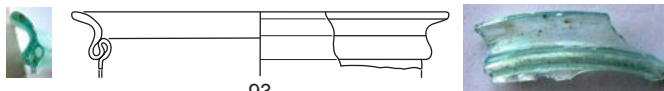

93

UE.1476

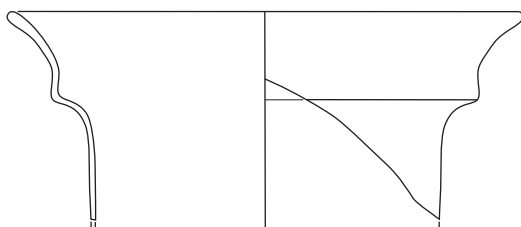

94

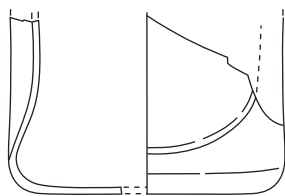

95



96

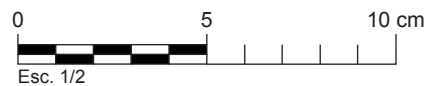

UE.1476



UE.1488

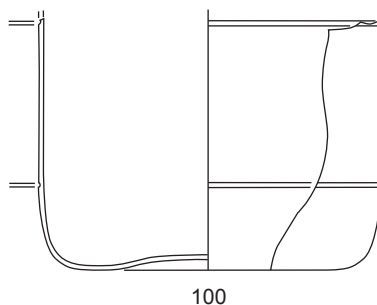
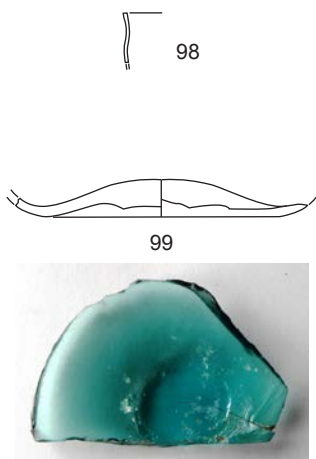

UE.1525

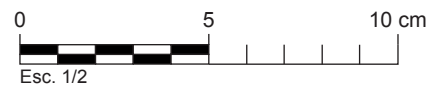
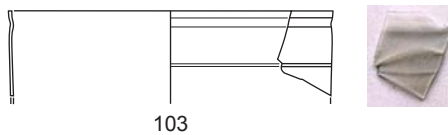
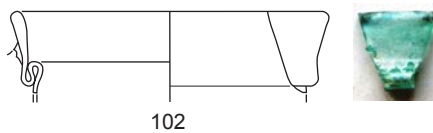
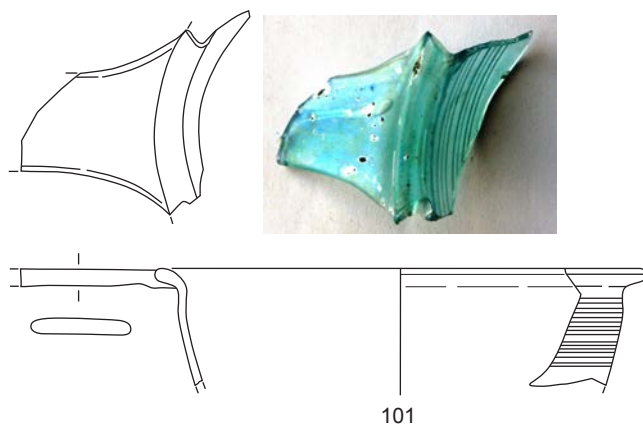

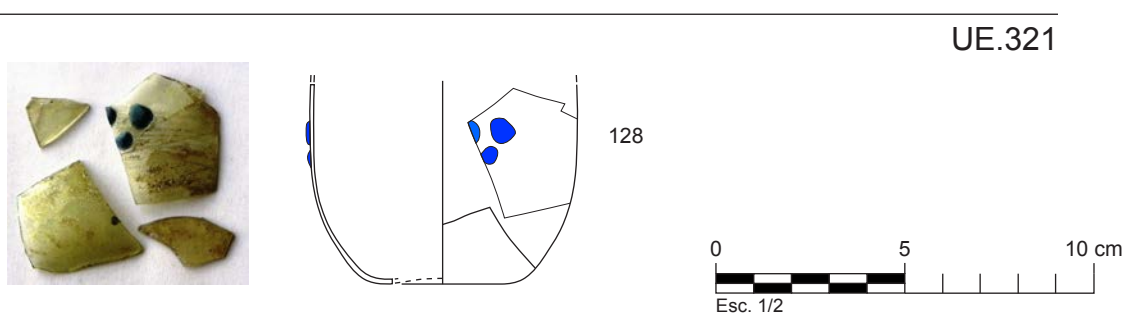
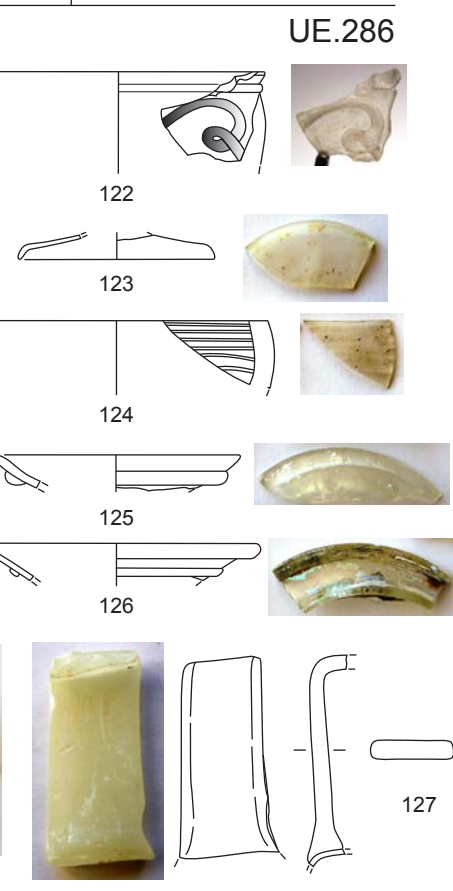
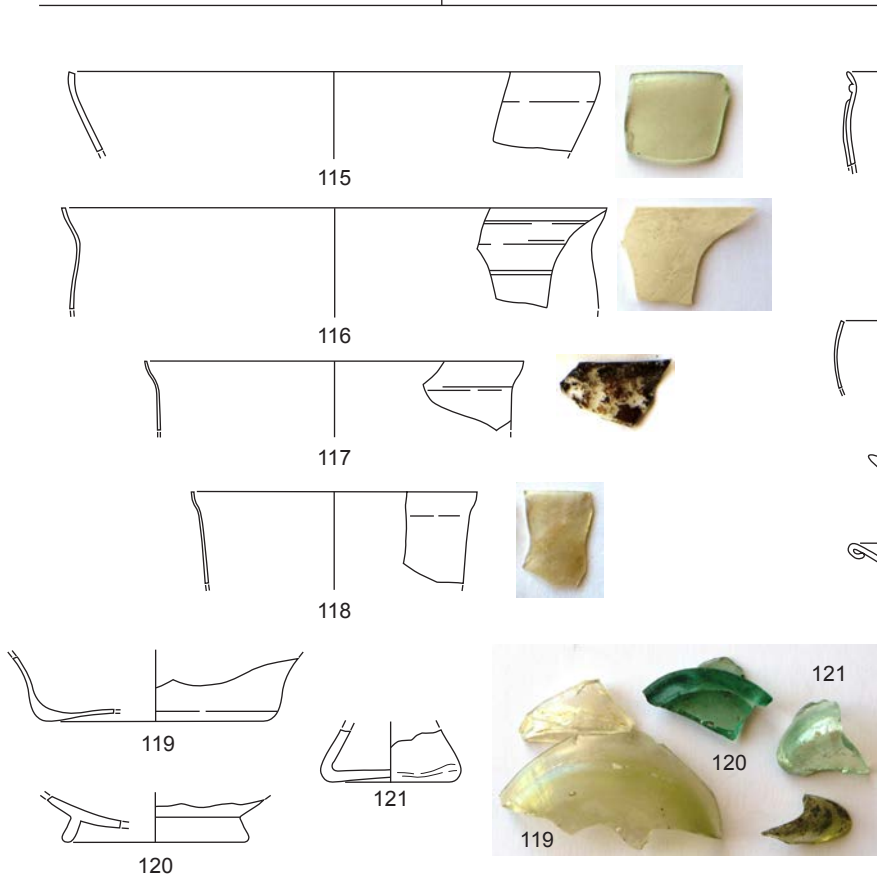
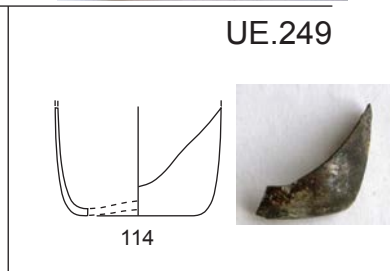
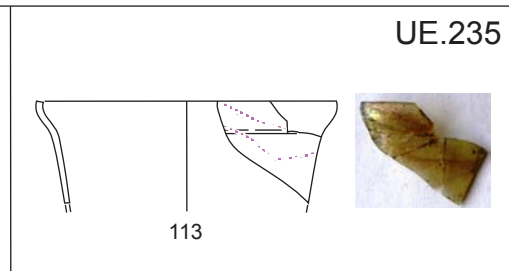
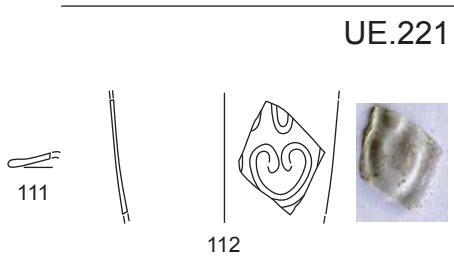
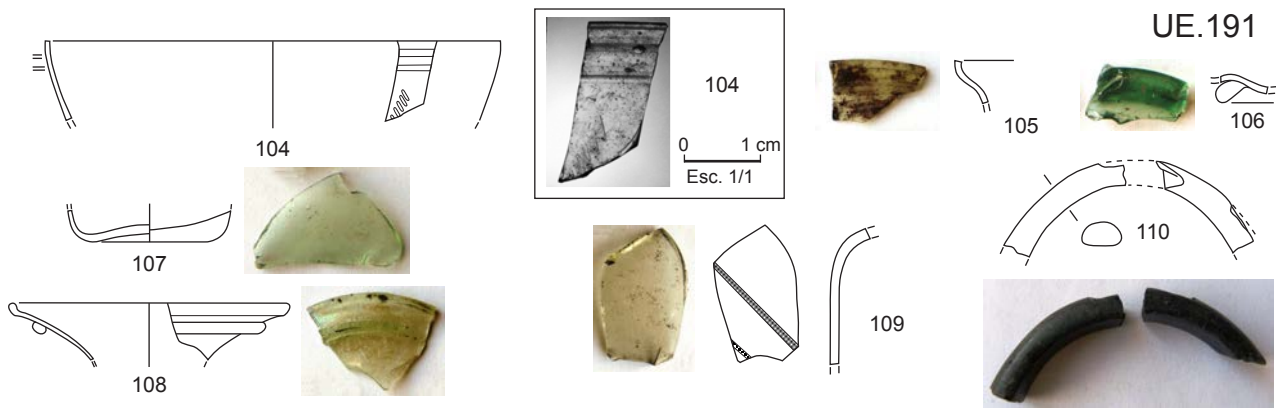

UE.372

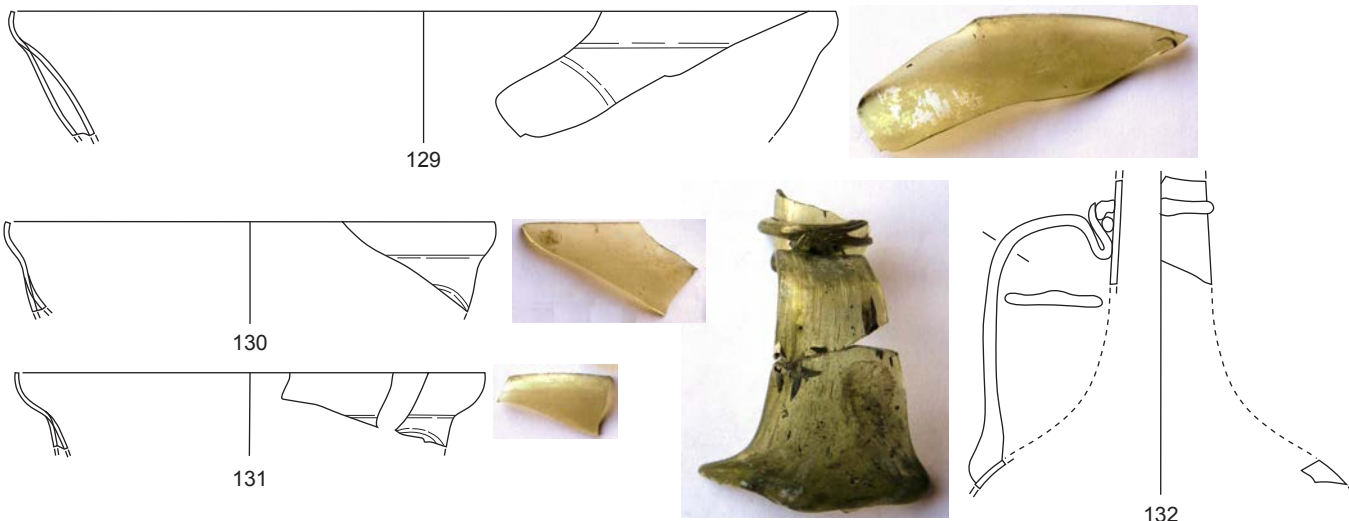

UE.374

UE.380

UE.386

UE.504

UE.511

UE.536

UE.537

UE.544

UE.560

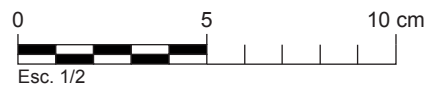

UE.582

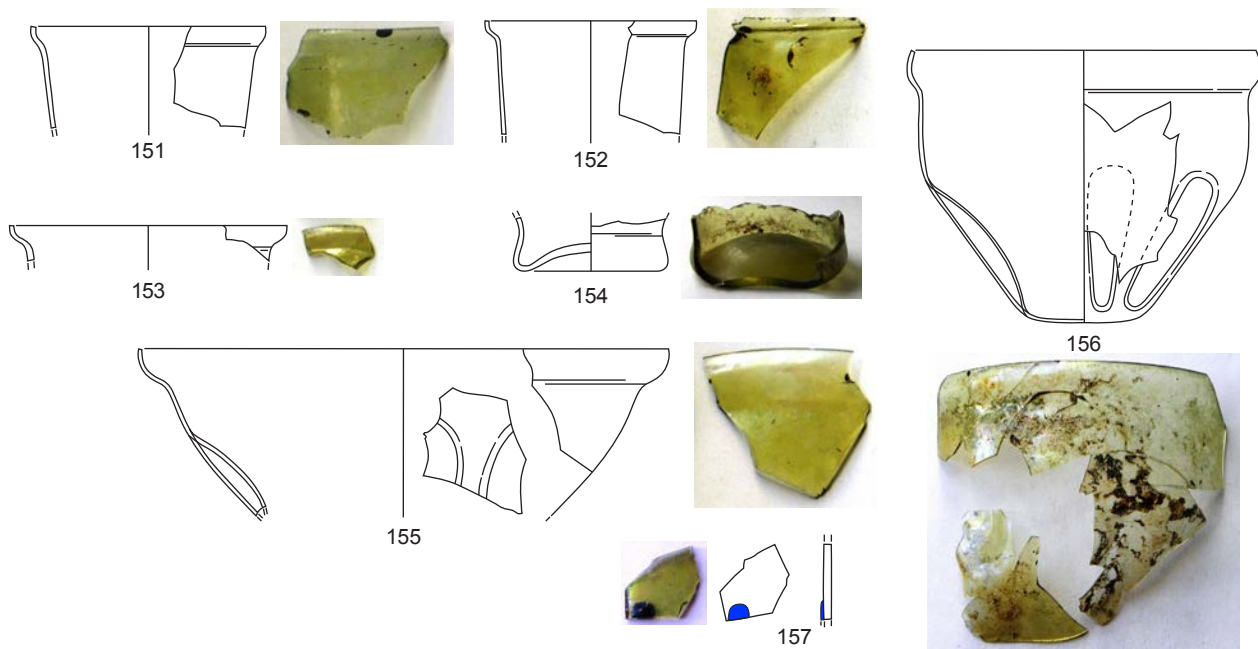

UE.590

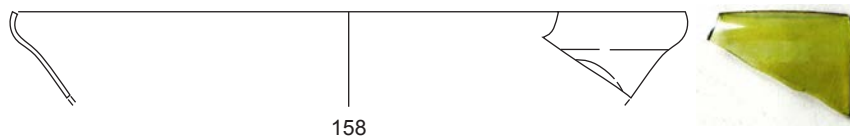

UE.591

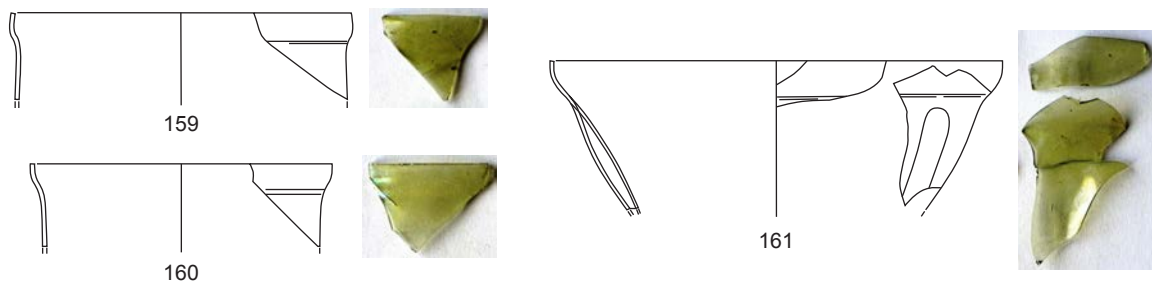

UE.616

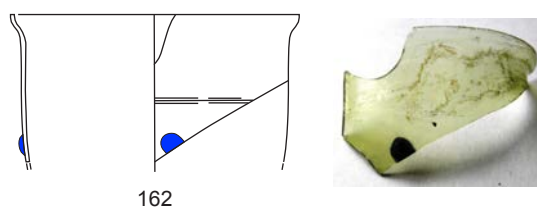

UE.633

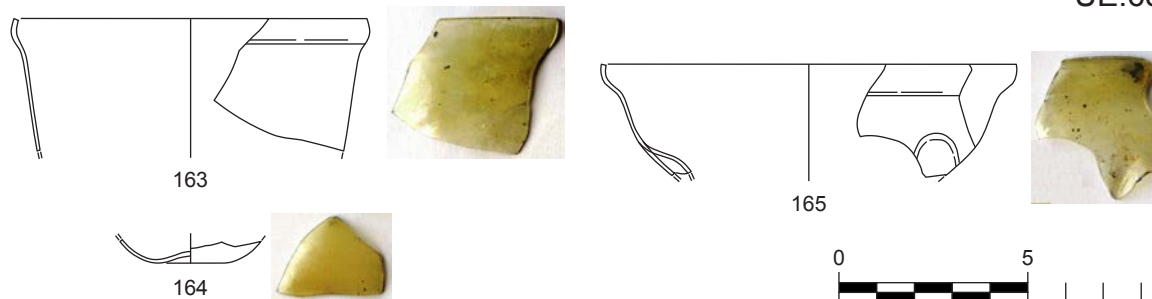

UE.640

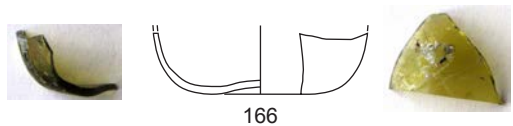

166



167

UE.655

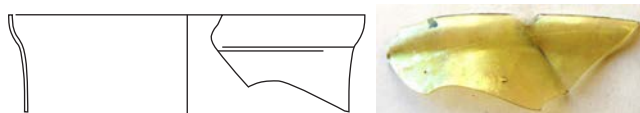

168



169

UE.694



170

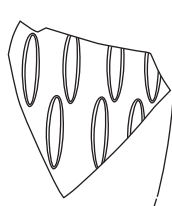

UE.713

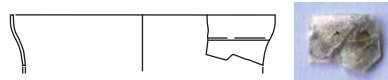

171

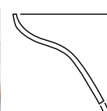
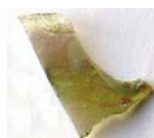

172

UE.726



173



UE.758



174

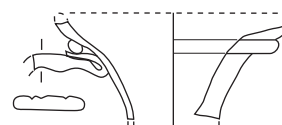

177

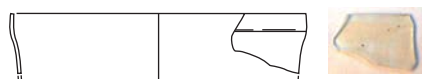

175



178

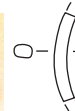

179

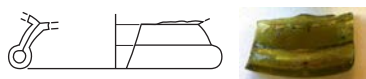

176

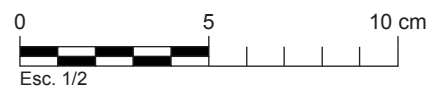



UE.848

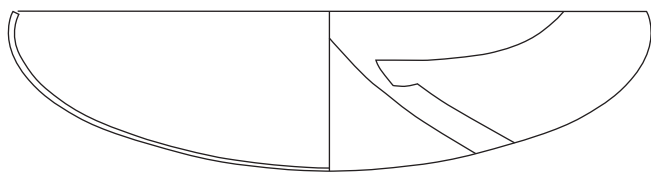

180

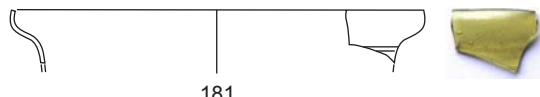

181

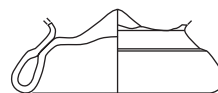

182



Ues.869 i 876



183

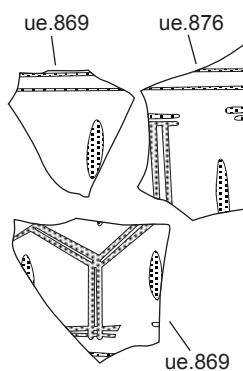

UE.884

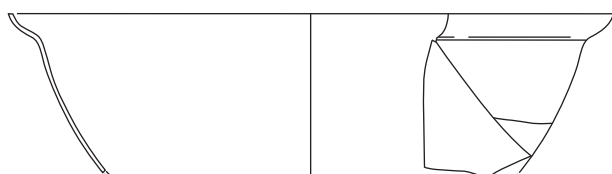

184



185

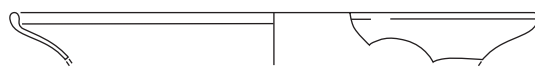

186

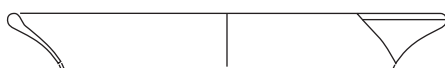

187



188



189



190



191



192



193

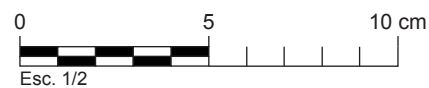

UE.923

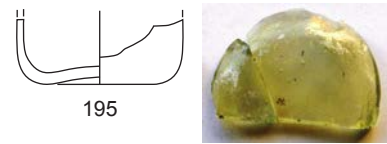
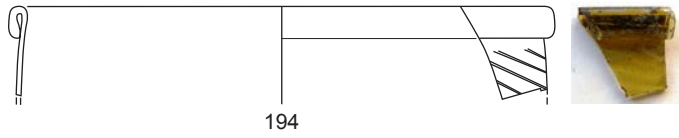

UE.935

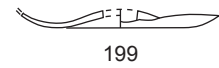
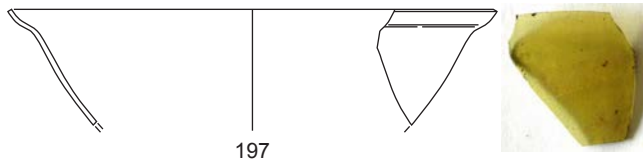
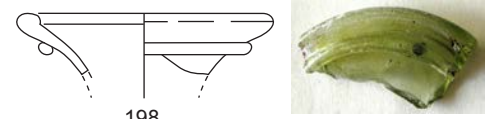
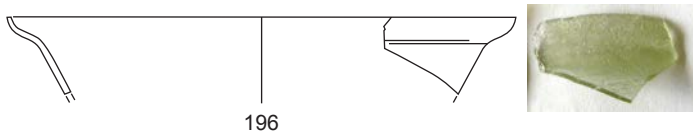

UE.1013

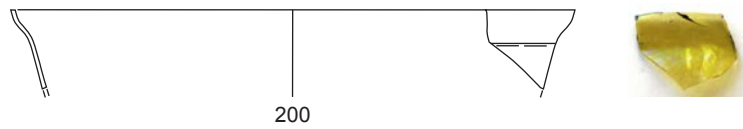

UE.1016

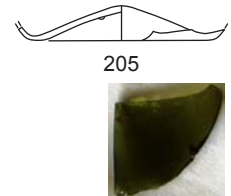
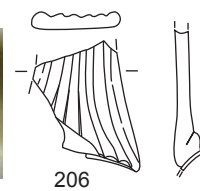
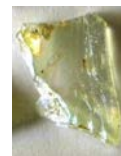
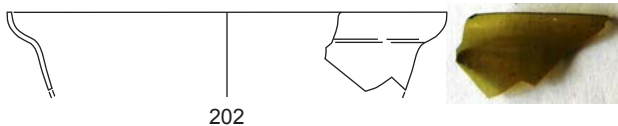
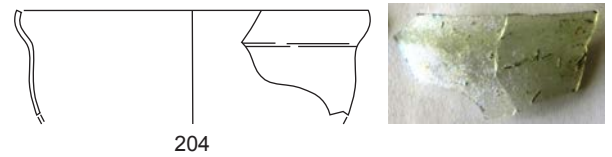
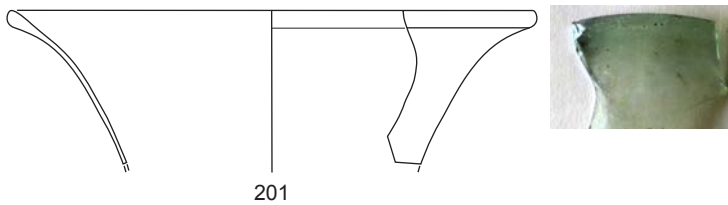

UE.1025

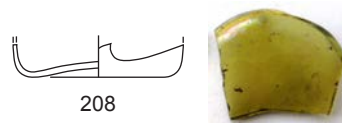
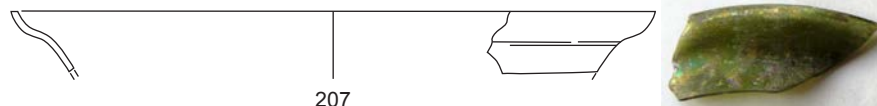

UE.1039

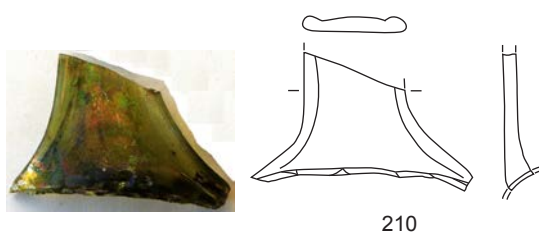
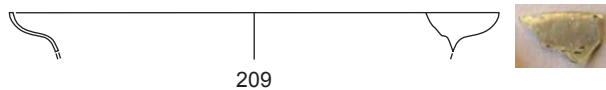

UE.1040

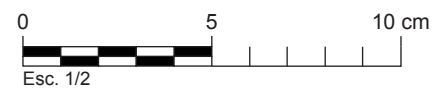
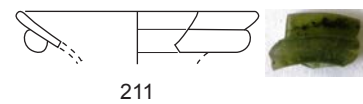

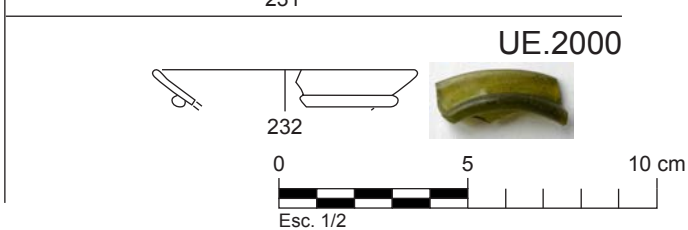
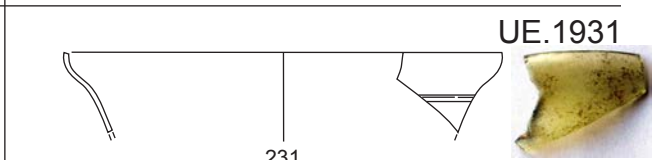
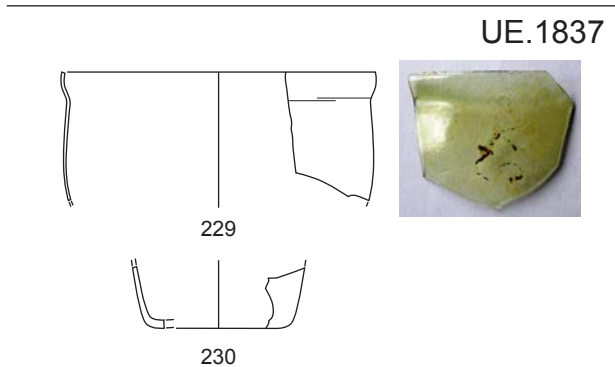
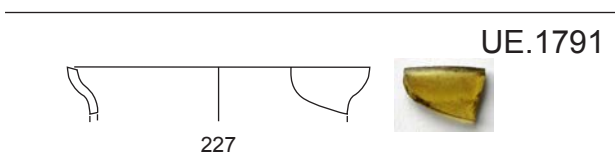
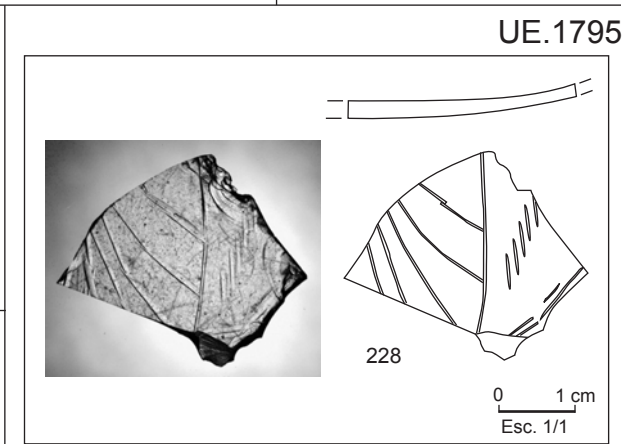
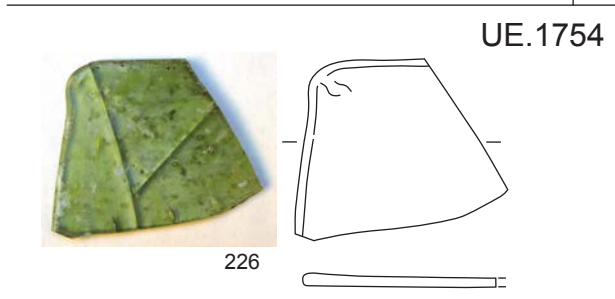
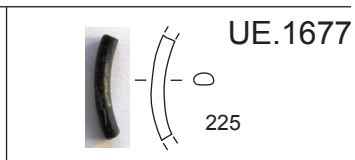
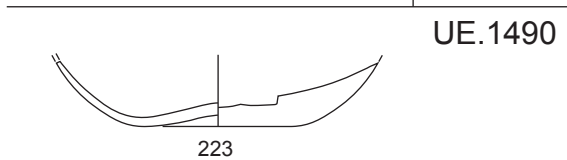
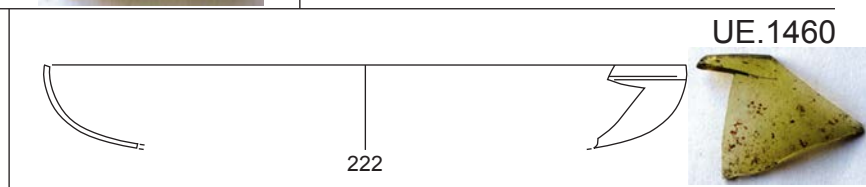
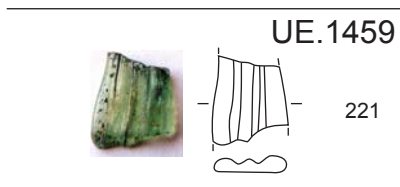
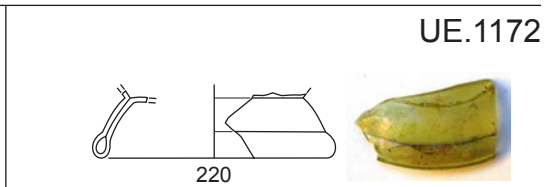
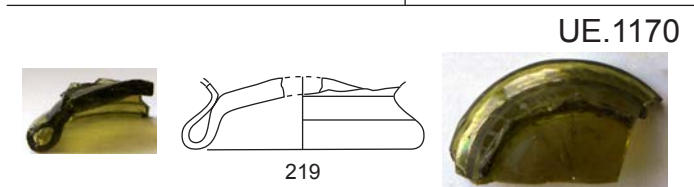
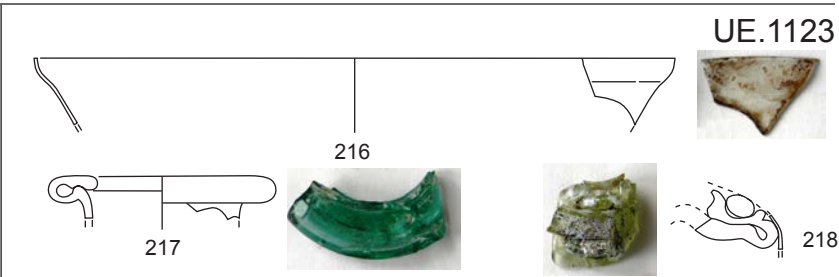
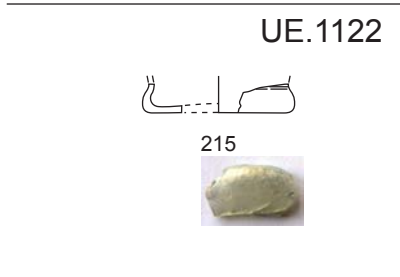
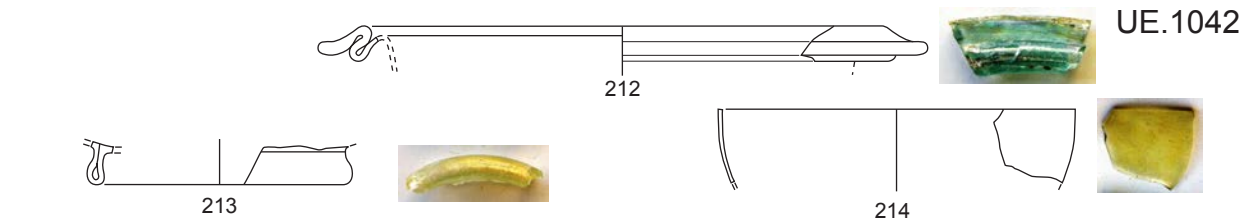

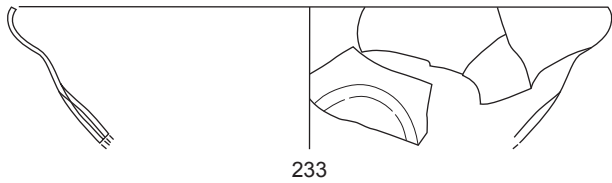

233

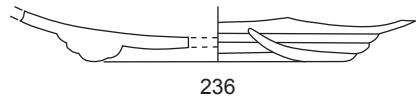

236

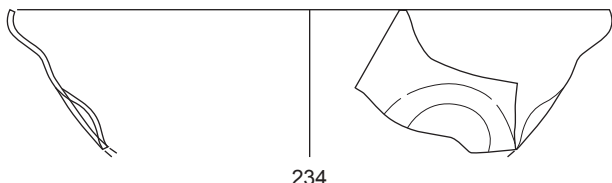

234

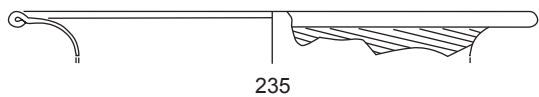

235

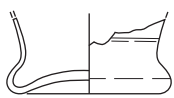

237

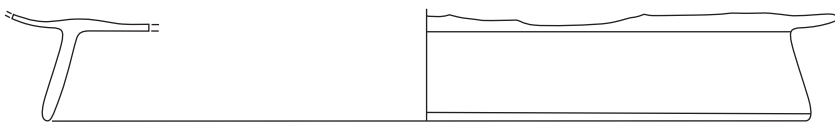

238

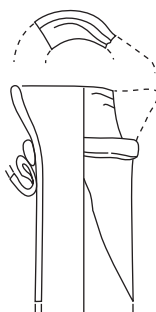

239

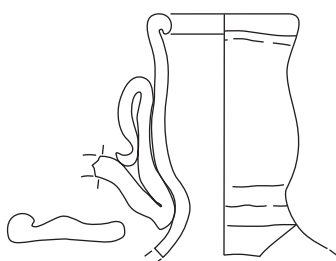
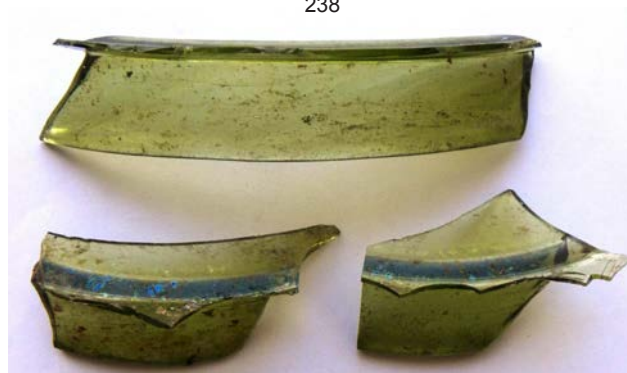

240

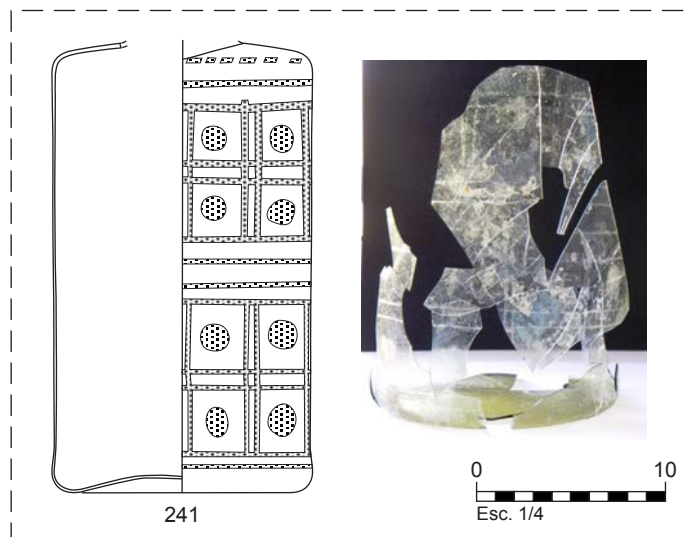

241

0 10  
Esc. 1/4



0 5 10 cm  
Esc. 1/2

UE.109

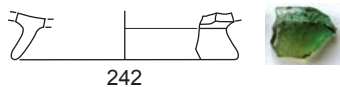

242



243

UE.111

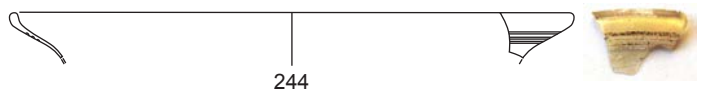

244

UE.191



246

UE.119

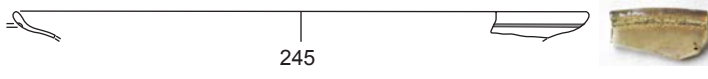

245



247

UE.445

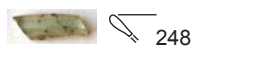

248

UE.306

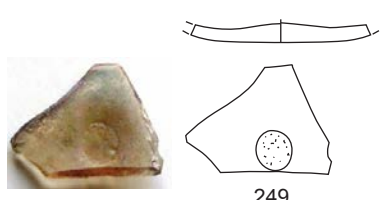

249

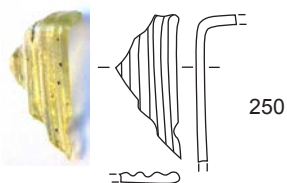

250

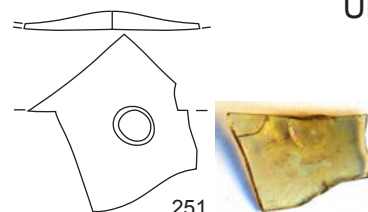

251

UE.469

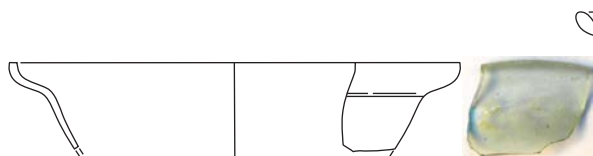

252



255

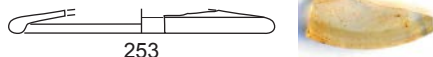

253

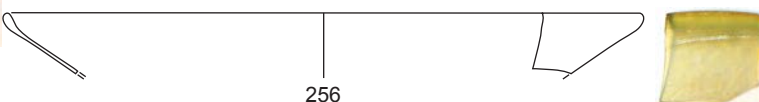

256

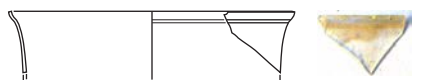

254

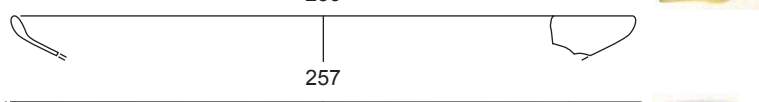

257



258

259

UE.529

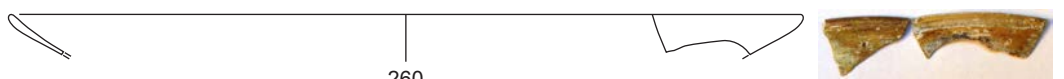

260

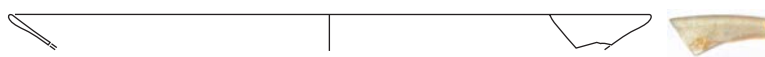

261

UE.659



262

UE.663

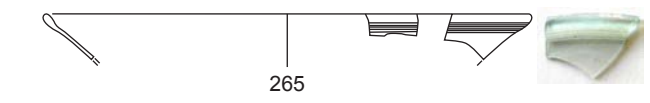

265



263



266



264



267

UE.676

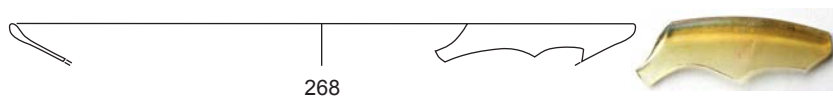

268

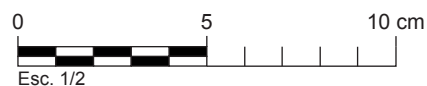

Esc. 1/2

UE.752



269

UE.780

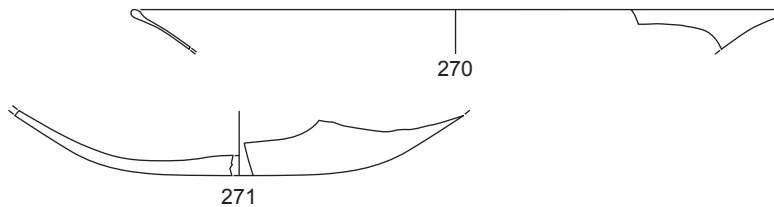

270

271



UE.839

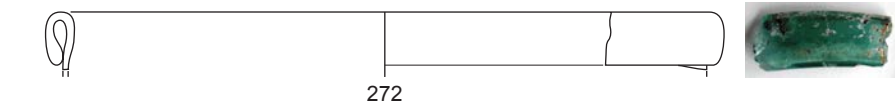

272

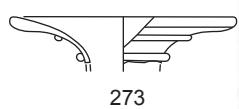

273

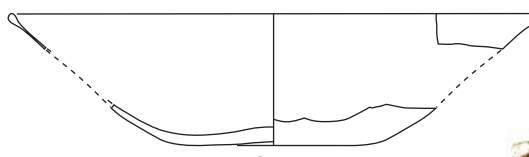

274

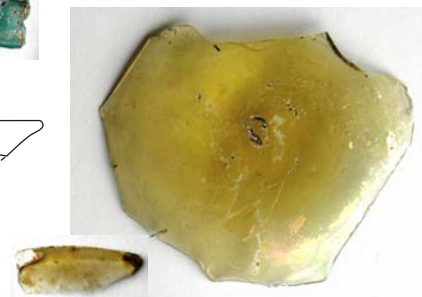

UE.852



275

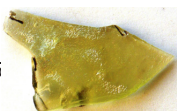

UE.862



276



UE.913



277



UE.914



278



UE.962



279

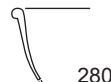

280

UE.1014



281



UE.1034



283



UE.1032

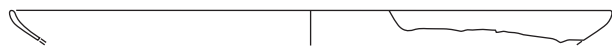

282

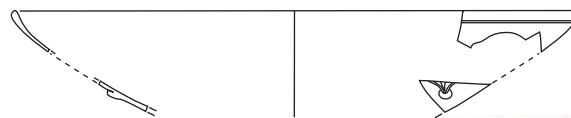

284

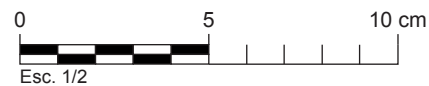
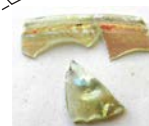



285



UE.1040



286

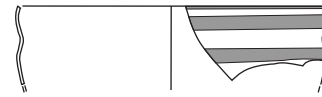

287



UE.1058

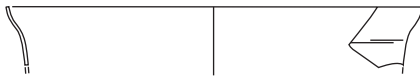

288



289

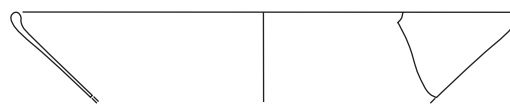

292

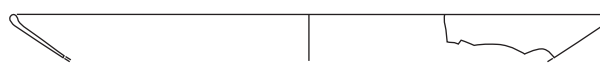

293

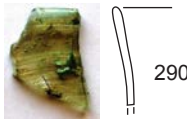

290

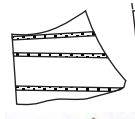

291

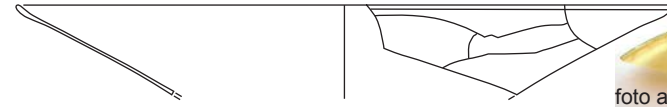
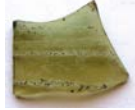

294



foto a escala 1/4

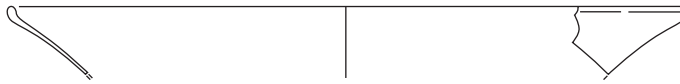

295



UE.1119



296



UE.1349



297

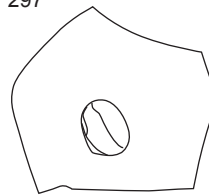

UE.1538



298



UE.1605



299



UE.1662

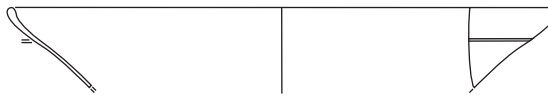

300



UE.1808



301

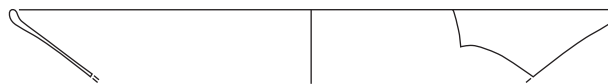

302

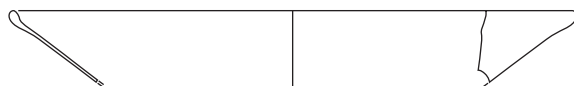

303

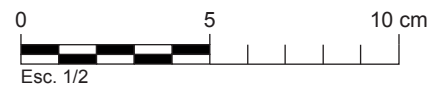

Esc. 1/2

UE.123

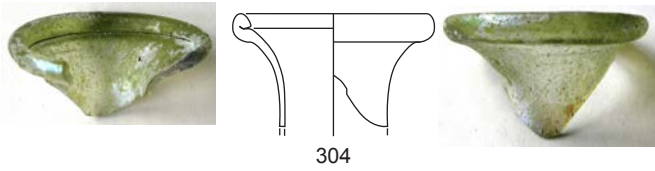

304

UE.125

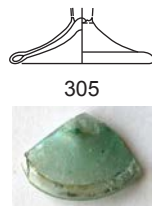

305

UE.179

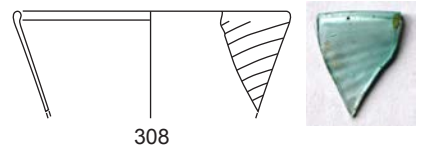

308

UE.168



306

307

UE.260

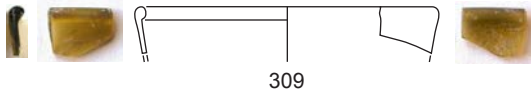

309

UE.267



310

UE.337

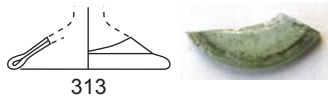

313

UE.431

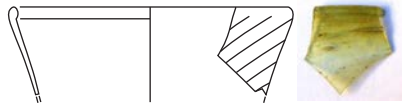

314

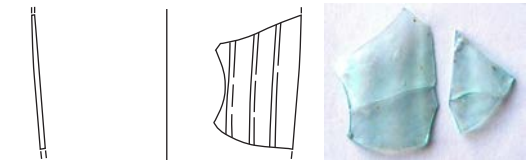

311

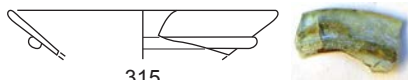

315

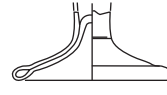

312



UE.487

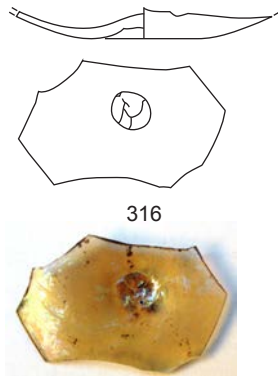

316

UE.707

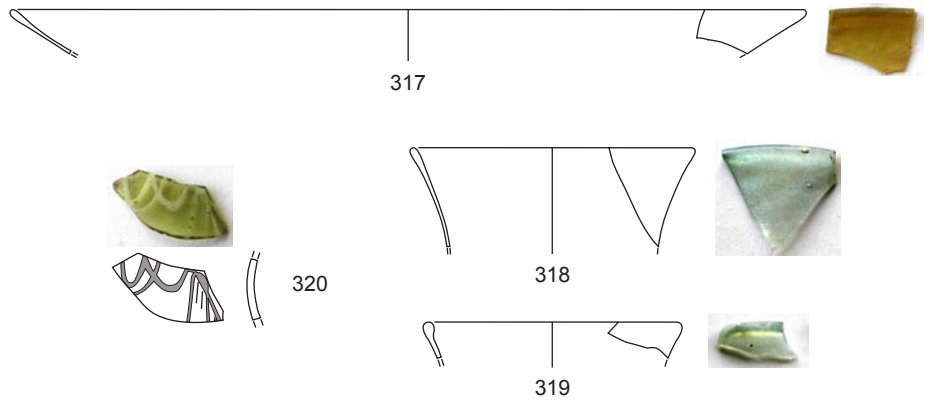

317

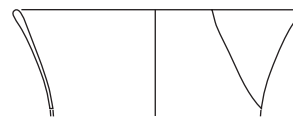

318



319

UE.715

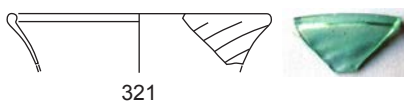

321

UE.743



322

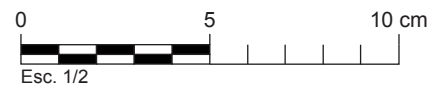



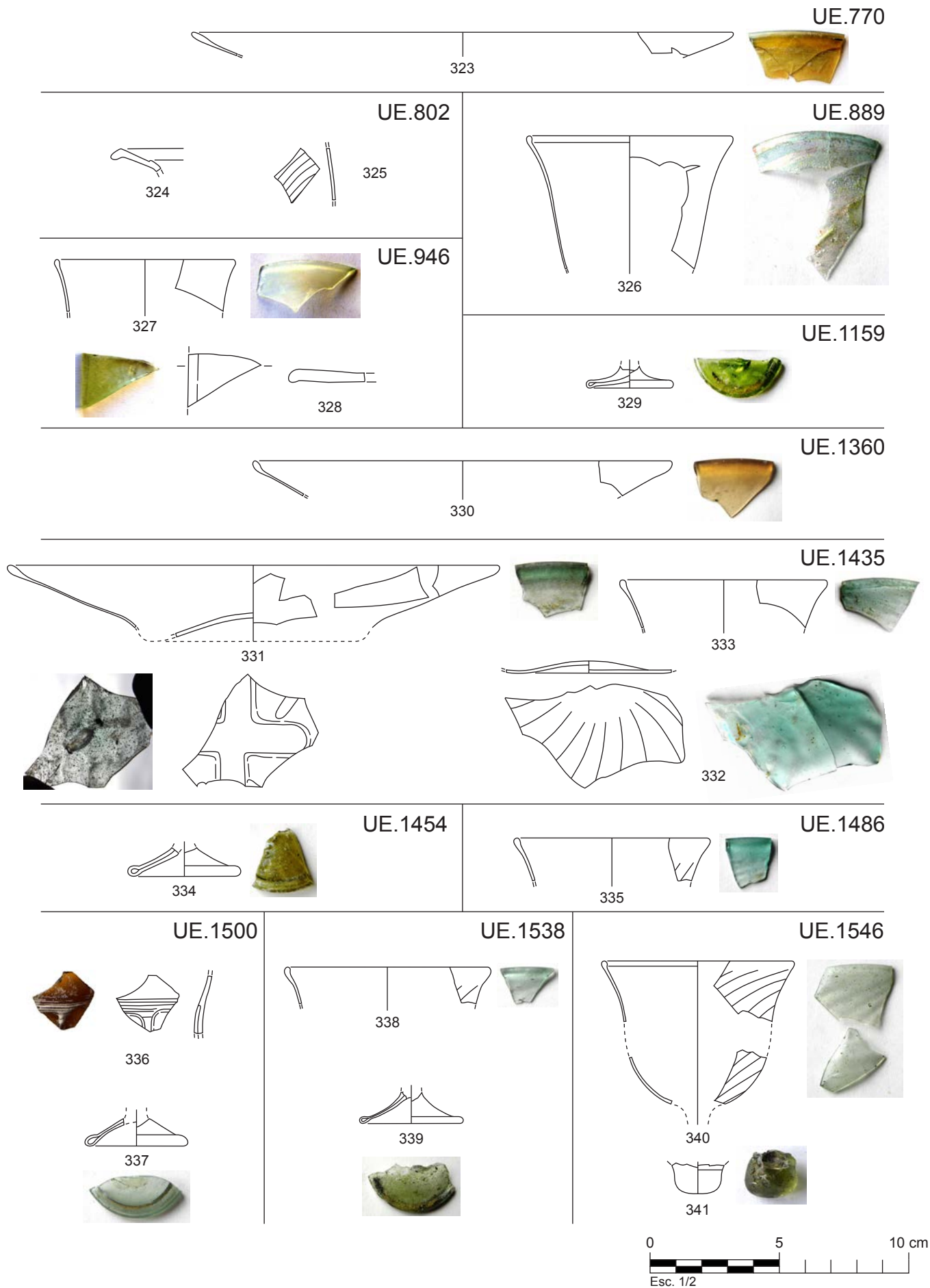

UE.1554



342



UE.1562

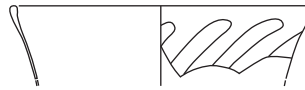

344

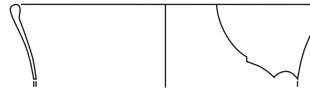

345



UE.1559

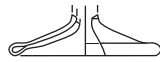

343

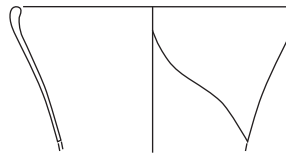

346



UE.1610

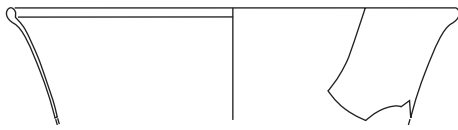

347

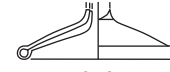

348



UE.1658

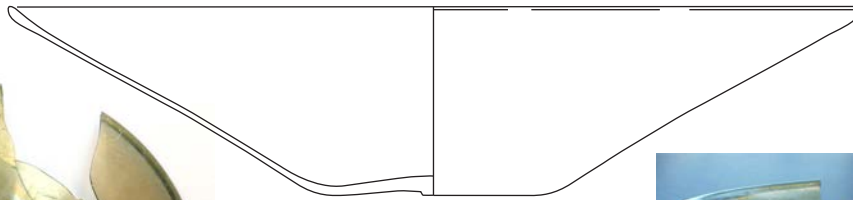

349

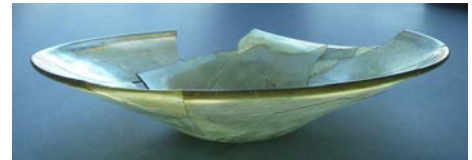

fotografia a escala 1/4

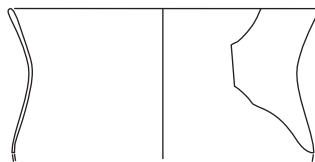

350

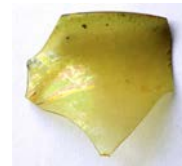

fotografia a escala 1/4

UE.1667



351



UE.1737



352



UE.2017

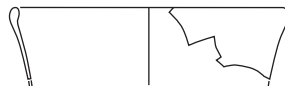

353

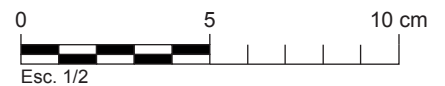

Esc. 1/2

UE.108

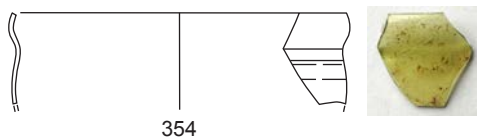

354



355

UE.113



356



UE.115

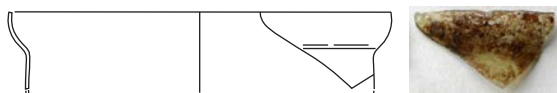

357



358

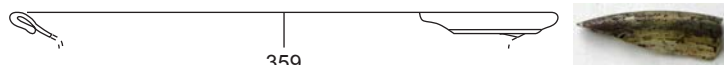

359

UE.122

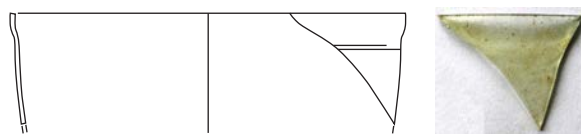

360



361

UE.125

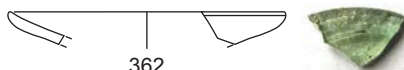

362

UE.144

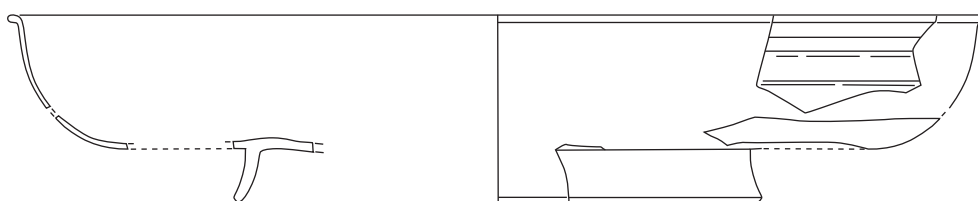

363

UE.153

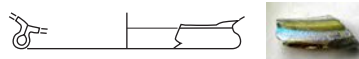

364

UE.300

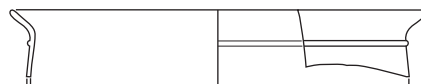

365

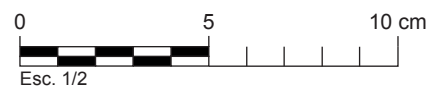

UE.1006

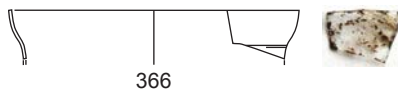

UE.1033

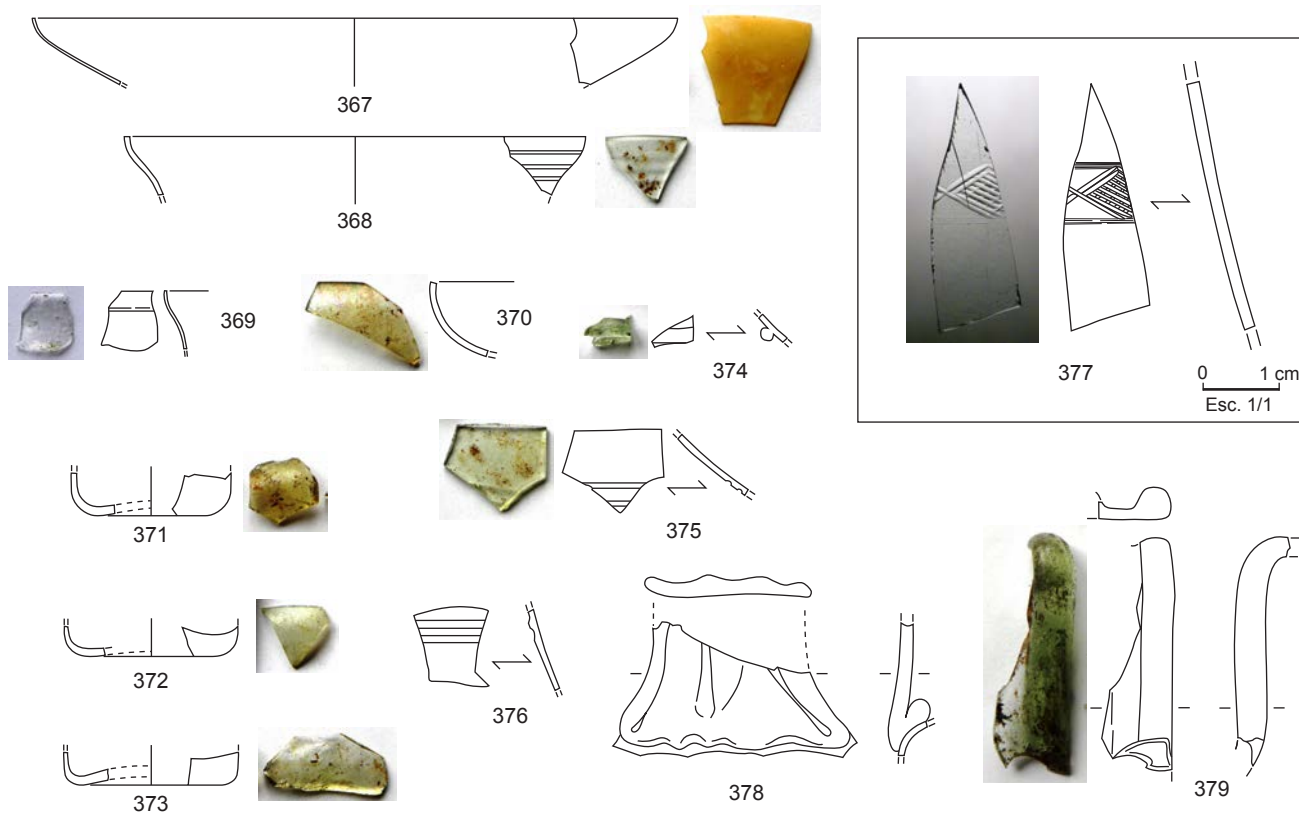

UE.1082



UE.1094

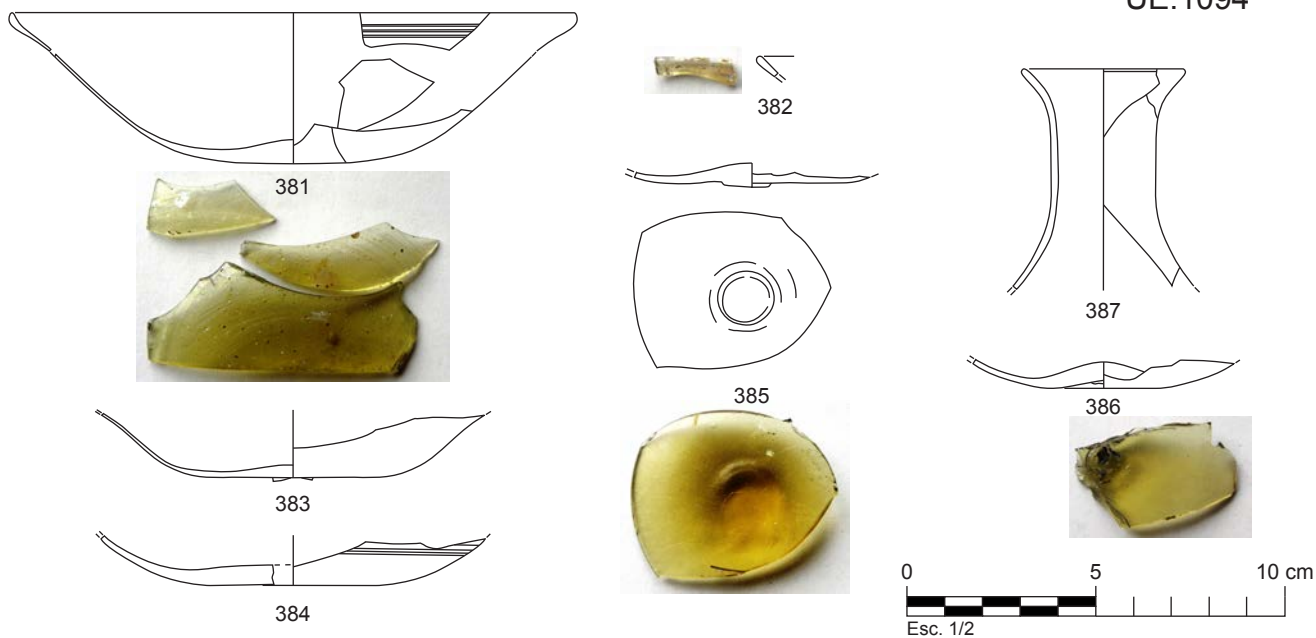

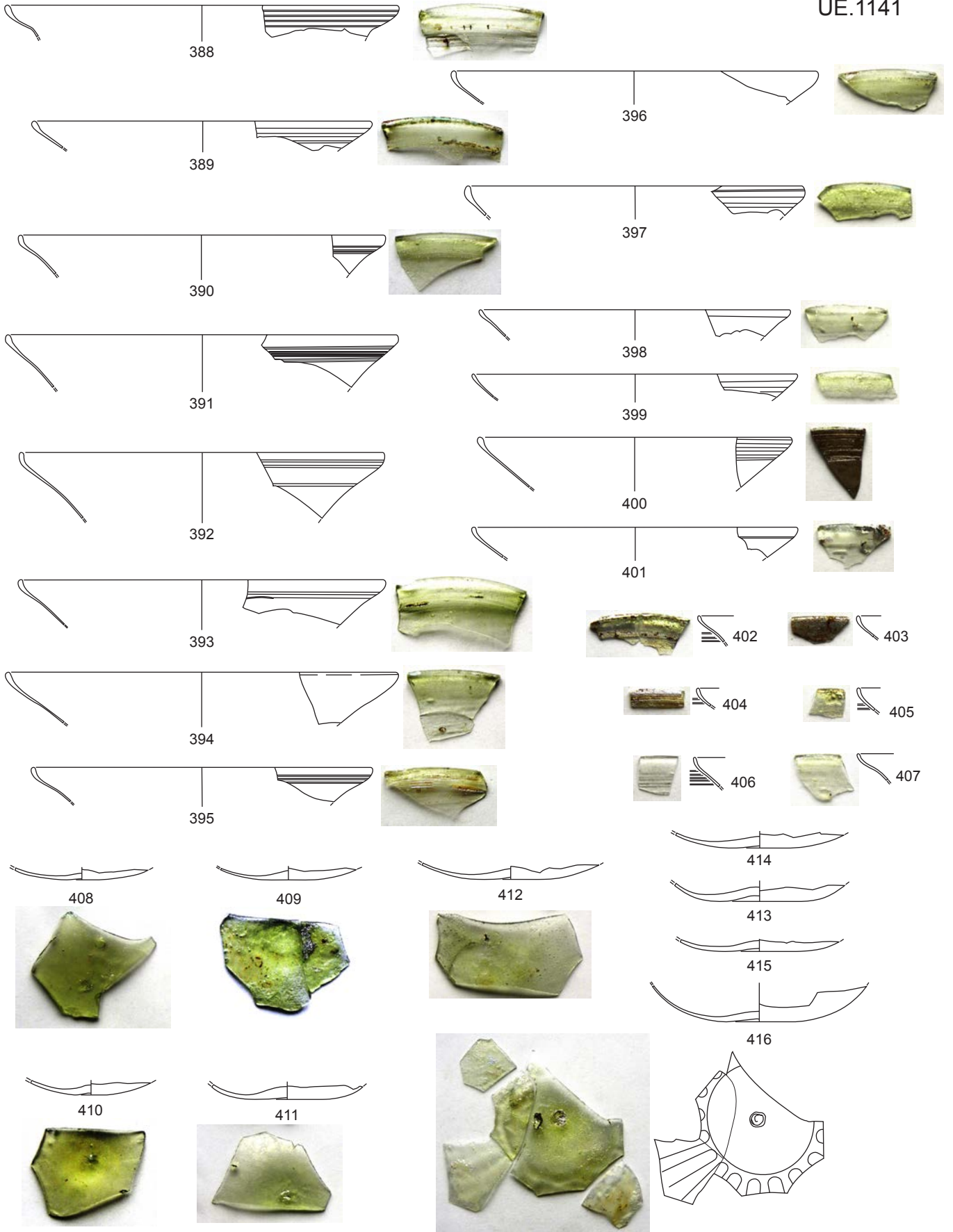

UE.1118

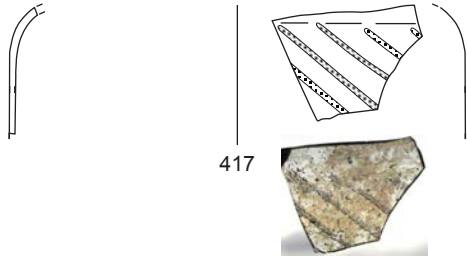

417

UE.1143

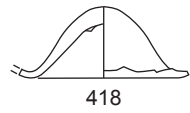

418



UE.1144

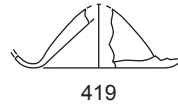

419



UE.1173

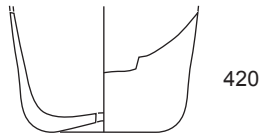

420

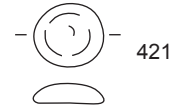

421

UE.1204

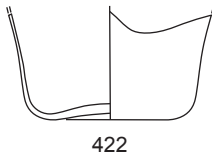

422

UE.1231

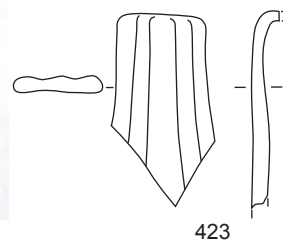

423

UE.1255



424

UE.1277

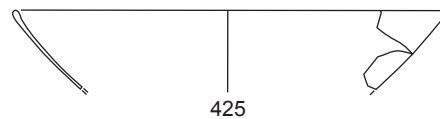

425



UF.6-UE.1047

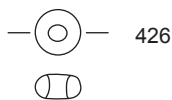

426



UF.43-UE.1346

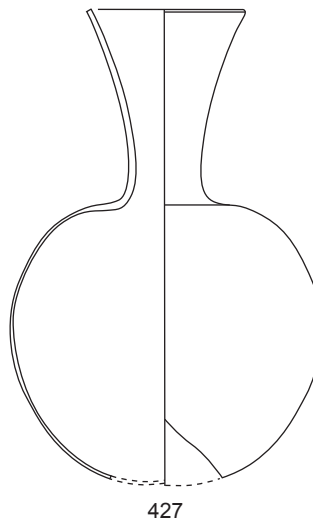

427



Fotografia MHSC-N°5252

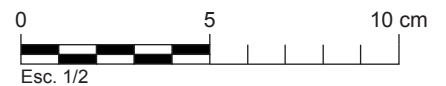

UE.26

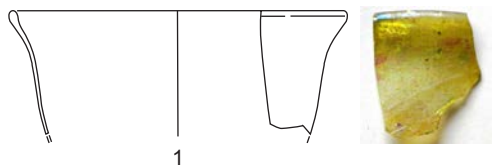

UE.96

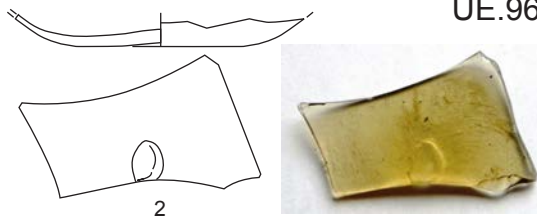

UE.100

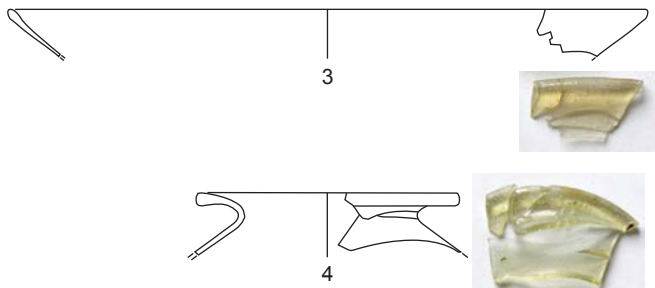

UE.105

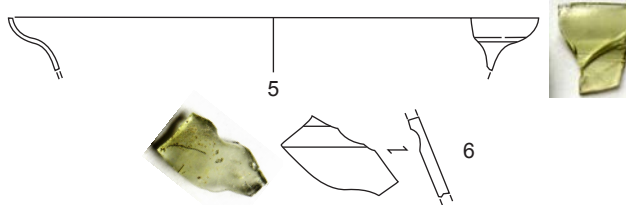

UE.107

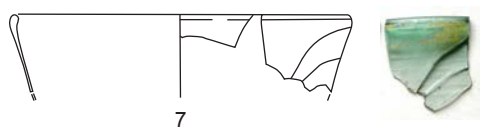

UE.248

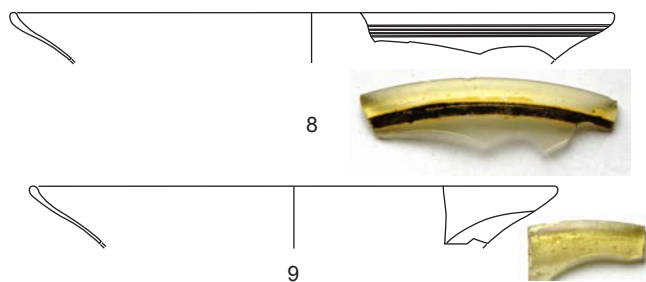

UE.538



UE.582

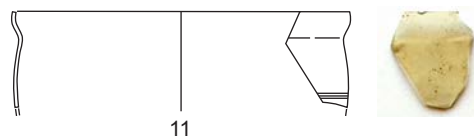

UE.624



UE.724

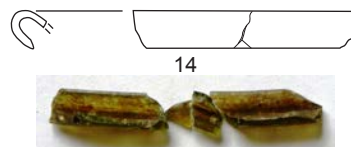

UE.738

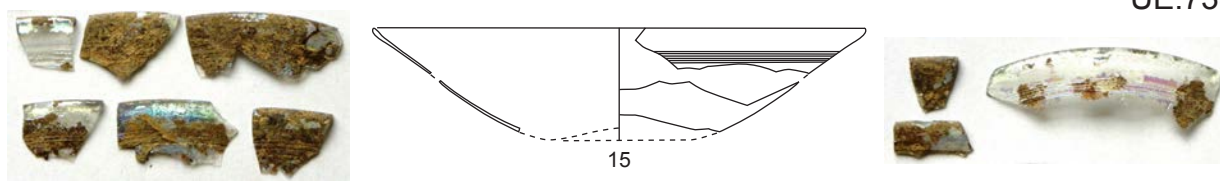

UE.755

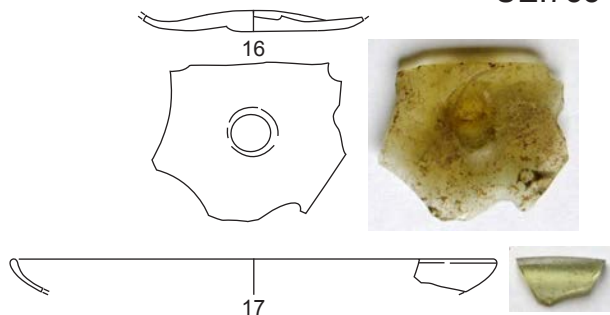

UE.768

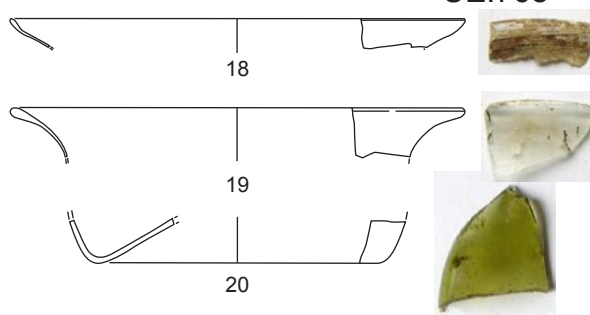

UE.793

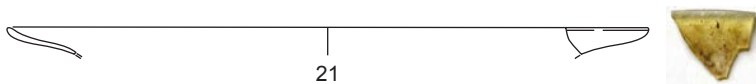

21

UE.821



22

UE.813



23

UE.823

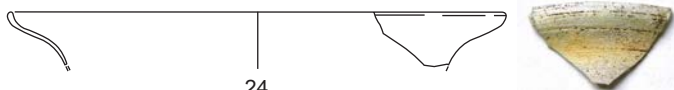

24

UE.834



25

UE.847



26

UE.849



27

UE.856

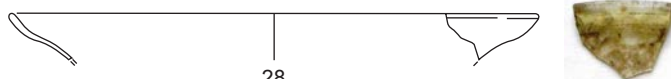

28



29



30

UE.866

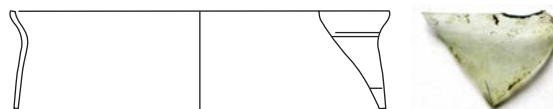

31

UE.892

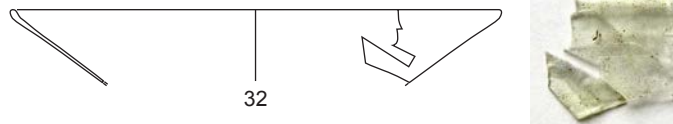

32

UE.895

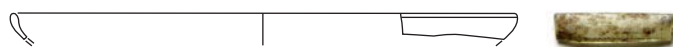

33

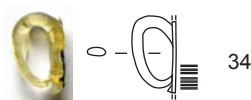

34

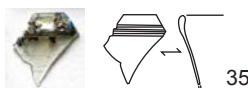

35

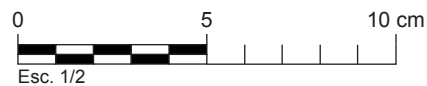



UE.318

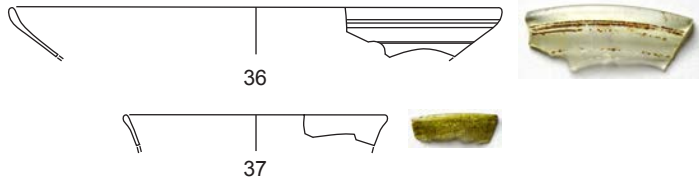

UE.337



UE.639

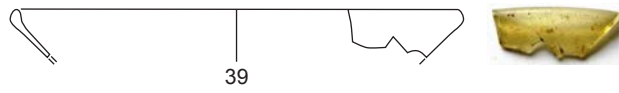

UE.517

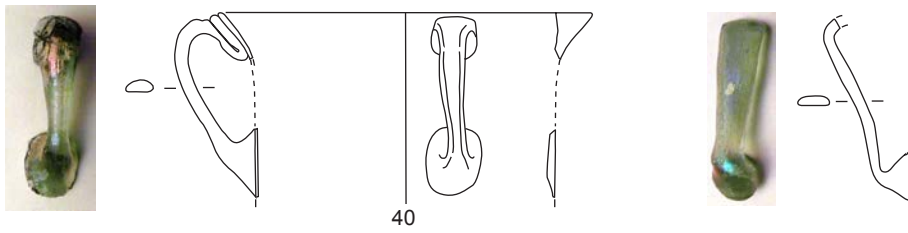

UE.523

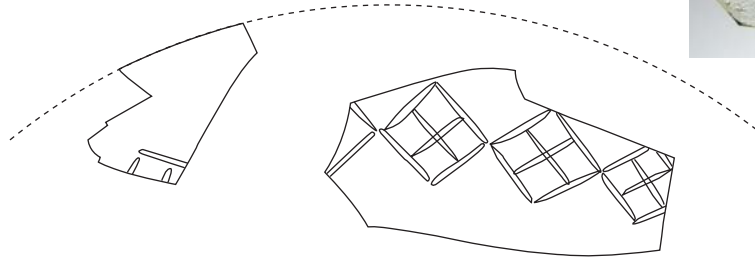
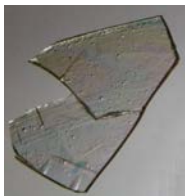
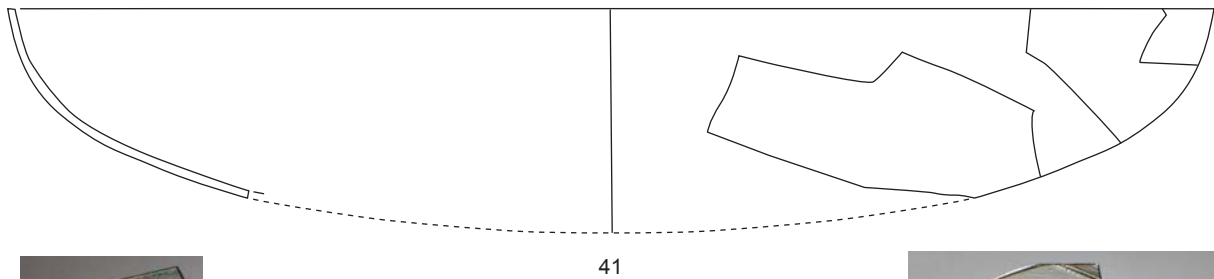

0 1 cm  
Esc. 1/1

0 5 10 cm  
Esc. 1/2

UE.2059

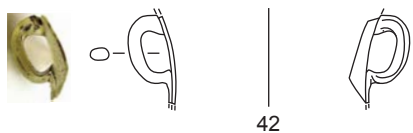

42

UE.2213



43

UE.2214



44

UE.3171

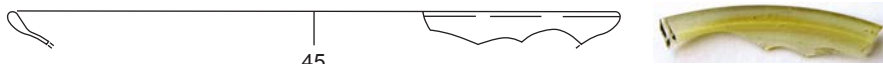

45

UE.3191

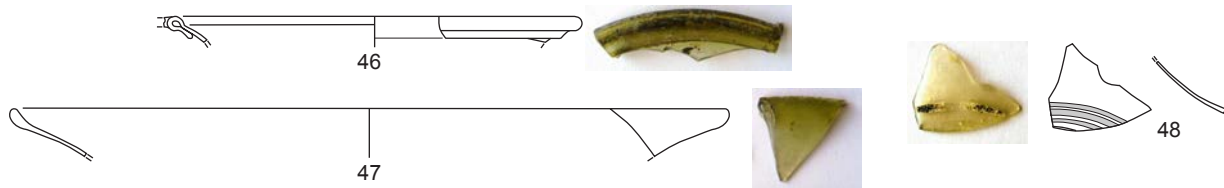

46

47

48

UE.3219

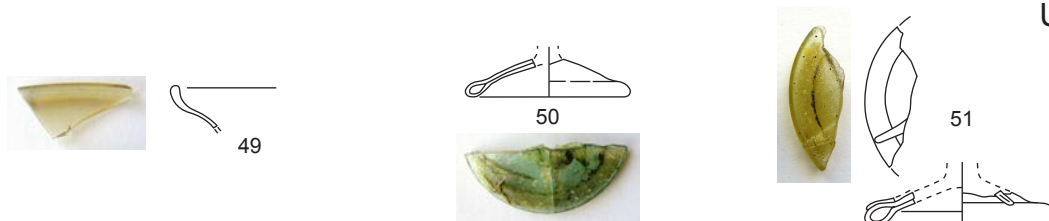

49

50

51

UE.3220



52

53

UE.3222

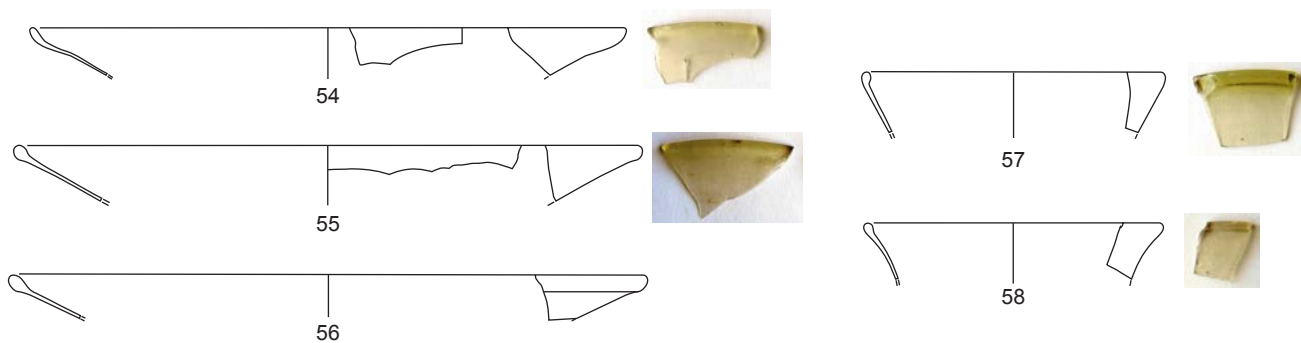

54

55

56

57

58

UE.3222-3225

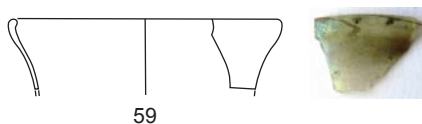

59

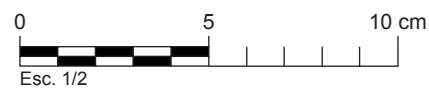

UE.176



60

UE.231

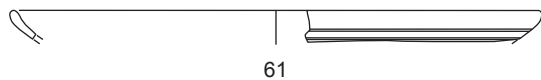

61



62

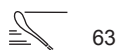

63

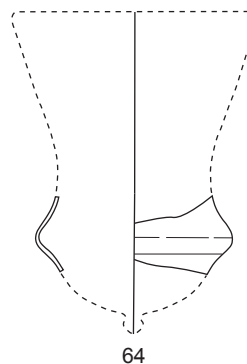

64

UE.232



65

UE.235



66

UE.241



67

UE.1041



68

UE.1210

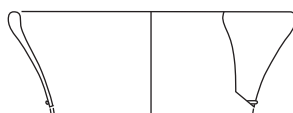

69

UE.1214

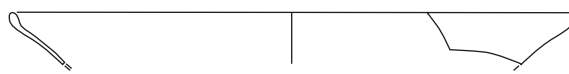

70



71

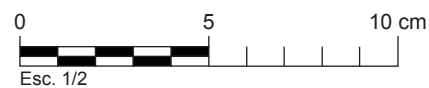

Est.20-Ue.198

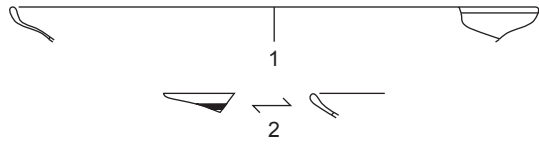

Est.21-Ue.224

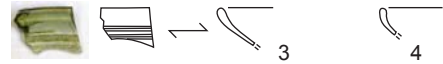

Est.31-Ues.219 i 279

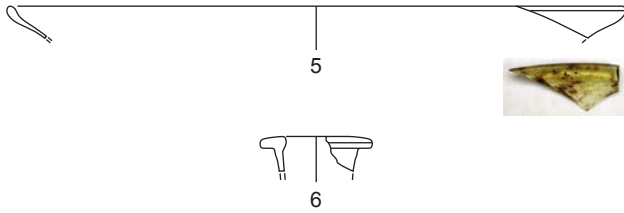

Est.36-Ue.266

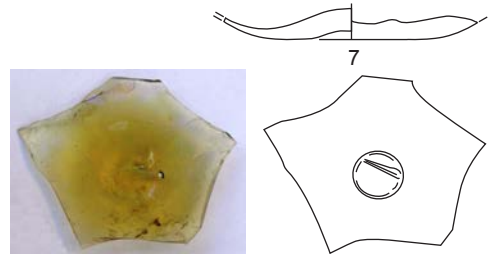

Est.38-Ue.261

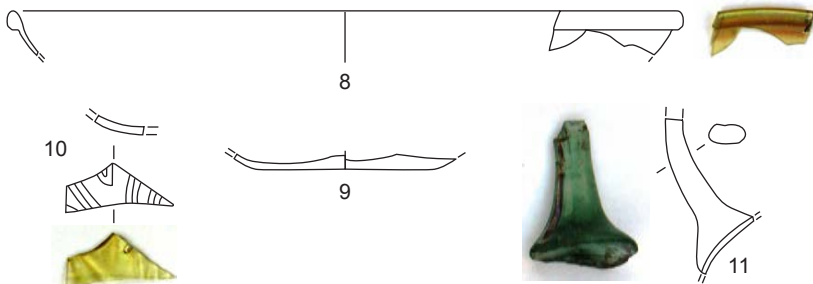

Est.40-Ue.278

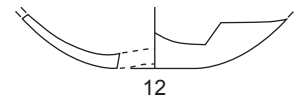

Est.42-Ue.254

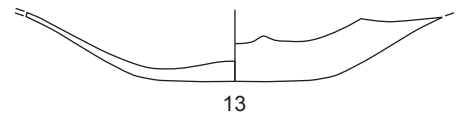

Est.43-Ue.274

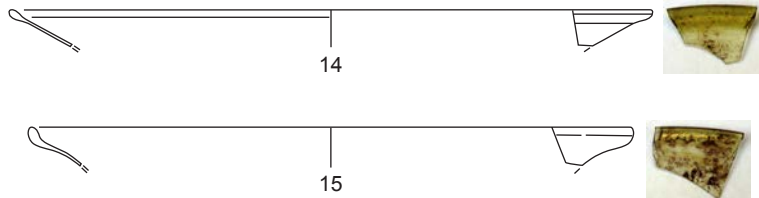

Est.49-Ues.288 i 290

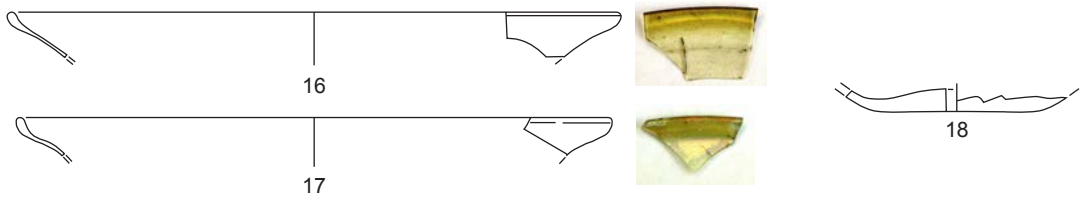

Est.69-Ue.114



Est.72-Ue.112

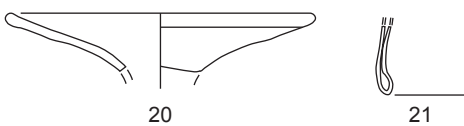

Est.73-Ue.180

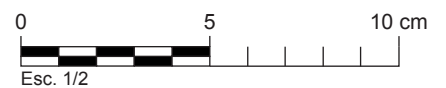
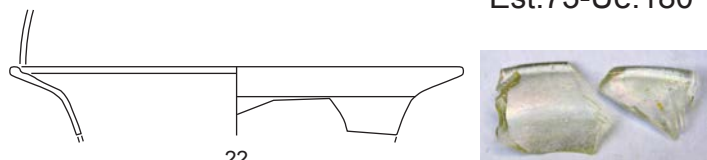

Est.87-Ue.164

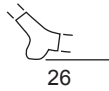
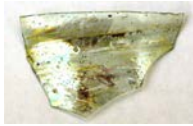
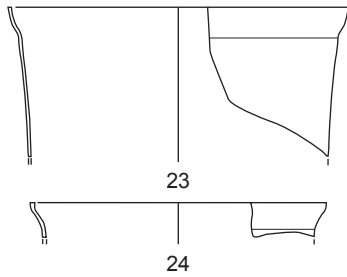

Est.92-Ue.220

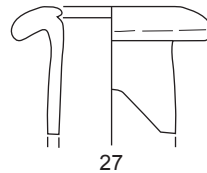

Est.92-Ue.246

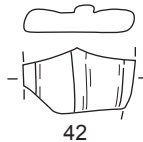
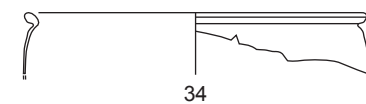
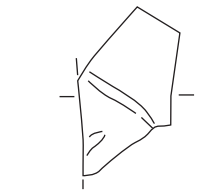
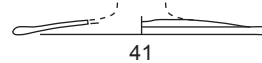
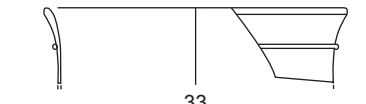
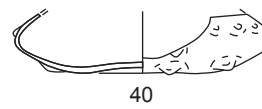
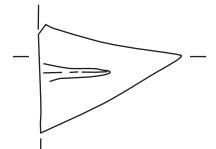
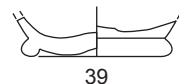
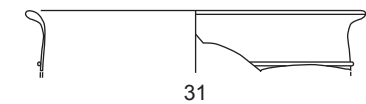
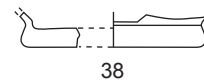
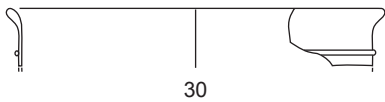
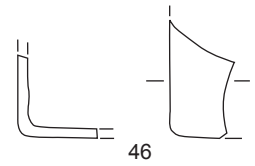
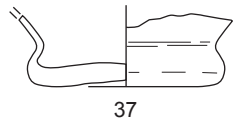
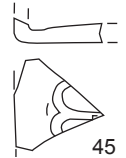
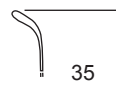
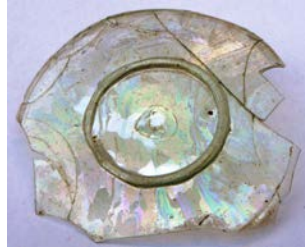
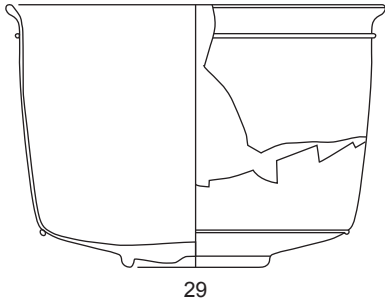

Est.93-Ues.295 i 297

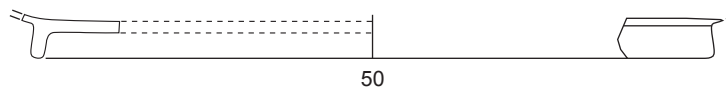
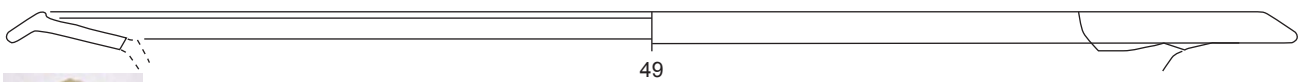

Est.94-Ues.118 i 122

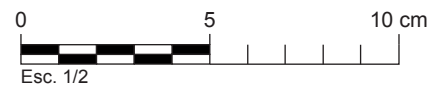
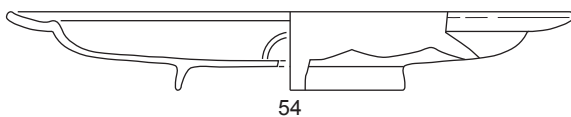
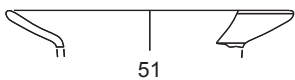

Via Augusta 129 (Sant Cugat del Vallès)

UE.48

UE.67

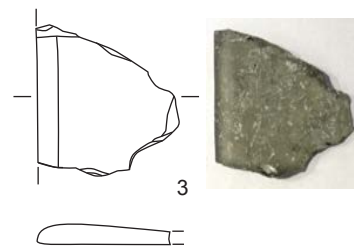
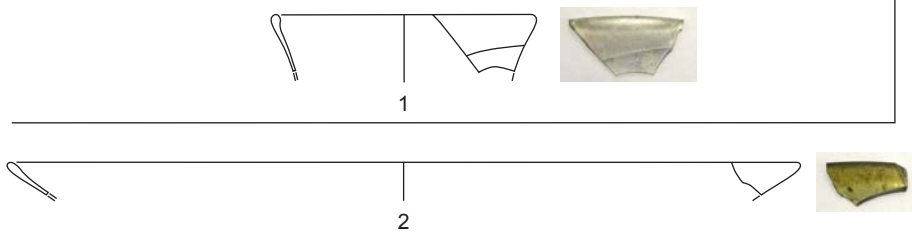

Can Sant Joan Nord 2000

UE.01

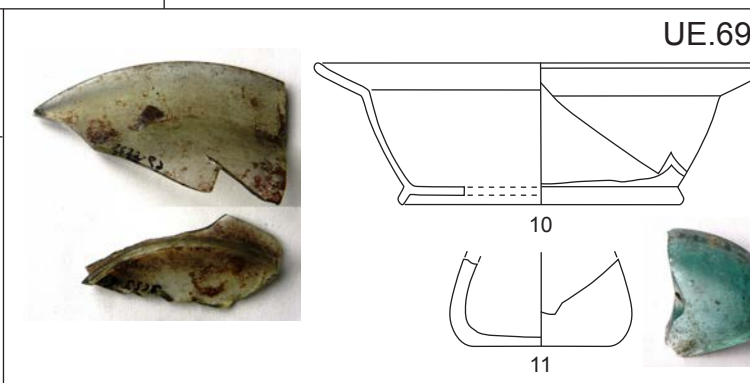
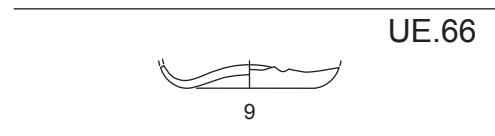
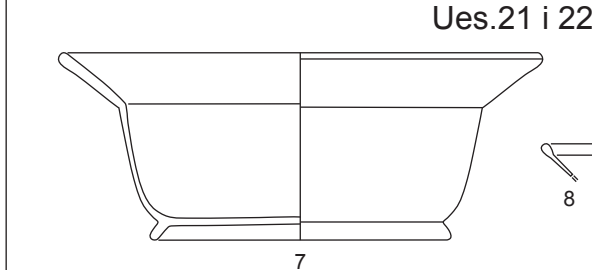
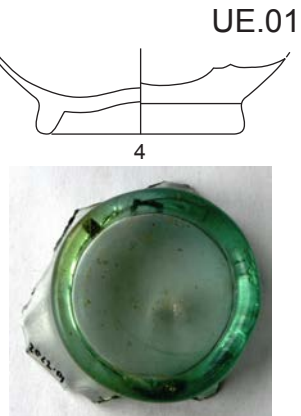
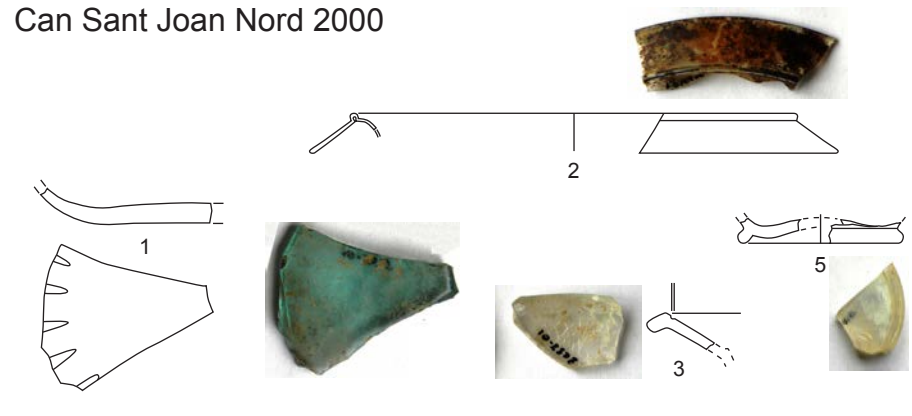

Can Sant Joan Sud-Est 2008

Est.5-UE.114

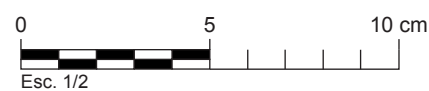
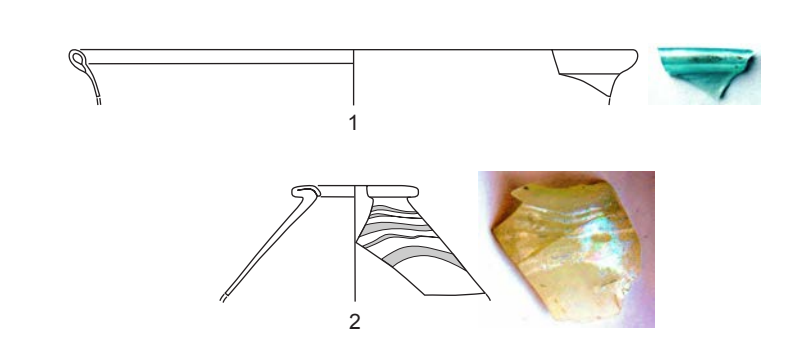

UE.3152

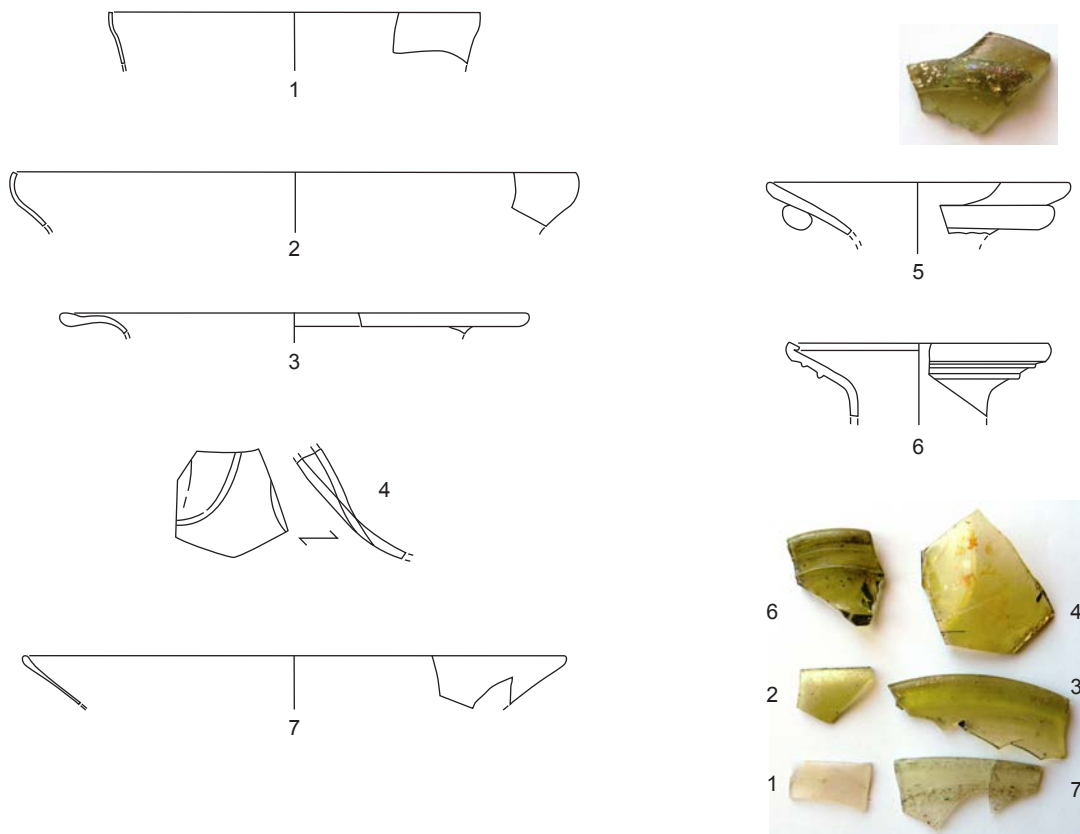

UE.3065

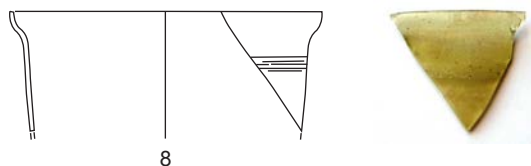

UE.3131



UE.3261

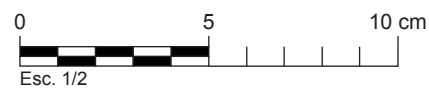
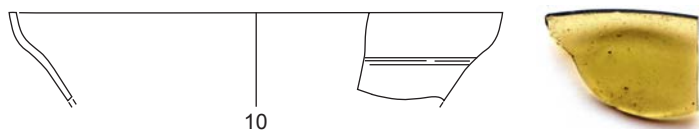

UE.3007

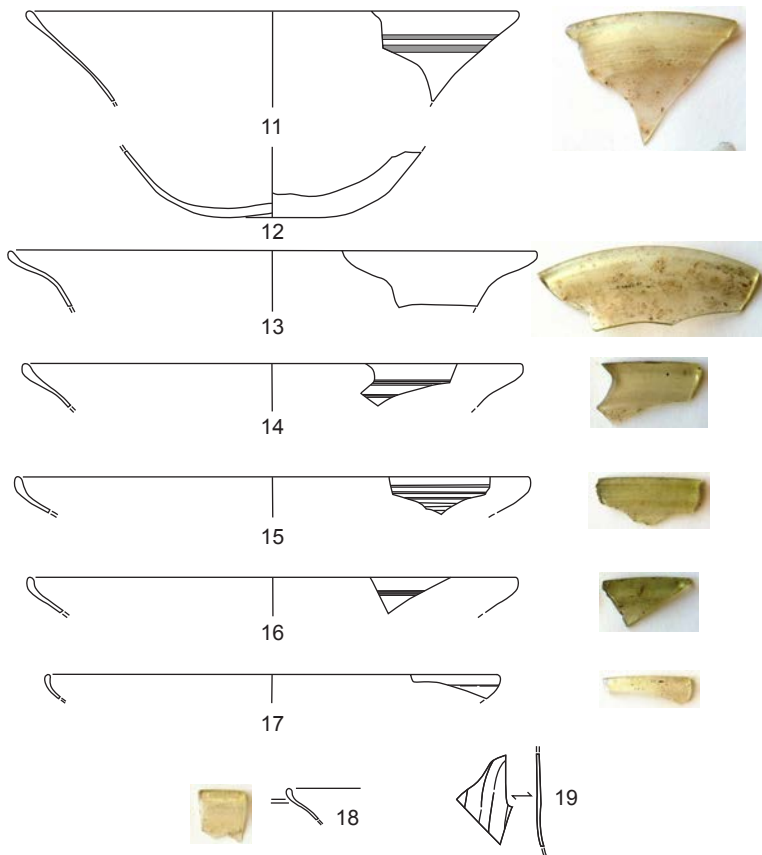

UE.3455

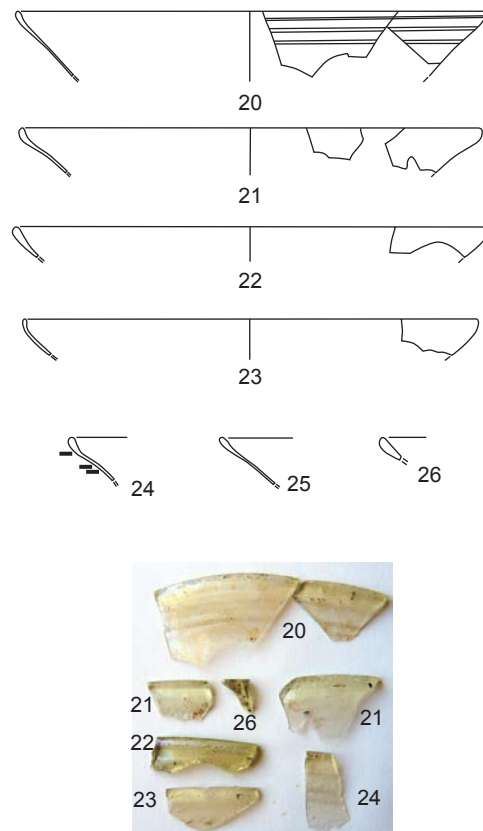

UE.3018

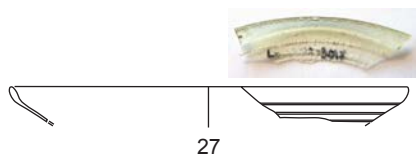

UE.3160

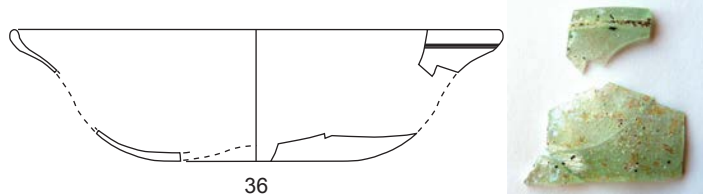

UE.3151

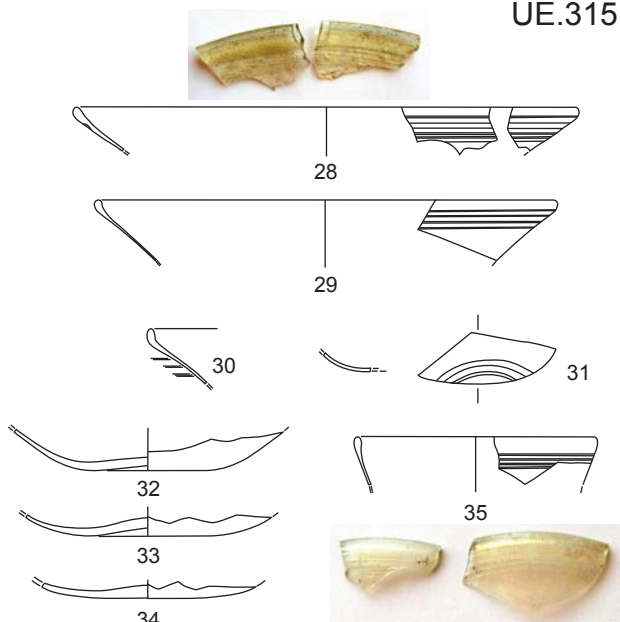

UE.3250

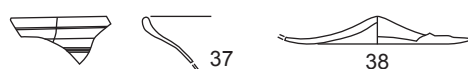

UE.3251

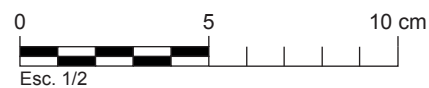
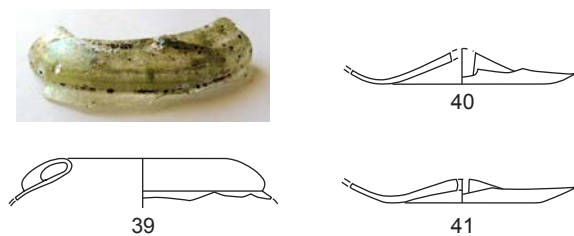



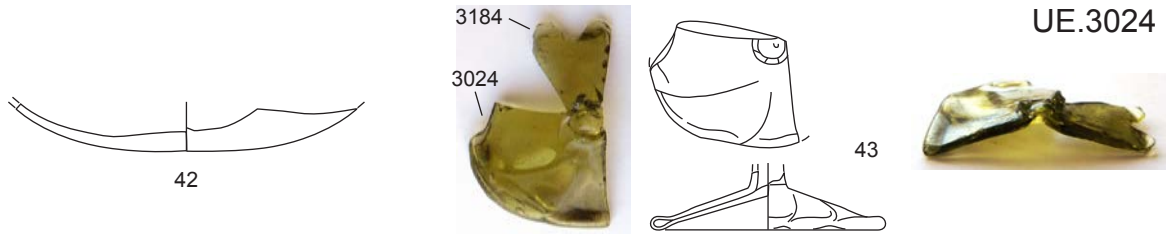

UE.3024

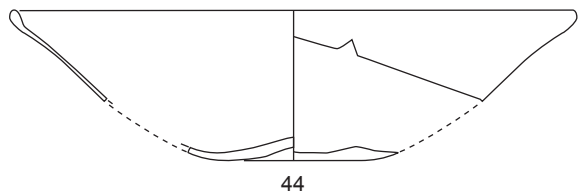

UE.3057

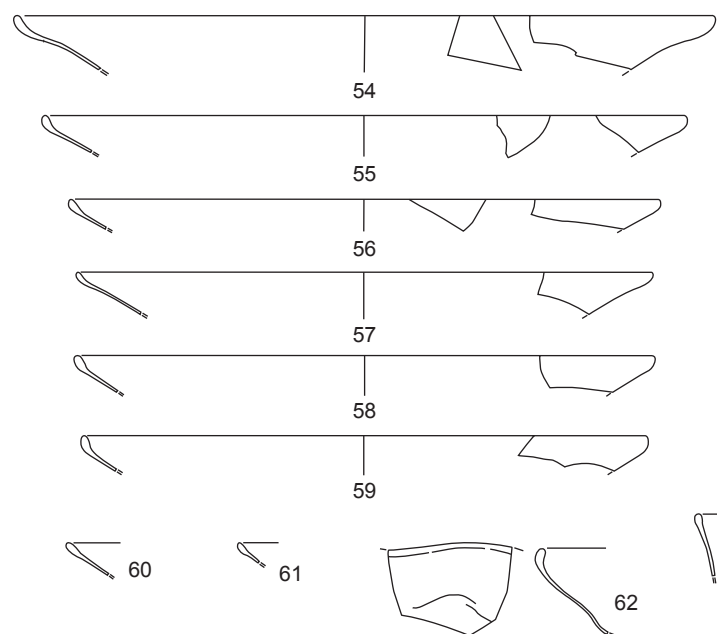
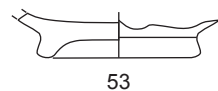
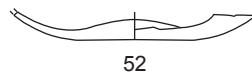
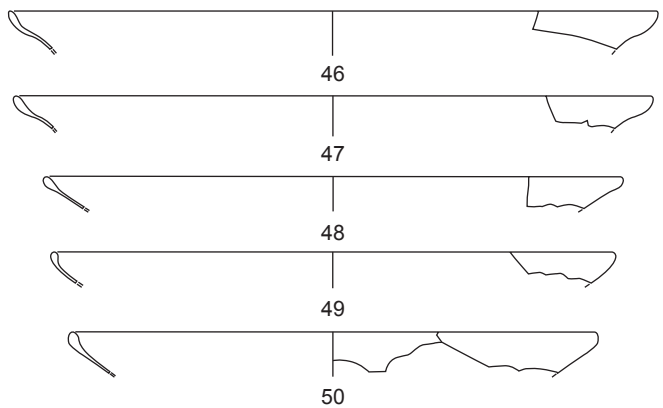
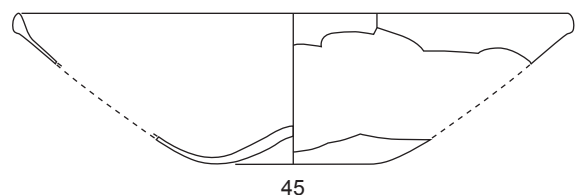

UE.3184

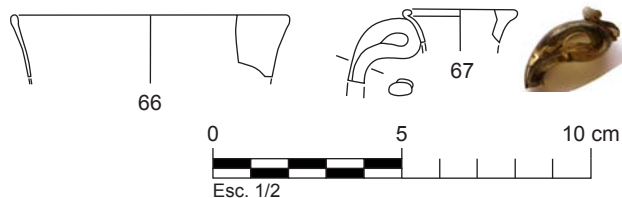
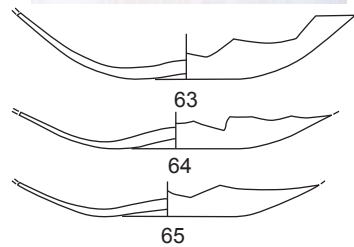

UE.3227

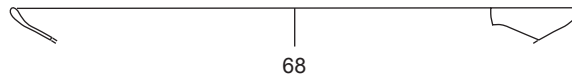

68

UE.3170

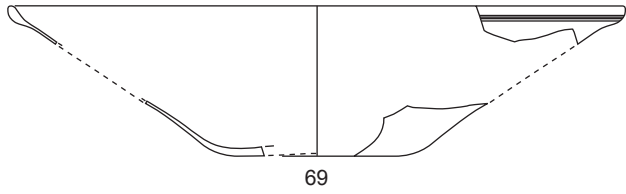

69

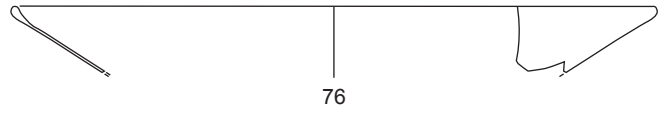

76

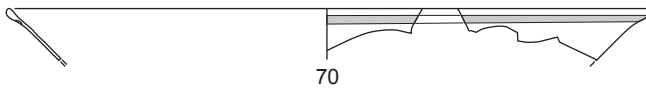

70

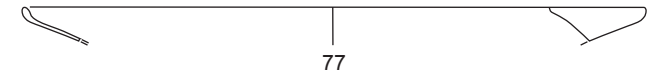

77



71

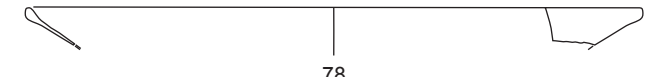

78

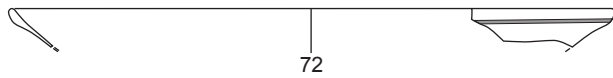

72

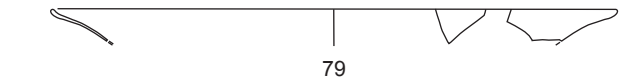

79

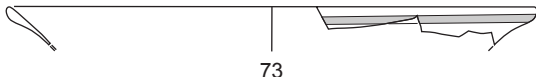

73

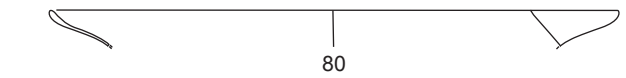

80

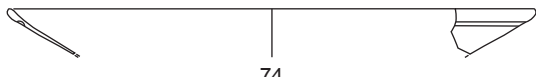

74

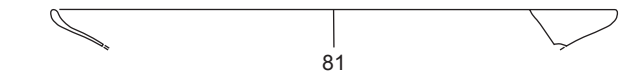

81



75



82



83



84



85



86



87



88

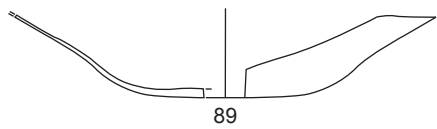

89

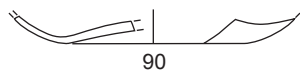

90



91

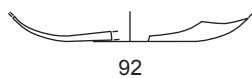

92

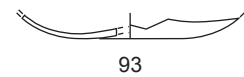

93



76

72

70

82

5 CM

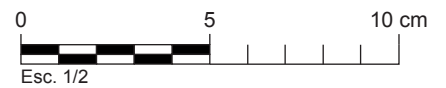

Esc. 1/2

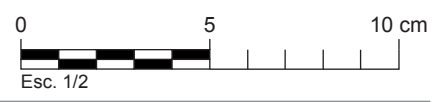
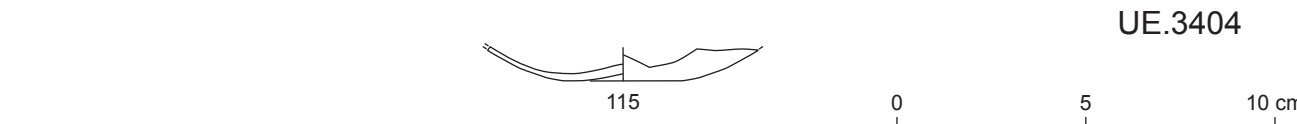
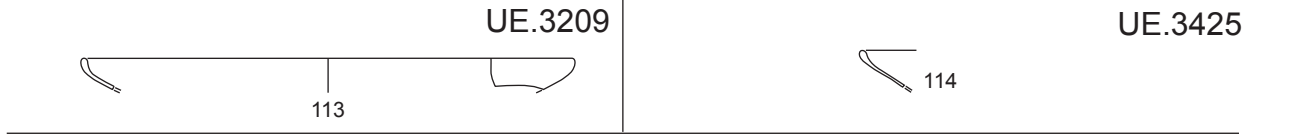
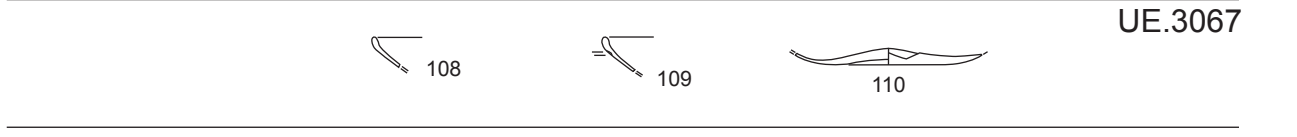
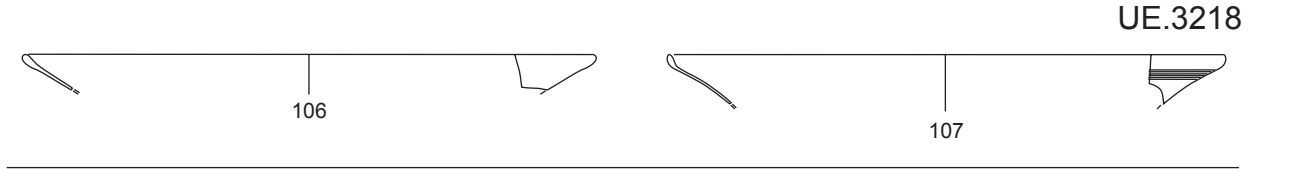
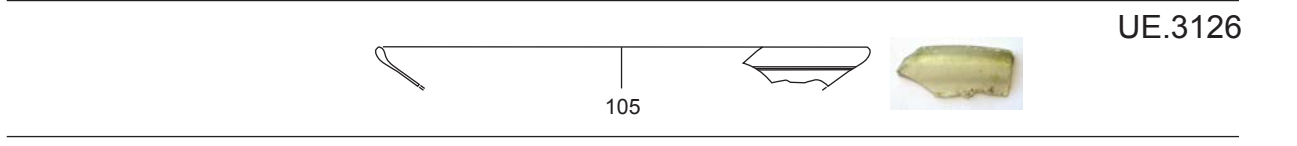
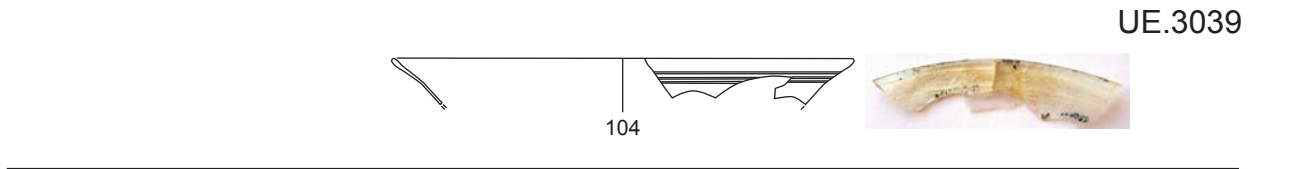
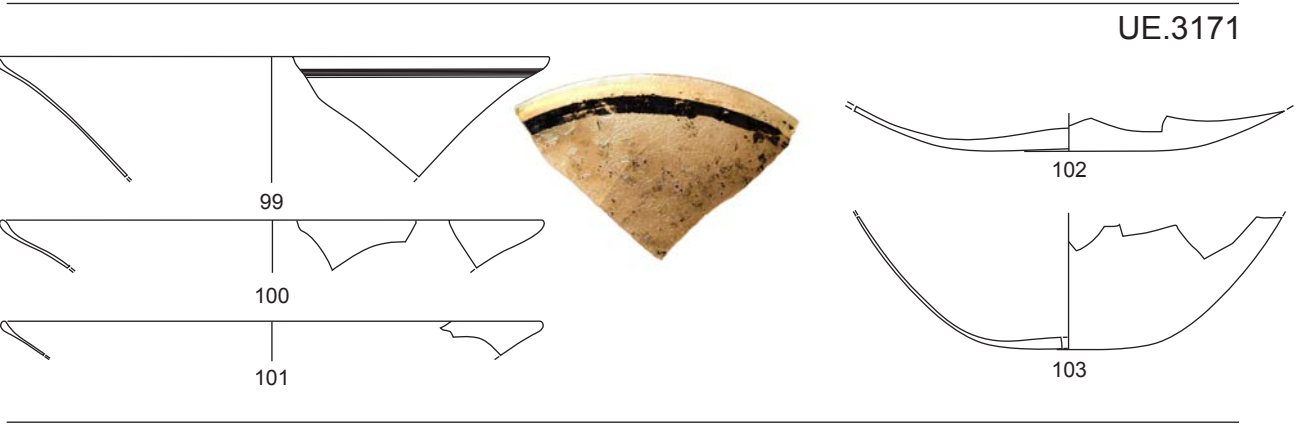
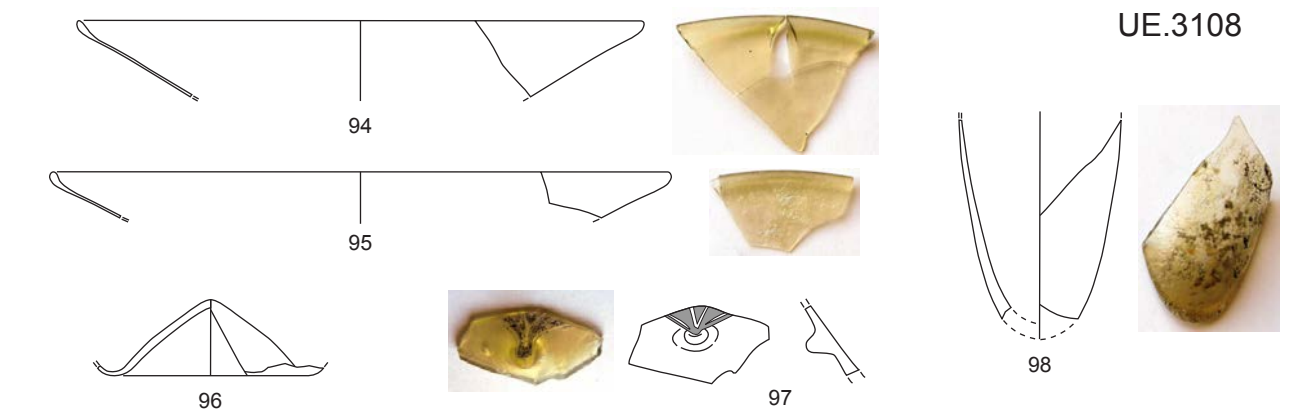

UE.3075



116

UE.3106



117

UE.3262

UE.3094

UE.3212



118



119

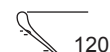

120

UE.3238

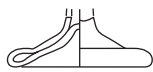

121



UE.3112



122

UE.3226

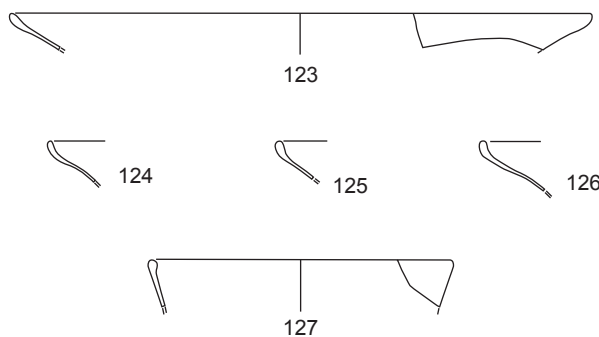

123

124

125

126

127



127

125

126

123

5 CM

UE.3006

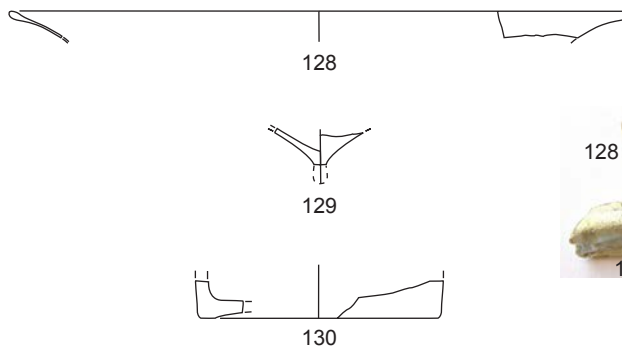

128

129

130



128

130

129

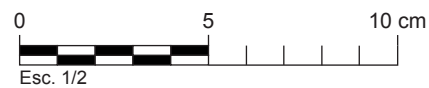

Esc. 1/2

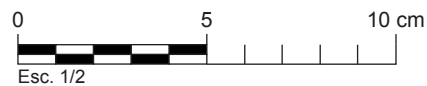
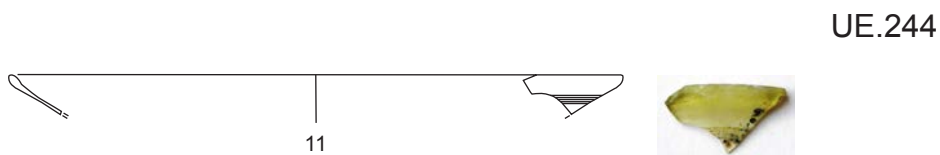
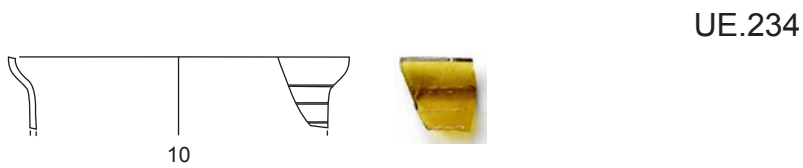
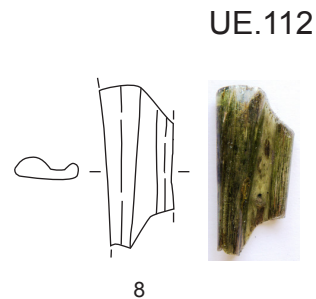
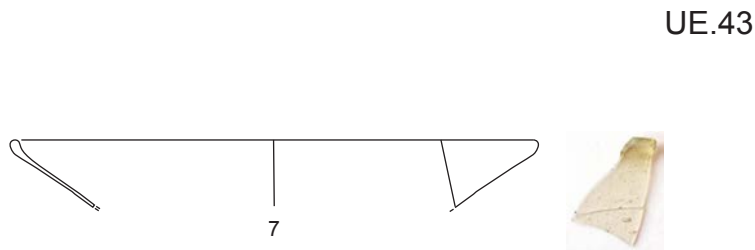
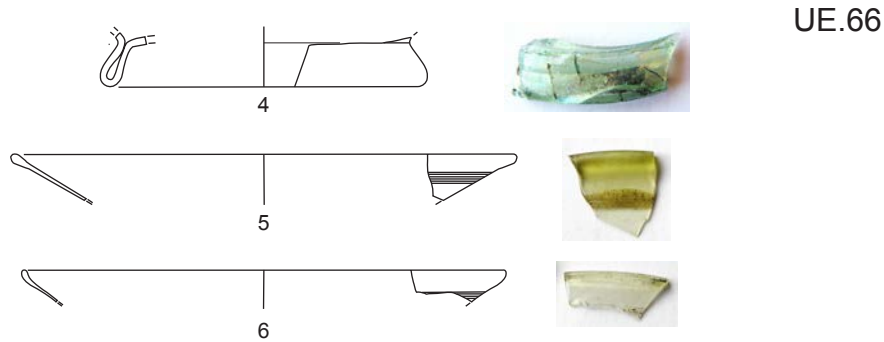
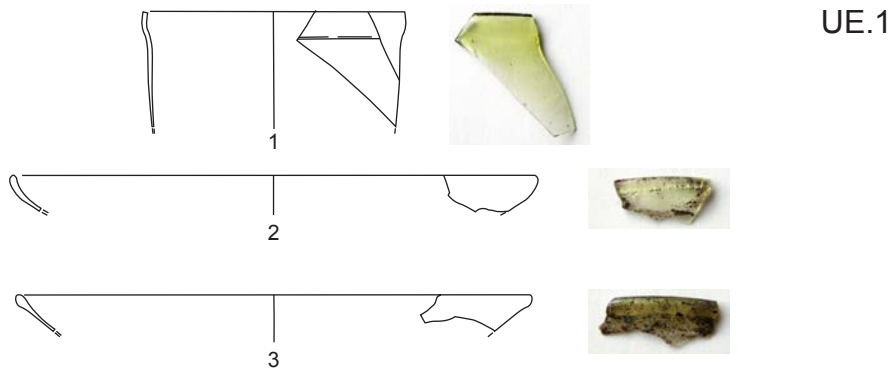

UE.45

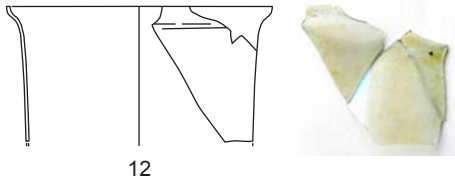

UE.50

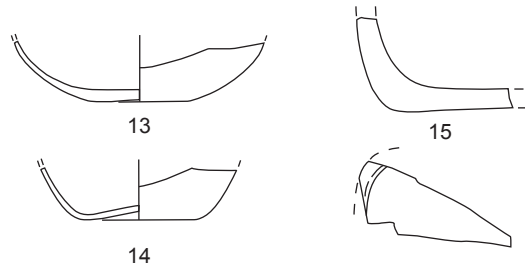

UE.74

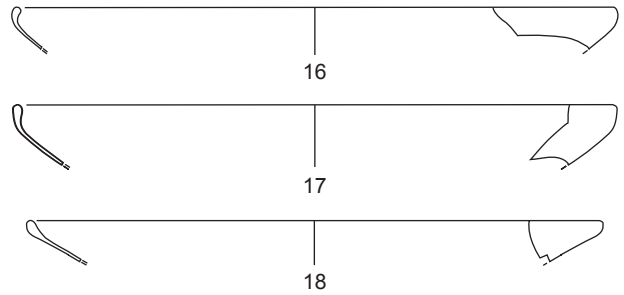
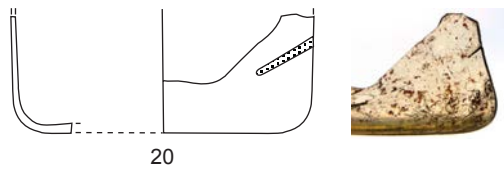

UE.104

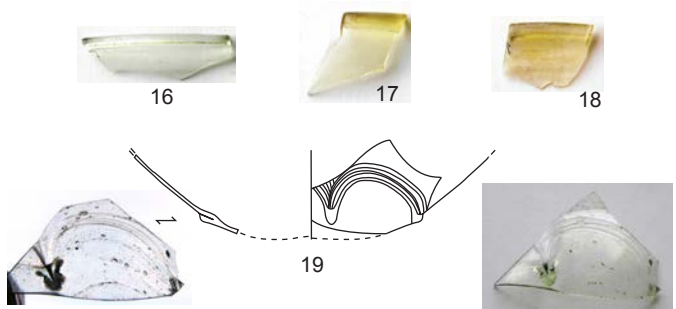
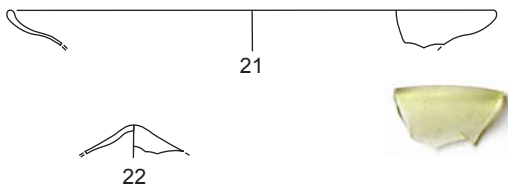

UE.102

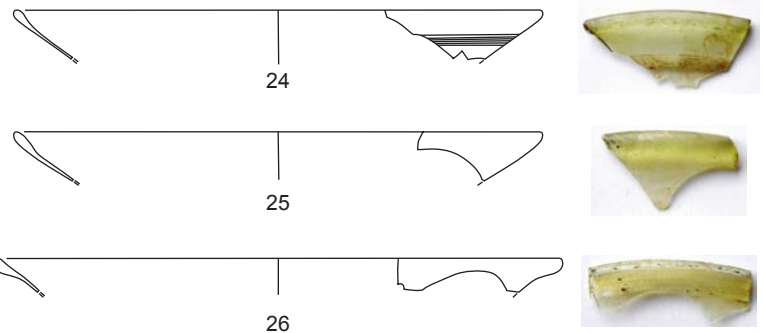
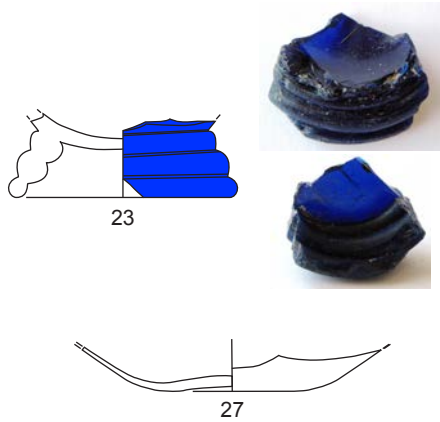

UE.319

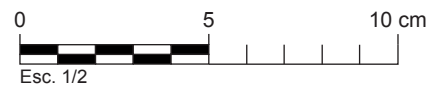
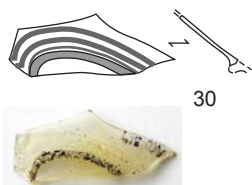
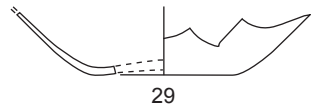

C/Doctor Turró, 8

UE.11

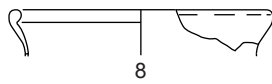
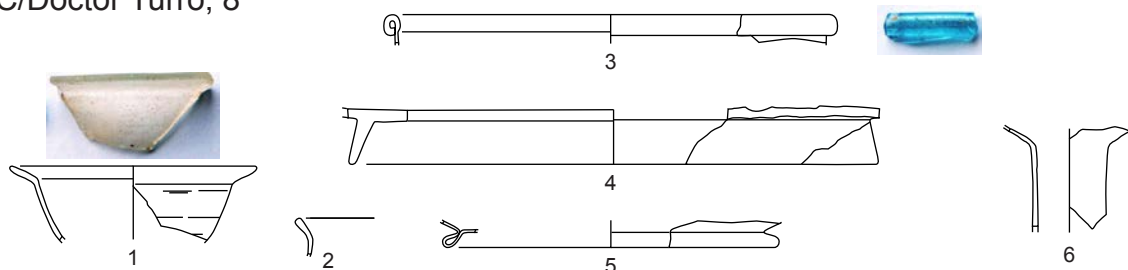

UE.12

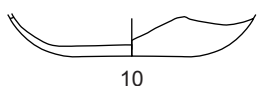

UE.28

C/ Sant Ignasi

UE.4

UE.38

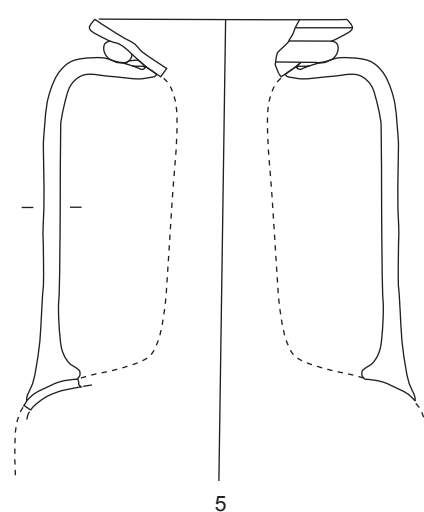

UE.10



UE.32

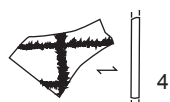

Carretera de Sabadell 83/85

UE.39



UE.132

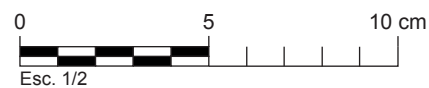

Santa Maria d'Ègara 1947

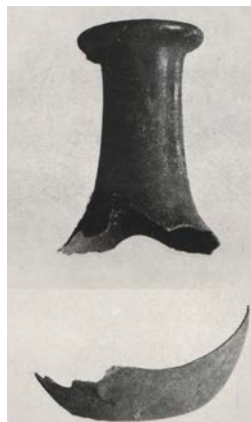
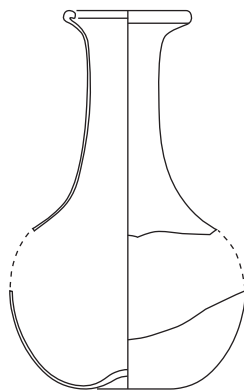

Fotografia de  
J. de C. Serra-Ràfols  
1950

Seu Episcopal d'Ègara 1995

UE.1029

UE.1071

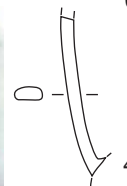
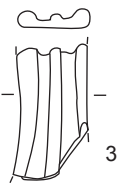

5



UE.2030

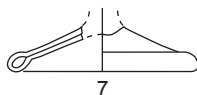

UE.2033

Seu Episcopal d'Ègara 1996-1997

UE.3260

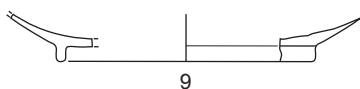

10



UE.4170

UE.5150

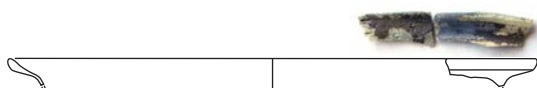

12

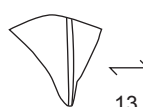
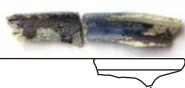

13



14

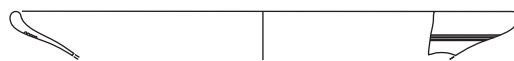

15

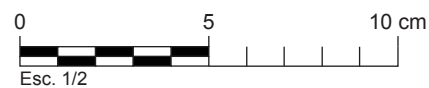
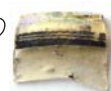



UE.7025



UE.7044



UE.7058

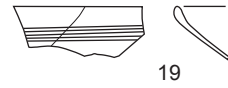
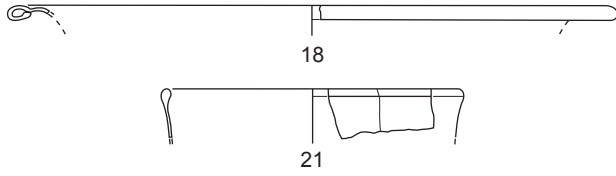

UE.7093



UE.7153

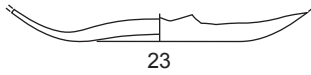

UE.7154



UE.7175

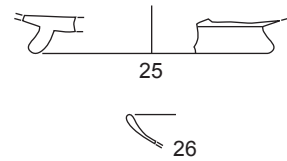

UE.7298

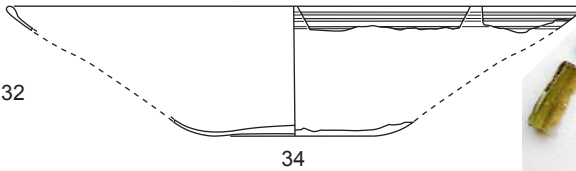
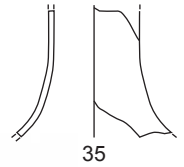
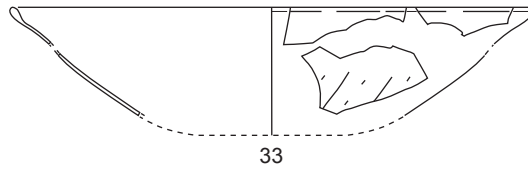

UE.7344

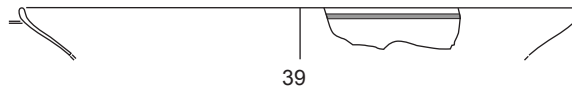
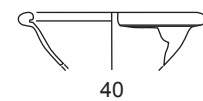
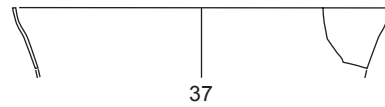
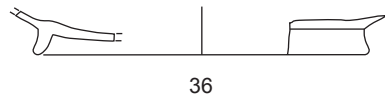

UE.7357

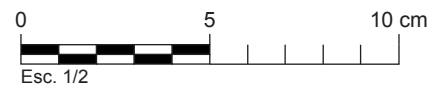
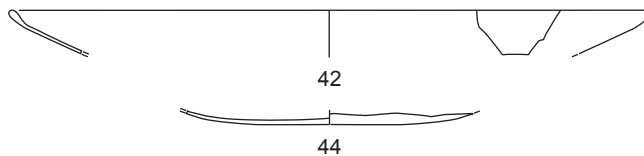

UE.7361

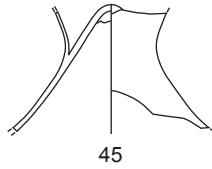

45

UE.7367



46

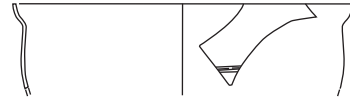

50

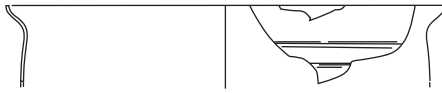

47



51

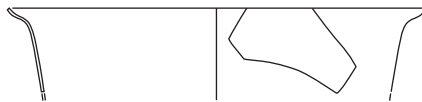

48



52

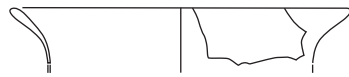

49



53



54

UE.7376

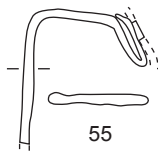

55

UE.7398

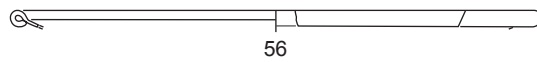

56



57

UE.7401



58

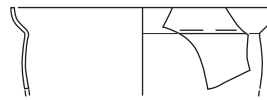

59

UE.7410



60



62



63



64

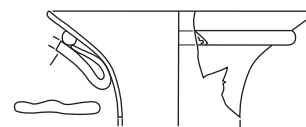

61



UE.7427



65

UE.7477

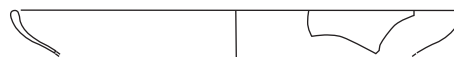

66



67



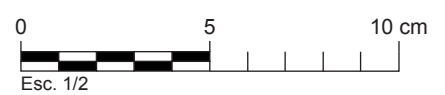
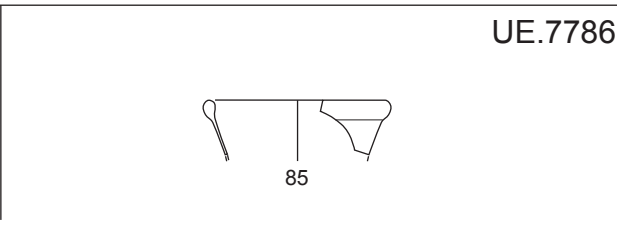
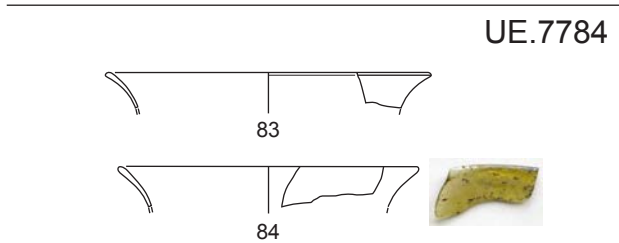
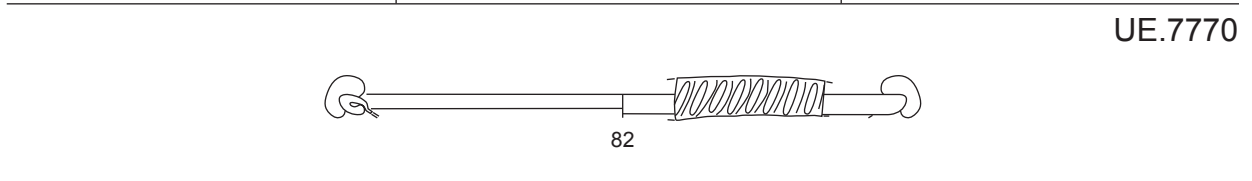
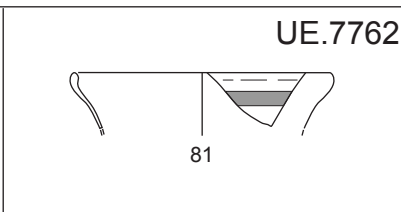
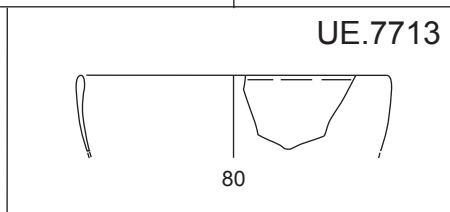
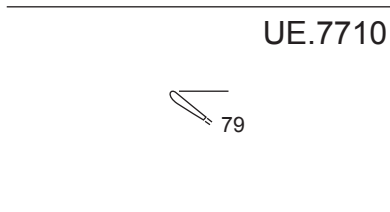
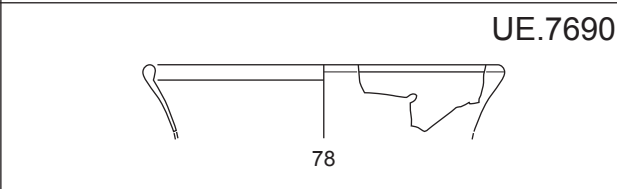
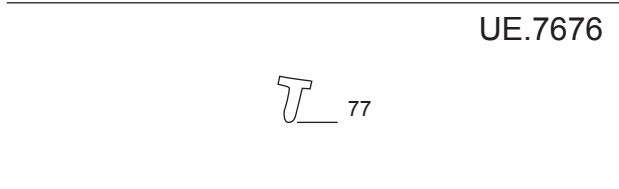
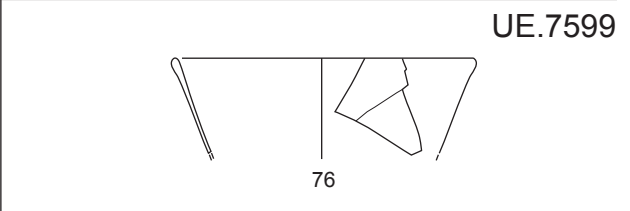
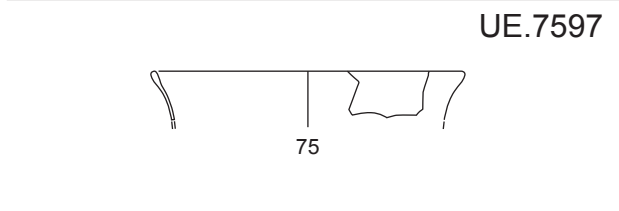
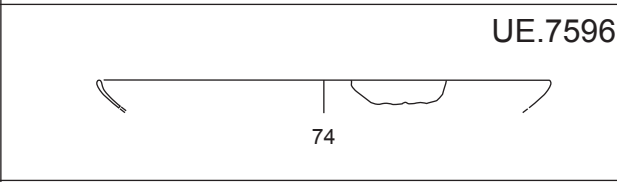
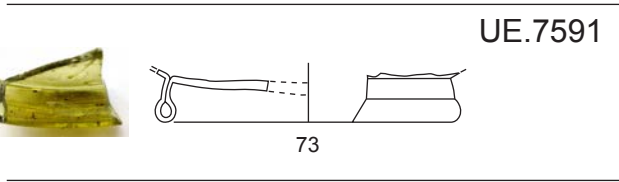
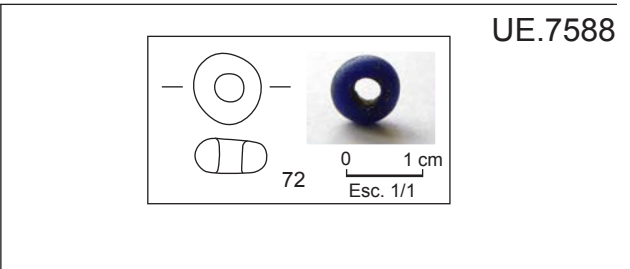
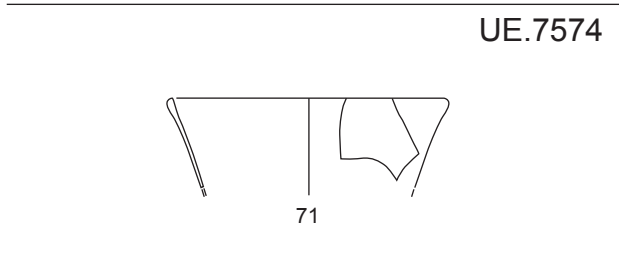
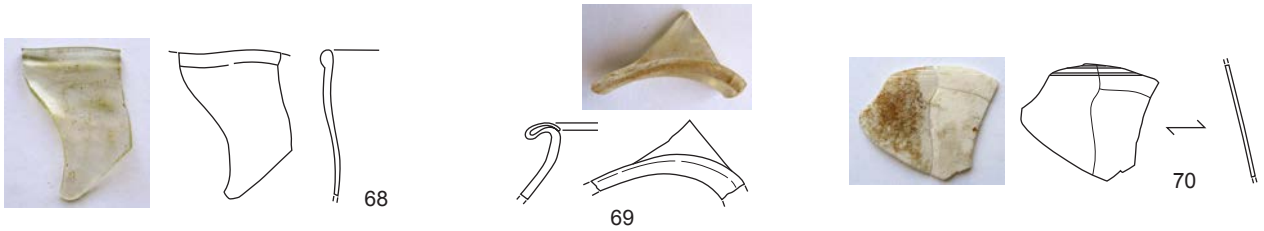

UE.7793

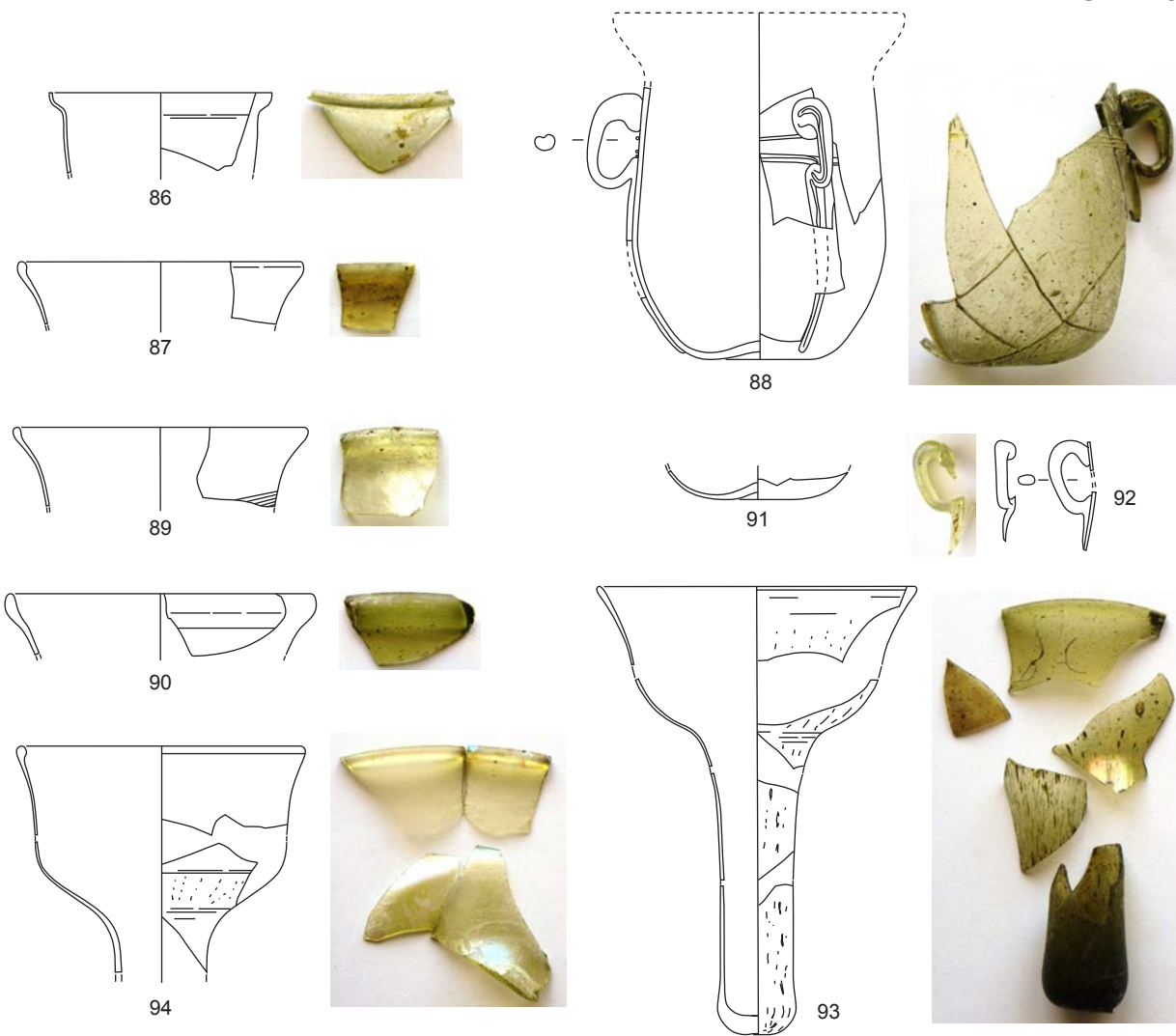

UE.7809

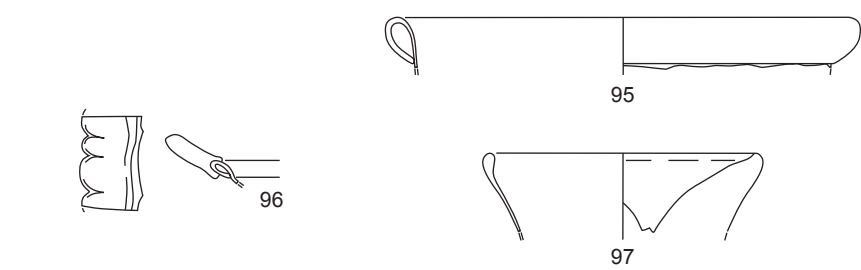

UE.7817

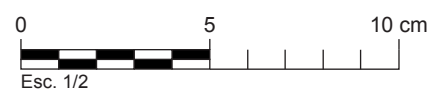
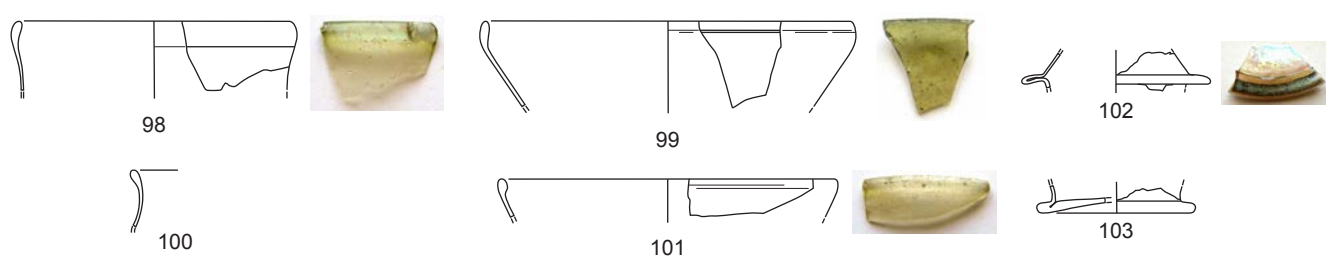

UE.7821

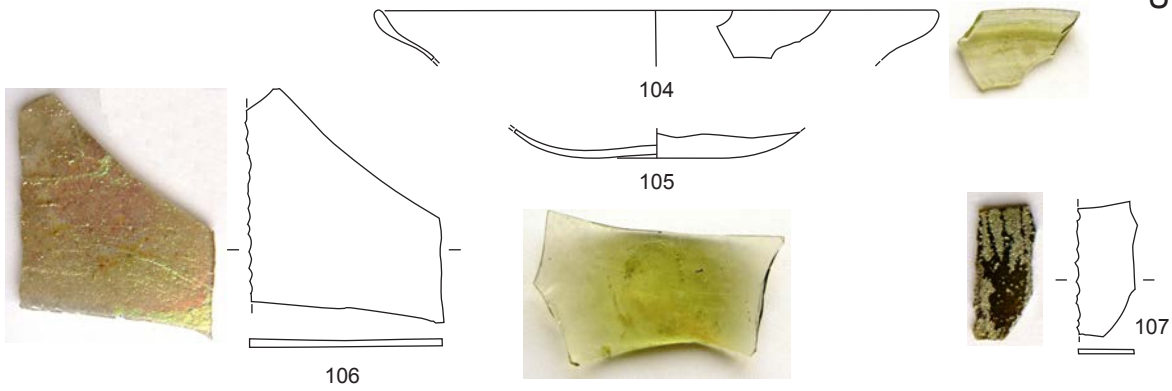

UE.7829

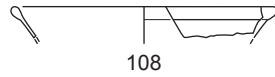

UE.7842

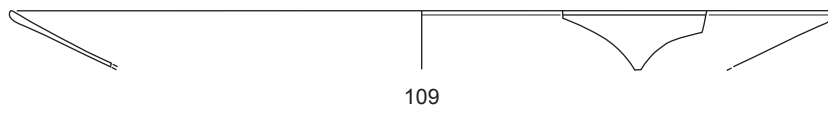

UE.7866

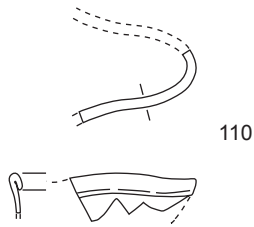

UE.7867

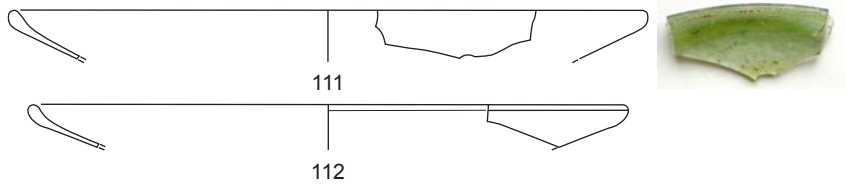

UE.7932



UE.7953

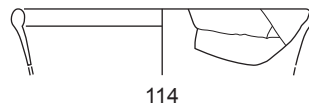

UE.7998

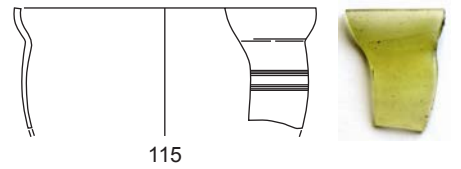

UE.71008



UE.71019





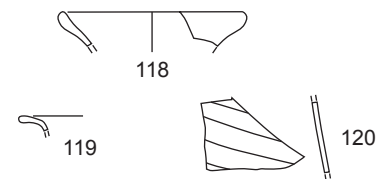



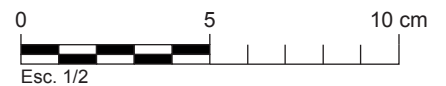
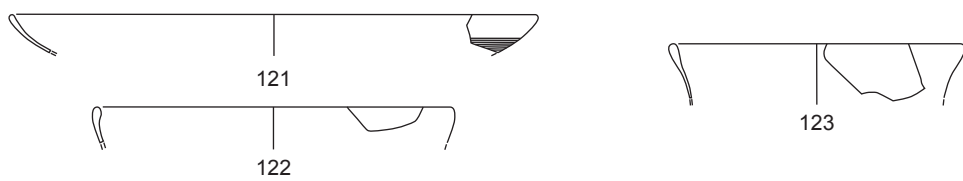

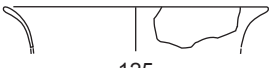

UE.71033

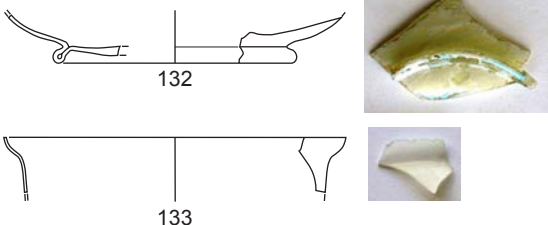

UE.71087

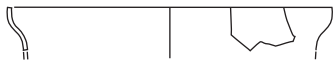

<p>UE.71126</p>  <p>124</p>	<p>UE.71129</p>  <p>125</p>	<p>UE.71173</p>  <p>126</p>
<p>UE.71183</p>  <p>127</p>	<p>UE.71188</p>  <p>128</p>	<p>UE.71198</p>  <p>129 130</p>
<p>UE.71208</p>  <p>131</p>	<p>UE.71259</p>  <p>132 133</p>	<p>UE.71268</p>  <p>134</p>
<p>UE.71286</p>  <p>135</p>	<p>UE.71297</p>  <p>136 137</p>	
<p>UE.71309</p>  <p>138</p>		

UE.71311

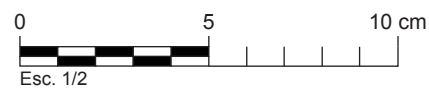
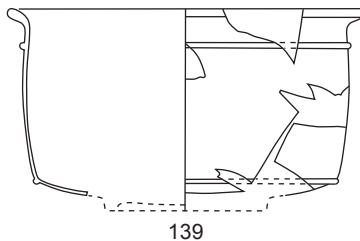

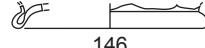
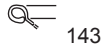
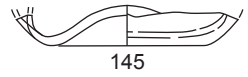

141

142

143

144

145

147

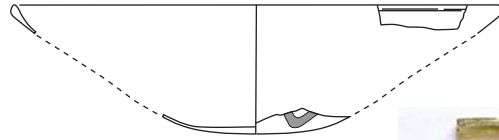
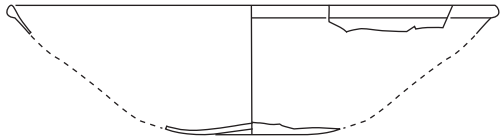

148

149

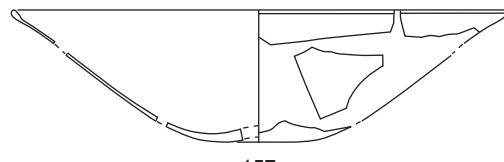
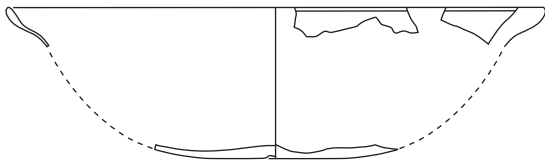
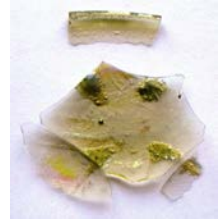
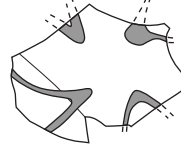

150

157

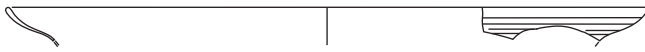

151



158



152



159



153



160

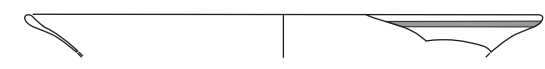

154

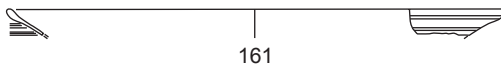

161



155



162

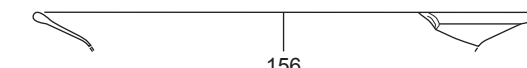

156

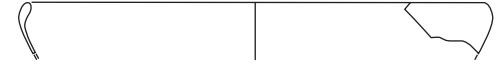

163

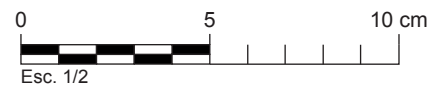

Esc. 1/2

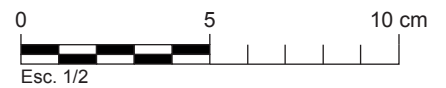
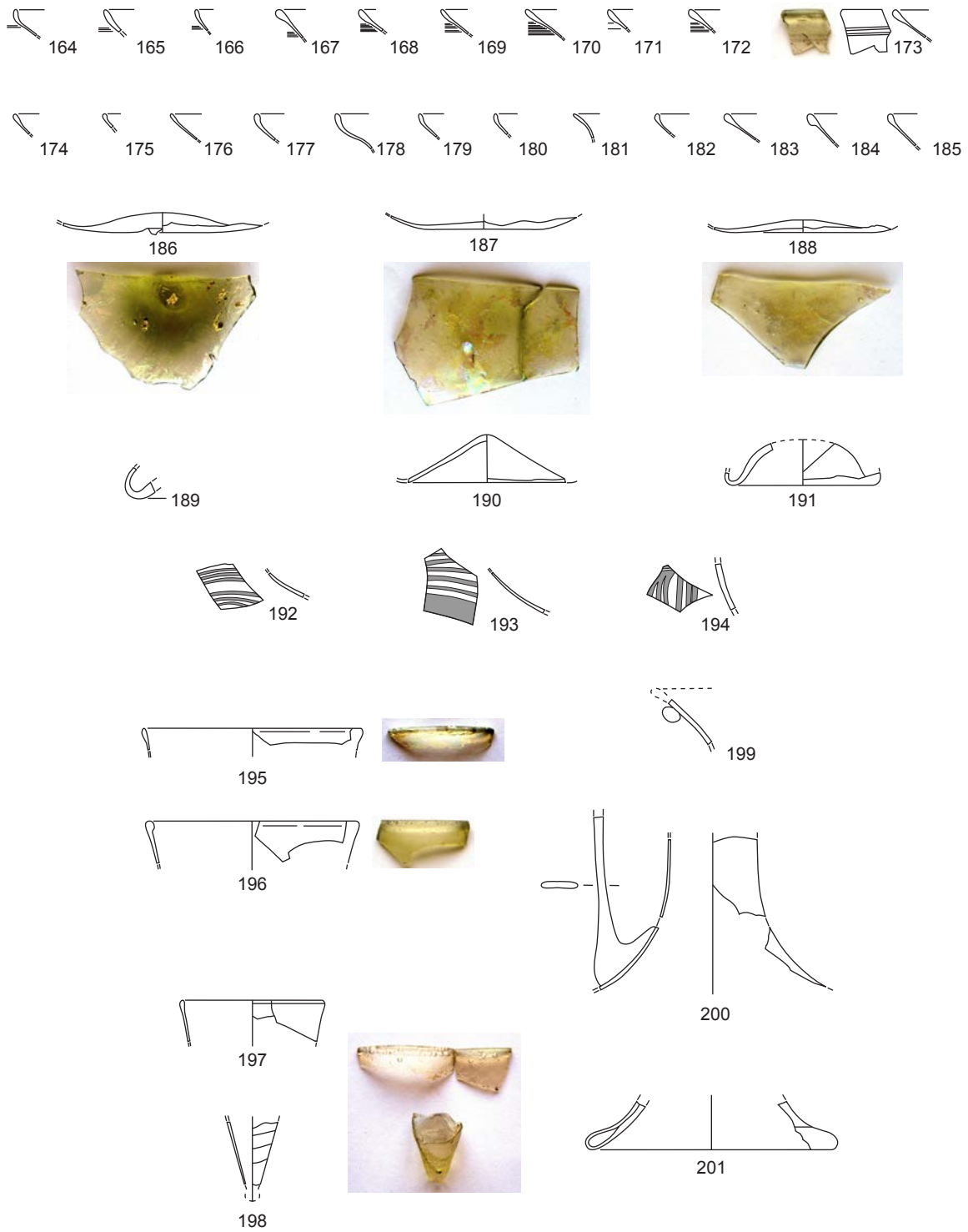



UE.71344

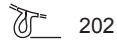

UE.71347

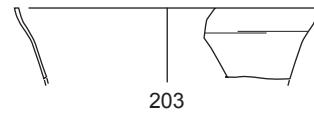

UE.71348



UE.71361

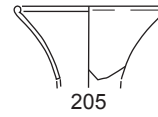

UE.71402

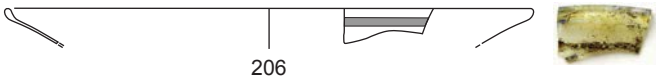

UE.71405



UE.71404

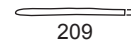
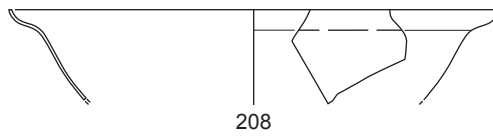

UE.71430

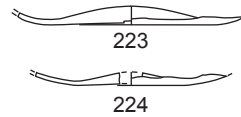
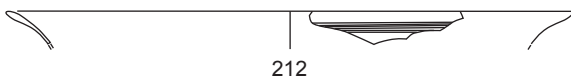
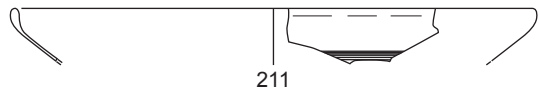
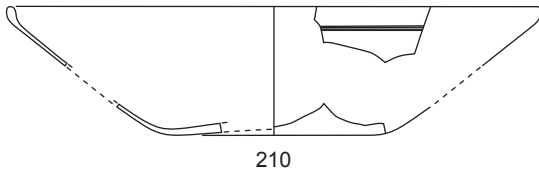

UE.71431



UE.71433



UE.71435



UE.71437



UE.71455



UE.71475

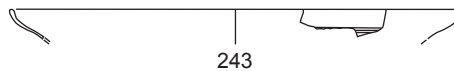

UE.71509



UE.71521

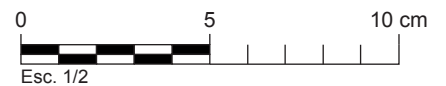

UE.71540

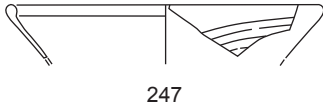

247

UE.71543

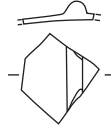

248

UE.71544

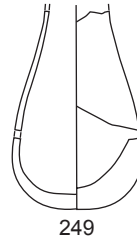

249

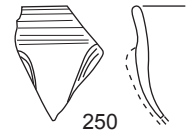

250

UE.71546

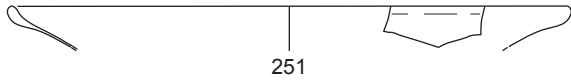

251



258

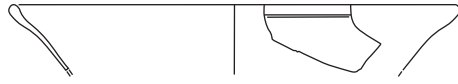

252

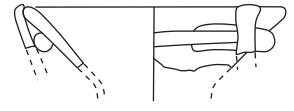

259

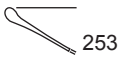

253

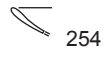

254

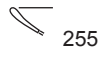

255



256



257

UE.71555

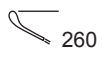

260

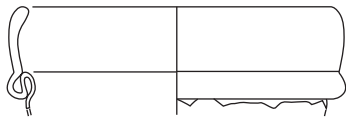

261



262

UE.71556

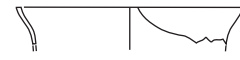

263

UE.71564



264

UE.71569



265

UE.71571

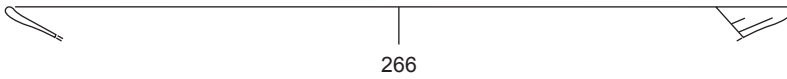

266



267

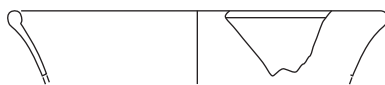

268

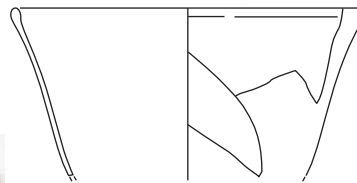

276

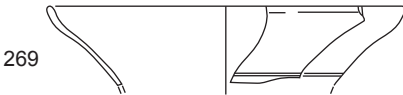

272



273



274



277



271

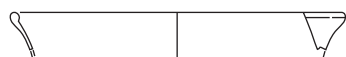

275

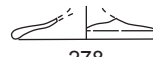

278

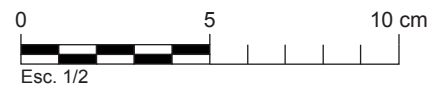

UE.8042

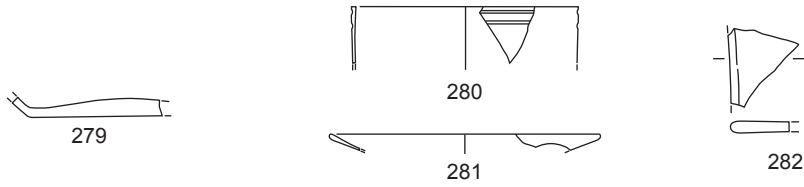

UE.8055



UE.8074

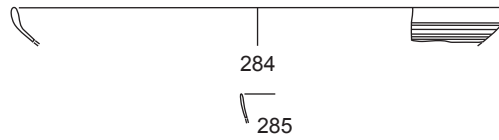

UE.8088

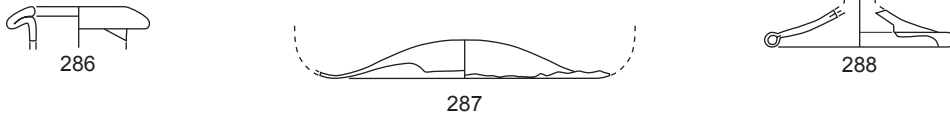

UE.8113

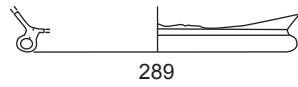

UE.8136

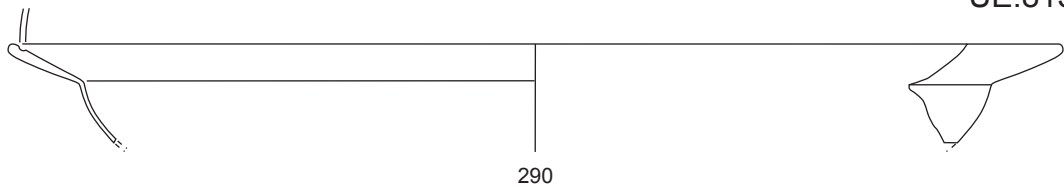

UE.8154

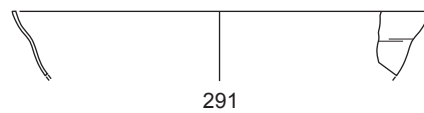

UE.8244

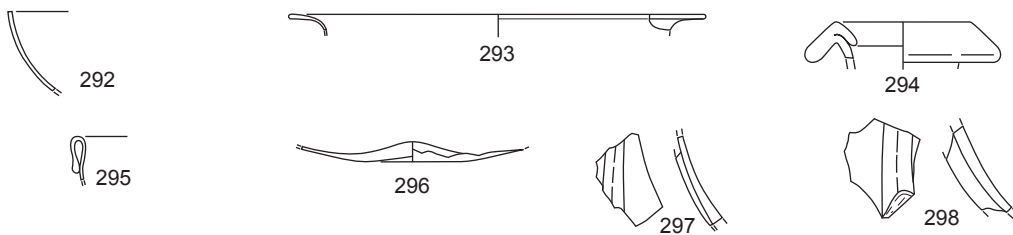

UE.8252

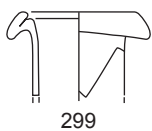

UE.8286

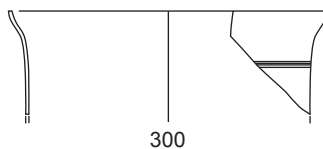

UE.8299

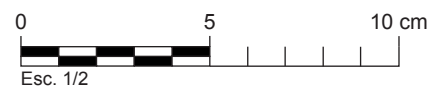
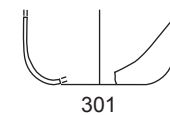

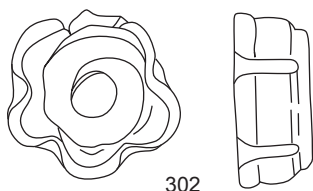

302

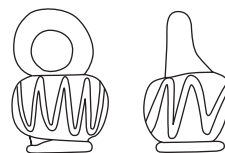

318

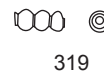

319

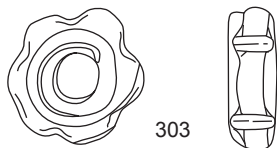

303

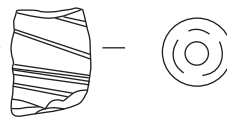

320



321



304



322



323

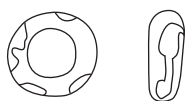

305



321

323



322

319



306



311

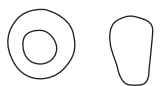

307



312

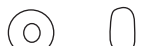

308



313



309



314

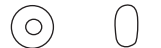

310



315



316



317

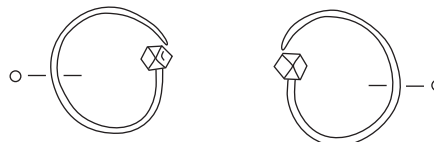

arracades d'argent

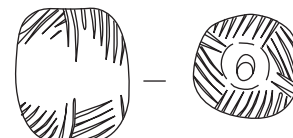

penjoll d'atzabeja



306

307

308

309

310

311

312

313

314

315

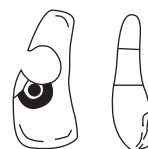

penjoll de dent d'ós



dentalium

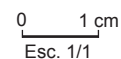

Esc. 1/1

UE.8344



324

UE.8357



325

UE.8371



326

UE.8372



327



328

UE.8380



330



329



331



335

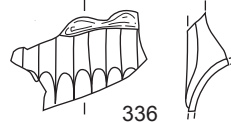

336

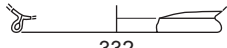

332



333



334



337



329

336

331

333

332

330

335

337

UE.8392

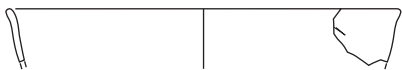

338

UE.8404



339

UE.8414

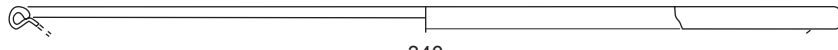

340



341

UE.8504



342



343

UE.8537



344

UE.8558

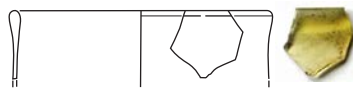

345

UE.8562

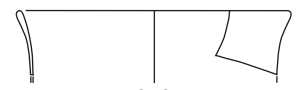

346



347

UE.8572



348



349

UE.8591



350



351

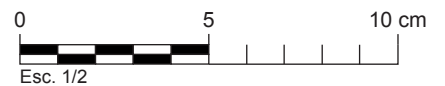

UE.8631

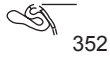

352

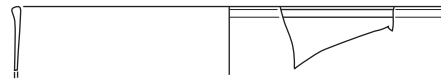

353

UE.8664

UE.8669



354

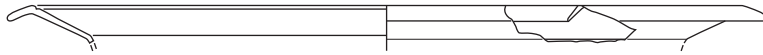

355

UE.8682



356



357



358

UE.8686

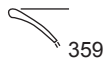

359



360



363



361



362



364

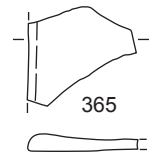

365

UE.8689



366



367

UE.8713



368

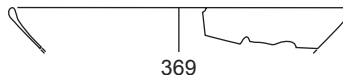

369

UE.8716



370

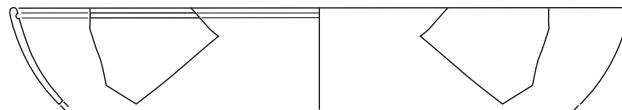

372



371

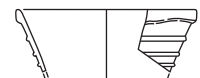

373



374



375



376

UE.8721

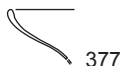

377



378

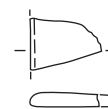

379

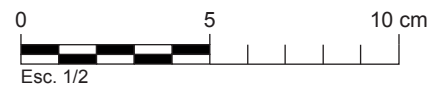

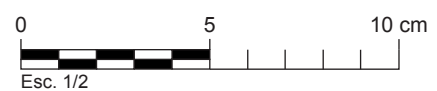
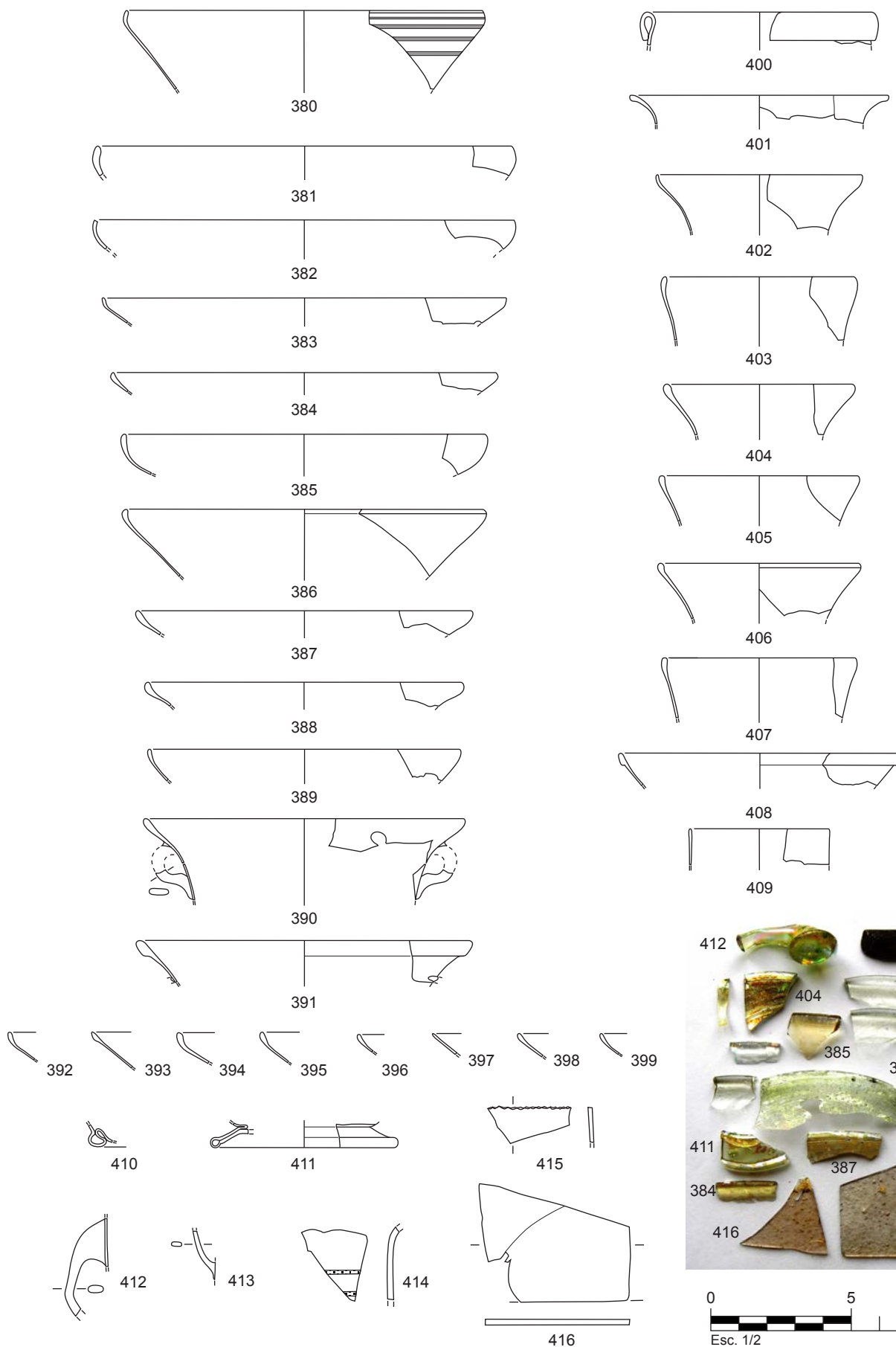

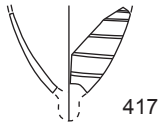

UE.8729



UE.8730

UE.8731



419



420

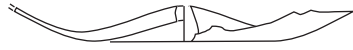

421

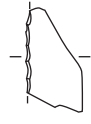

422

UE.8732



423

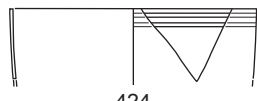

424



425

UE.8733



426

UE.8737



427

UE.8738



431

435

435

430

434

429

432

432

432

432

432

432

432

432

432

432

432

432

432

432

432

432

432



428



429

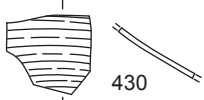

430



432

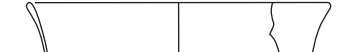

433

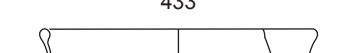

434

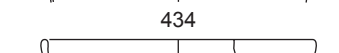

435



435



431

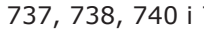
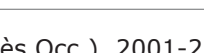
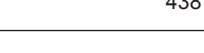

436

Rebuigs de taller

UE.8740



437

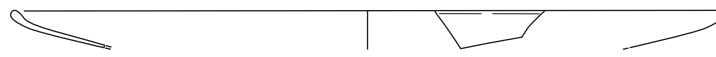

438

UE.8741



439



440



441

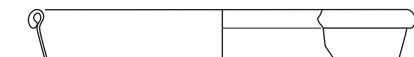

442

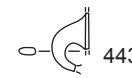

443

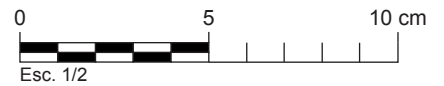



UE.8742

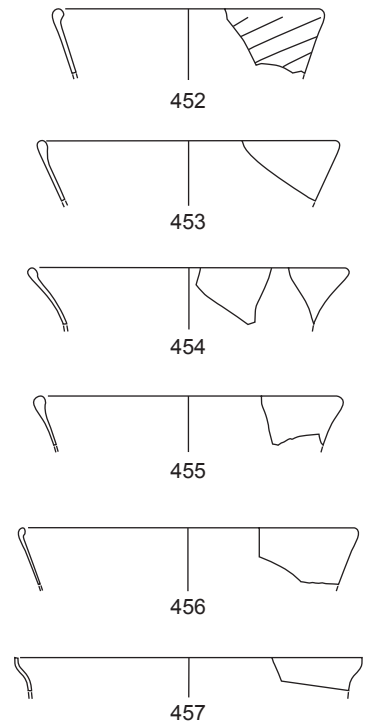
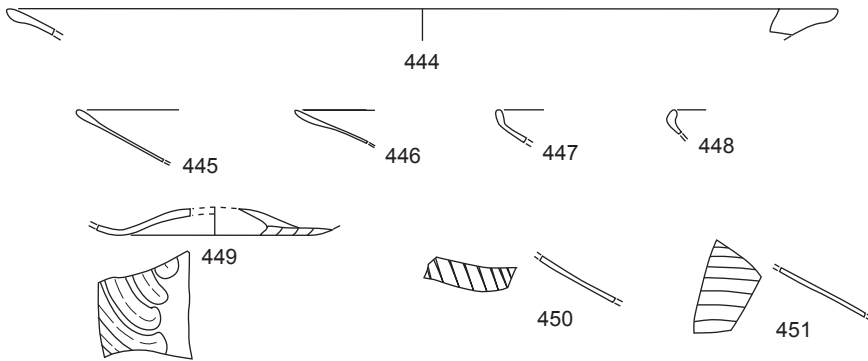

Rebuijs de taller

UE.8756

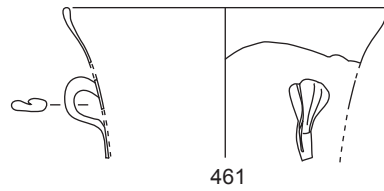
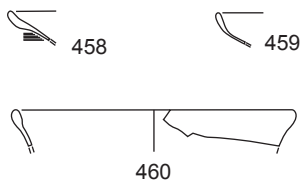

UE.8760



UE.8767

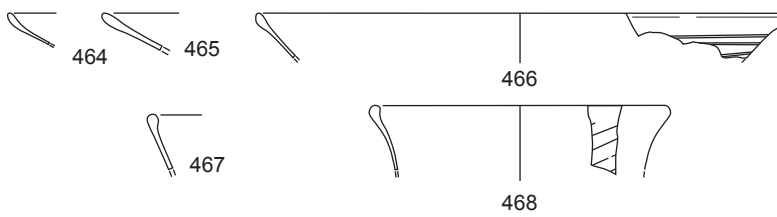

UE.8783

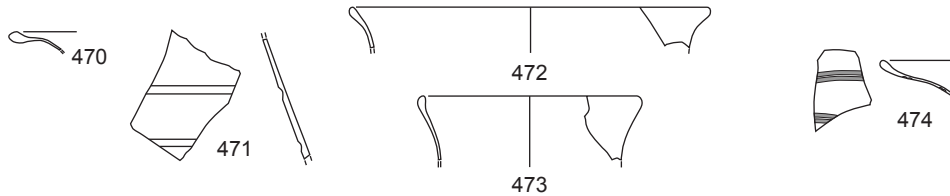

UE.8788

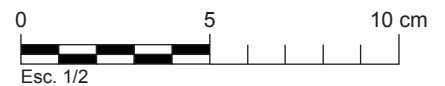
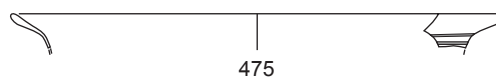

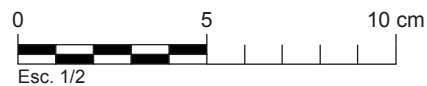
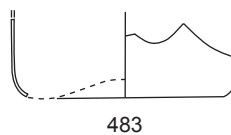
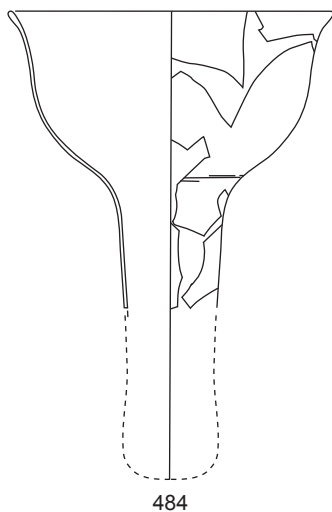
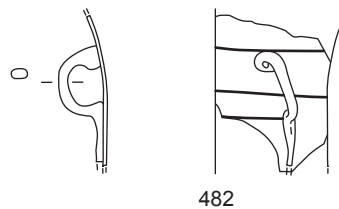
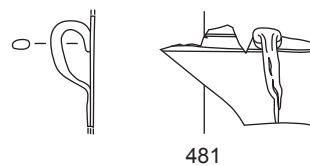
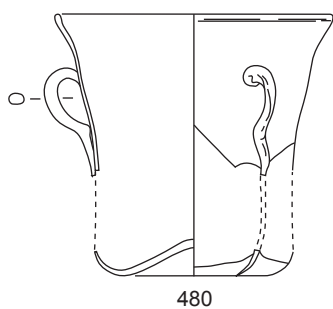
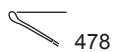
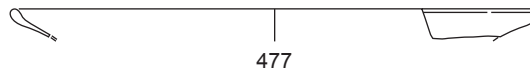

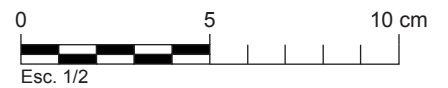
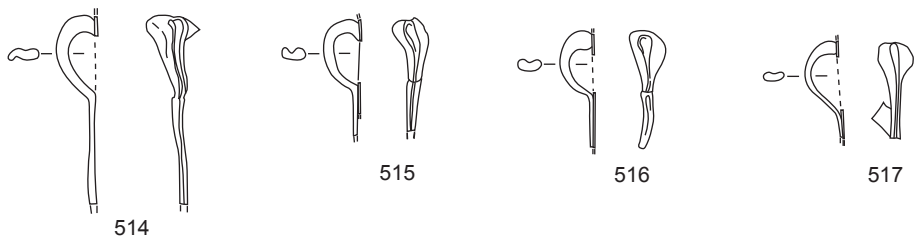
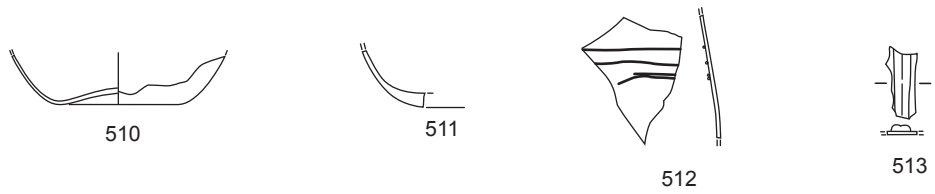
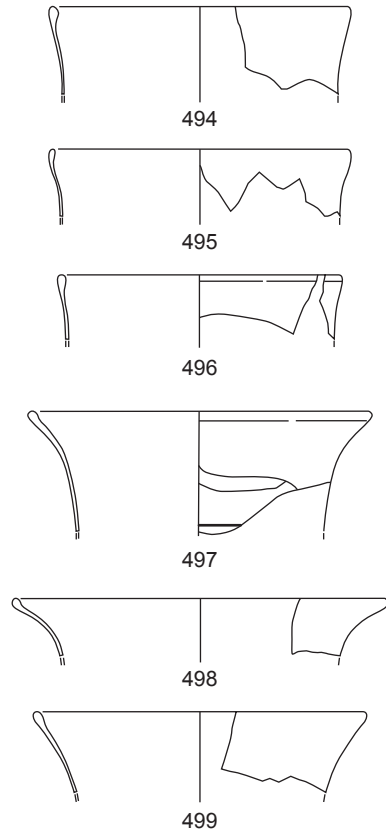
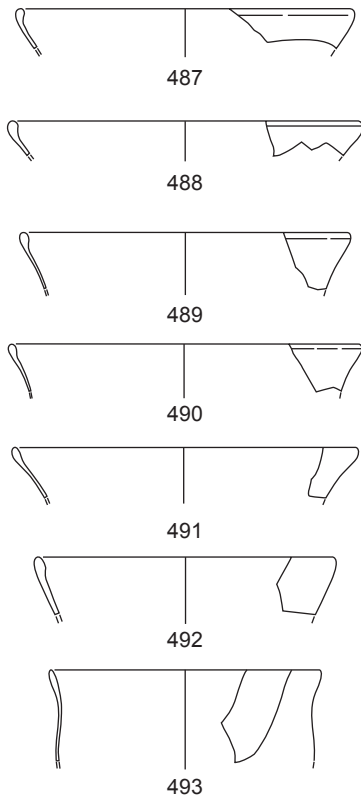

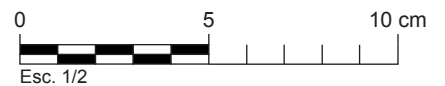
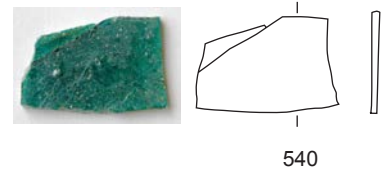
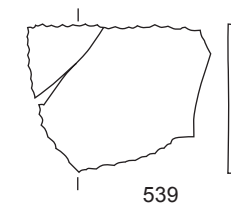
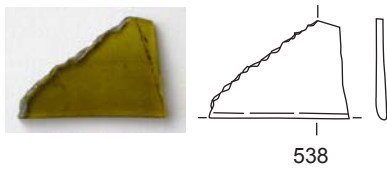
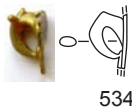
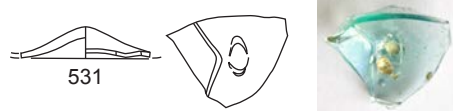
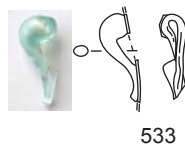
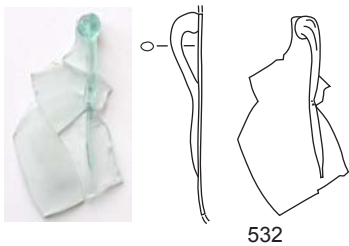
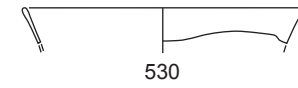
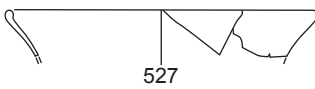
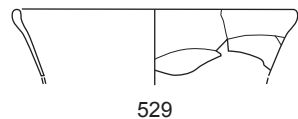
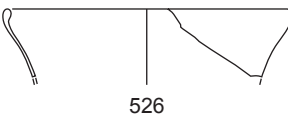
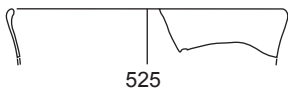
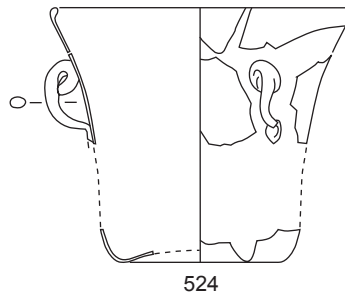
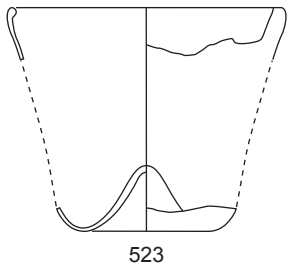
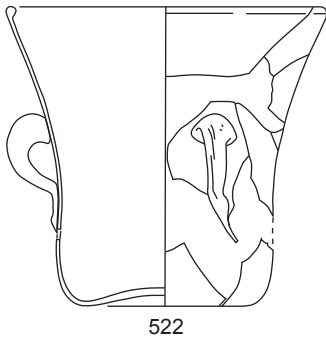

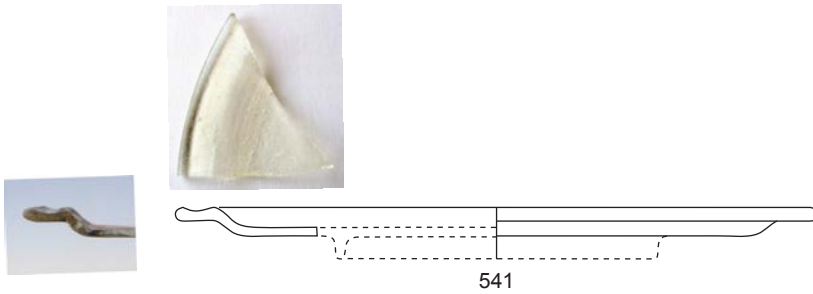

541

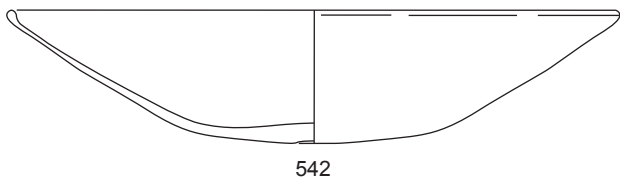

542

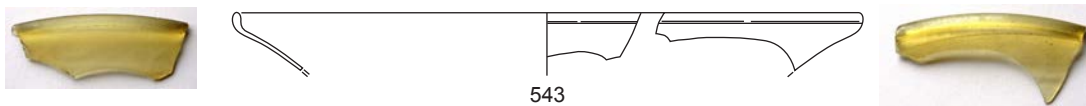

543



544

545

547

546



548

549

550

551



552

553

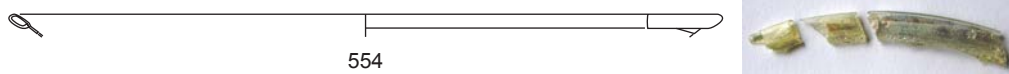

554

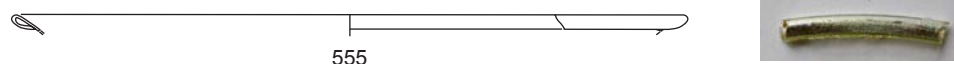

555

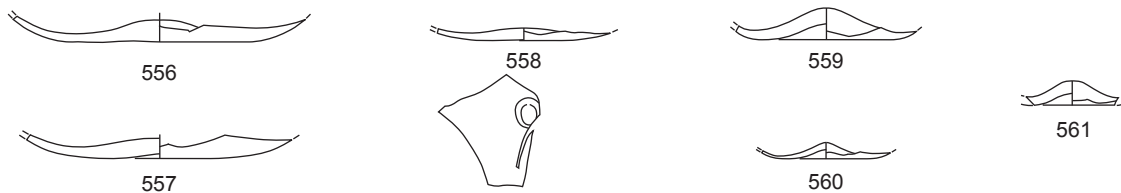

556

558

559

561

557

560

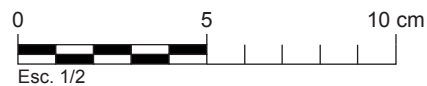

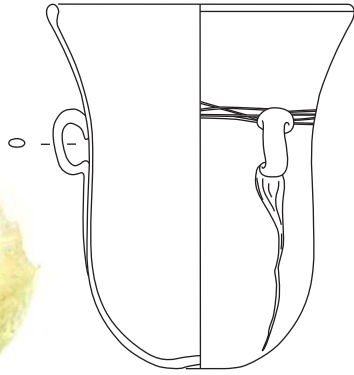
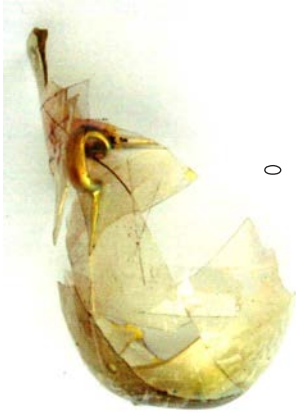

562

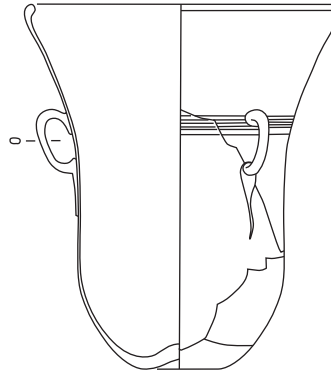

567

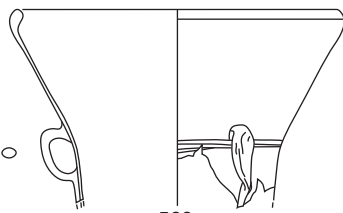

563

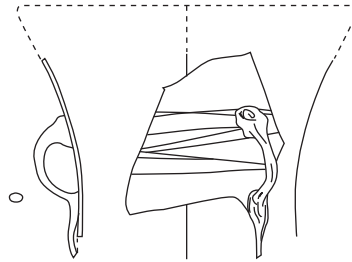

568

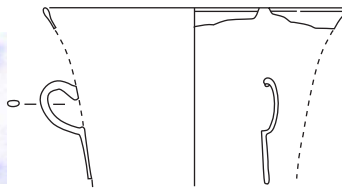
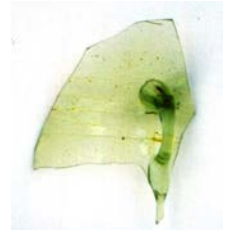

564

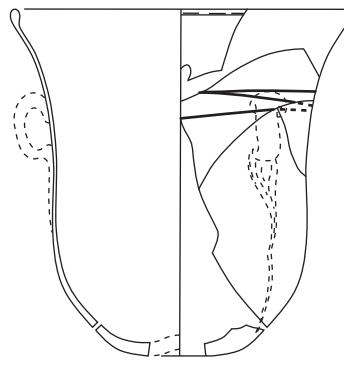

569

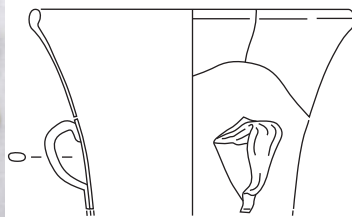

565

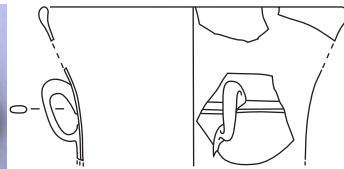

566



570



571

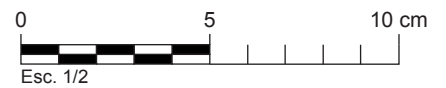

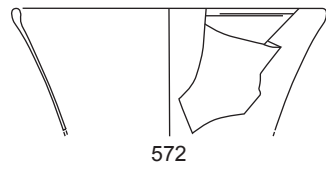

572

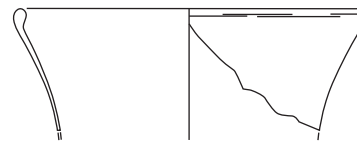

579

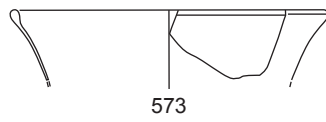

573

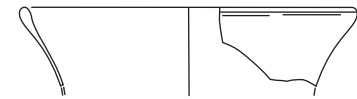

580



574

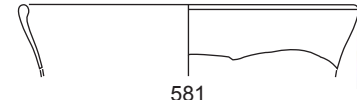

581

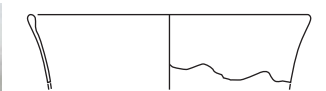

575

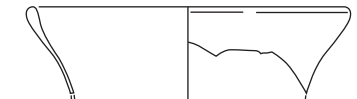

582



576



583

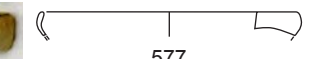
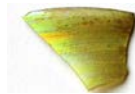

577



584



578

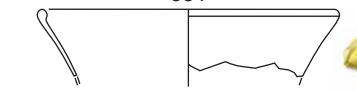

585



586



587



588



589



590



591



592



593



594



595



596



597



598



599



600

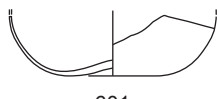
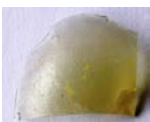

601

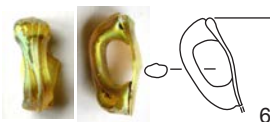

605

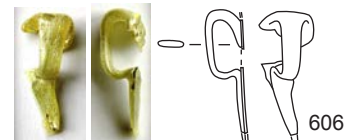

606



602

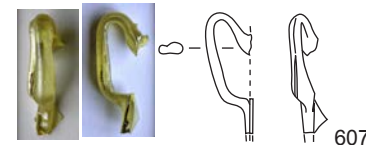

607



608

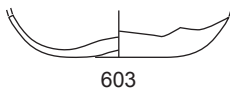

603

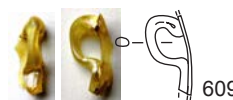

609



610

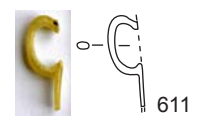

611

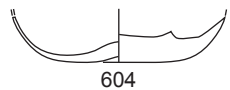

604

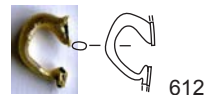

612



613

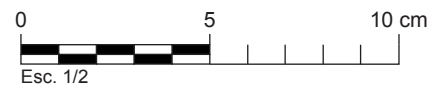

UE.8814

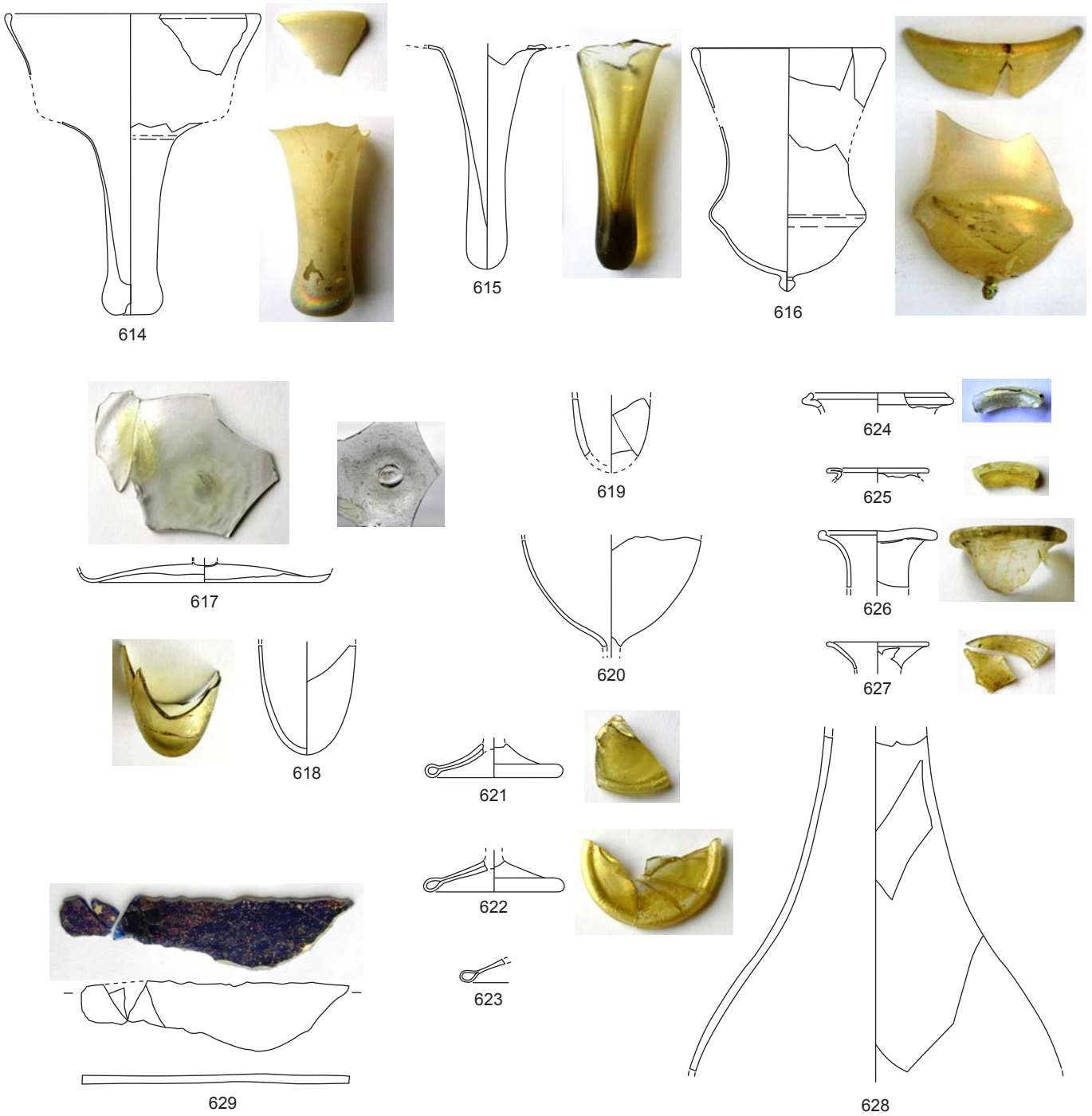

UE.8815

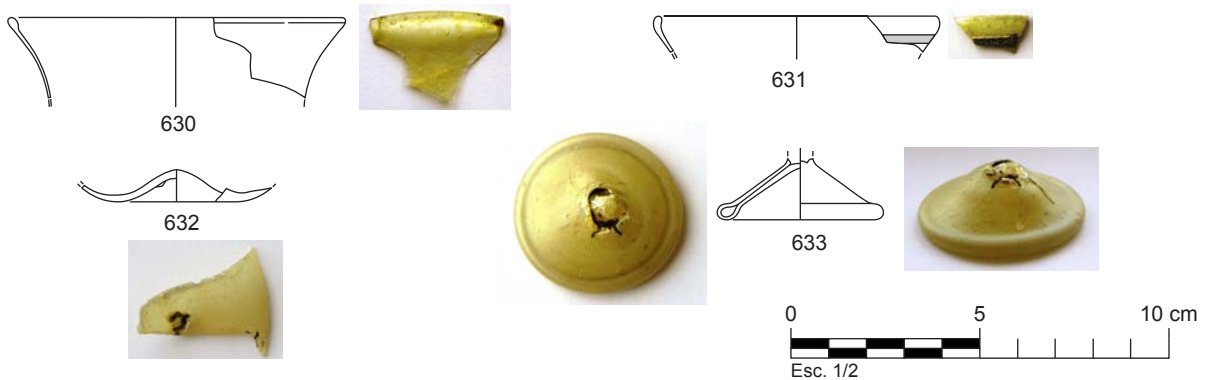



UE.8810



634

UE.8818



635

UE.8820



636



637

UE.8847

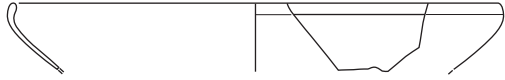

638

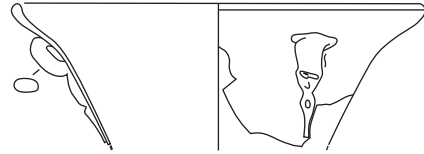

649



639

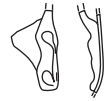

650



640

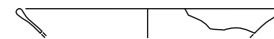

651



641

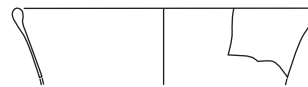

652



642



643



644



645



646

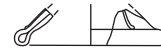

653



647



648

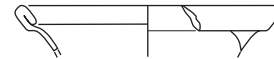

654



655

UE.8871



656



657

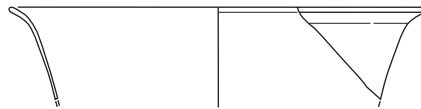

661



667



658



662



668



659



663



669

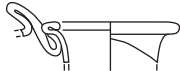

660



664



665



666



670



671



672

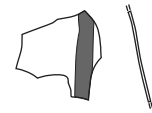

673

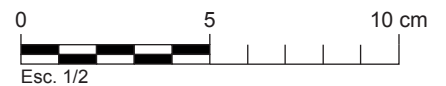

UE.8872

674

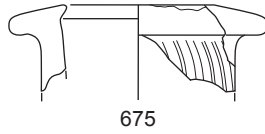

675

UE.8880



676

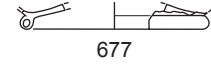

677

UE.8892



678

UE.8961

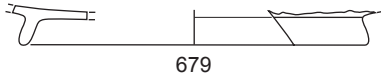

679



680

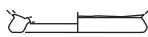

681

UE.8962



682



683

UE.81011



684

UE.81033



685



686

UE.81040

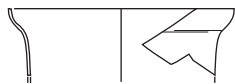

687

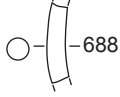

688

UE.81074



689

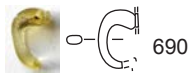

690

UE.81078

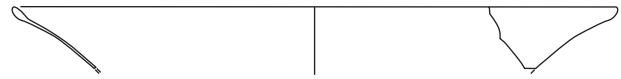

691

UE.81079



692

UE.81093

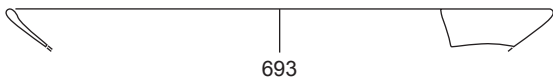

693



694

UE.81097

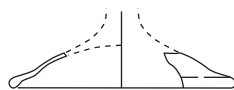

695

UE.81119



696



697

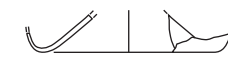

698

UE.81120



699

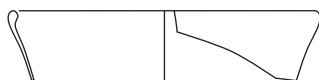

700



701

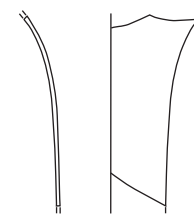

702

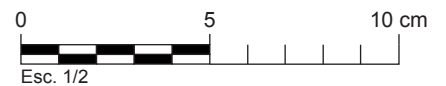

Esc. 1/2

UE.81121

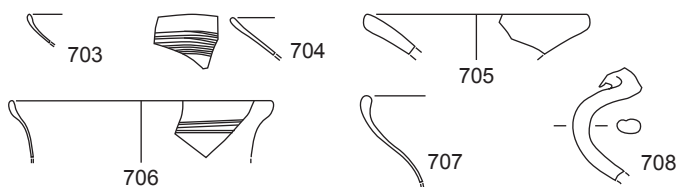

UE.81128



UE.81129

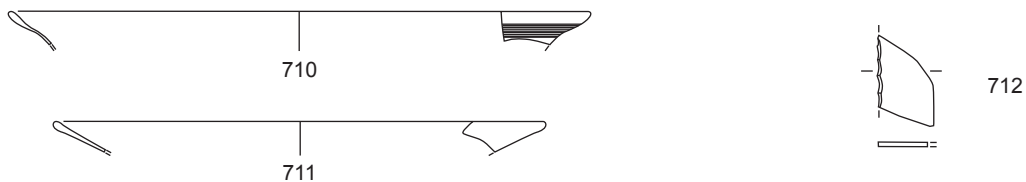

UE.81150

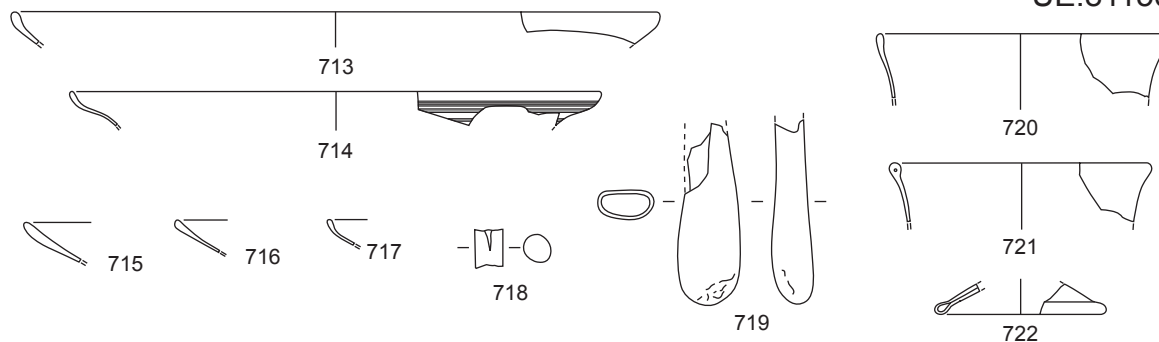

UE.81162

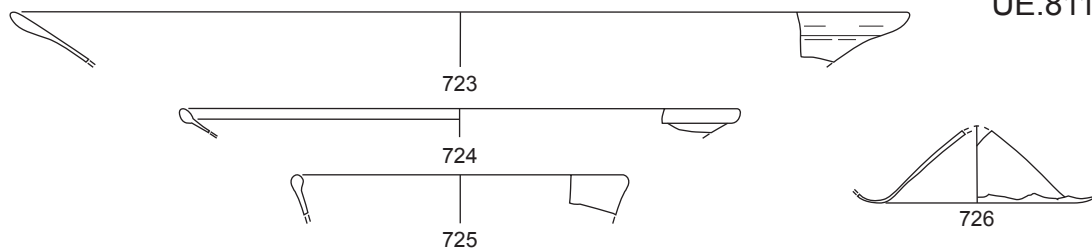

UE.81165

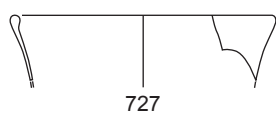

UE.81172

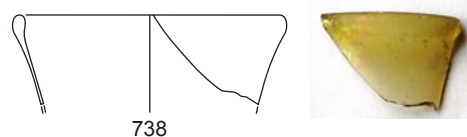

UE.81176

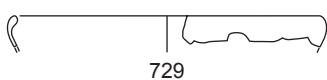

UE.81180

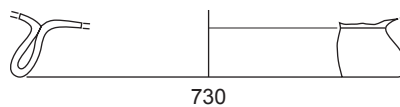

UE.81373

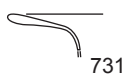

UE.81515

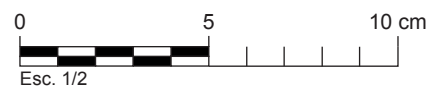
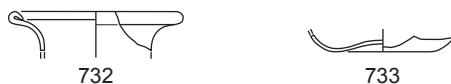



734



735



736



740



742

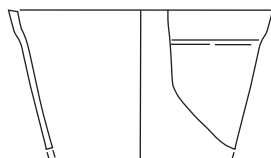

738



739

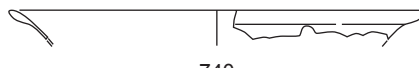

741

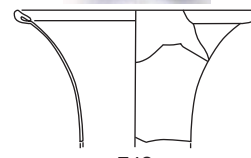

743



739



741

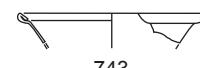

744



745



746



747



748



749



750



751



745

749

748



752



755



746

747

747



753



756



754

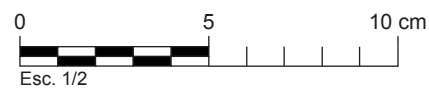

Esc. 1/2

UE.10003



757

UE.10024

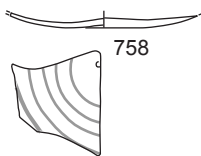

758

UE.10027



759

UE.10030

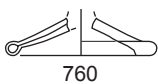

760

UE.10048

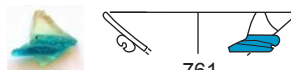

761

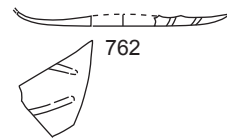

762

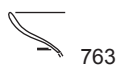

763

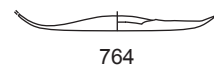

764

UE.10052

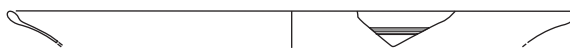

765

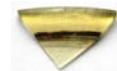

UE.10057



766

UE.10058

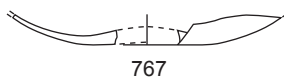

767



768

UE.10123

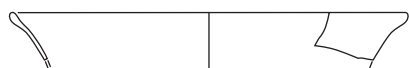

769



UE.10124

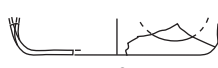

770



771

UE.10130

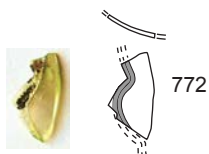

772

UE.10195



773

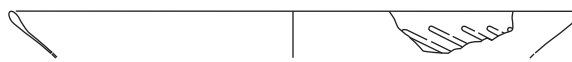

774

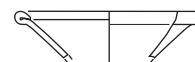

775

UE.10196



776

UE.10198

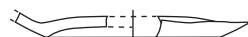

777

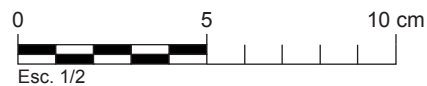

Esc. 1/2

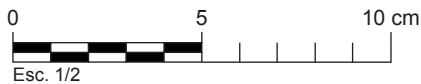
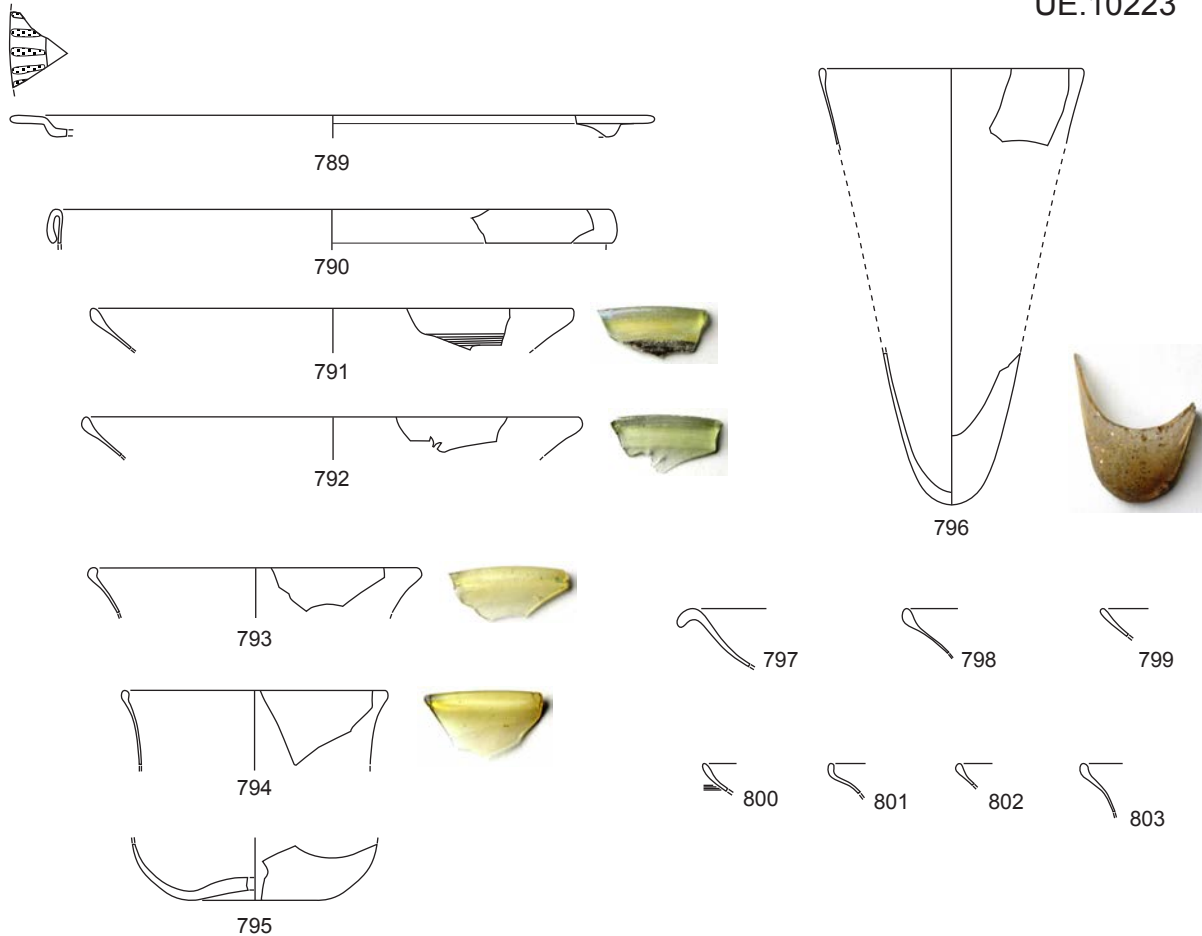
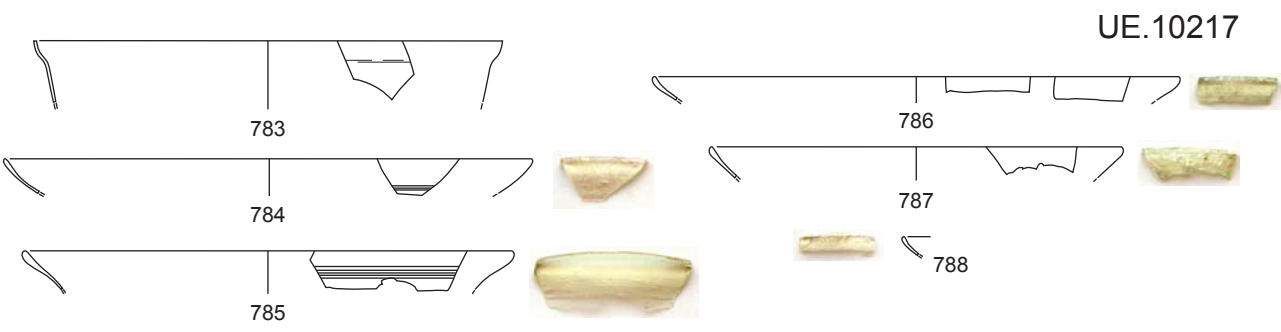
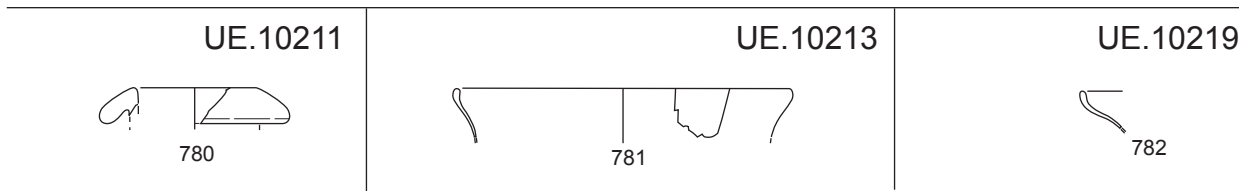
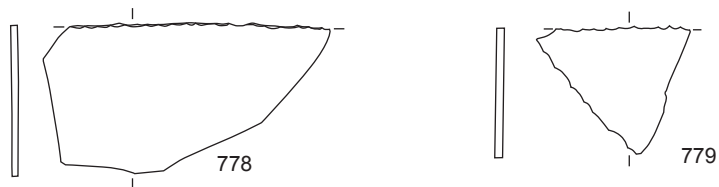

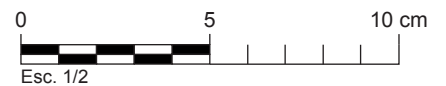
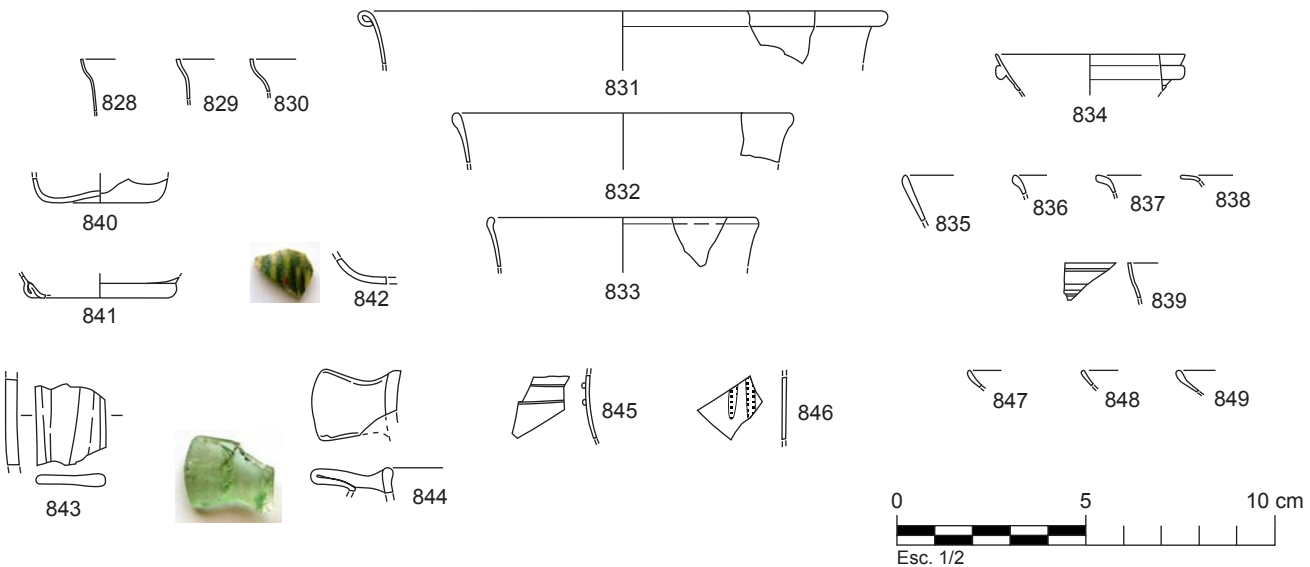
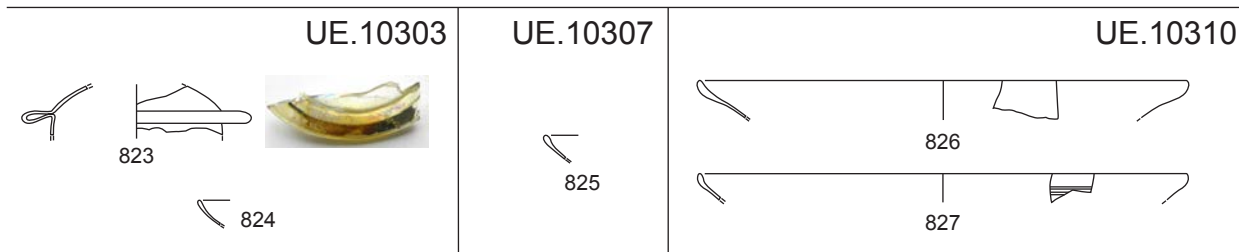
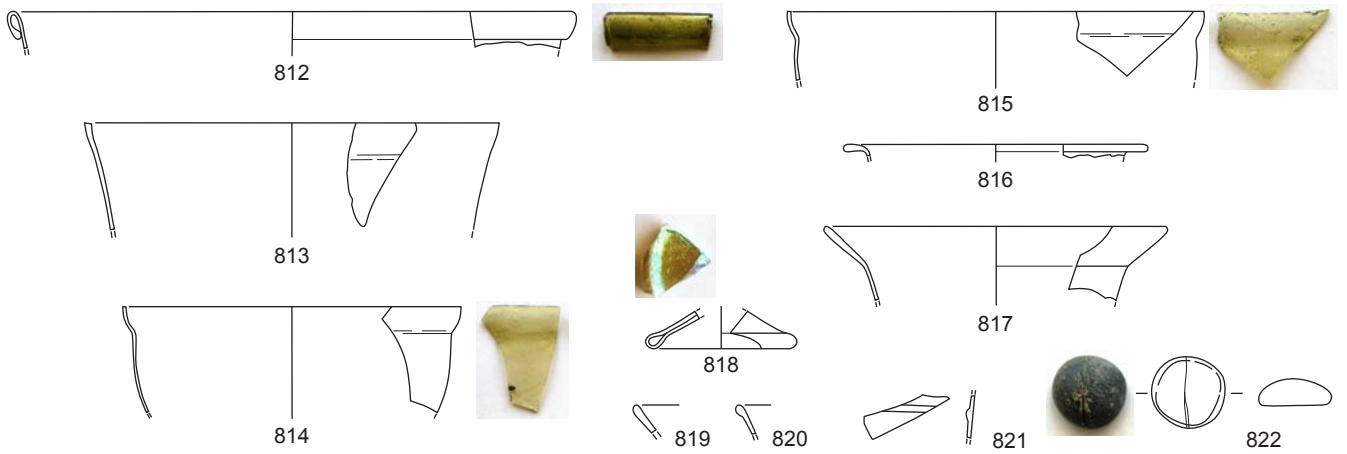
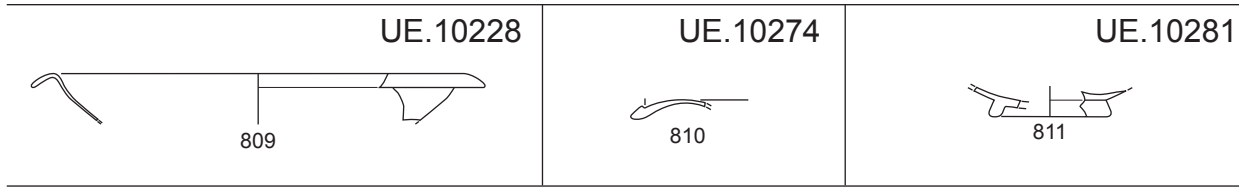
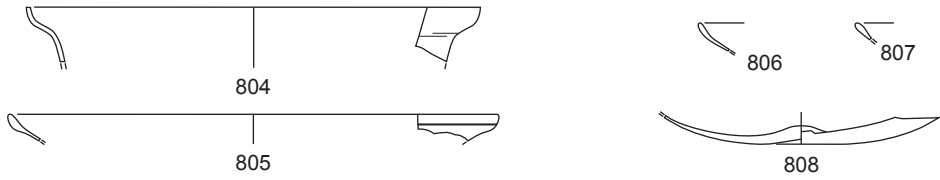

UE.10318

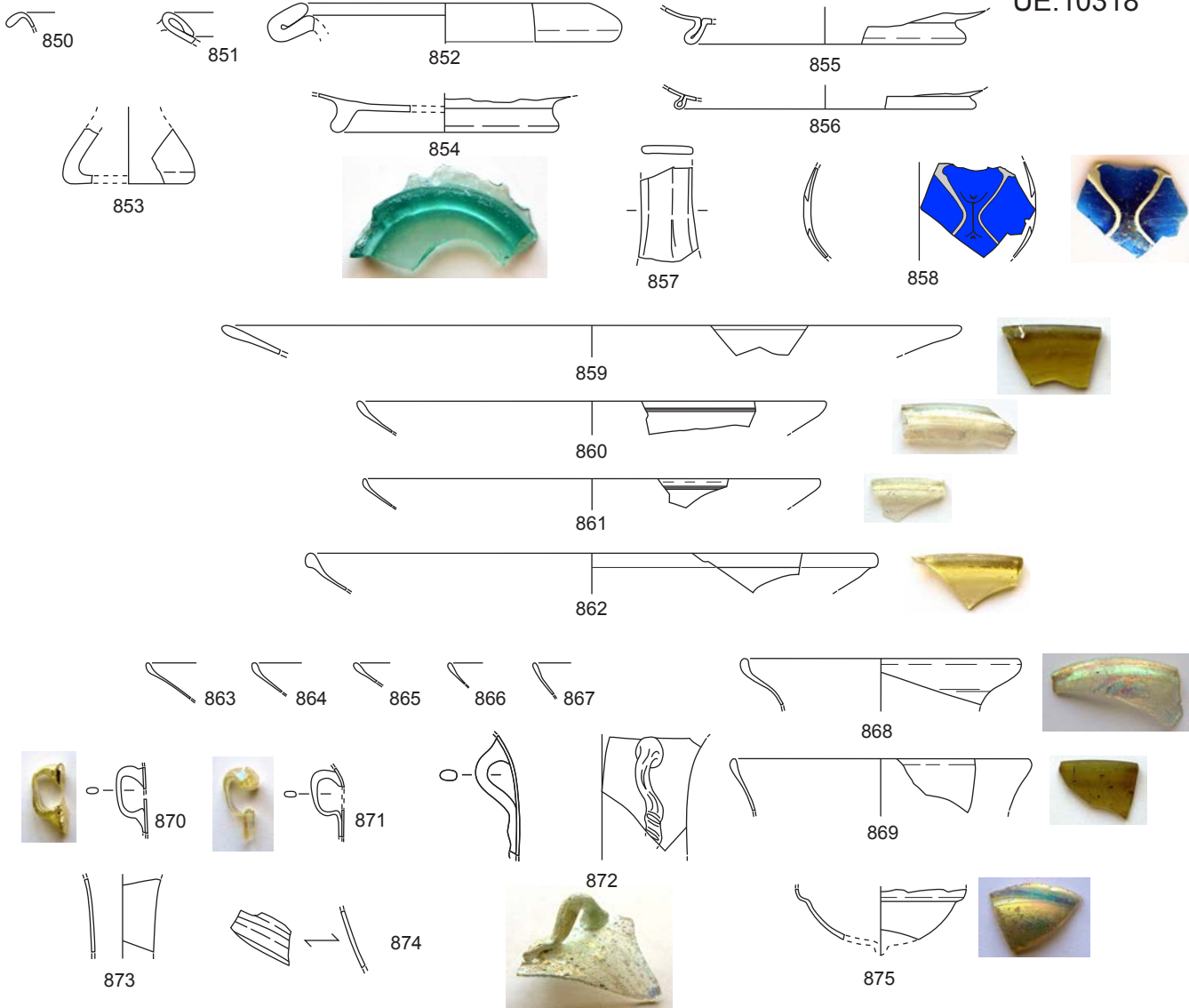

UE.10322

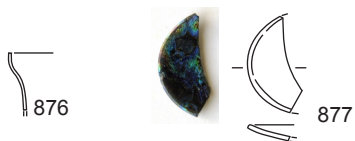

UE.10330



UE.10340

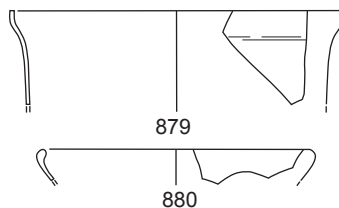

UE.10341

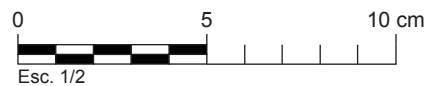
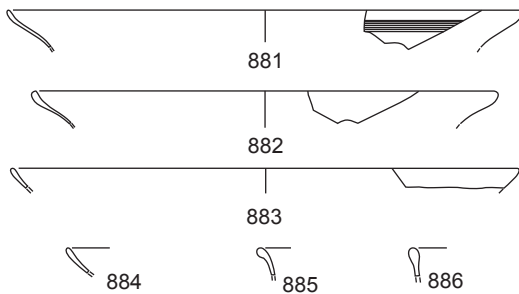



UE.10346

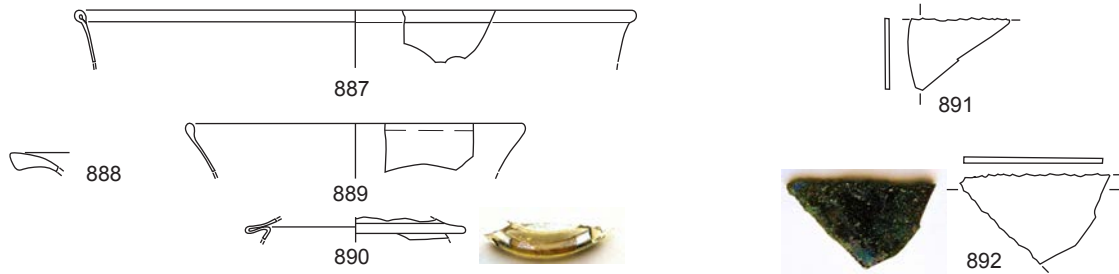

UE.10347

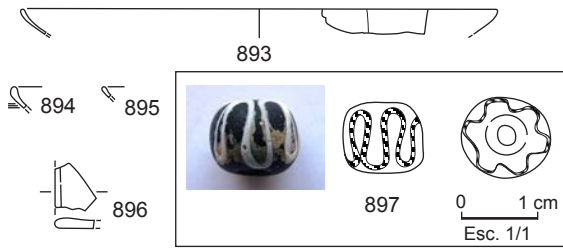

UE.10357

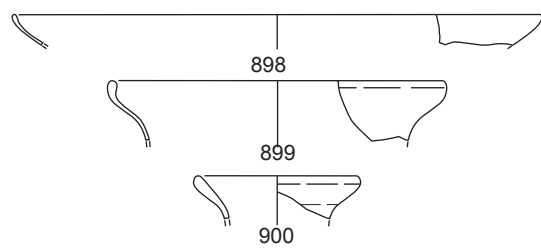

UE.10371

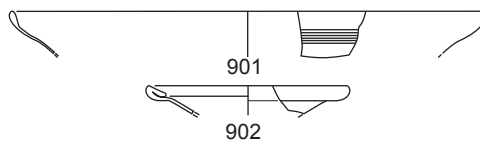

UE.10452

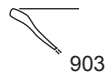

UE.10455

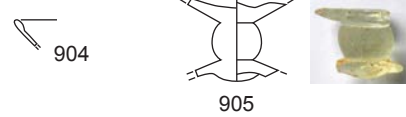

UE.10459

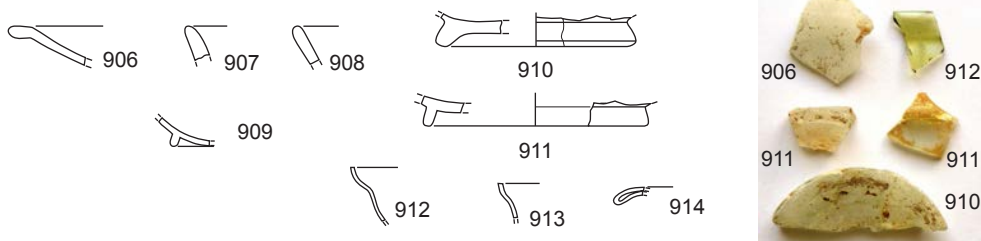

UE.10463

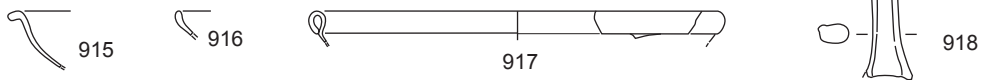

UE.10479

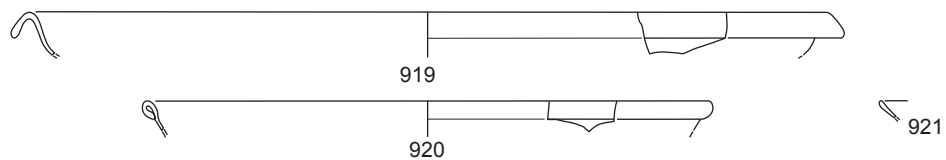

UE.10493

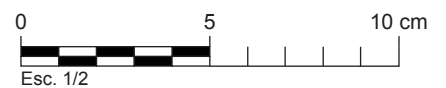

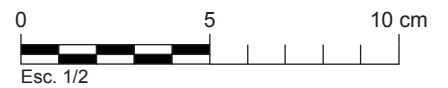
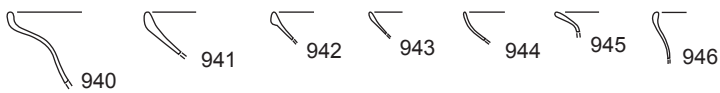
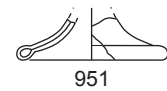
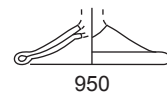
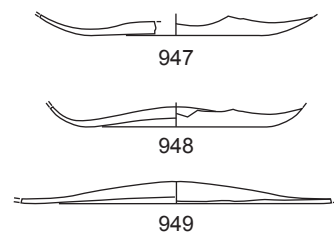
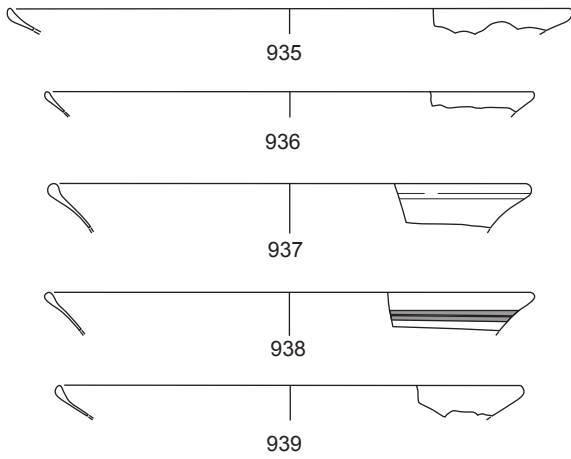
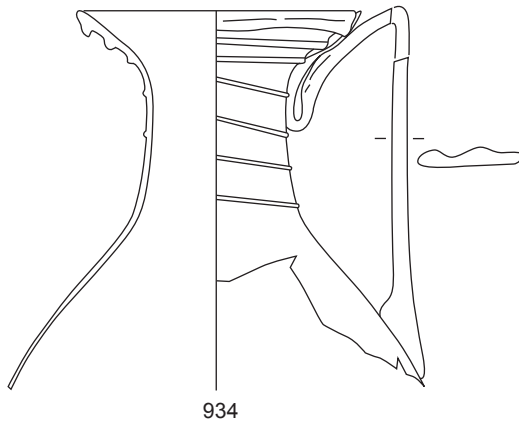
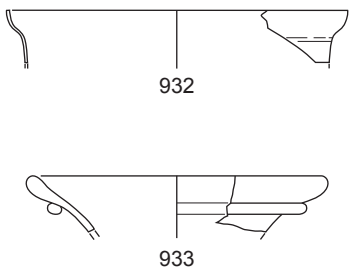
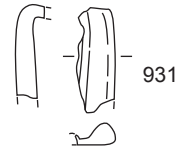
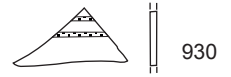
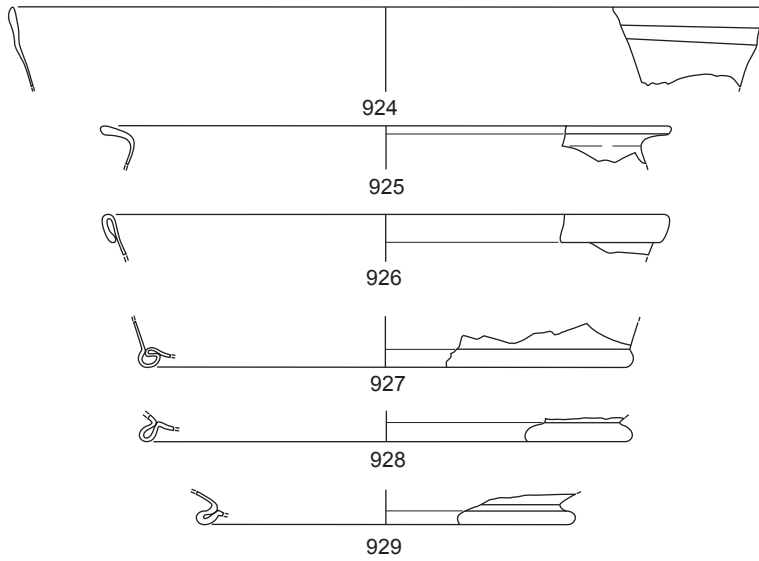

UE.10622

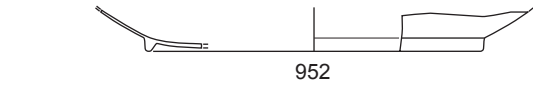

952

UE.10637



953

UE.10653

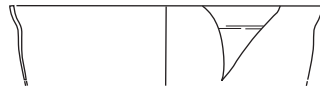

954



955

UE.10682

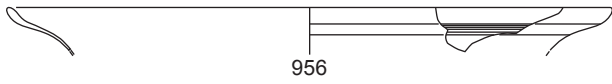

956



957

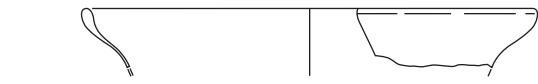

958

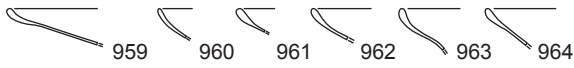

959

960

961

962

963

964



965

966

967

968

969

970

971



972



973



975

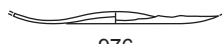

976



977



974

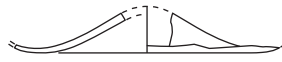

978



979

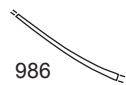

986



985

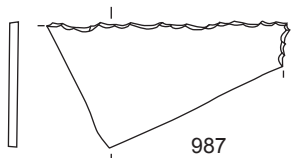

987



988

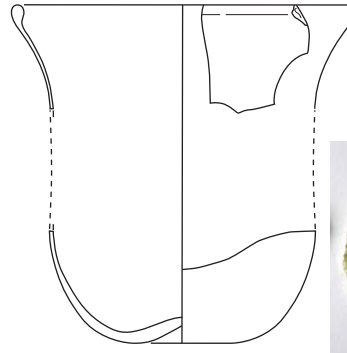
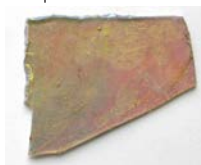

981

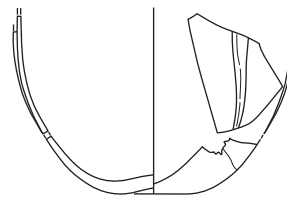
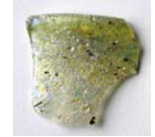

982



980

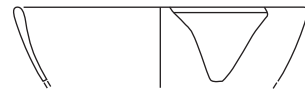

983

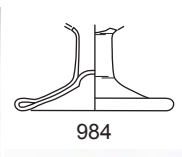
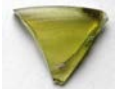

984

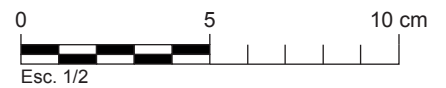

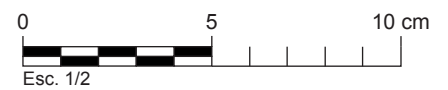
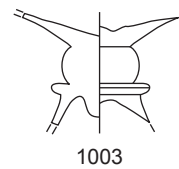
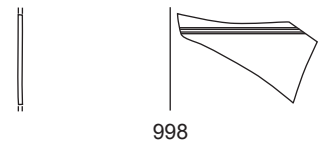
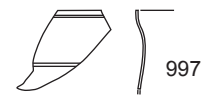
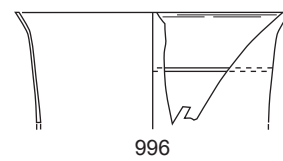
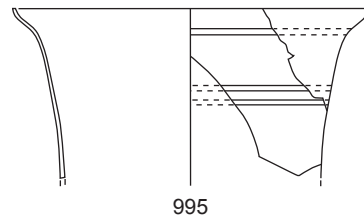
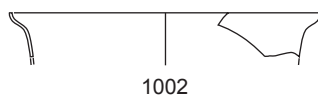
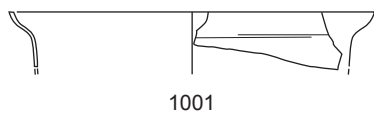
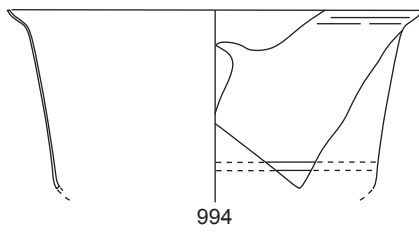
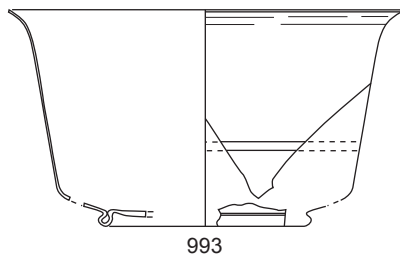
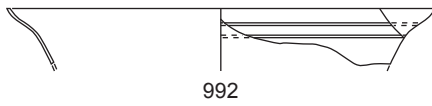

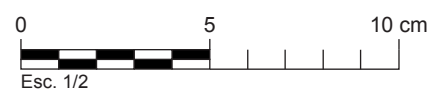
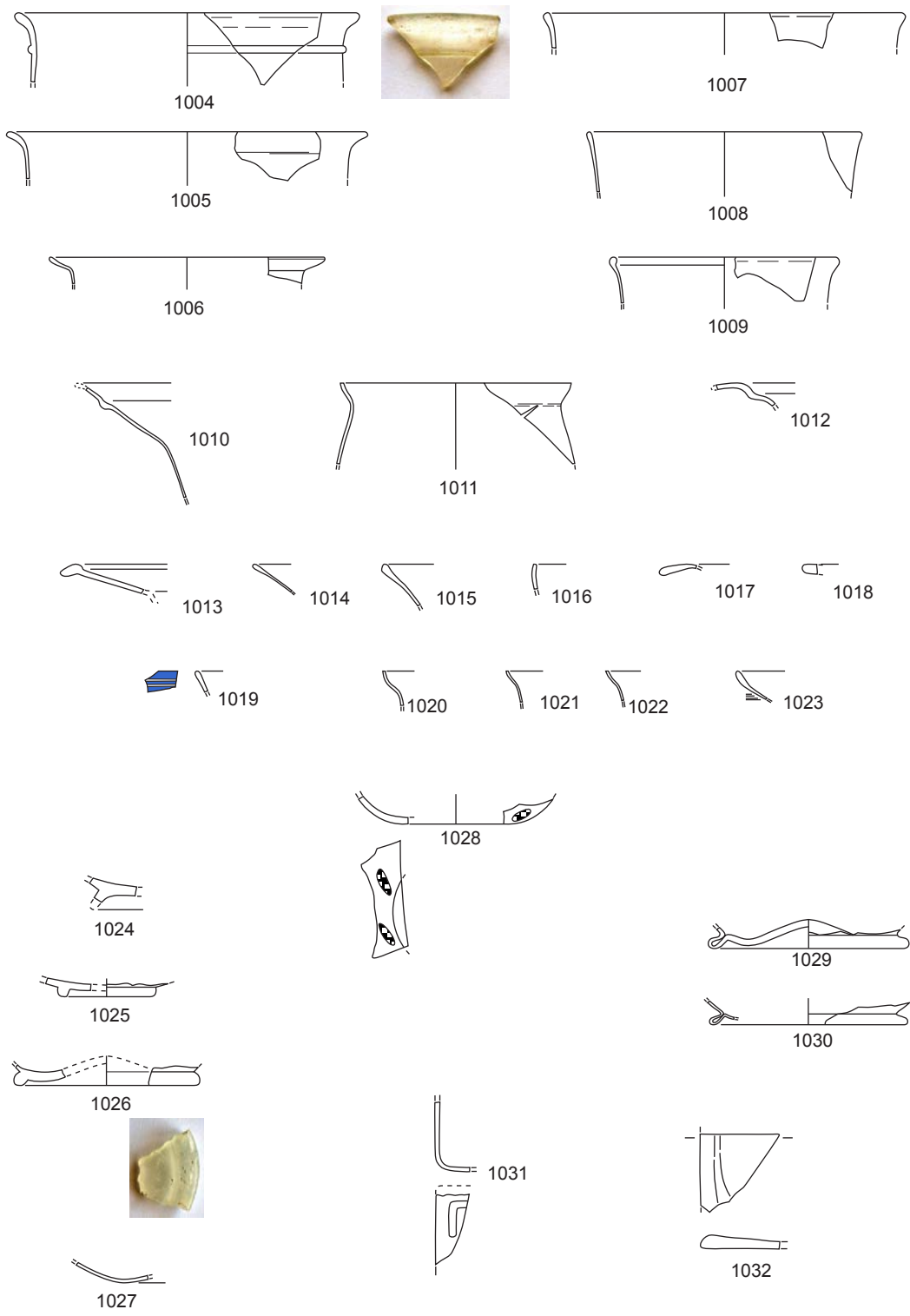

UE.10719

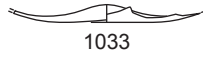

1033

UE.10738

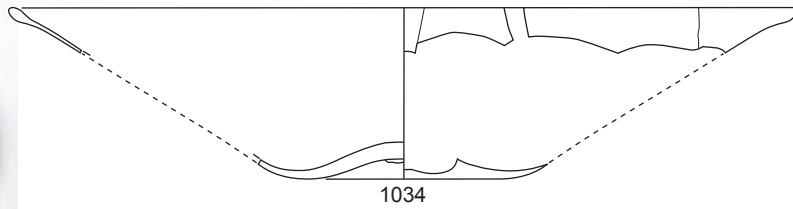

1034

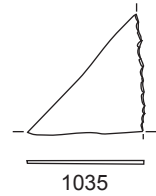

1035

UE.10748

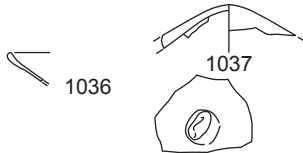

1036

1037

UE.10755

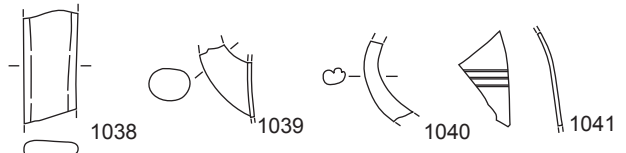

1038

1039

1040

1041

UE.10756

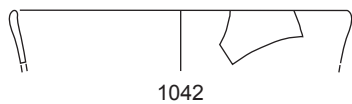

1042

UE.10766

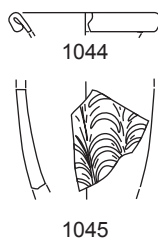

1044

1045

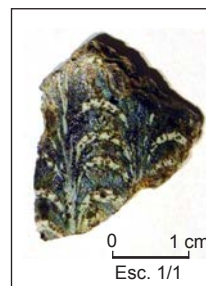

0 1 cm  
Esc. 1/1

UE.10783

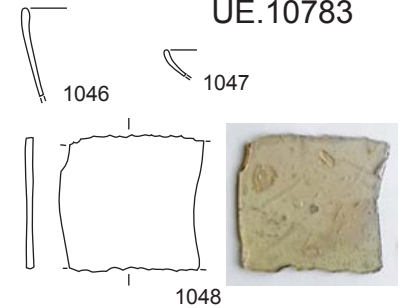

1046

1047

1048

UE.10758

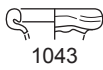

1043

UE.10790

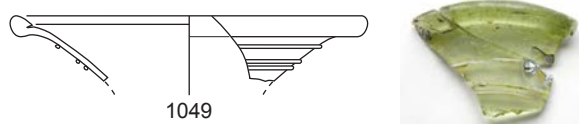

1049

UE.10825

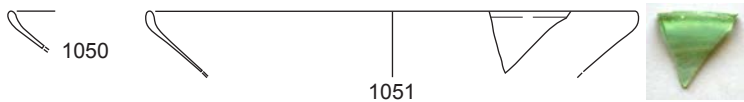

1050

1051

UE.10826

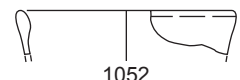

1052

UE.10833

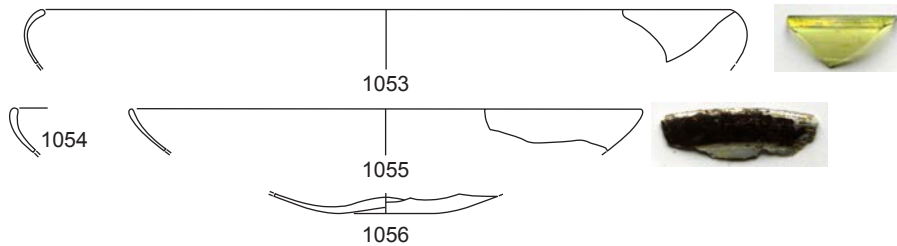

1053

1054

1055

1056

UE.10836

1057

UE.10840

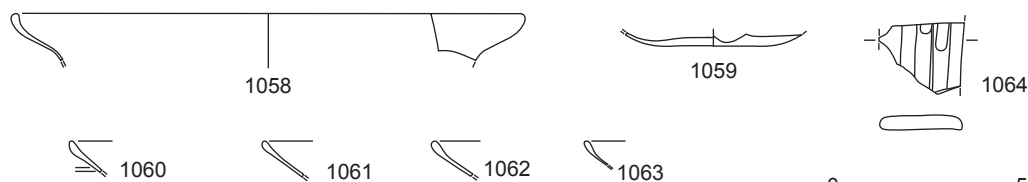

1058

1059

1064

1060

1061

1062

1063

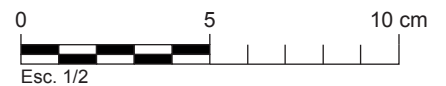

0 5 10 cm  
Esc. 1/2

UE.10867

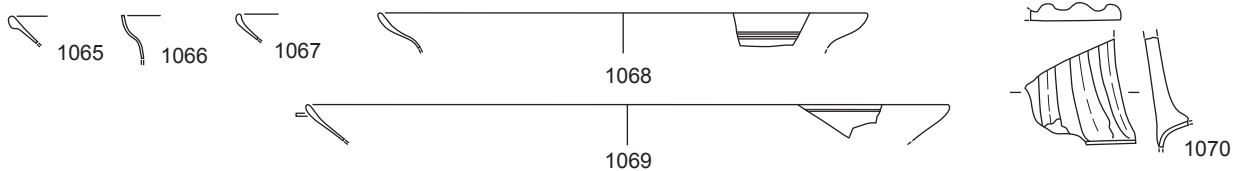

UE.10875

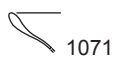

UE.10877

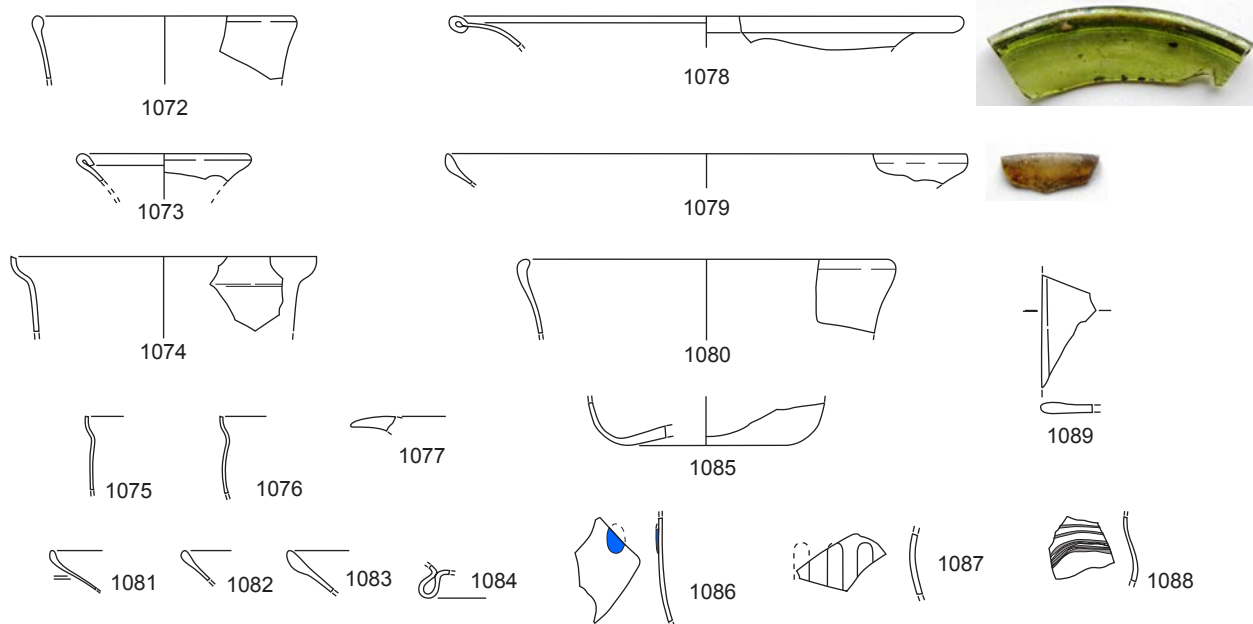

UE.10878

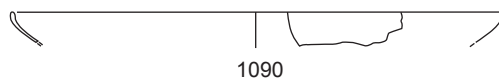

UE.10885

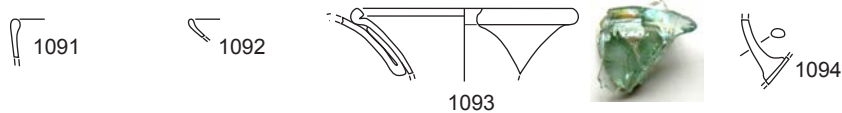

UE.10888

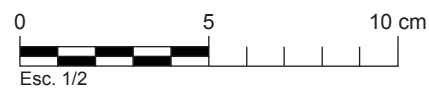
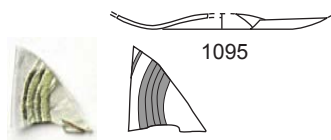

UE.10900

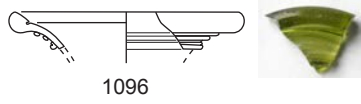

1096

UE.10913

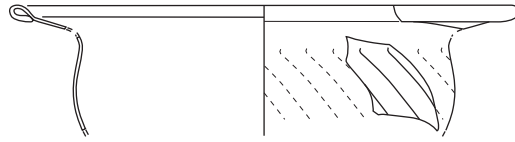

1097



UE.10938



1098



1099



1100

UE.10943

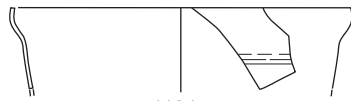

1101

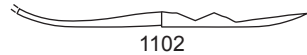

1102

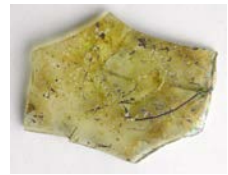
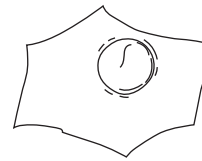

UE.10951

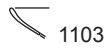

1103



1104



1105



UE.10991

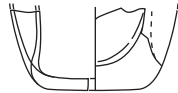

1106

UE.10996

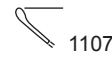

1107

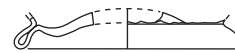

1108

UE.101019

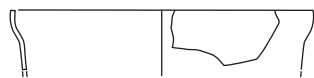

1109



1110



1111

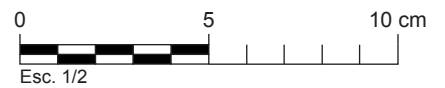



UE.101022

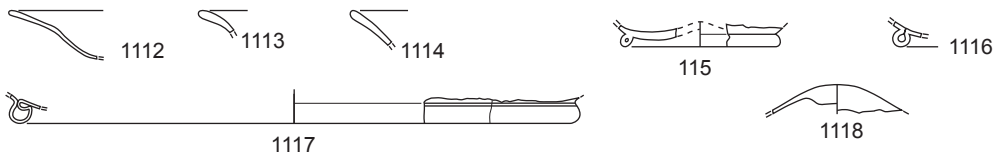

UE.101039

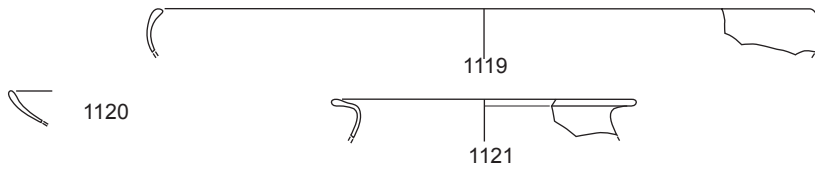

UE.101040

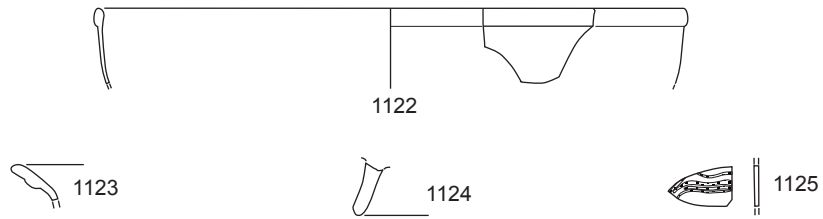

UE.101042

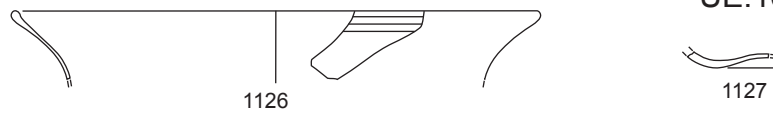

UE.101054

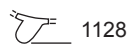

UE.101056

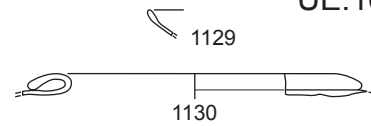

UE.101091

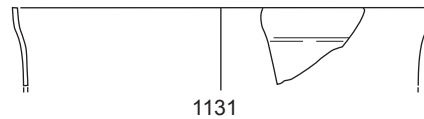

UE.101110



UE.101122

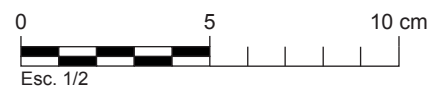
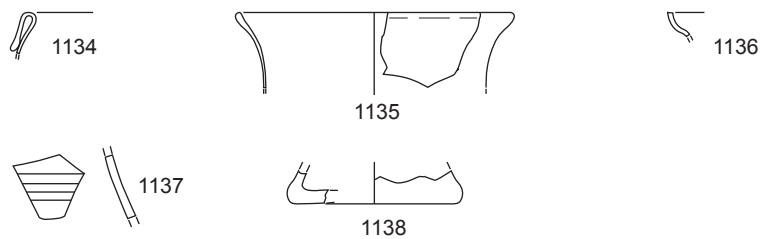

UE.101124

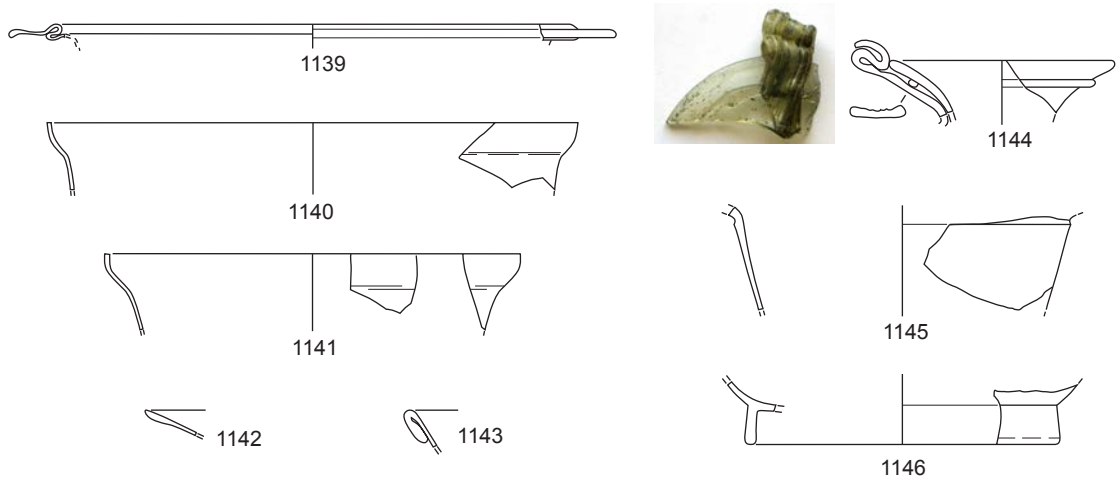

UE.101144



UE.101146

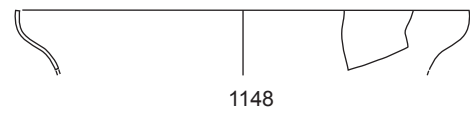

UE.101151

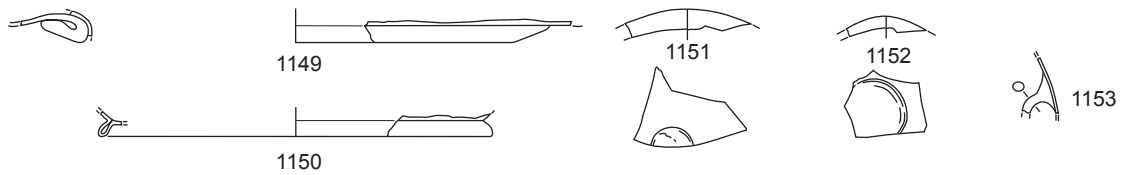

Sector 11

UE.11031

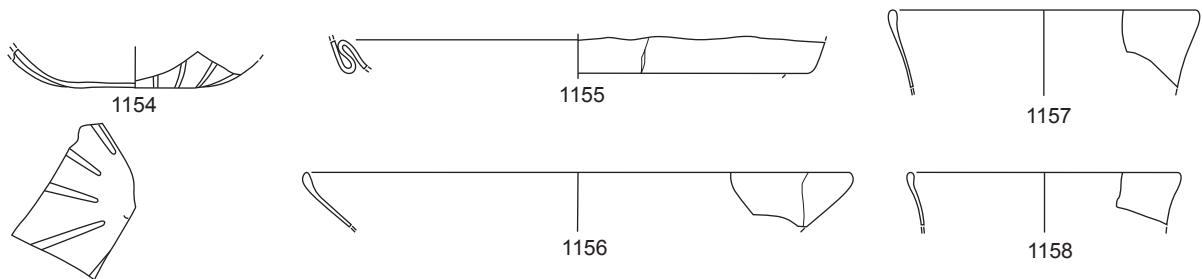

UE.11084

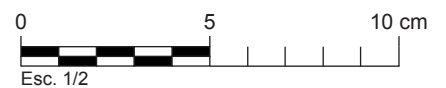
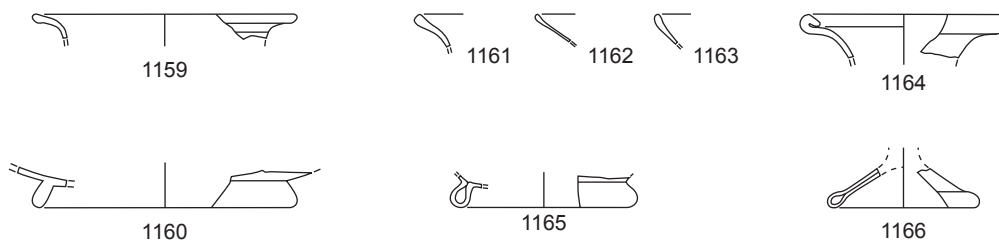

UE.12018

UE.12044

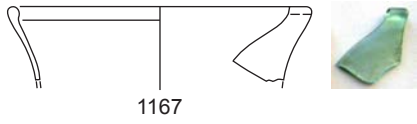

1167

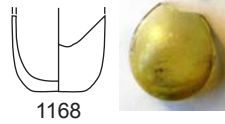

1168

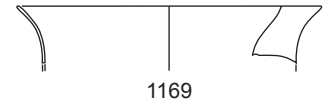

1169

UE.12511

UE.12055

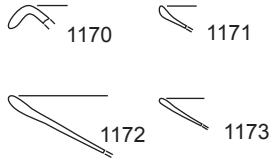

1170

1171

1172

1173



1174

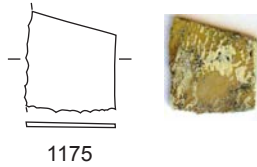

1175



1176

UE.12058

UE.12070

UE.12078

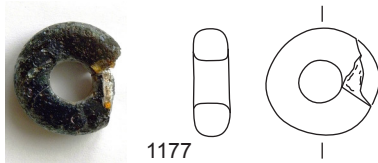

1177



1178

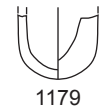

1179

UE.12117

UE.12119

UE.12126

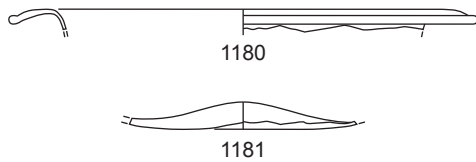

1180

1181



1182

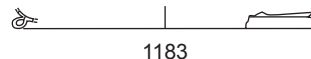

1183

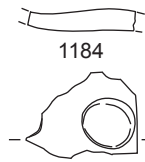

1184

UE.12142

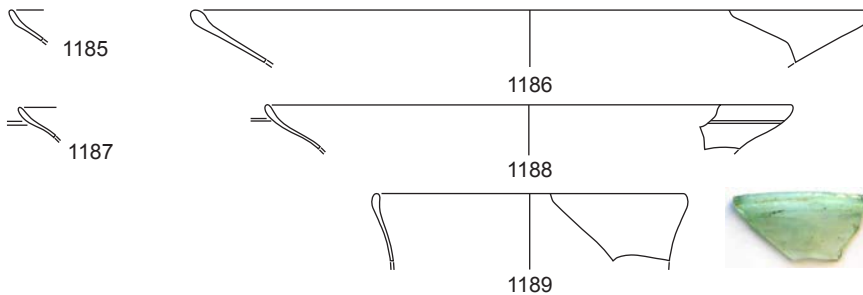

1185

1186

1187

1188

1189



UE.12160

UE.12173

UE.12175

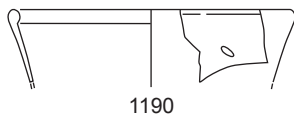

1190



1191



1192

UE.12181

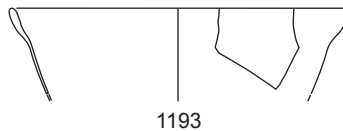

1193

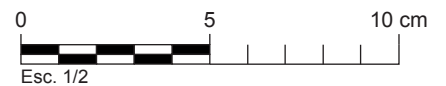

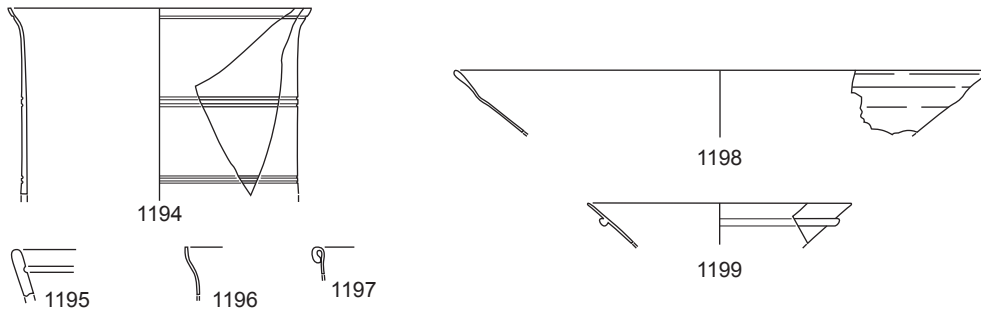

UE.12193

UE.12197

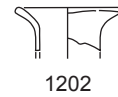
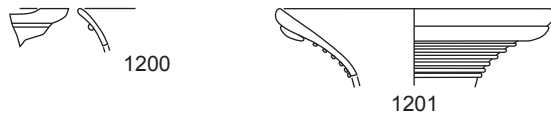

UE.12206

UE.12208

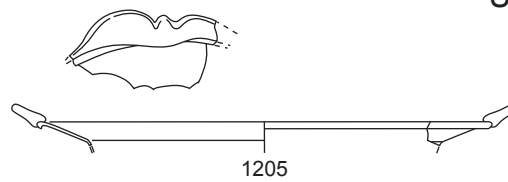

UE.12229

UE.12230

UE.12240

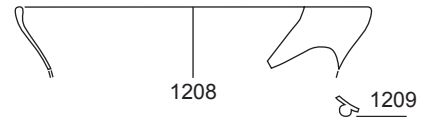
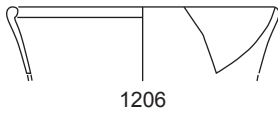

UE.12237

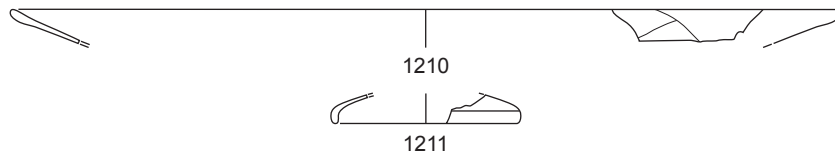

UE.12256

UE.12260

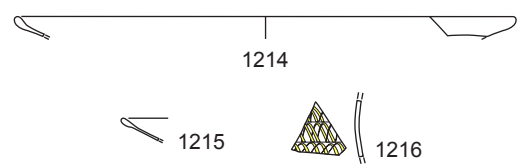
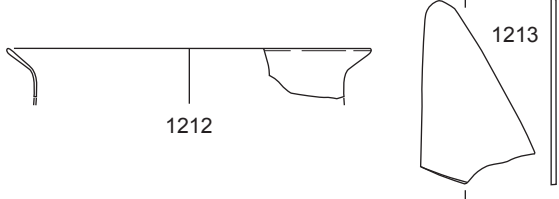

UE.12270

UE.12274

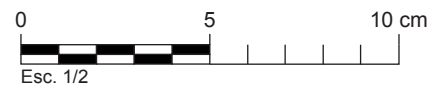
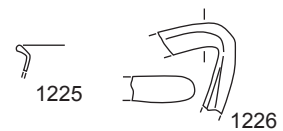
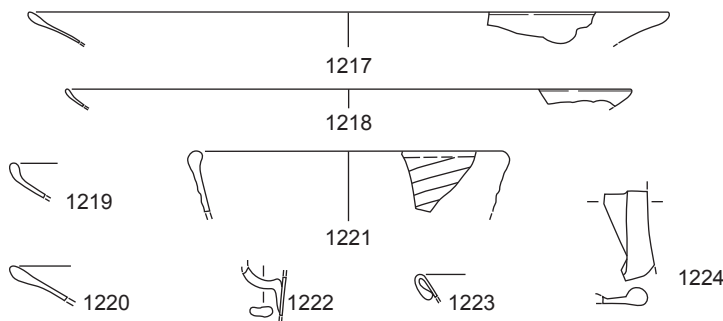

UE.12276



UE.12278



UE.12281

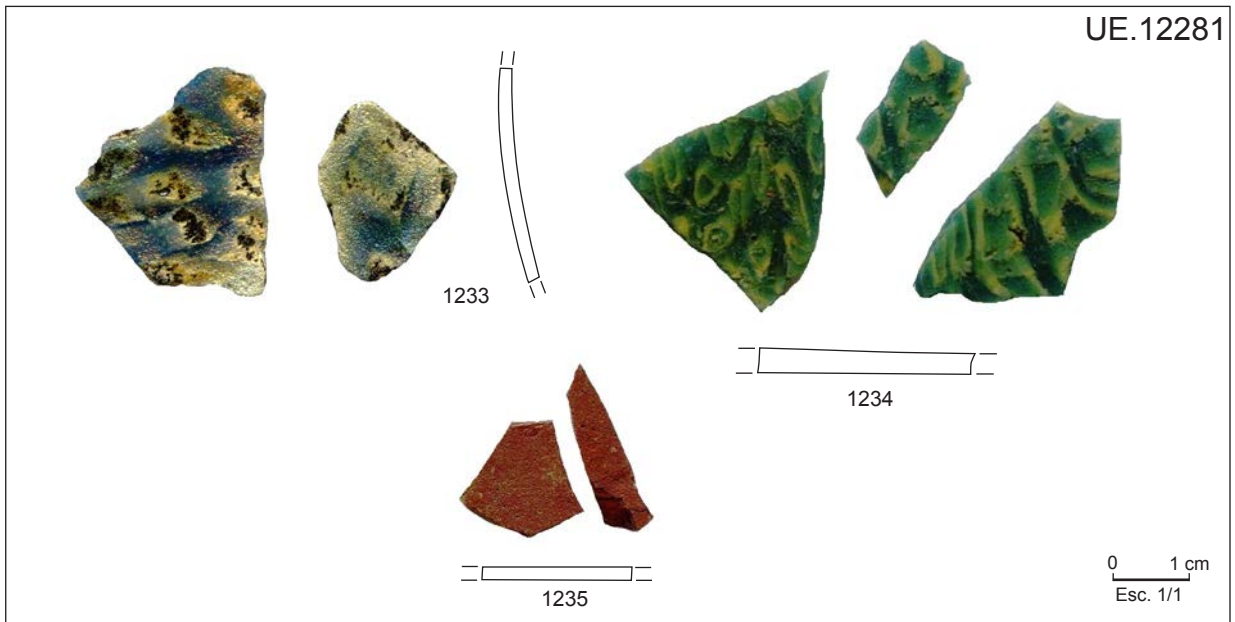
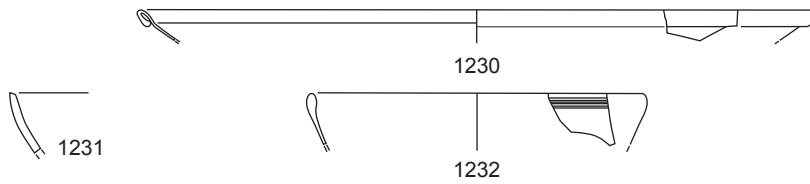

UE.12302

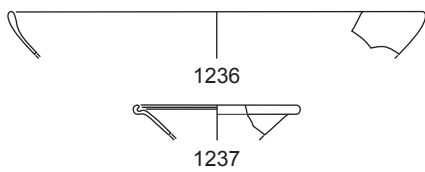

UE.12307

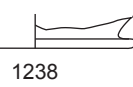
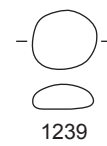

UE.12309

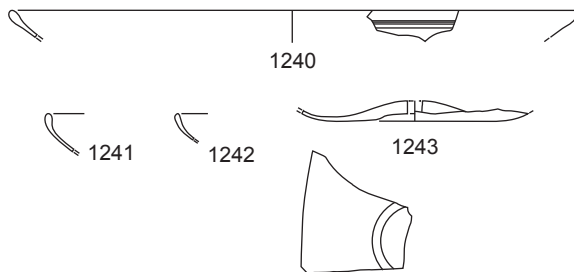

UE.12310

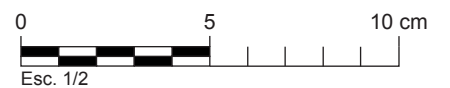
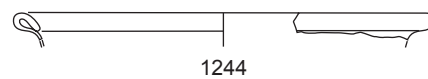

UE.12316

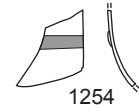
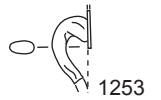
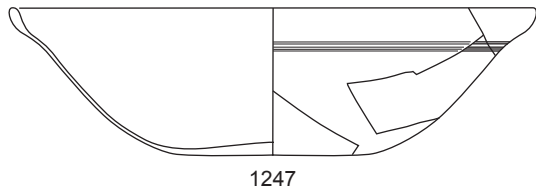
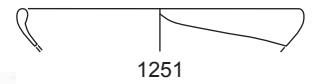
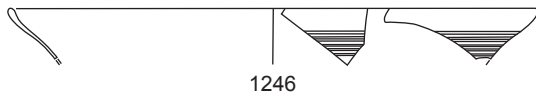
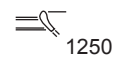
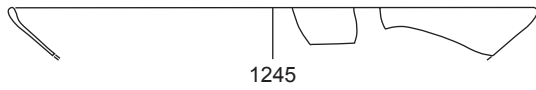

UE.12326

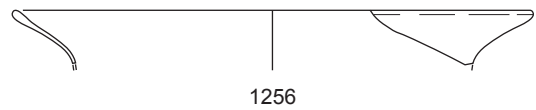
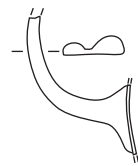
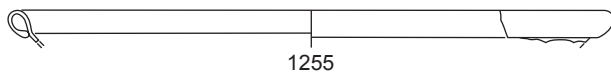

UE.12327

UE.12328

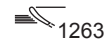
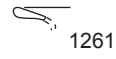

UE.12340



UE.12345

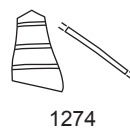
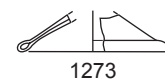
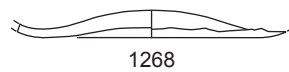
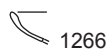
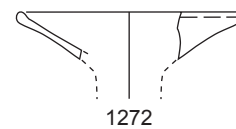

UE.12357

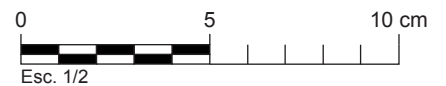

UE.12362

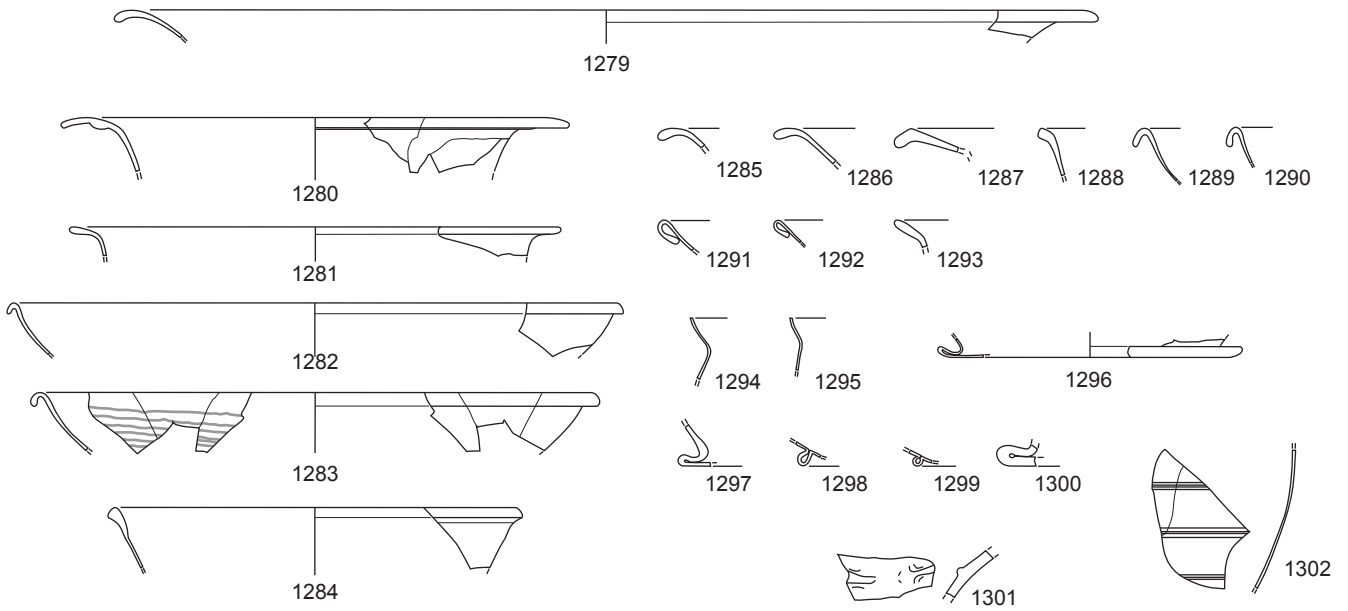

UE.12364

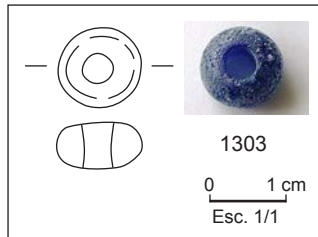

UE.12366

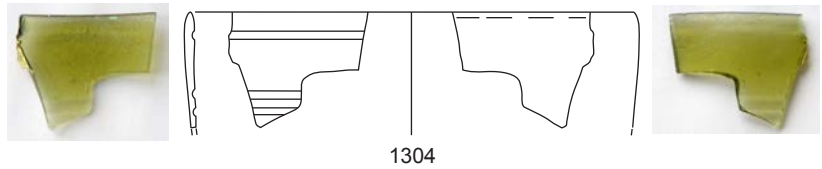

UE.12383

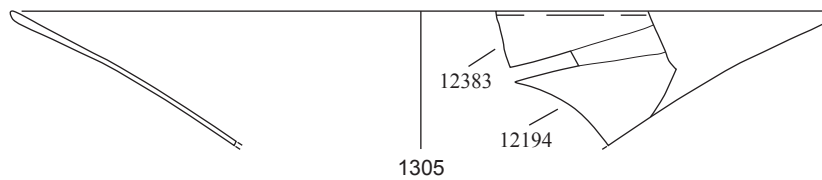

UE.12390



UE.12399

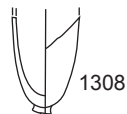

UE.12407

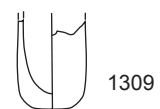

UE.12410

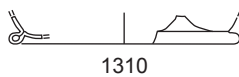

UE.12414



UE.12416

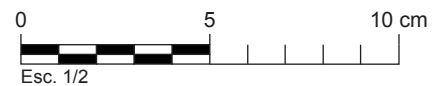

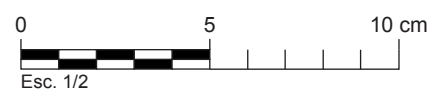
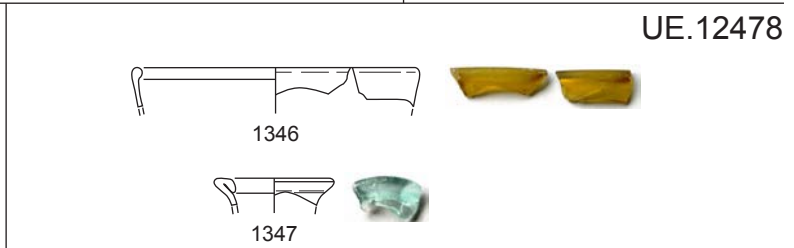
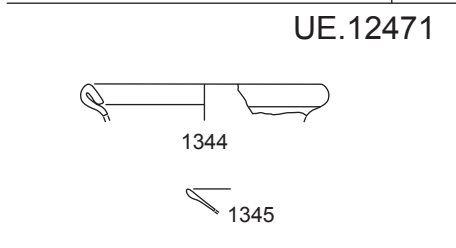
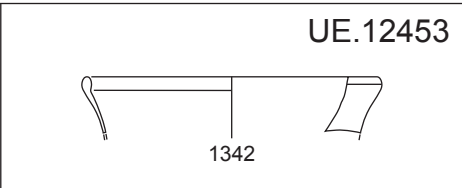
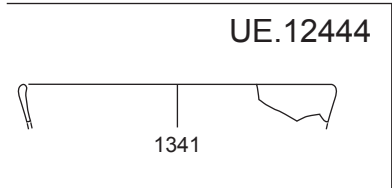
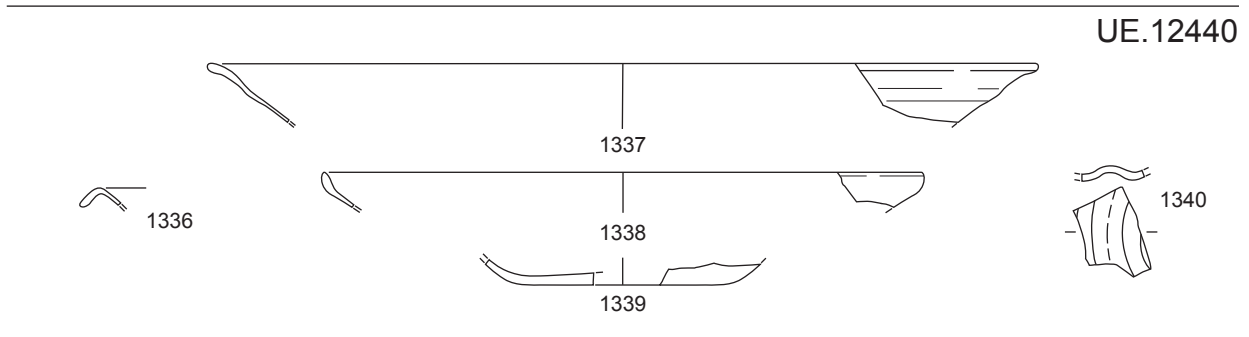
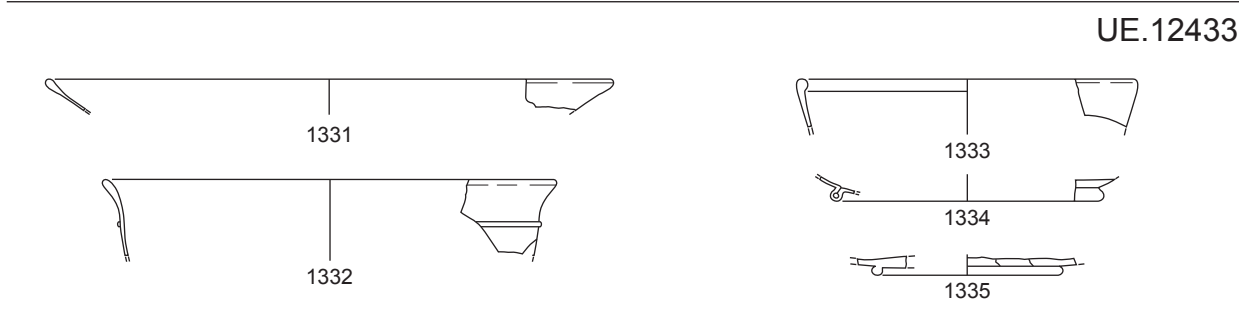
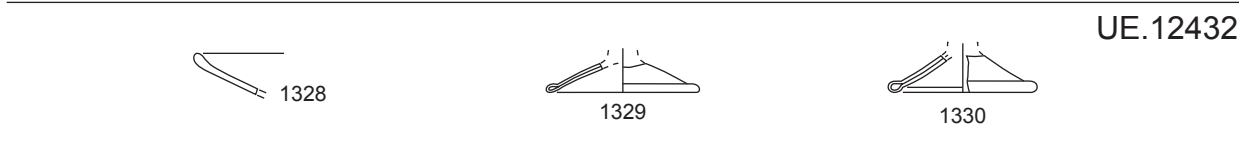
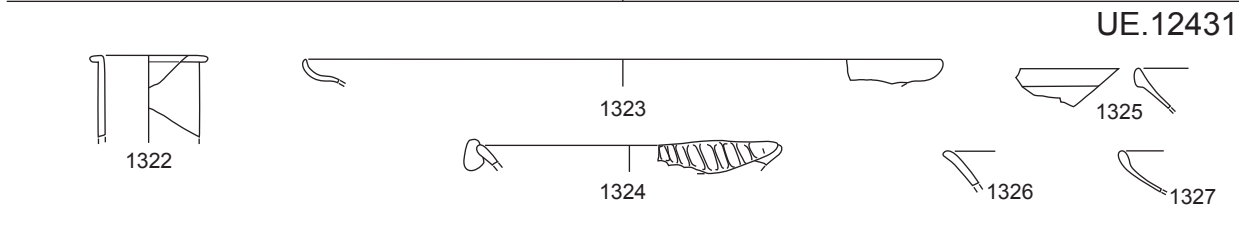
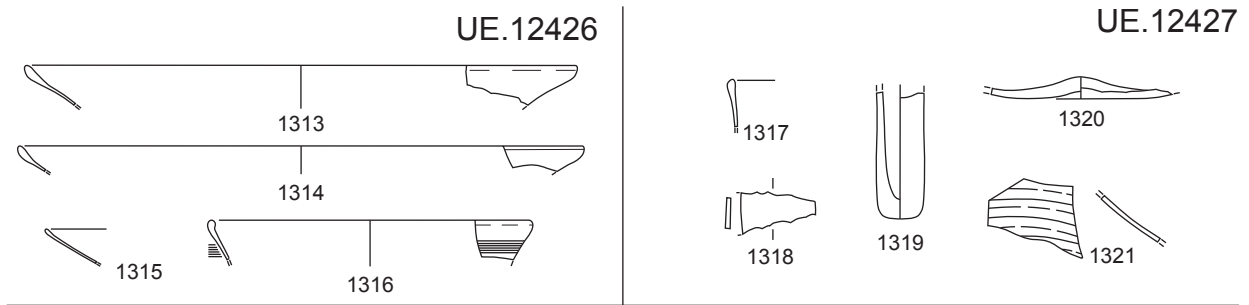



UE.12479

UE.12480

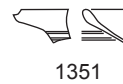
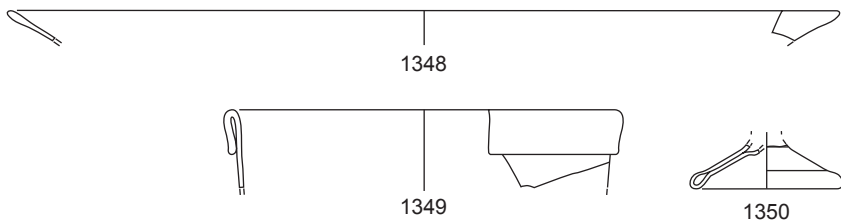

UE.12484

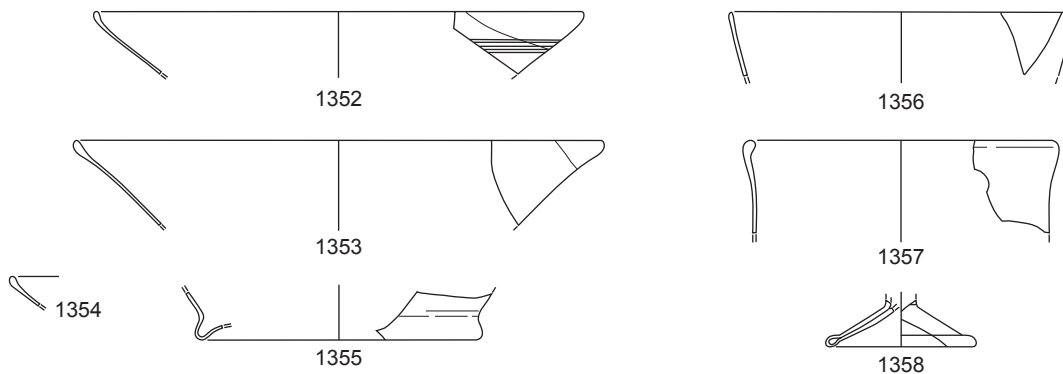

UE.12487

UE.12488

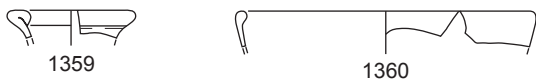

UE.12502

UE.12509

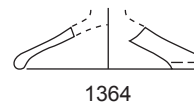
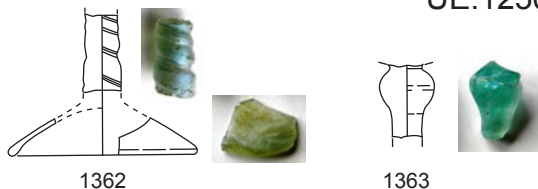

UE.12519

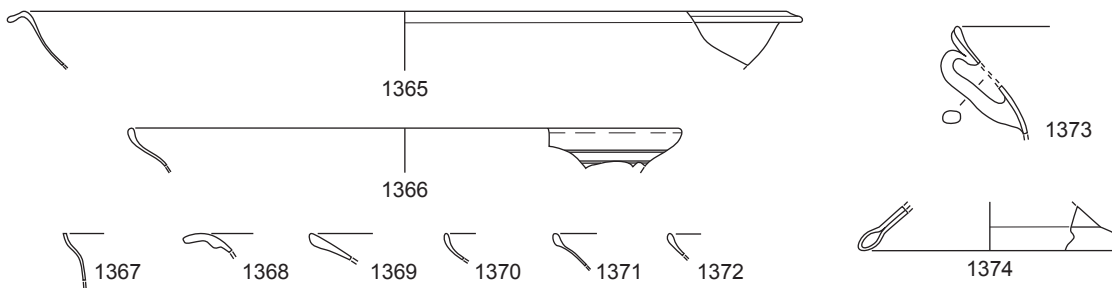

UE.12522

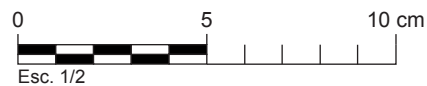

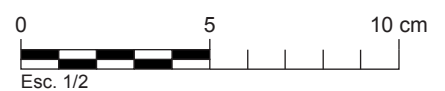
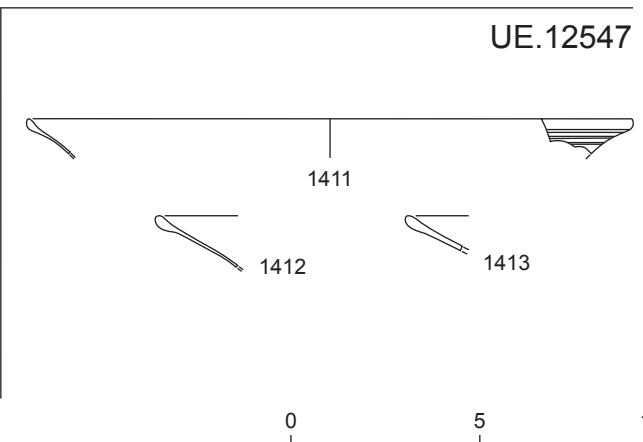
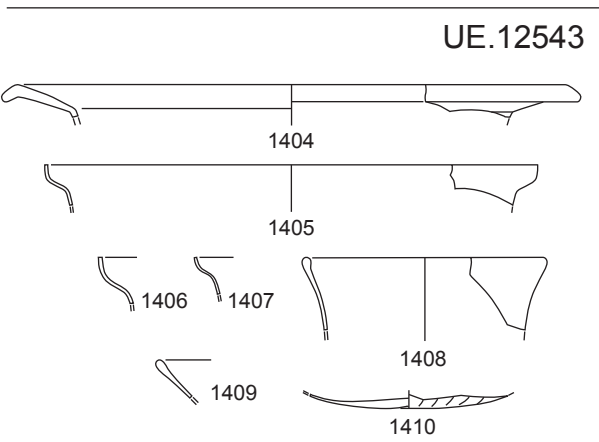
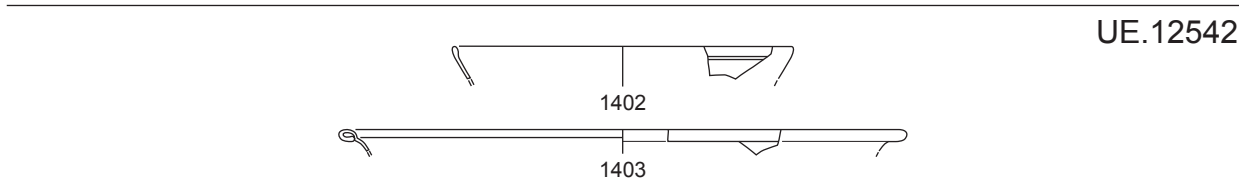
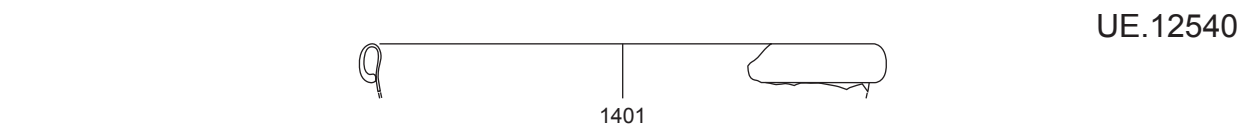
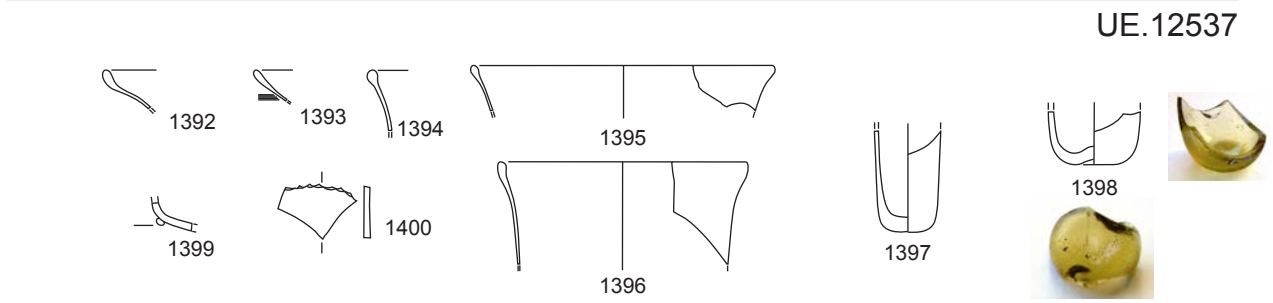
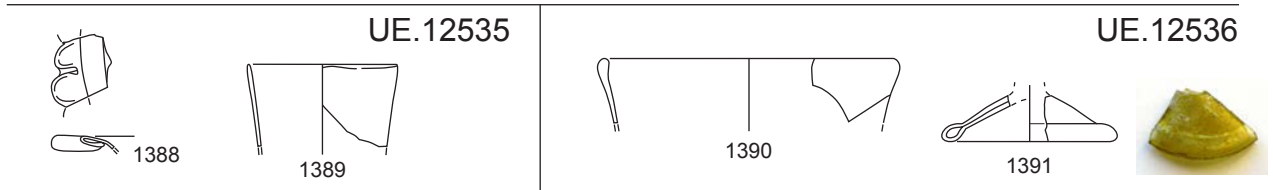
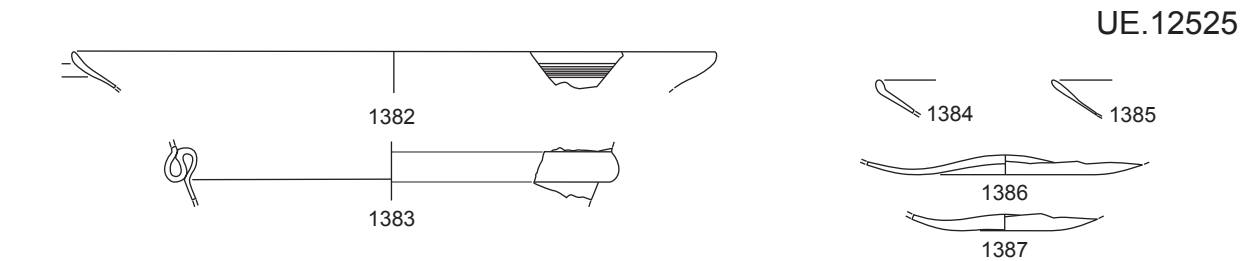
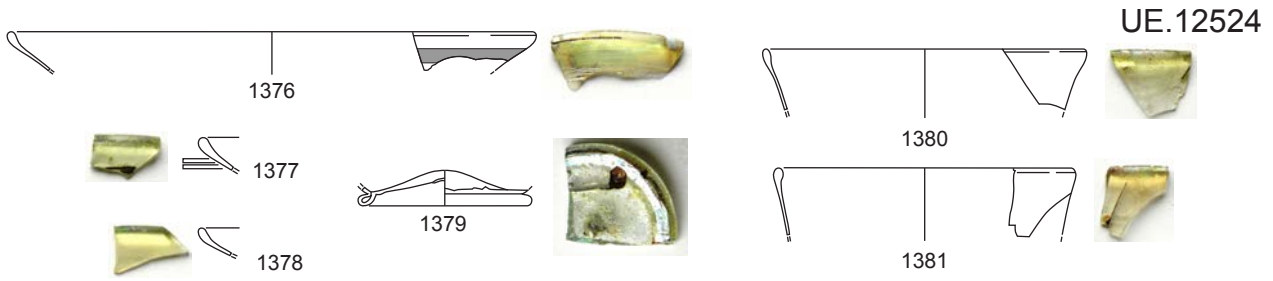

UE.12552

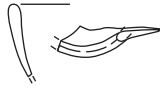

1414

UE.12557



1415

UE.12559



1416

UE.12561



1417



vidre pla de finestra

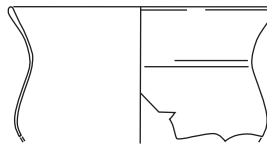

1418



UE.12572



1419

UE.12577



1420

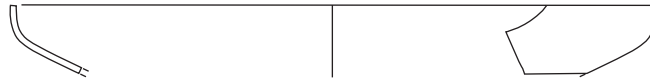

1421

UE.12595

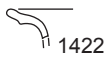

1422

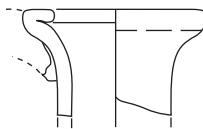

1423

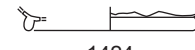

1424



1425

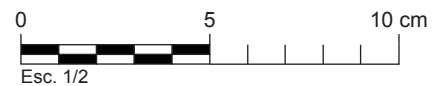
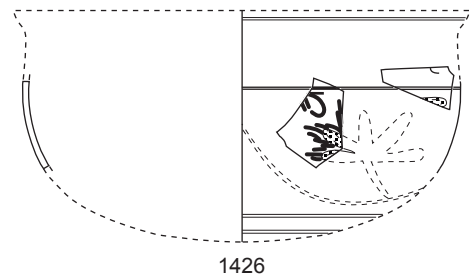
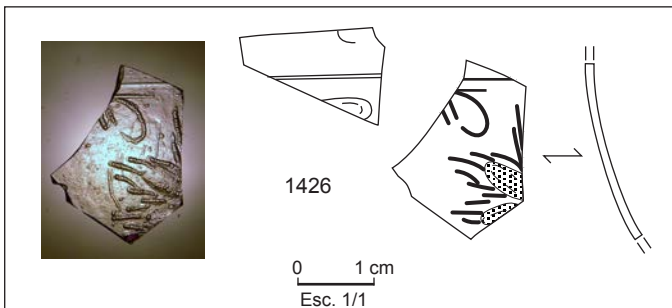

UE.12596

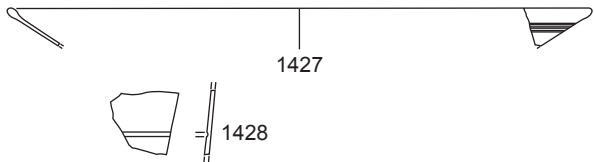

UE.12597

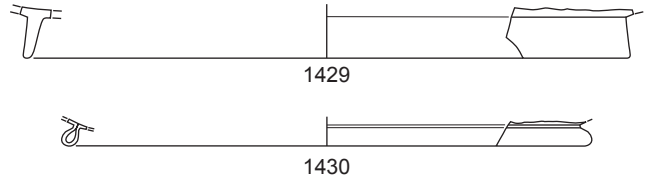

UE.12598

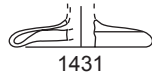

UE.12634

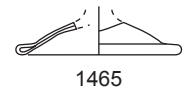
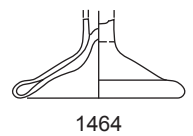
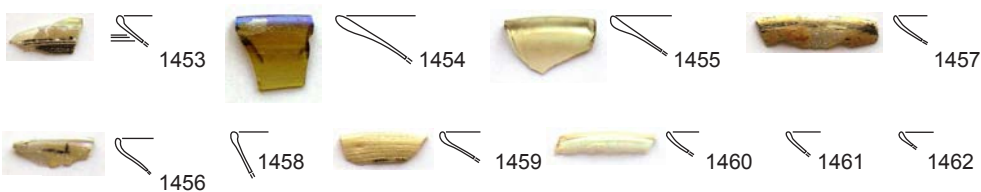
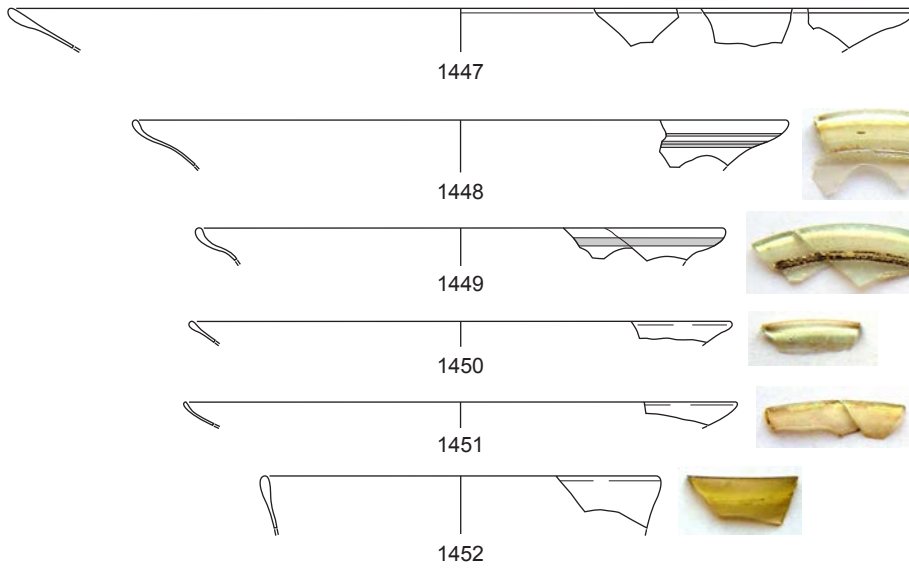
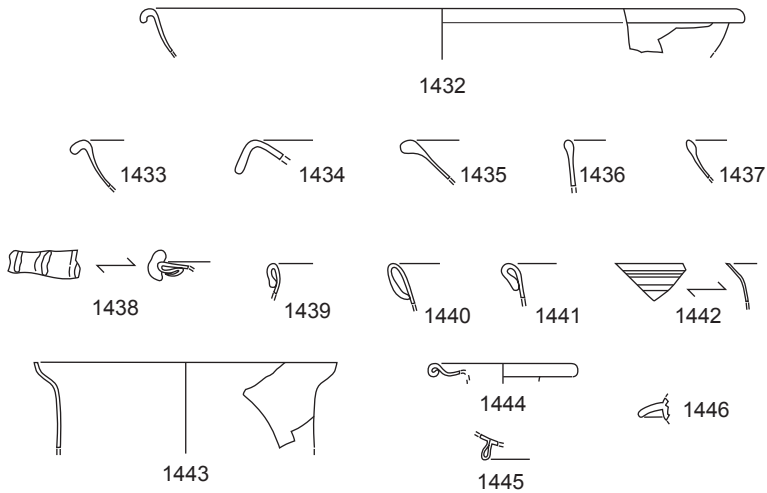

UE.12659



1466

UE.12662

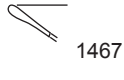

1467

UE.12670



1468

UE.12677

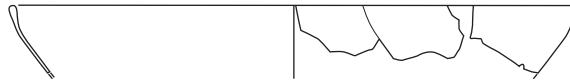

1469

UE.12693



1470

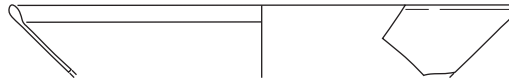

1471

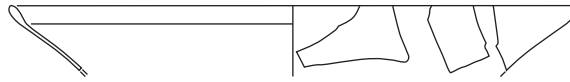

1472

UE.12758

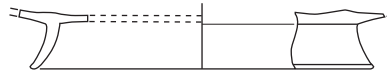

1473



UE.14035

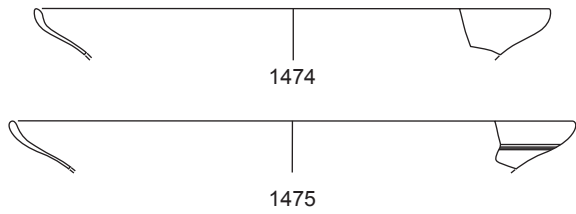

UE.14044

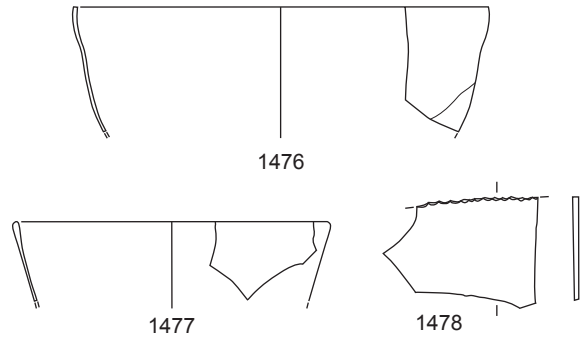

UE.14046

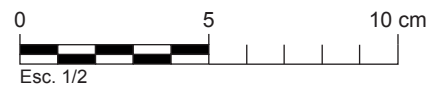
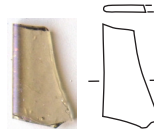
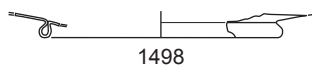
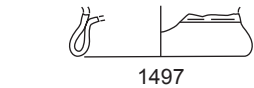
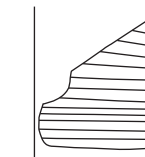
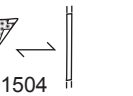
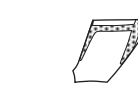
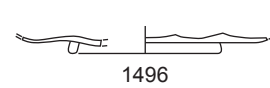
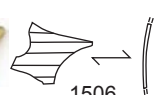
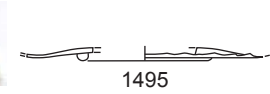
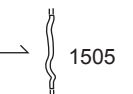
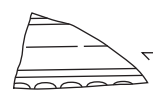
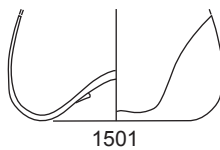
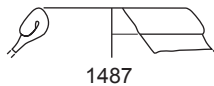
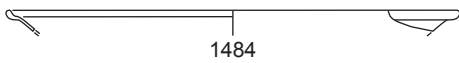
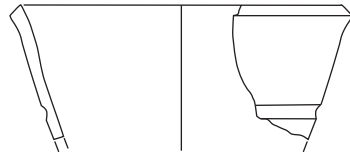
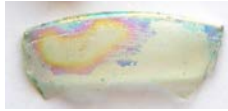
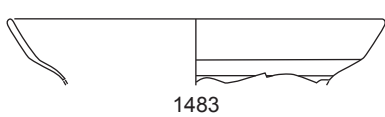
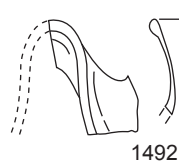
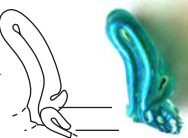
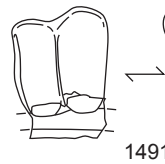
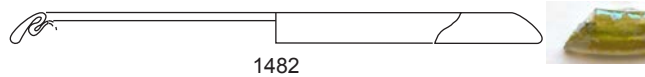
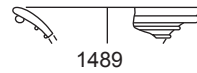
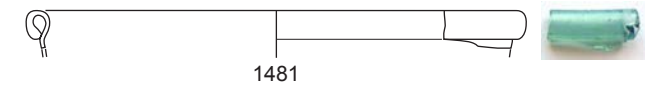
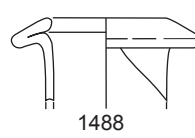
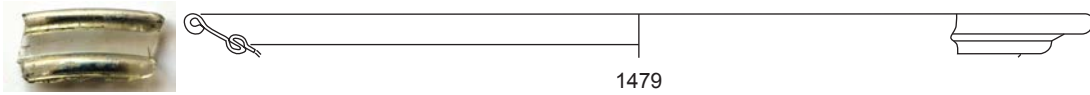

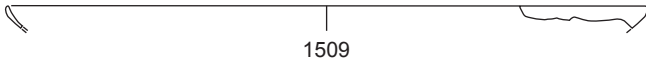

1509



1524

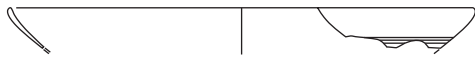

1510

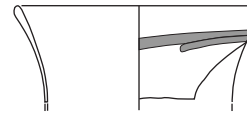
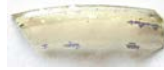

1525

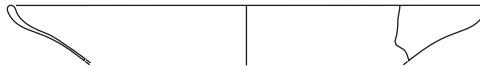
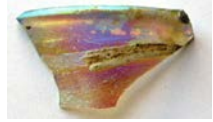

1511

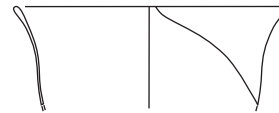

1526

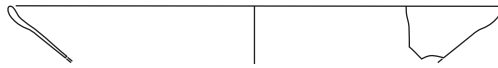

1512



1513

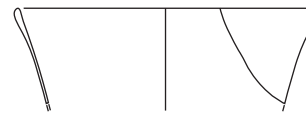

1527



1514

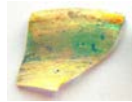

1528

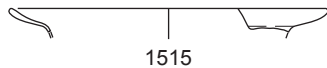

1515



1529

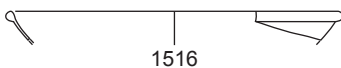

1516



1517

1518

1519

1520

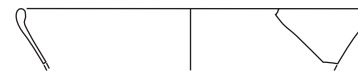

1530



1521

1522

1523



1531



1532



1533



1534

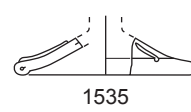

1535

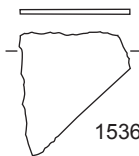

1536

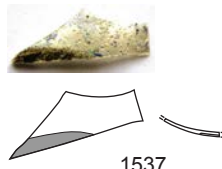

1537

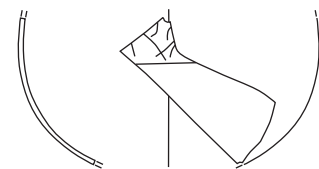

1538



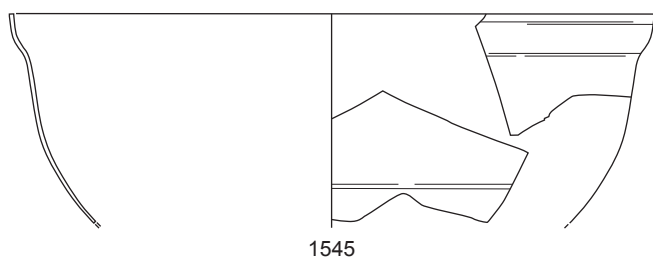
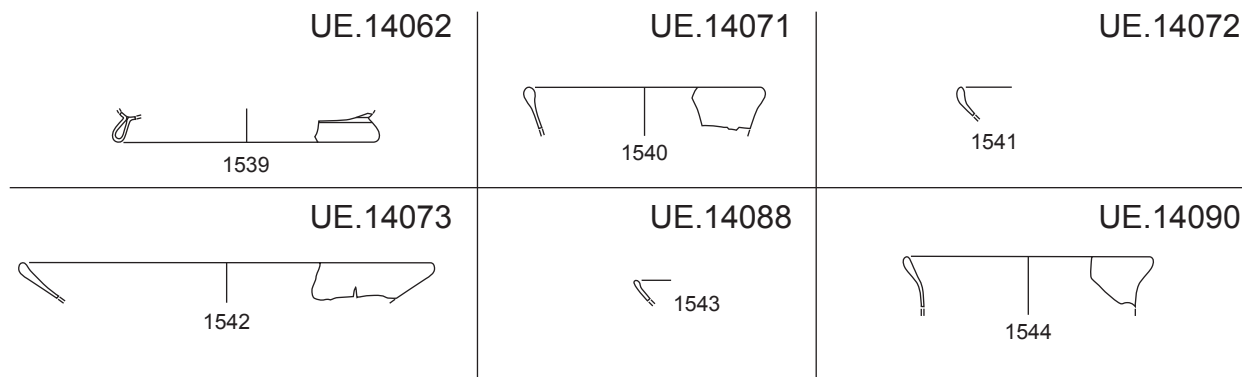

UE.14091

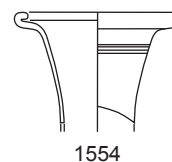
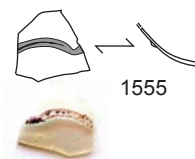
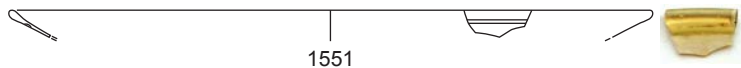
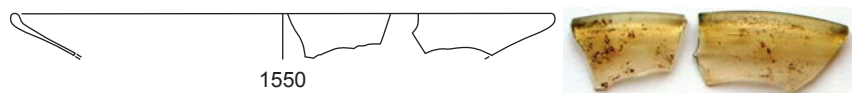
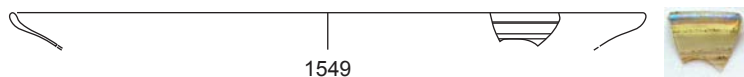
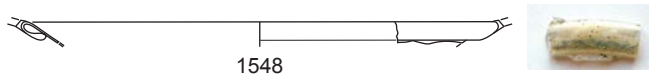
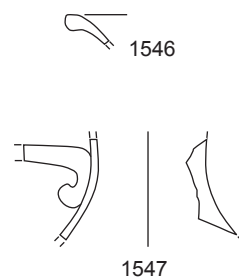

UE.14139

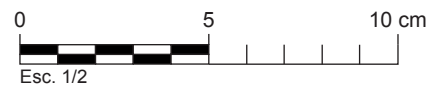
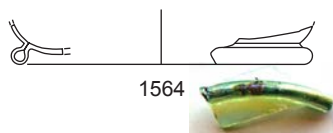
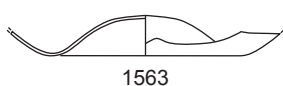
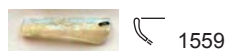
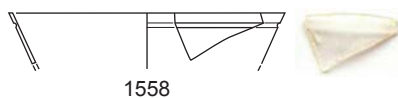
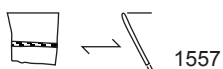



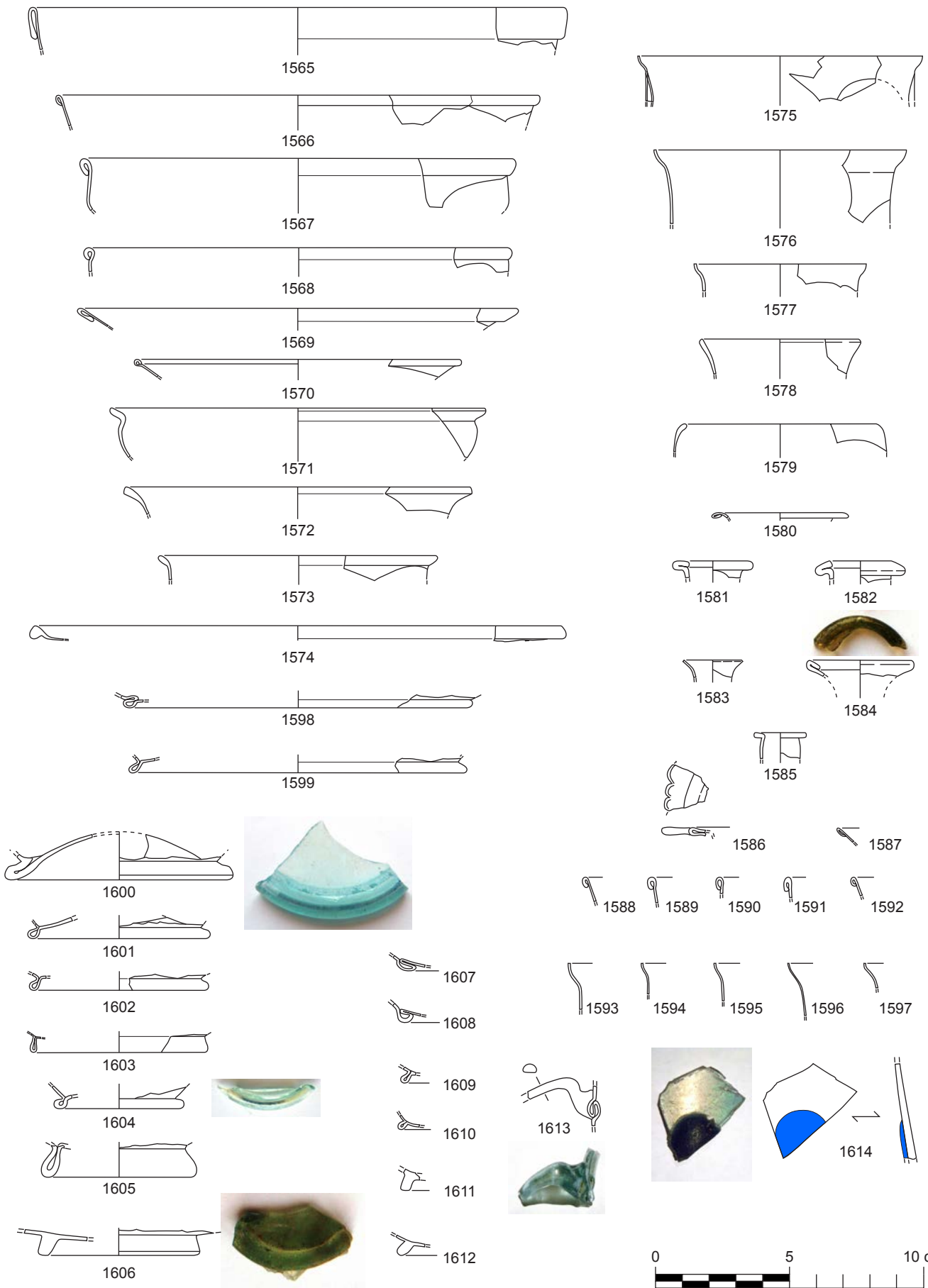

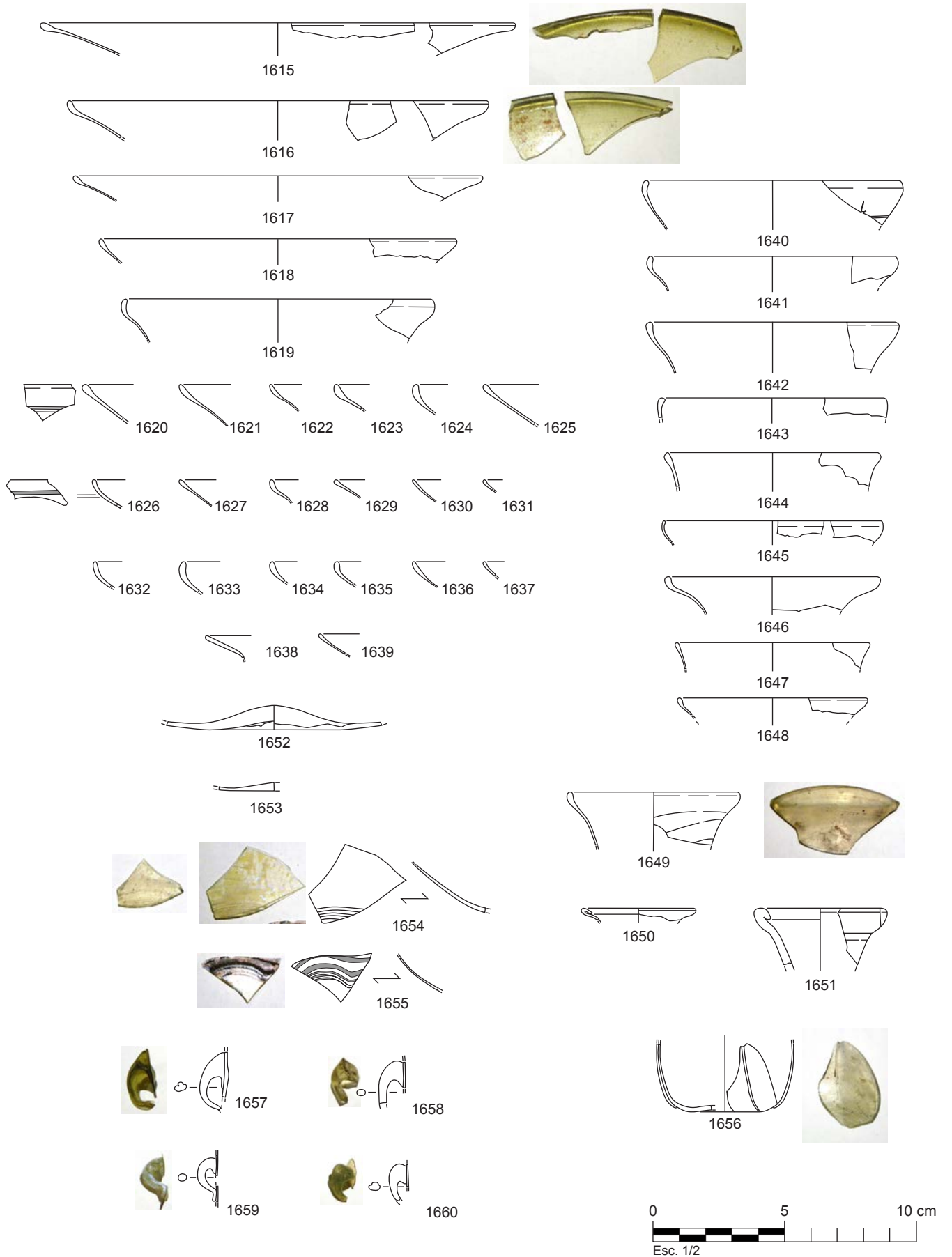

UE.14162

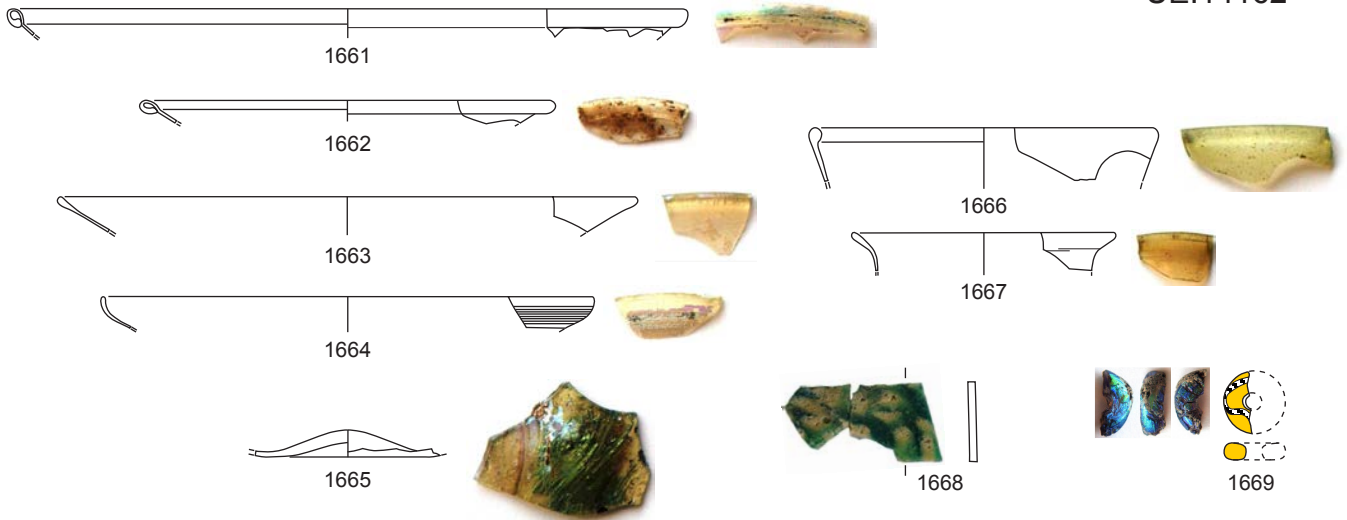

UE.14165

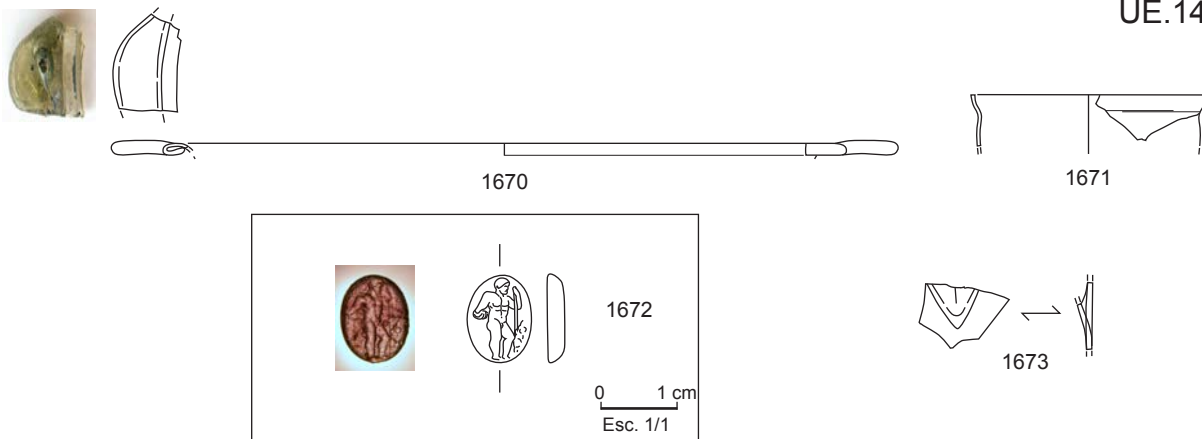

UE.14176

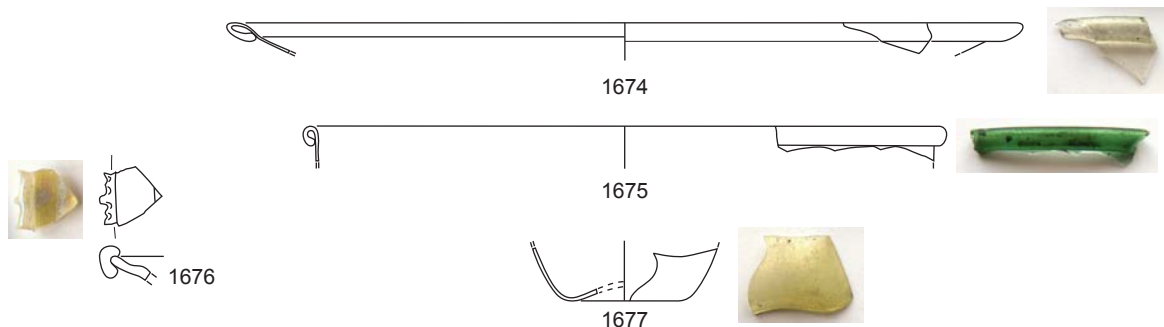

UE.14202

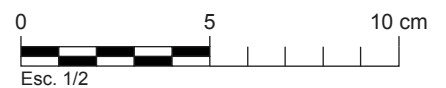

UE.15003

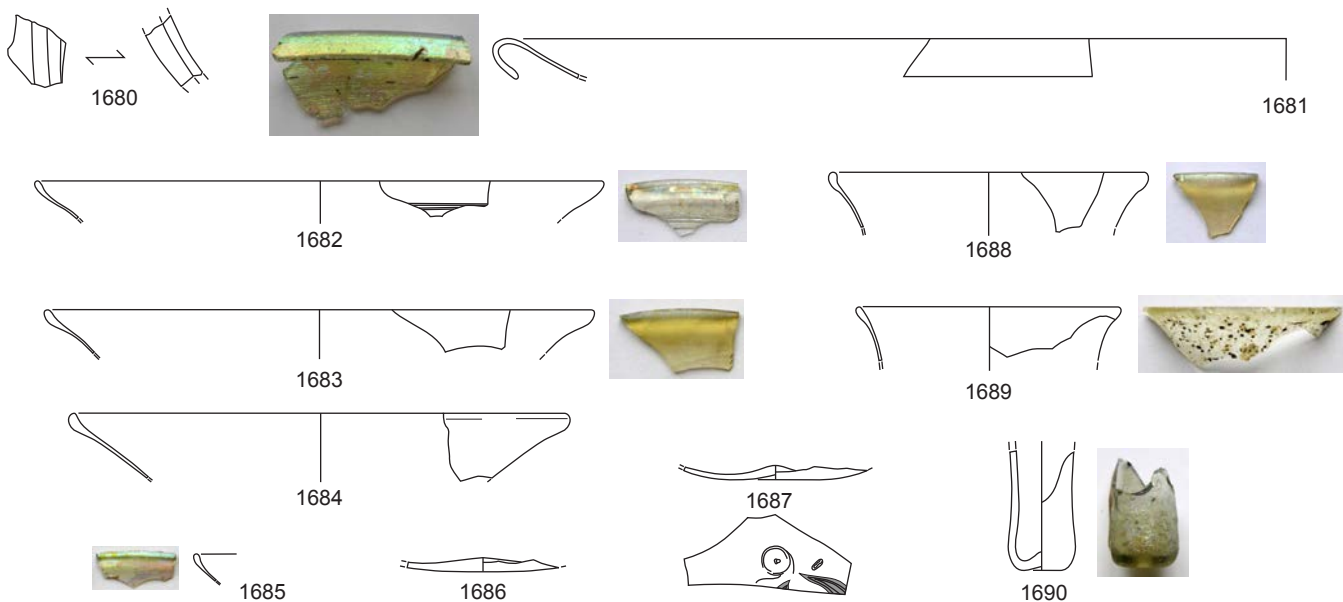

UE.15005

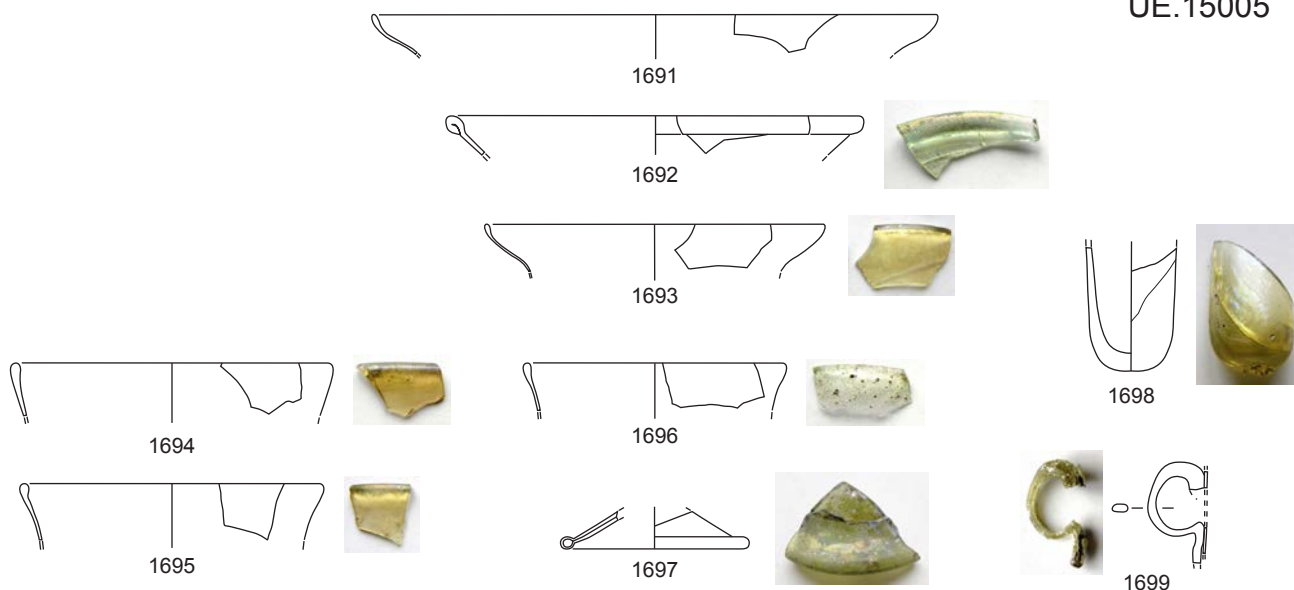

UE.15006

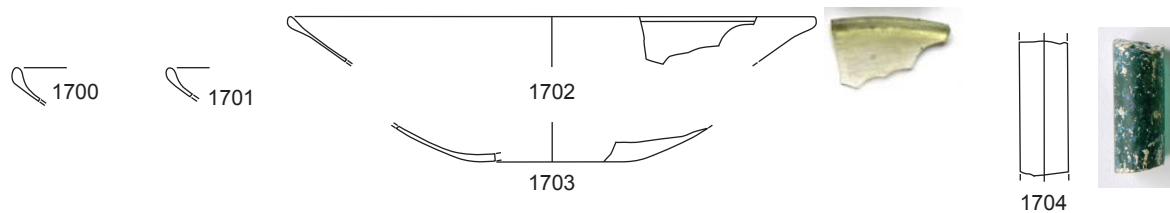

UE.15029



1705

UE.15030

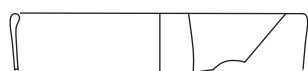

1706

UE.15037

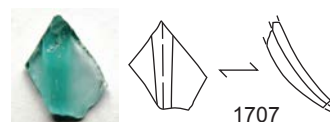

1707

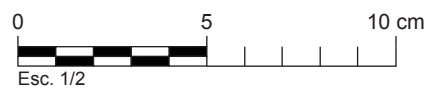

UE.15045

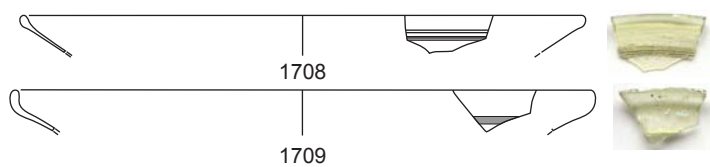

UE.15090

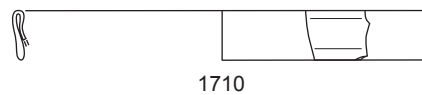

UE.15093

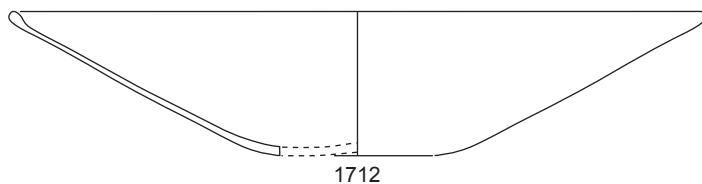
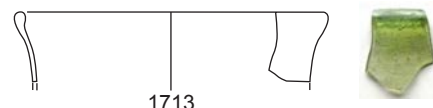

UE.15094

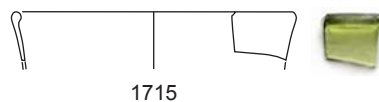

UE.15095

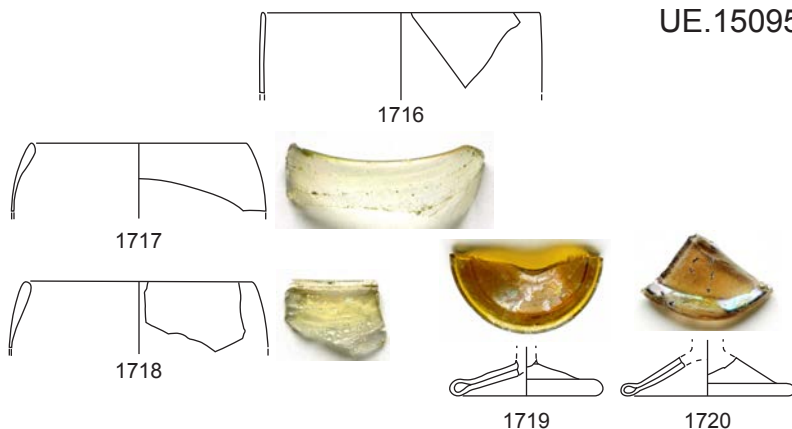

UE.15099

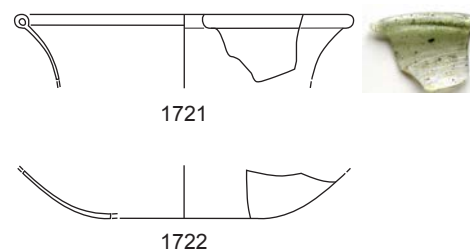

UE.15103

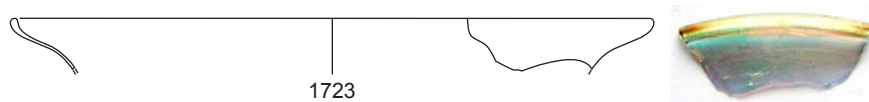

UE.15108

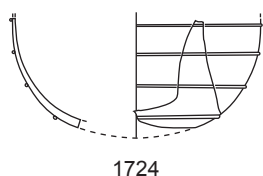

UE.15120

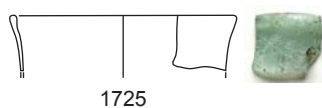

UE.15124

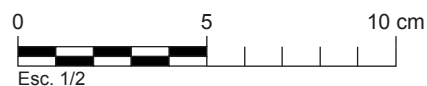

UE.15128

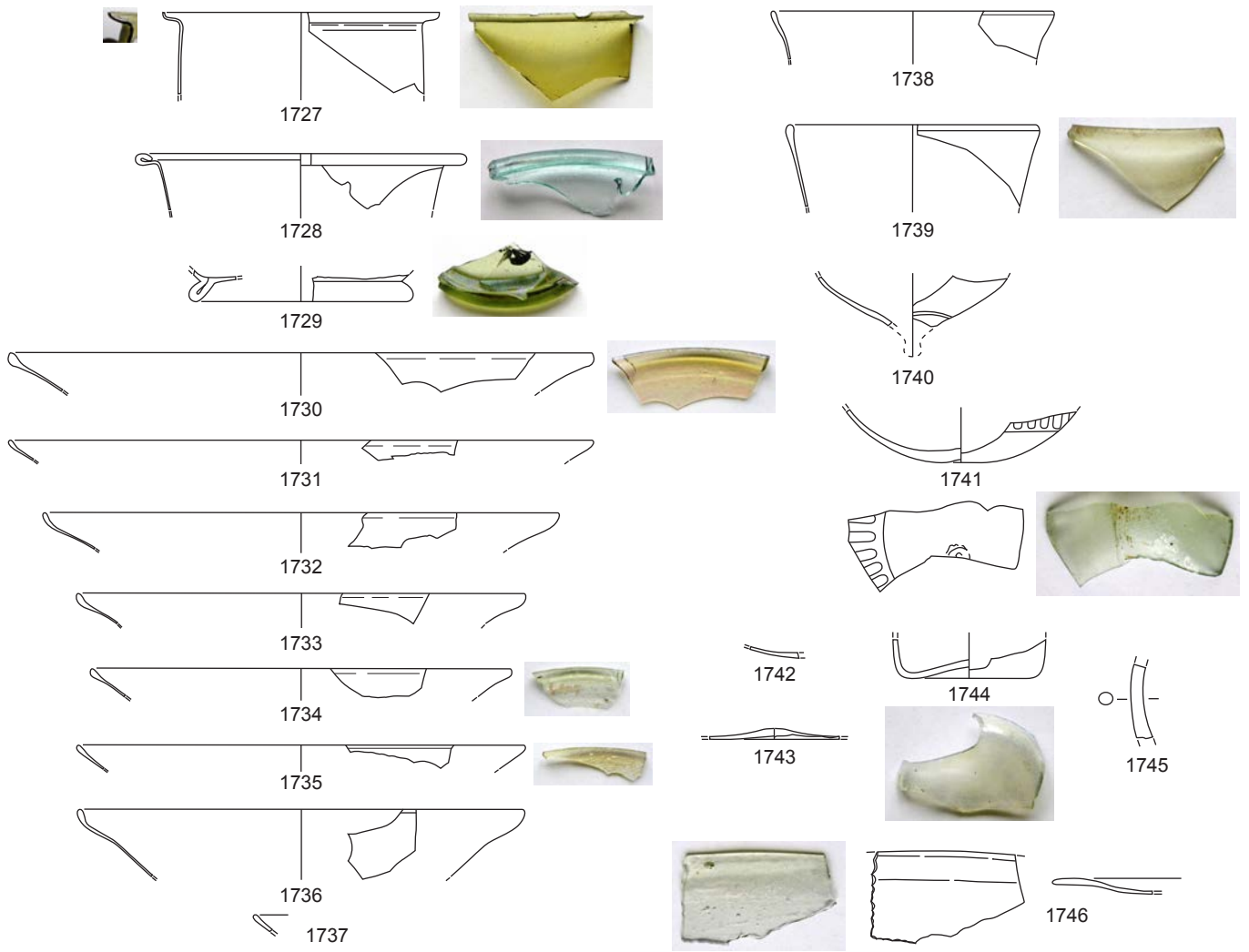

UE.15129

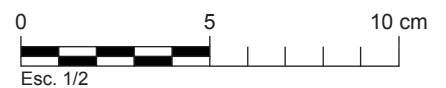
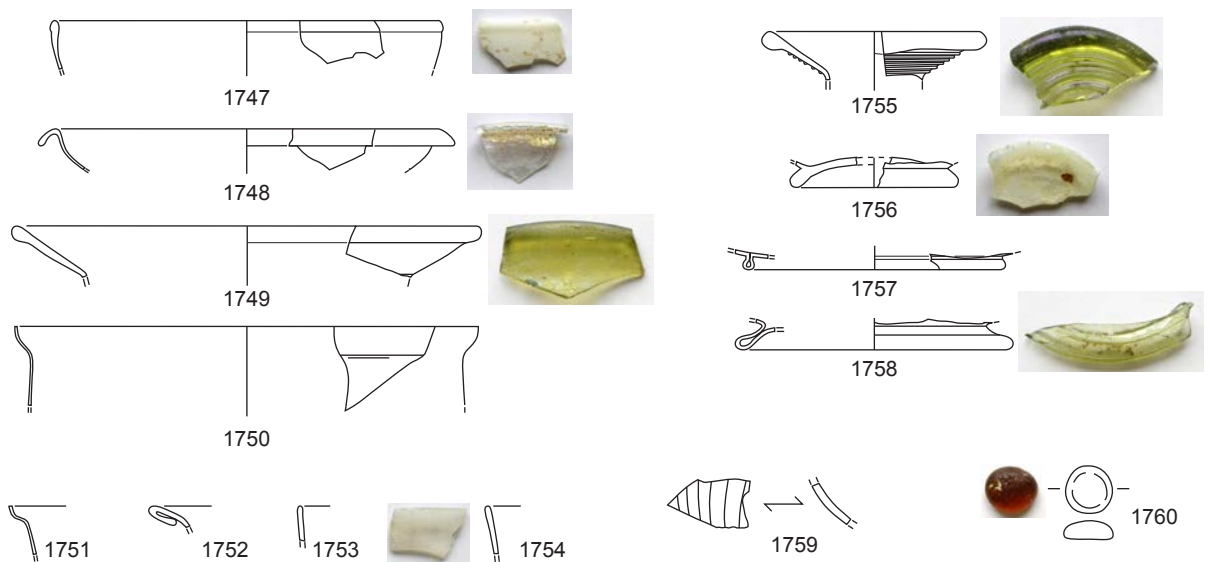

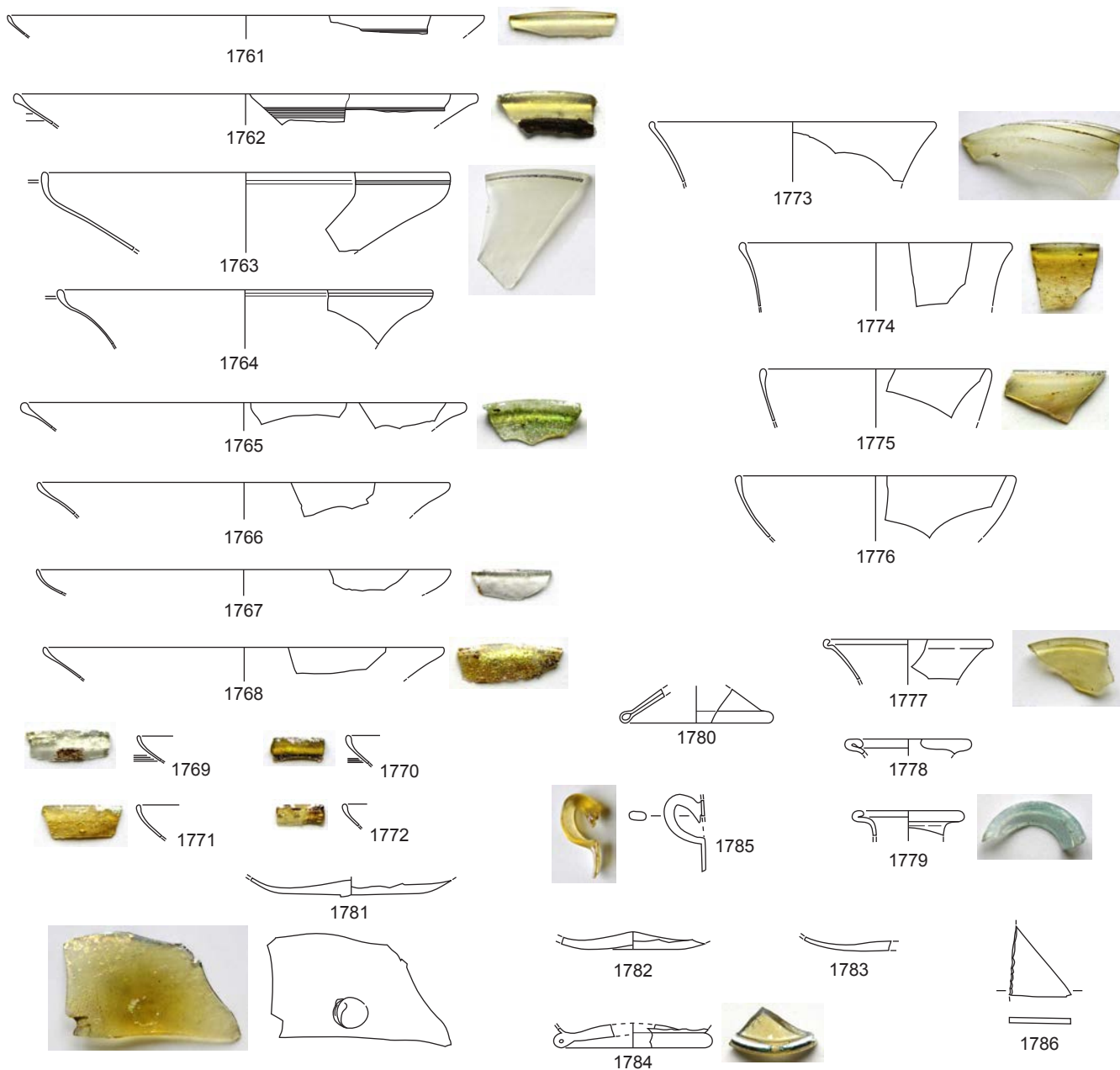

UE.15147

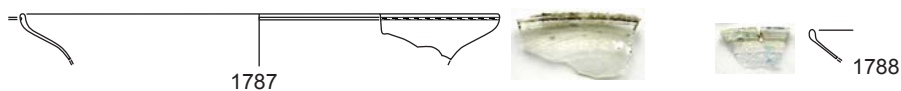

UE.15149

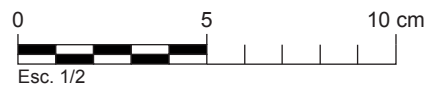
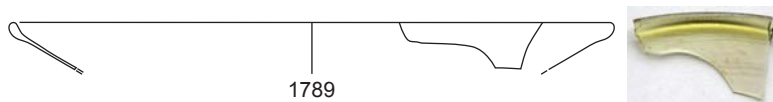

UE.15168

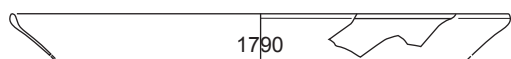

1790

UE.15173



1791



1792

UE.15182

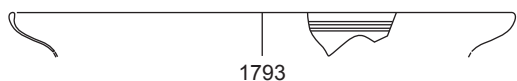

1793

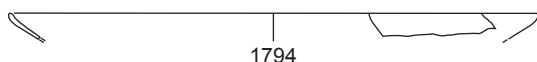

1794

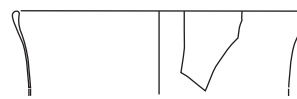

1795

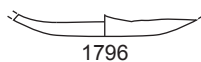

1796



1797

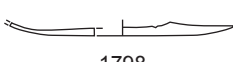

1798



1799

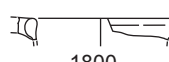

1800

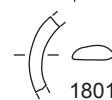

1801

UE.15186

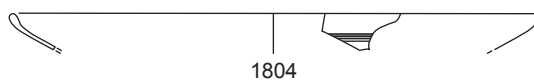

1804



1802



1803



1805



1806



1807

UE.15192



1808



1809



1810



UE.15195



1811



1813



1814

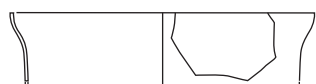

1812



1815



1816



1817

UE.15196

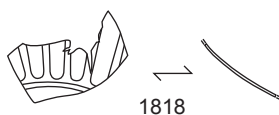

1818

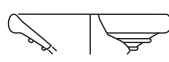

1819



1820

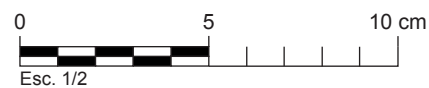



C/ Rectoria 16 (Terrassa)

UE.2

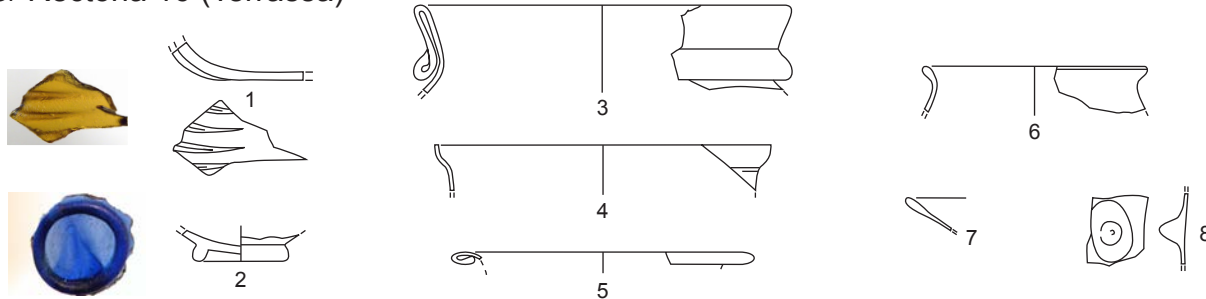

UE.10

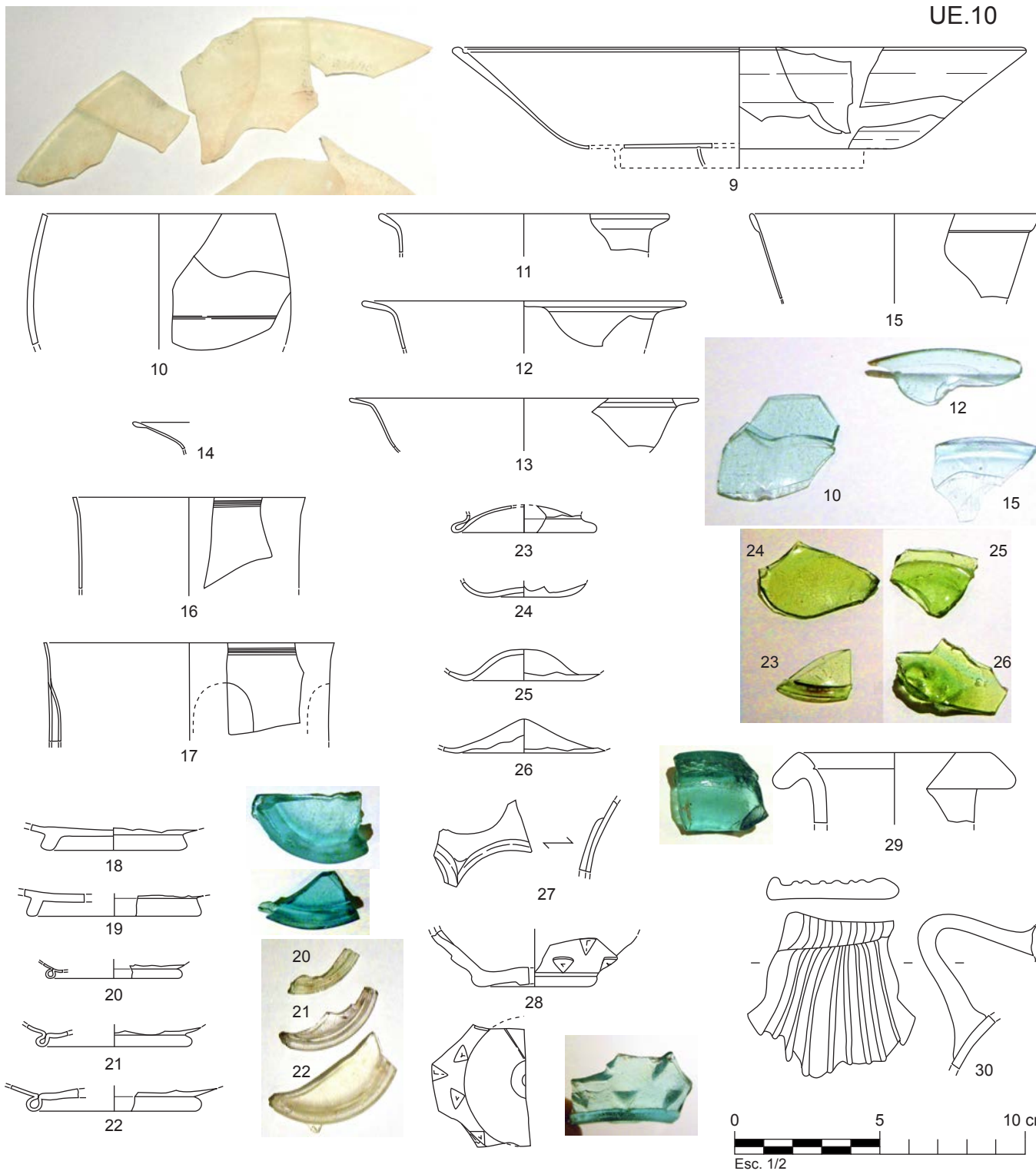

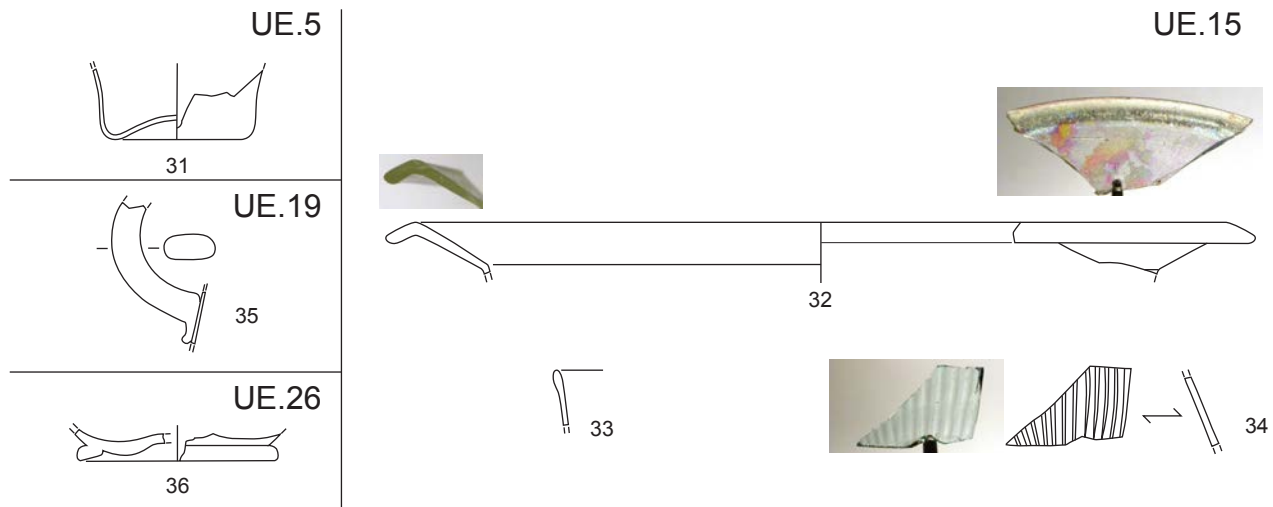

C/ Major de Sant Pere 15 (Terrassa)

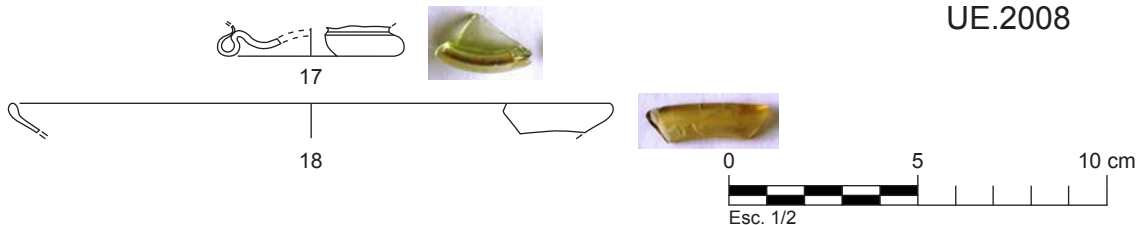
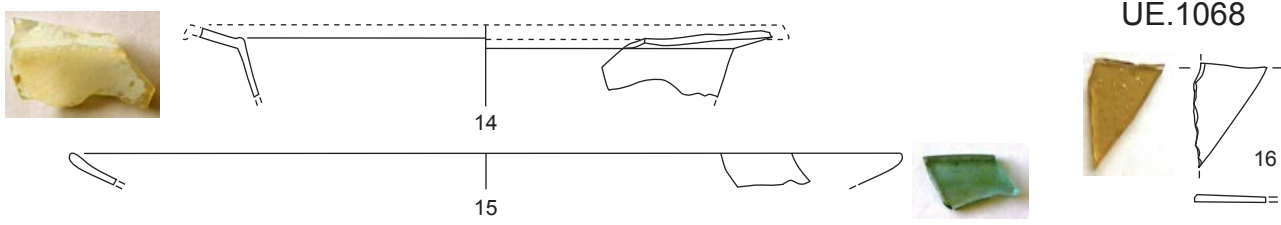
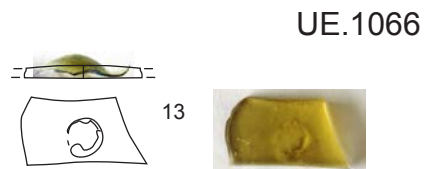
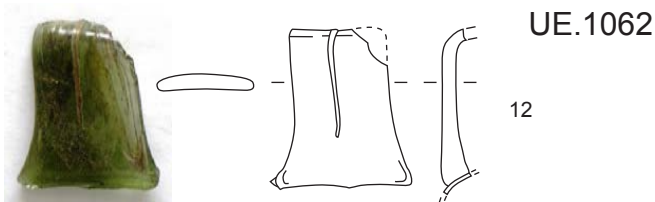
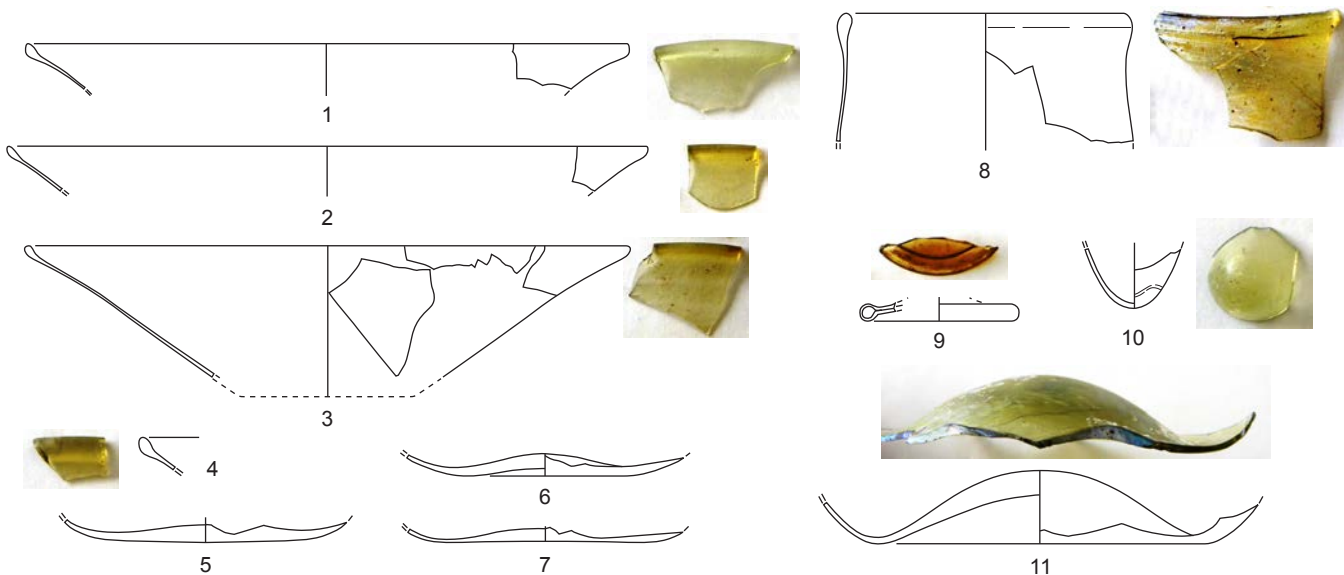

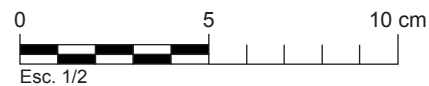
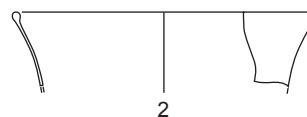
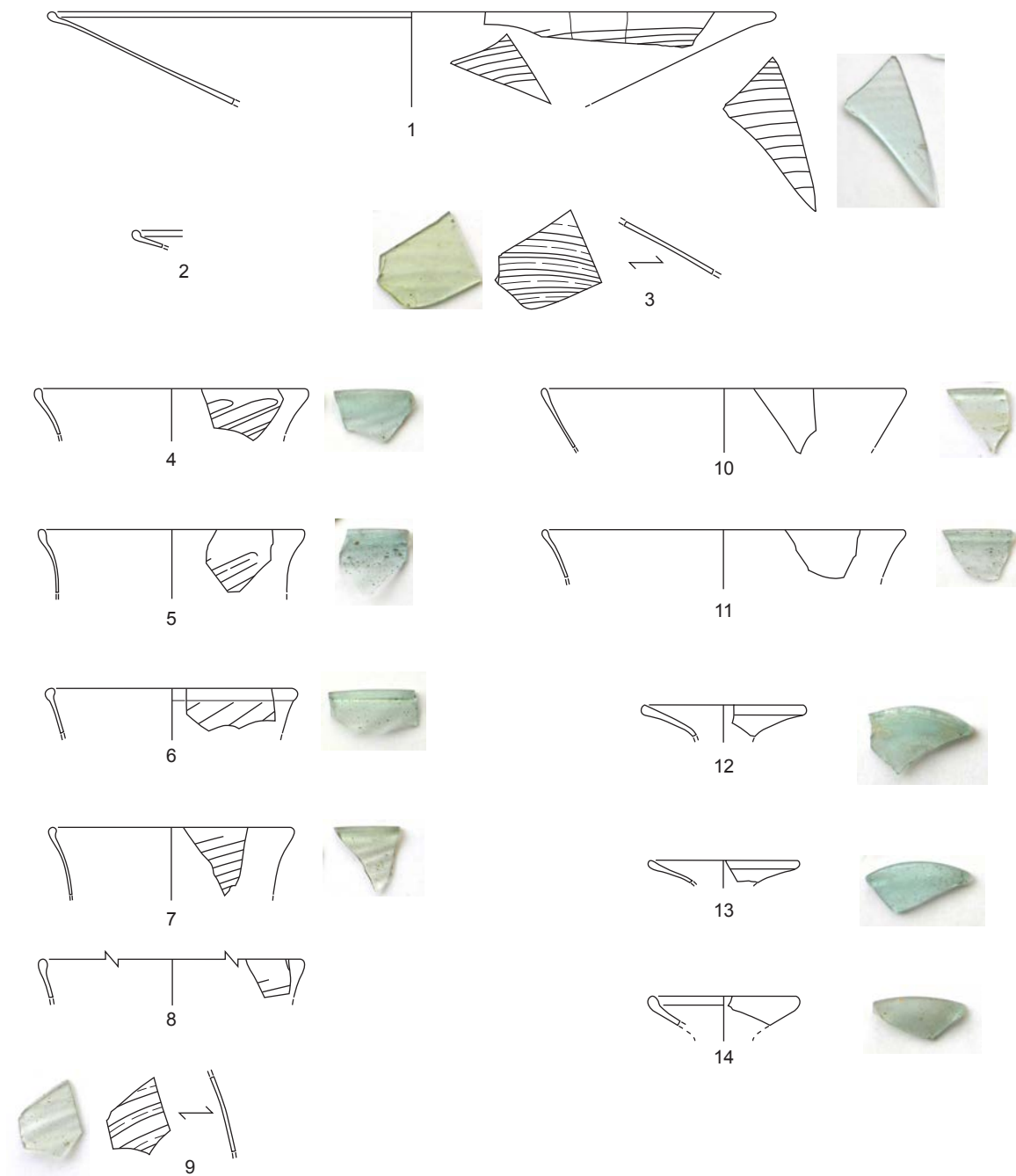

Sector 2. Balneum

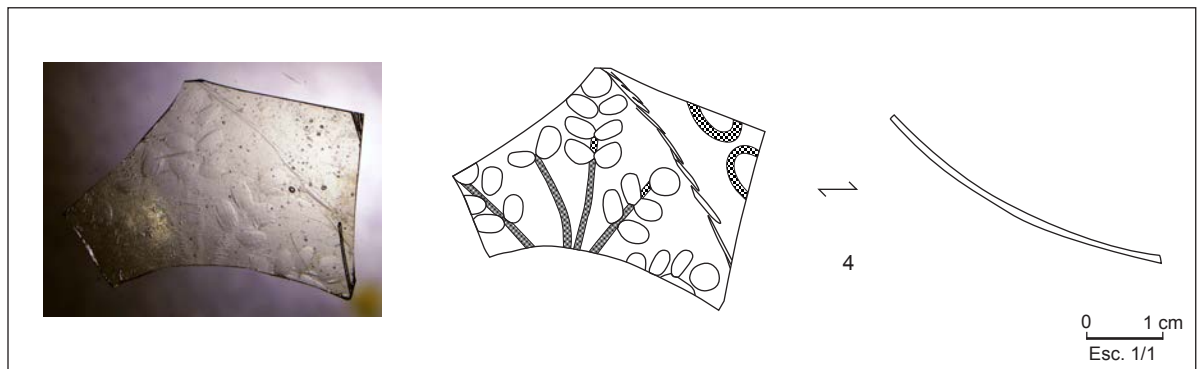
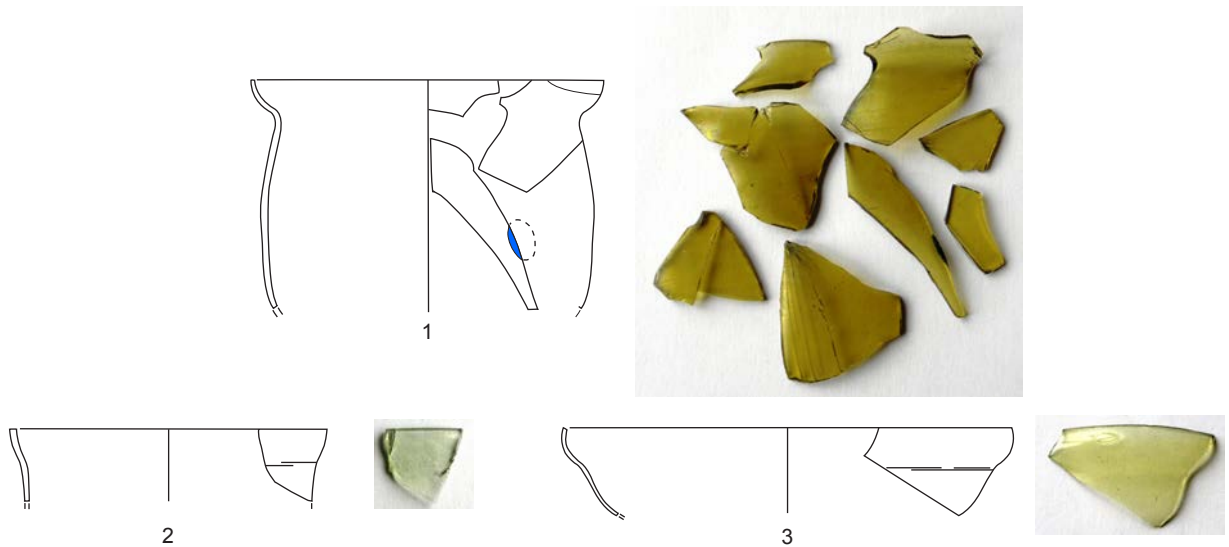

Sector 3. Pars rústica

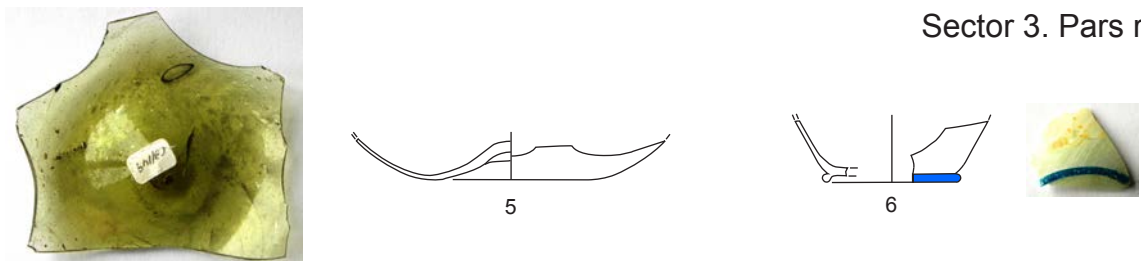

Sector 4. Sitges i pou

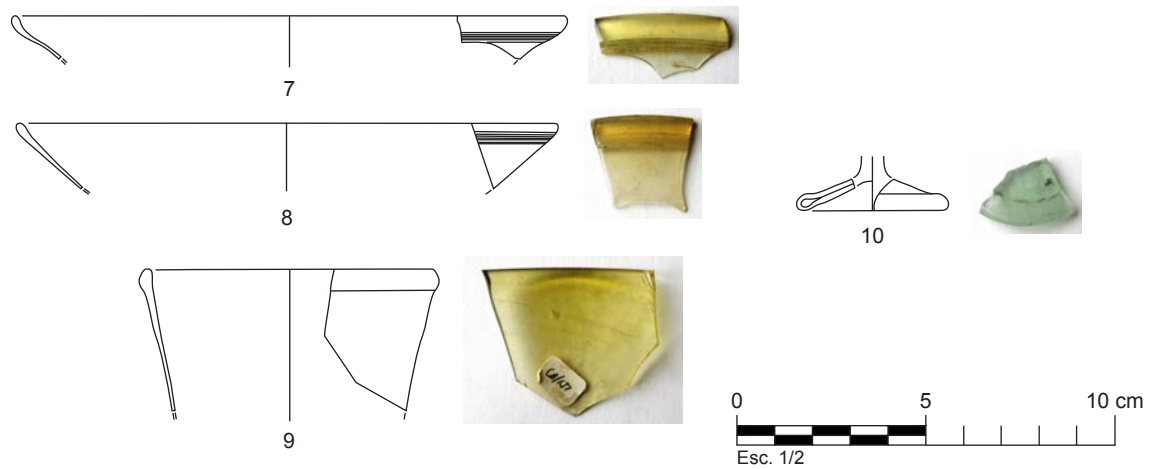

Vidre romà, sense context

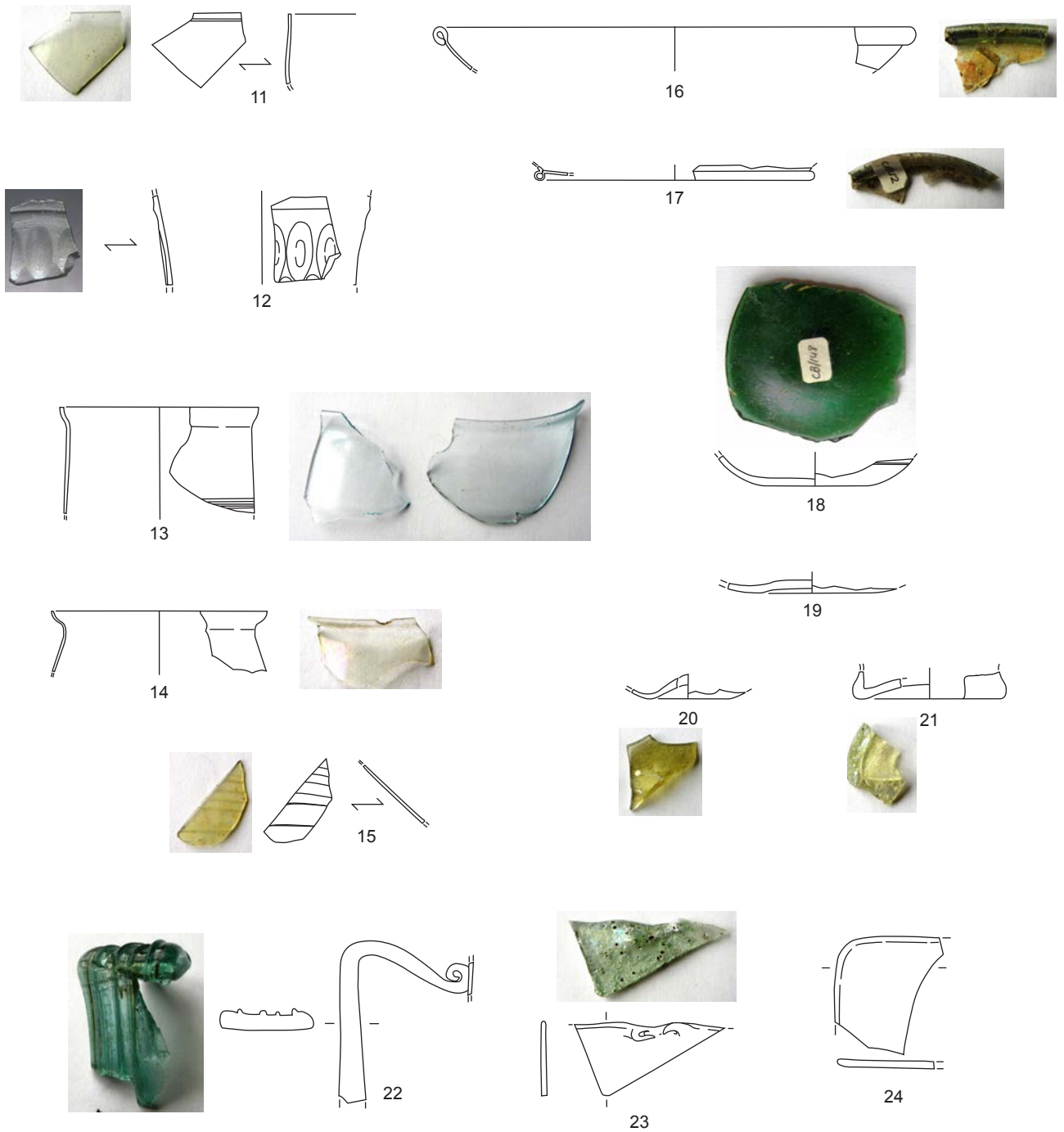

Vidre modern, sense context

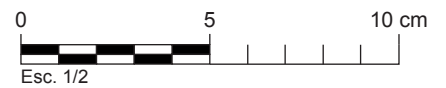

UE.45

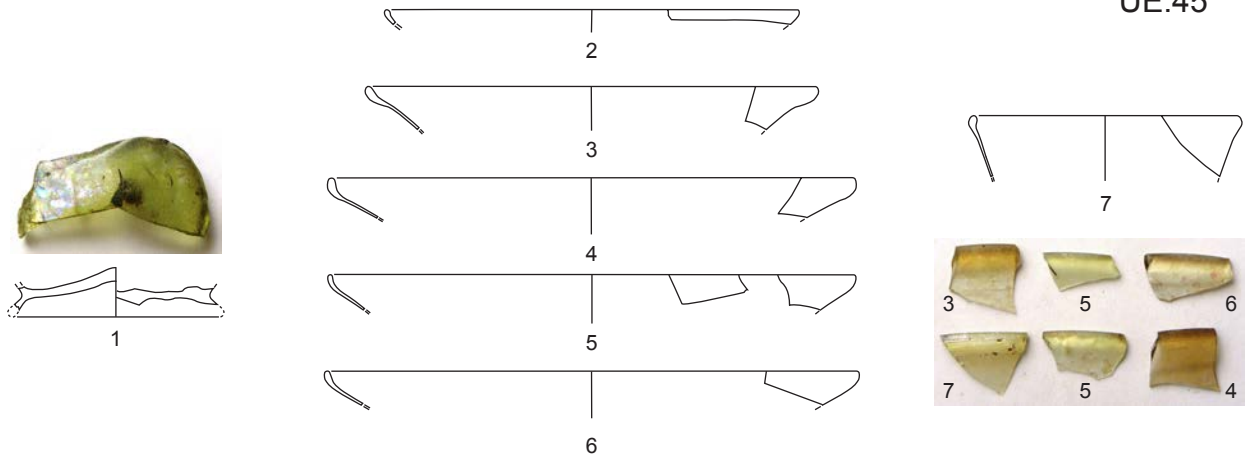

UE.83

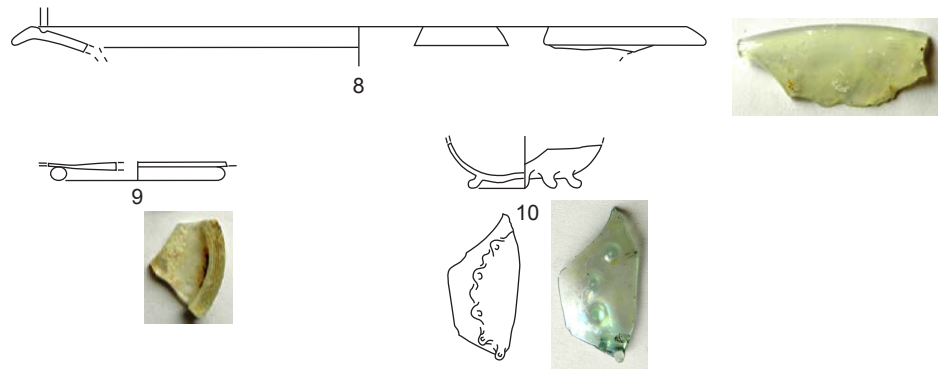

UE.85

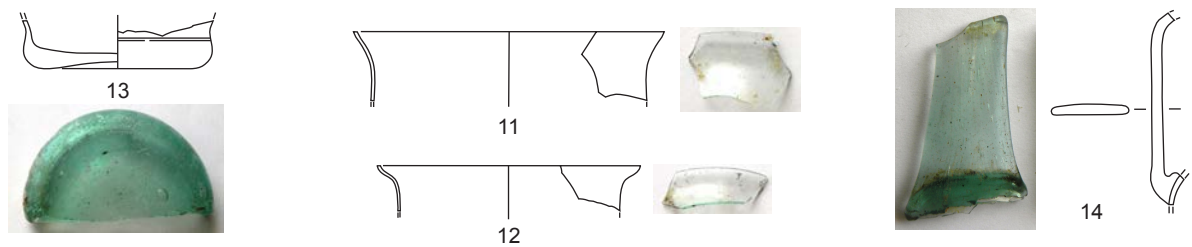

UE.87

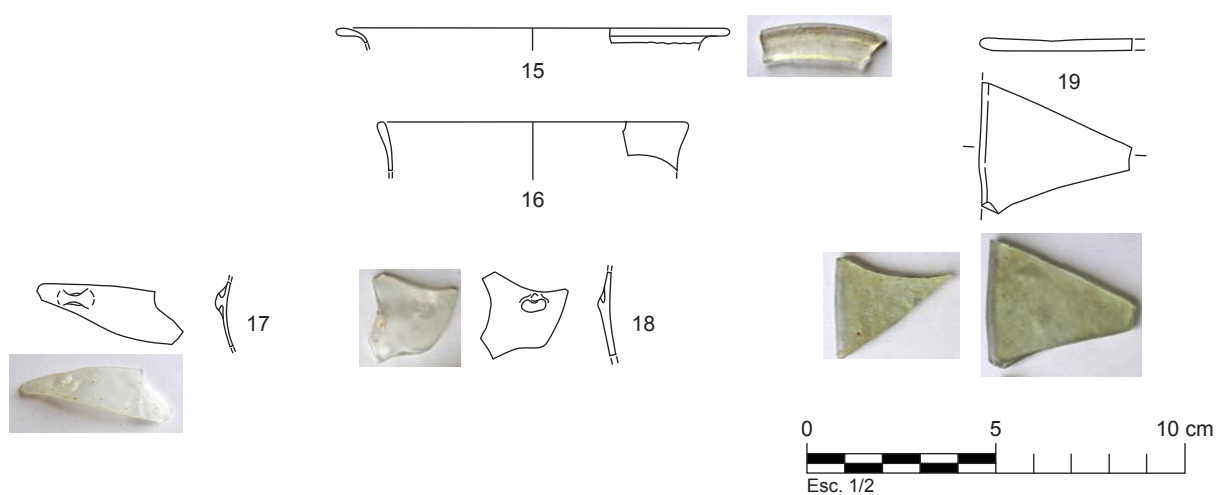

UE.100

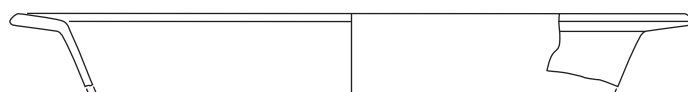

20



UE.104



21



23

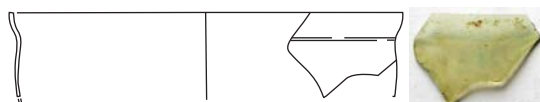

22

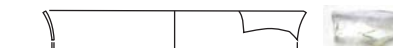

24

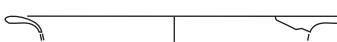

25



26



UE.138



27

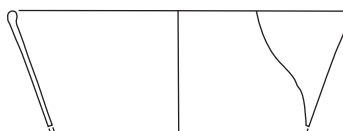

28



UE.148



29



31



32



30

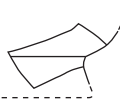

33



UE.149



34

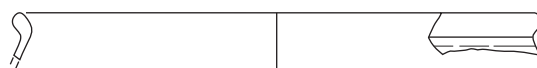

35



36



37

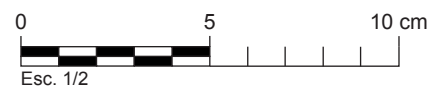

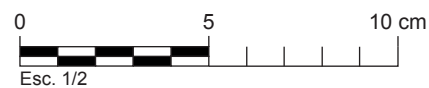
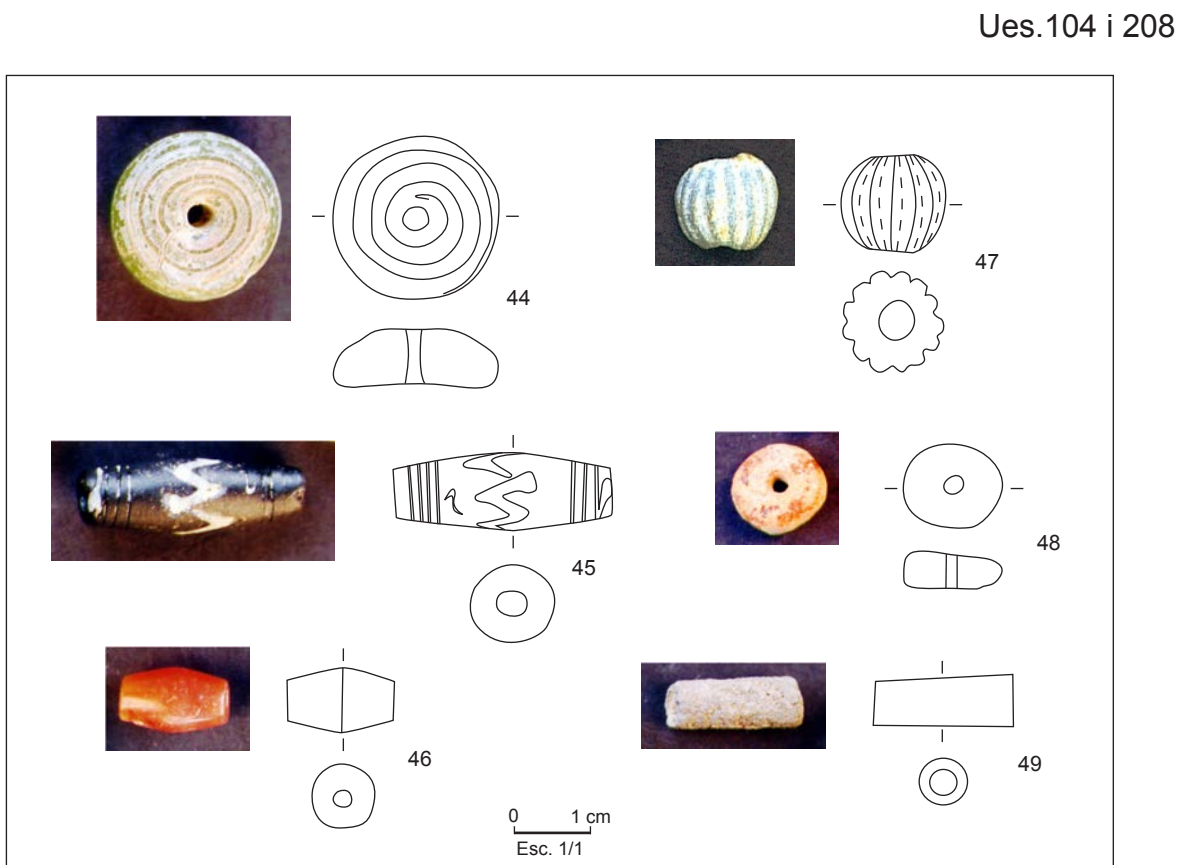
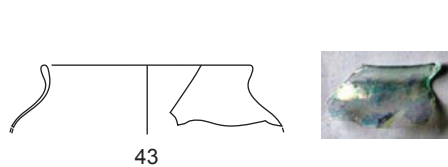
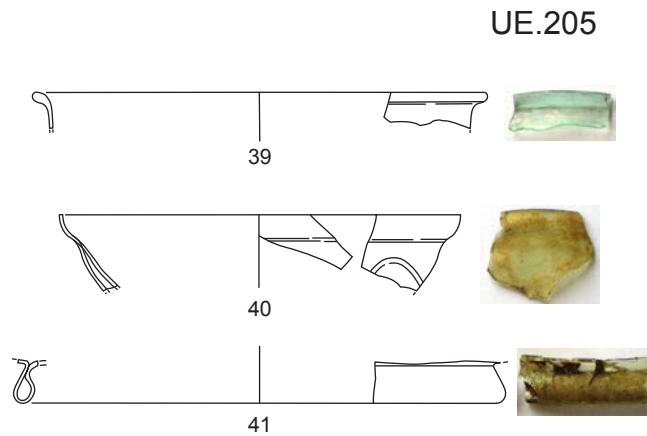
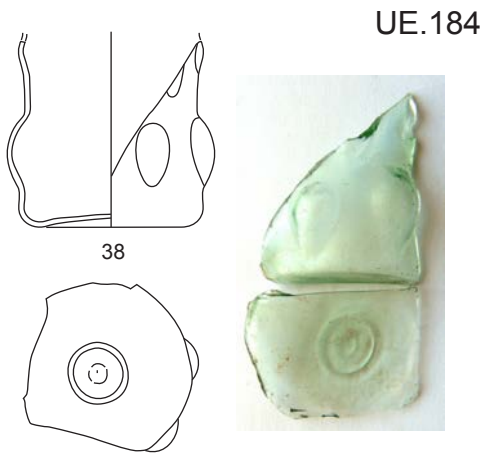



UE.1044

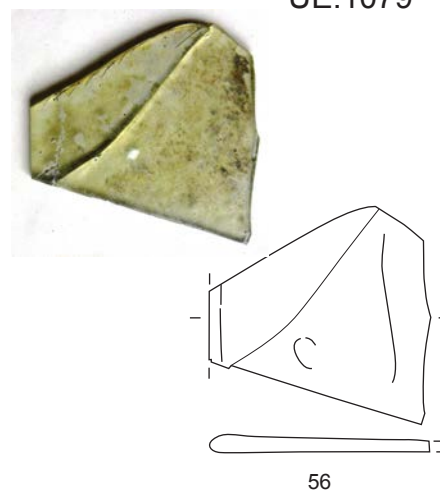
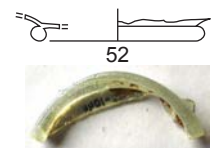
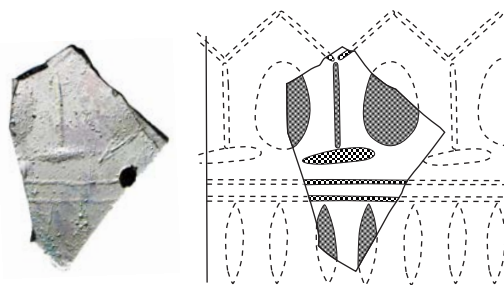
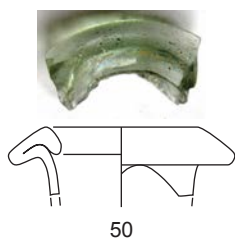

UE.1079

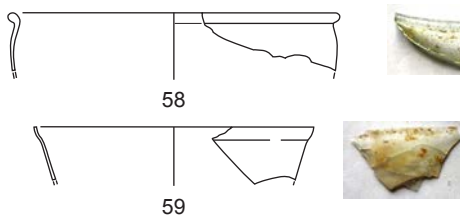
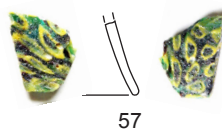

UE.1085

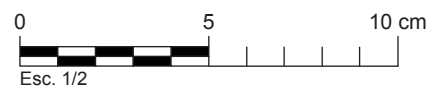
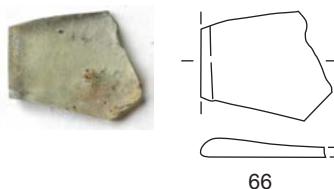
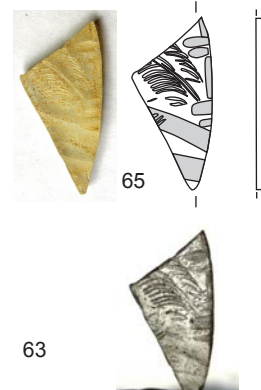
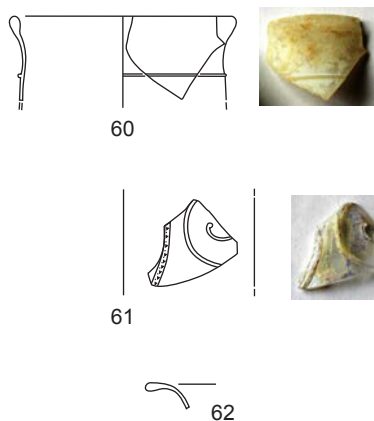
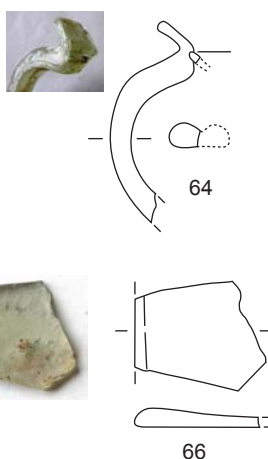

UE.1151

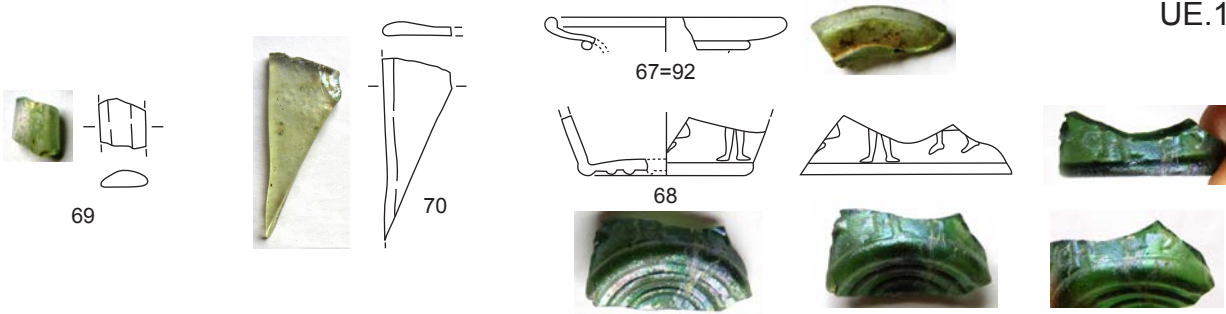

UE.1164

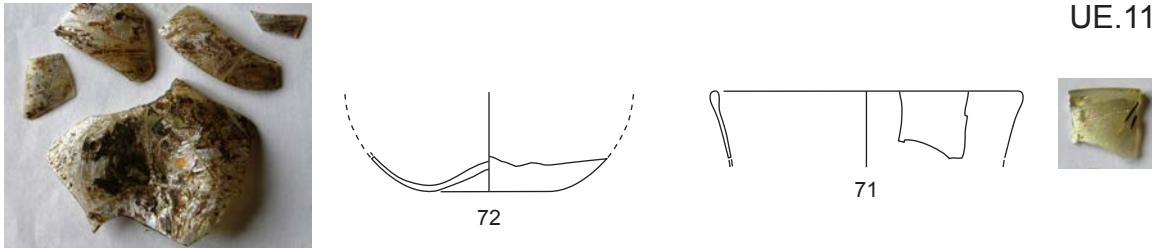

UE.1167

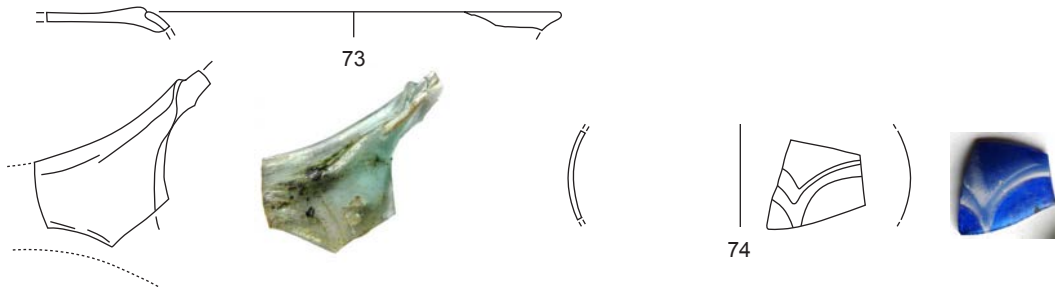

UE.1183

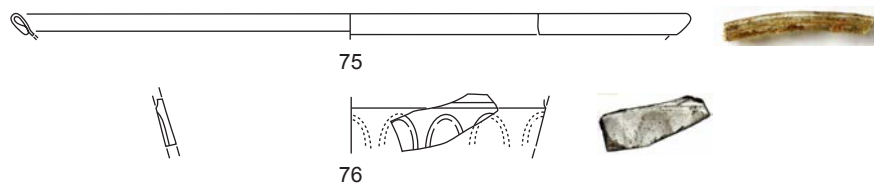

UE.1283

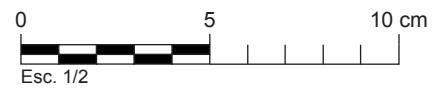
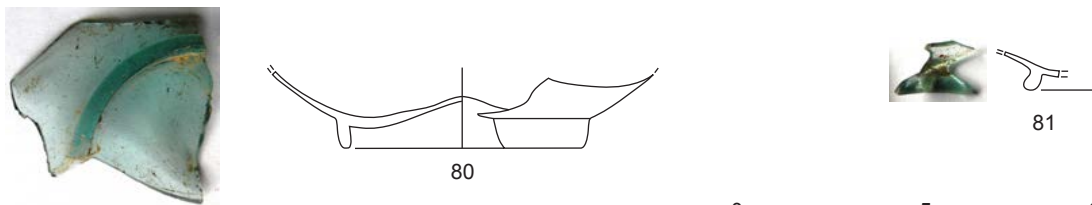
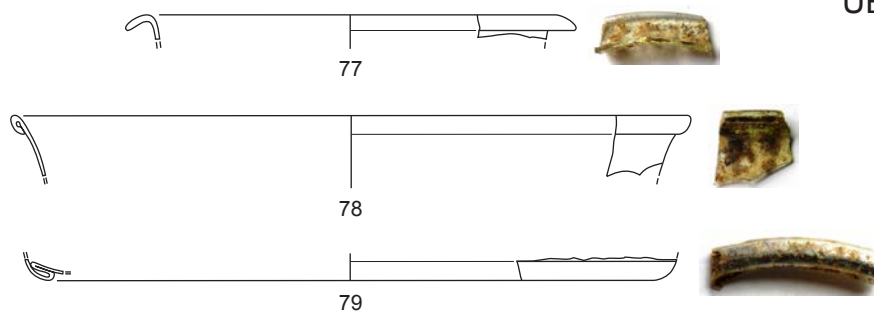

UE.1350

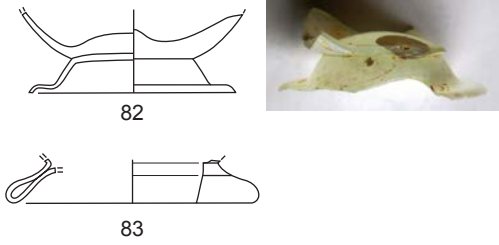

UE.1383



UE.1410

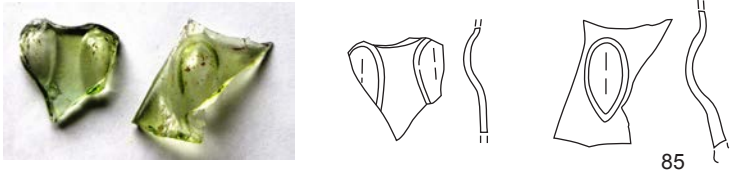

UE.1411

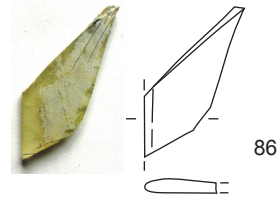

UE.1413

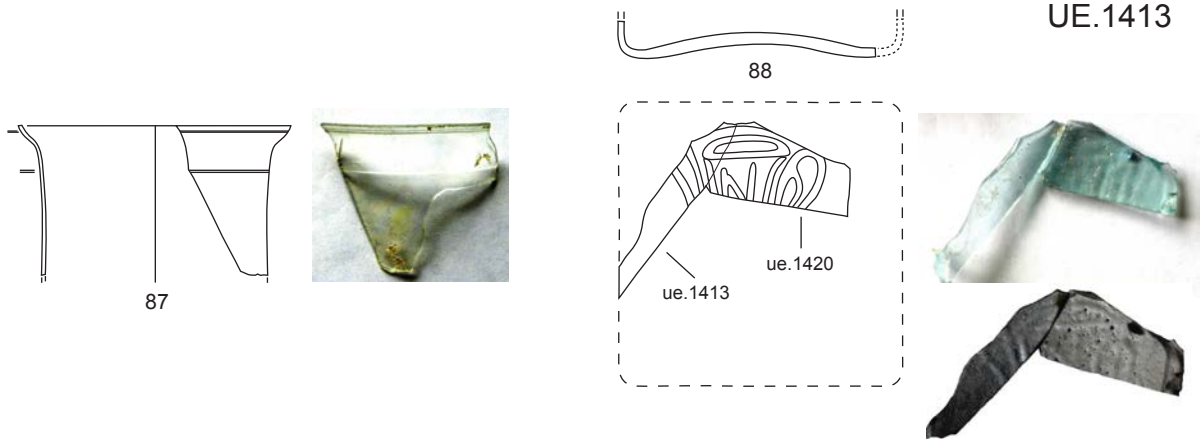

UE.1414



UE.1420

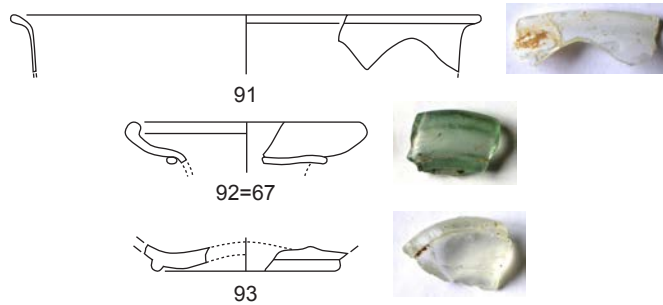

UE.1443

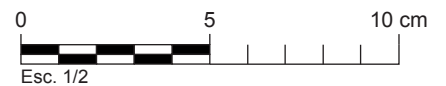
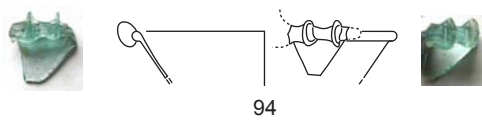

UE.1448

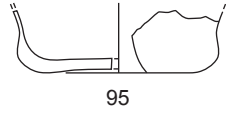

UE.1450

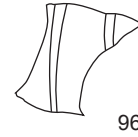

UE.1459

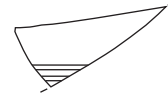
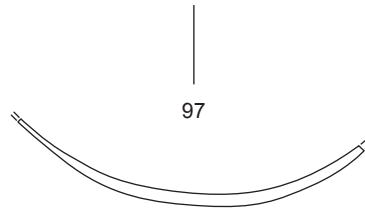
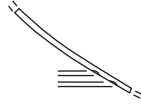

97

98

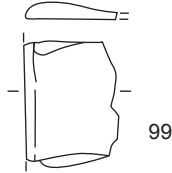
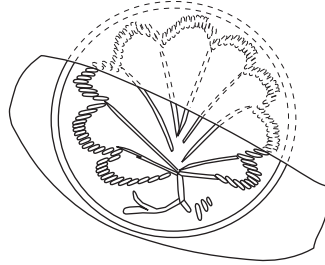

99

UE.1461

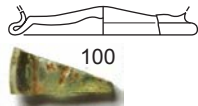

100



UE.1466



101



UE.1477

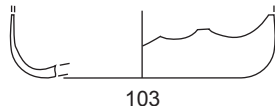

103



104



105

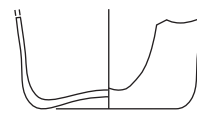

102



UE.1481

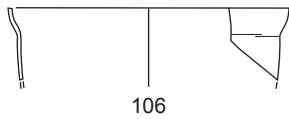

106

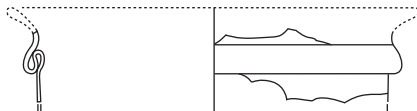

107



UE.1493

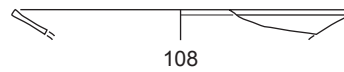

108



UE.1499

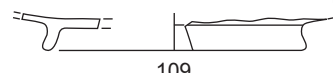

109

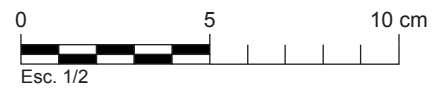

UE.1525

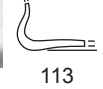
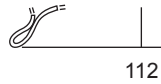
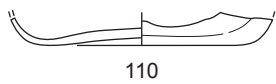

UE.1530

UE.1546

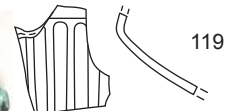
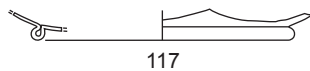
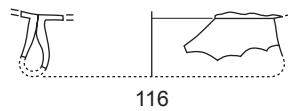
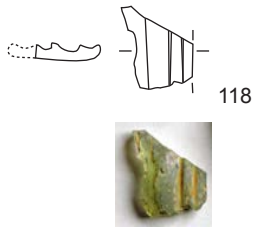
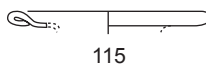

UE.1552

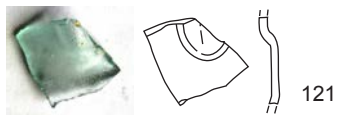
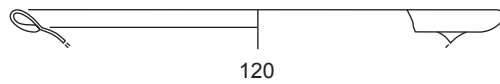

UE.1562

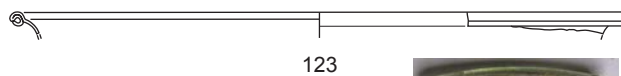

UE.1565

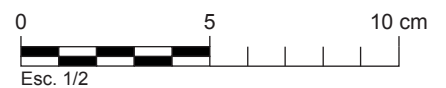
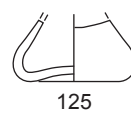
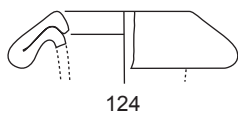

UE.1582

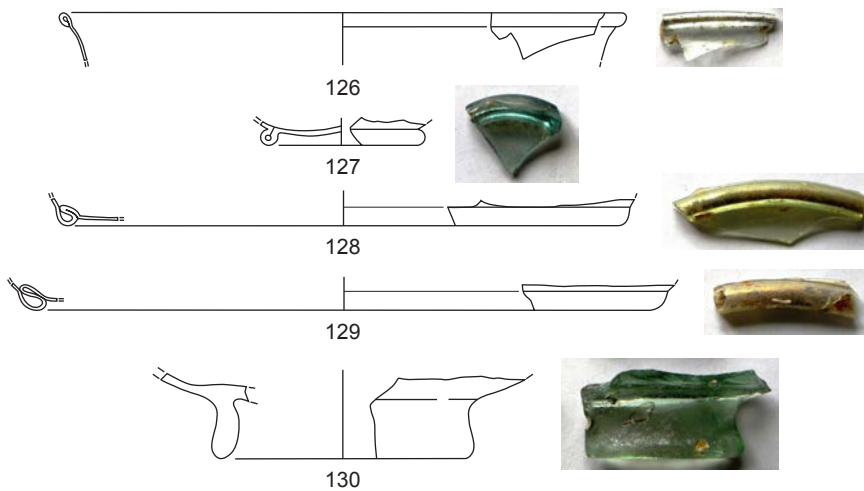

UE.1585



UE.1586

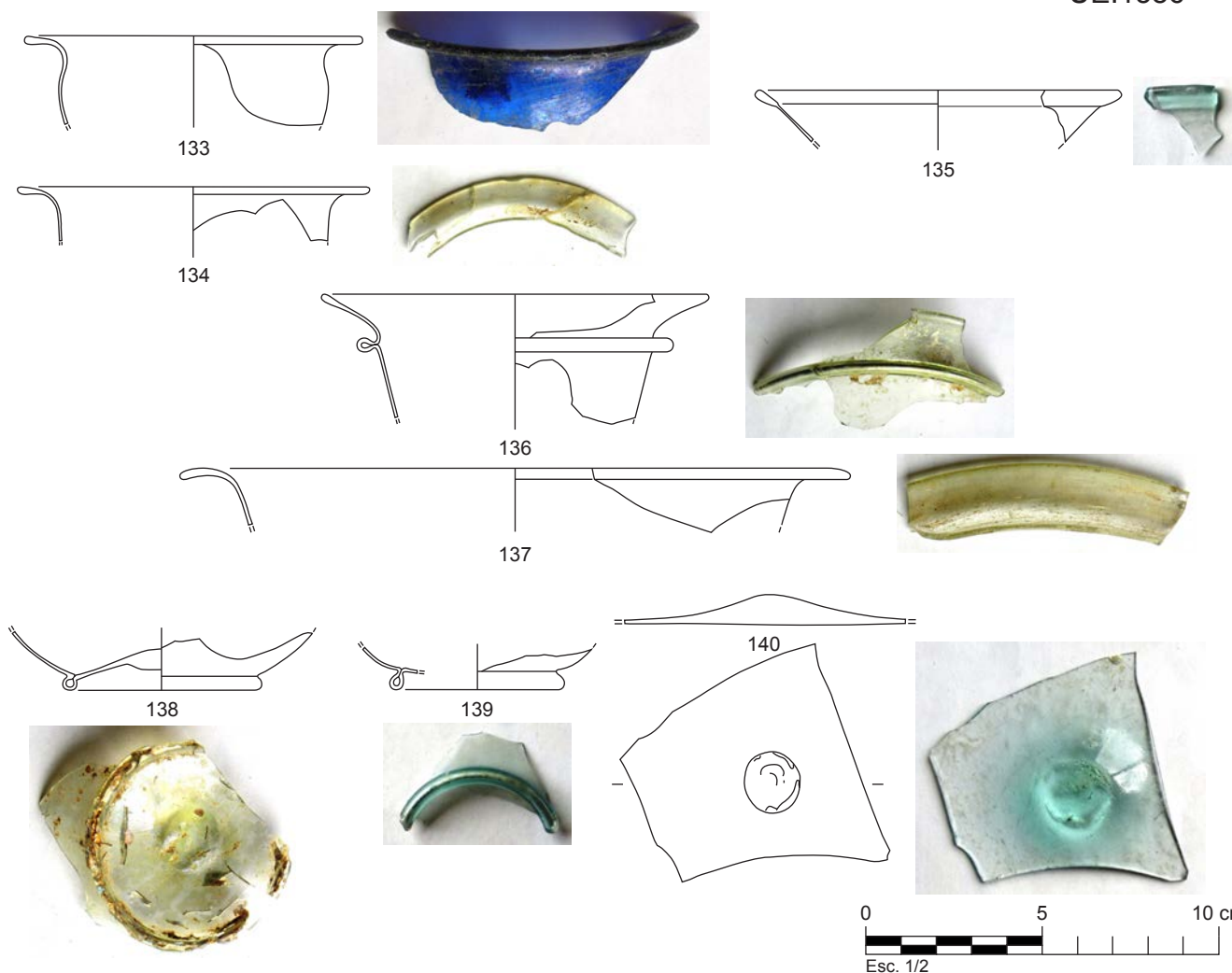

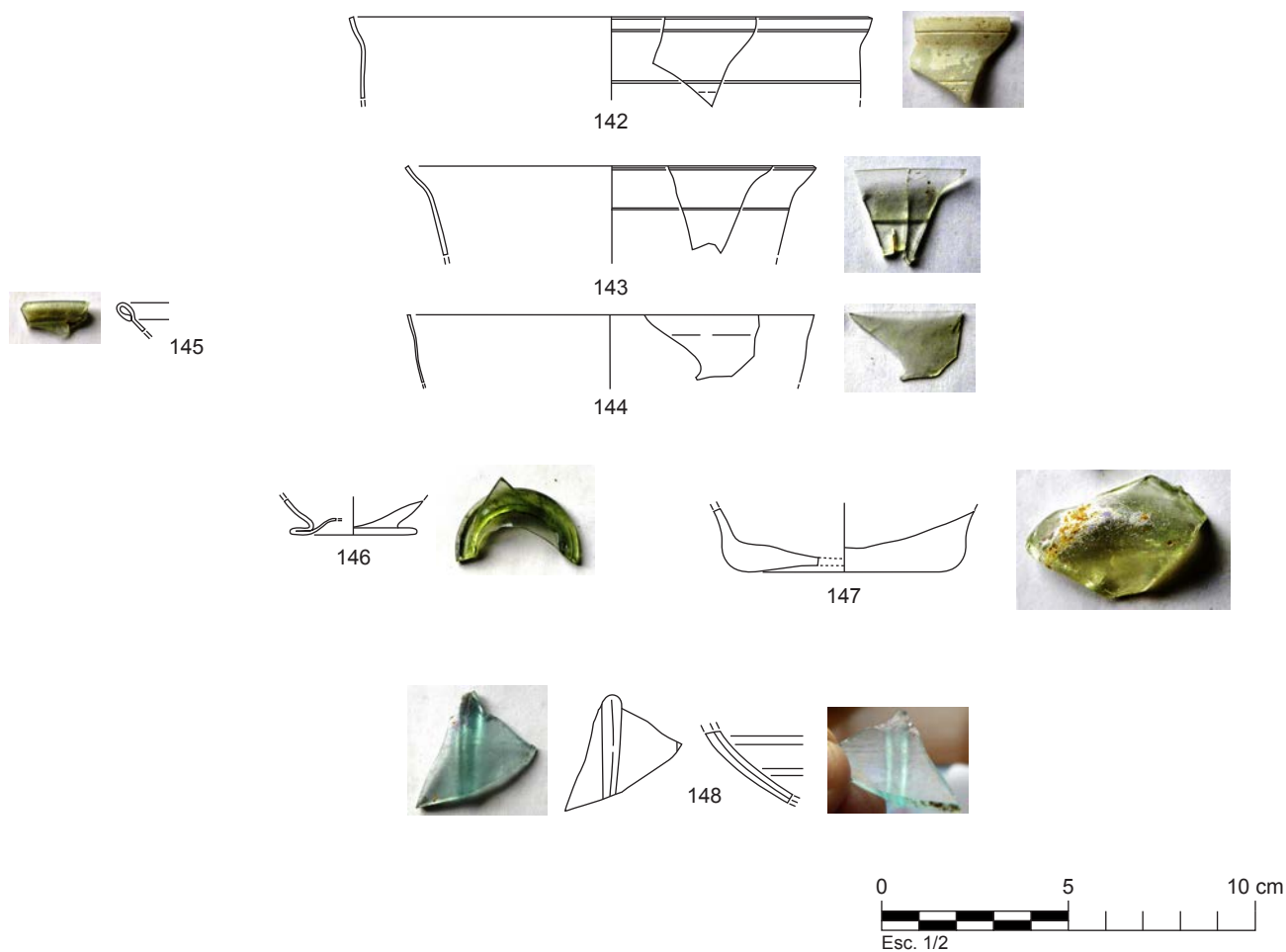
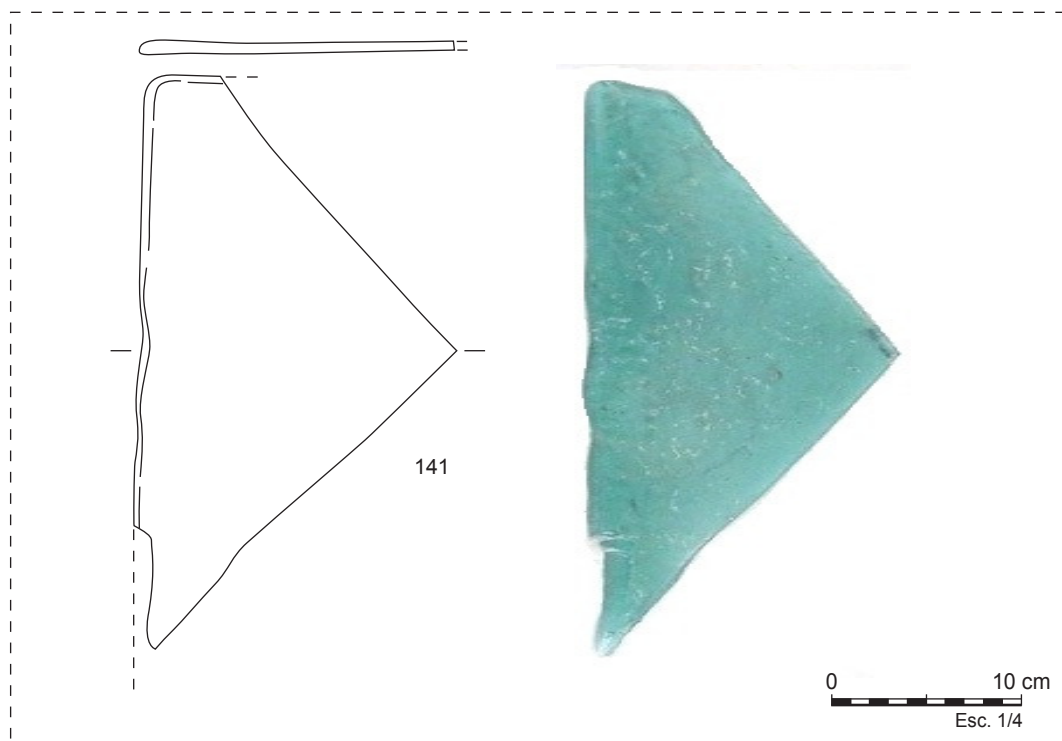

UE.1594

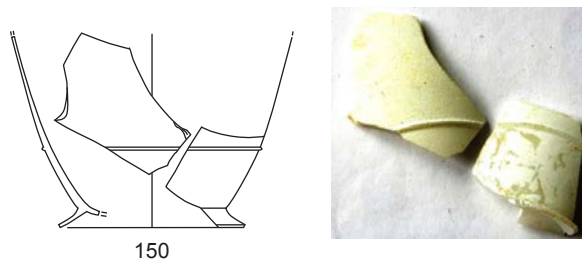
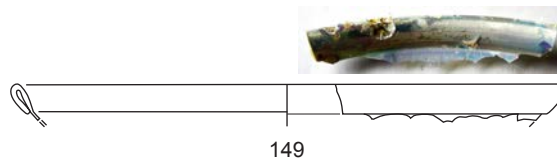

UE.1597

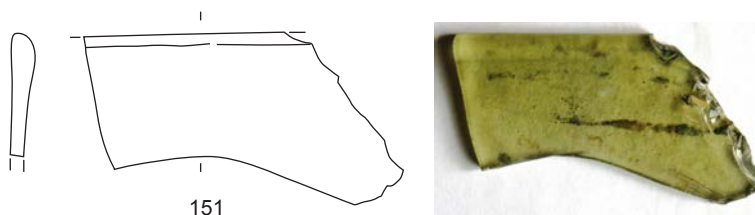

UE.1670

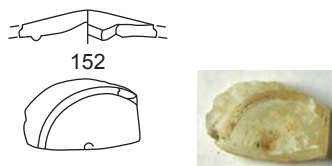

Can Fonollet (Terrassa)

UE.8

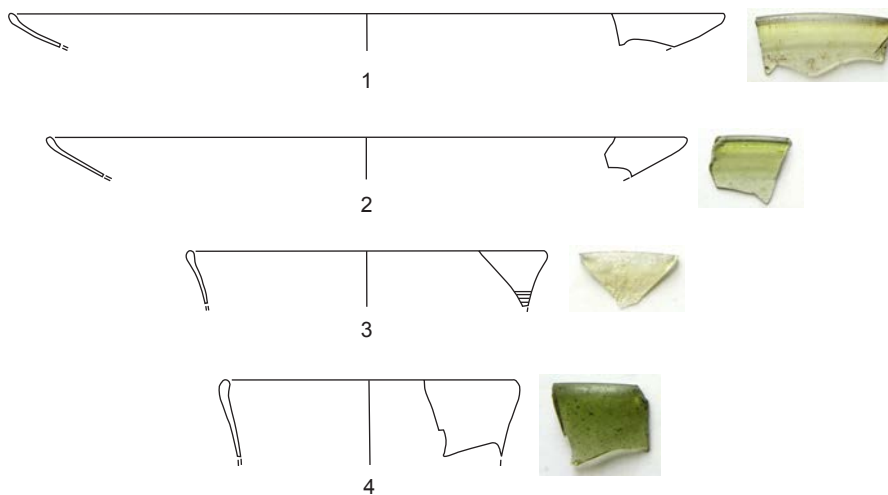

UE.11

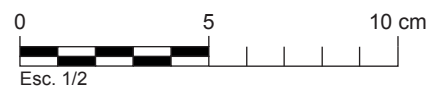



UE.229

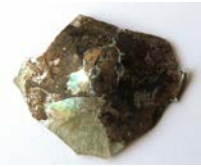

UE.347

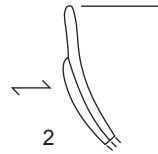

UE.411

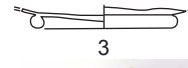

UE.456

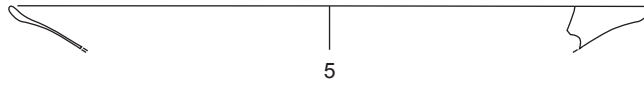

UE.466

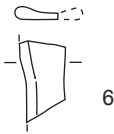

UE.469

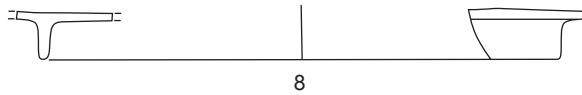
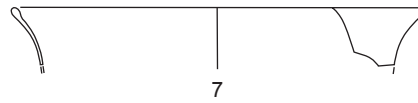

UE.490

UE.545

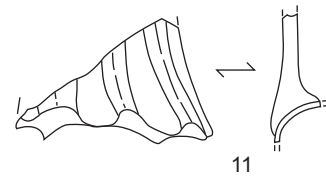
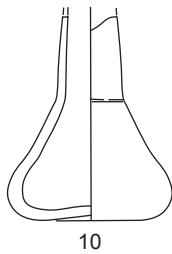
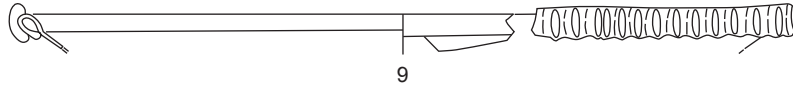

UE.542

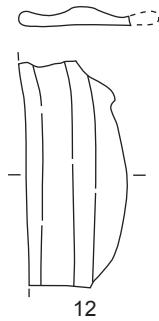

UE.547

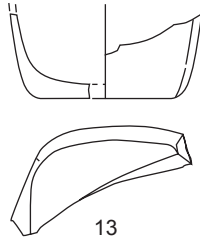

UE.579

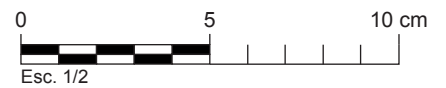

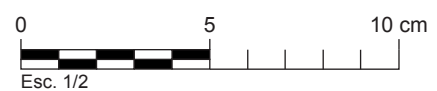
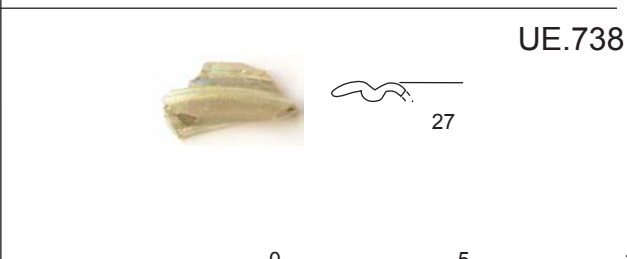
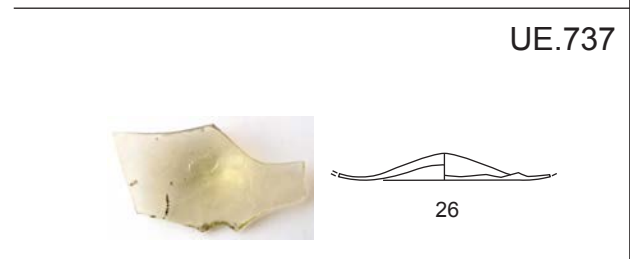
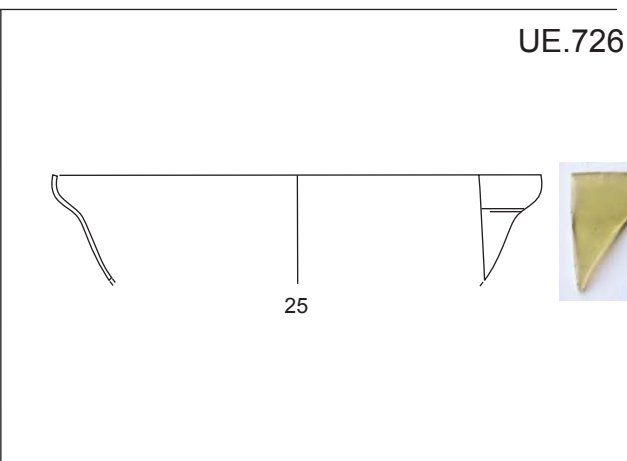
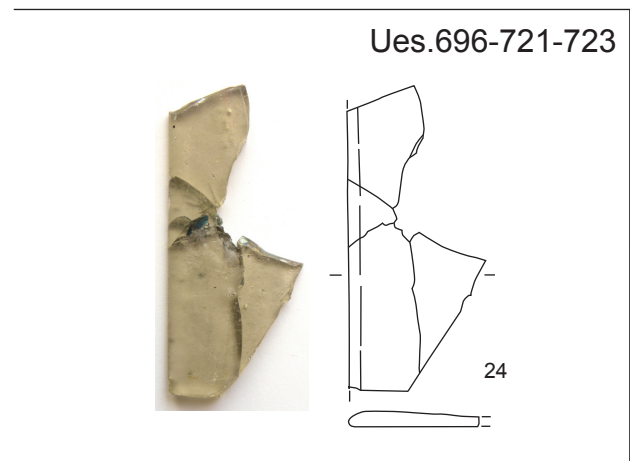
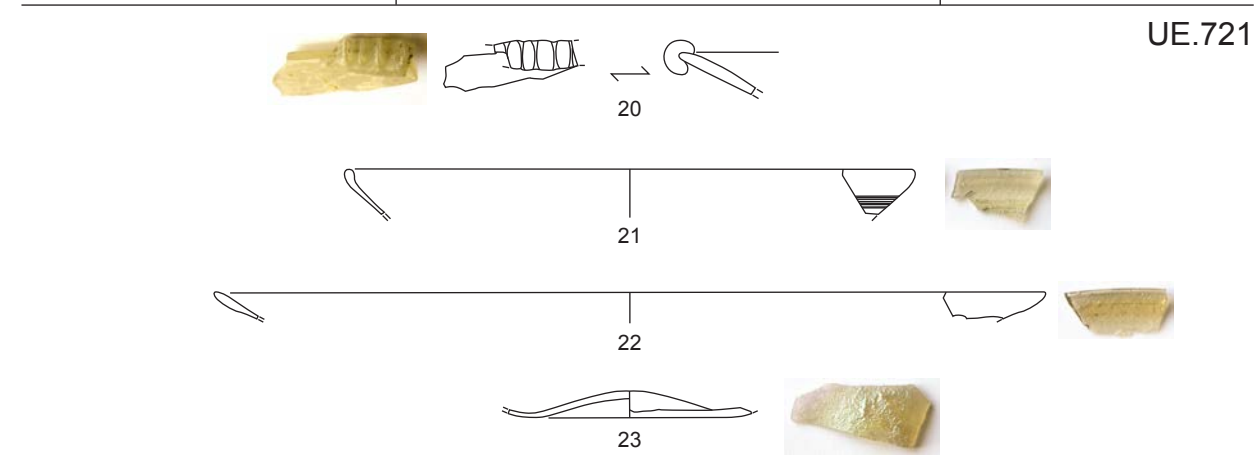
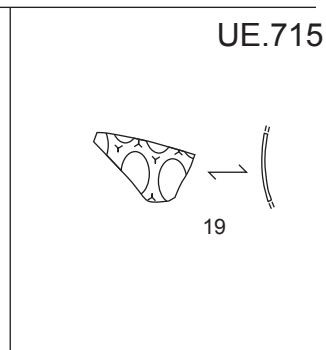
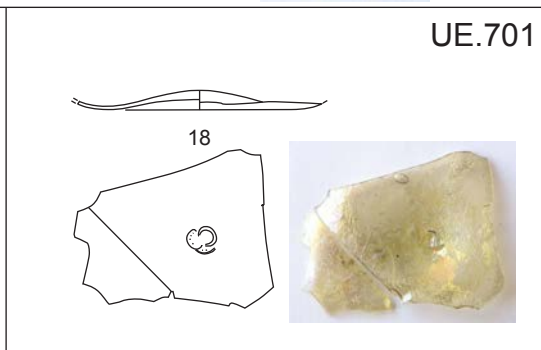
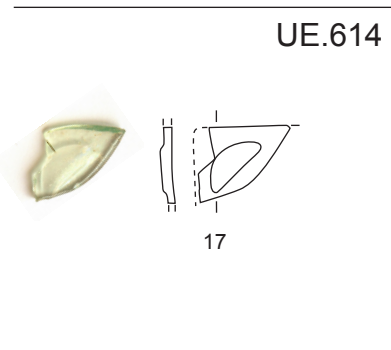
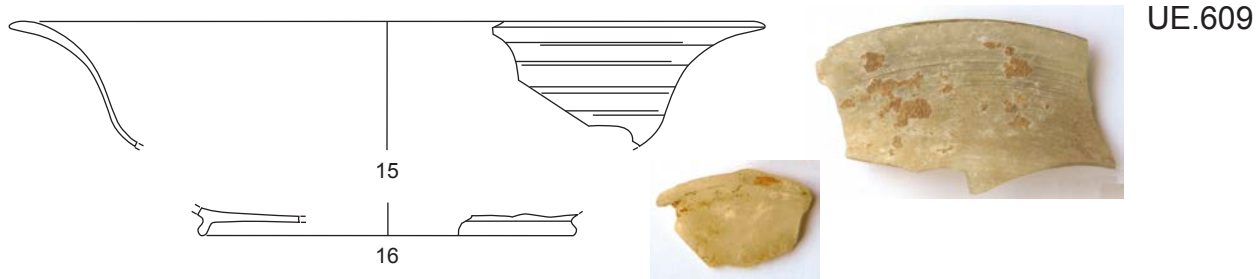

UE.61



UE.138

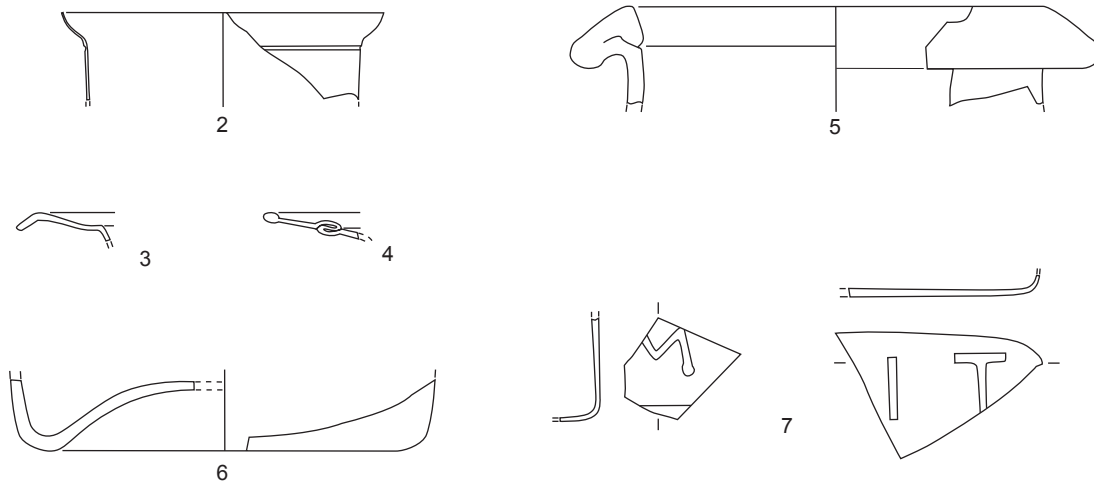

UE.140

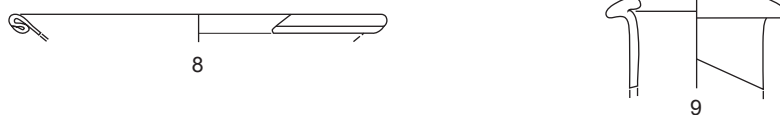

UE.163



UE.641

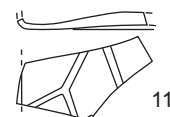

UE.731

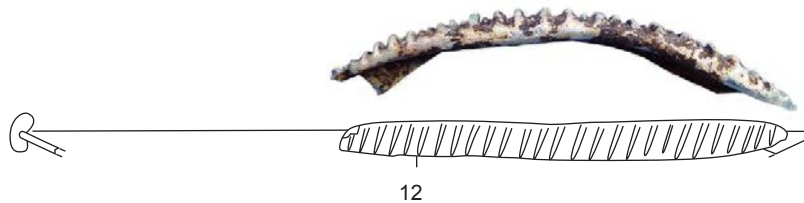

UE.747

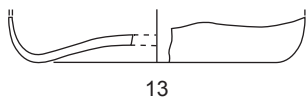

UE.758



UE.831

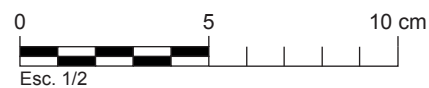
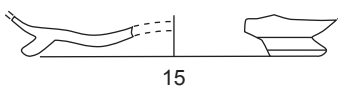

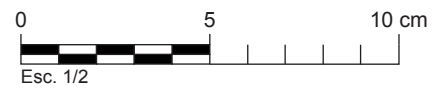
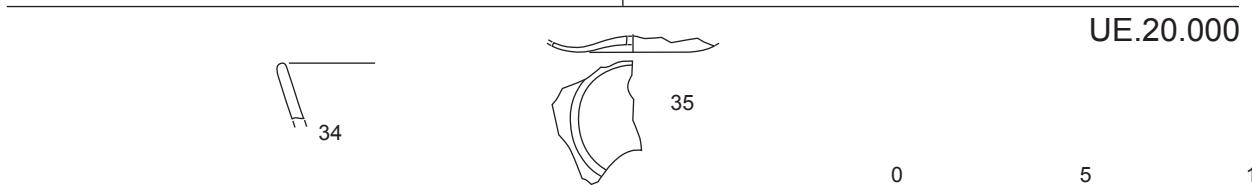
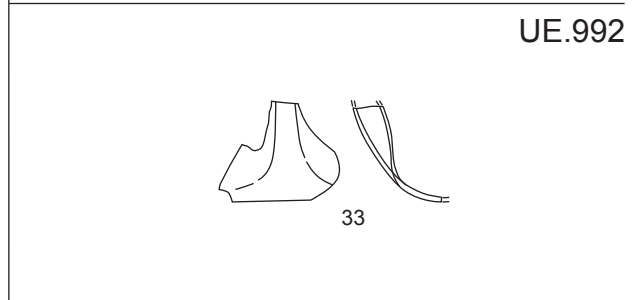
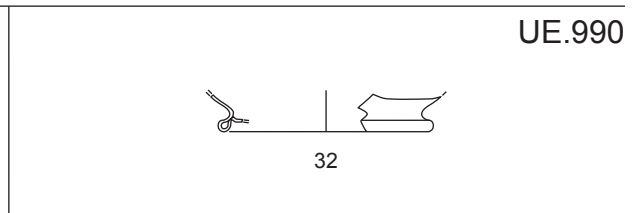
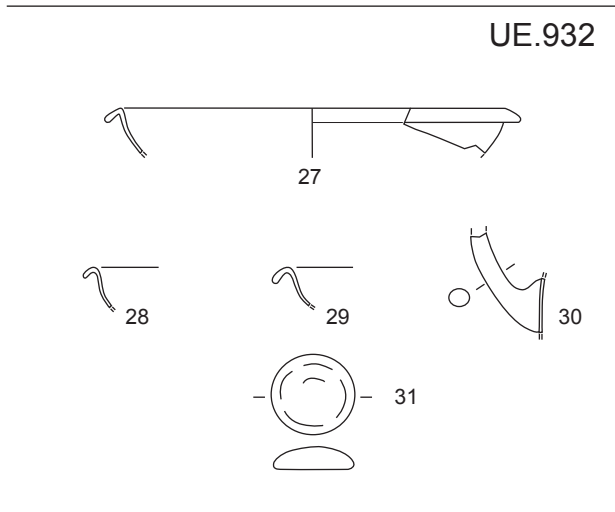
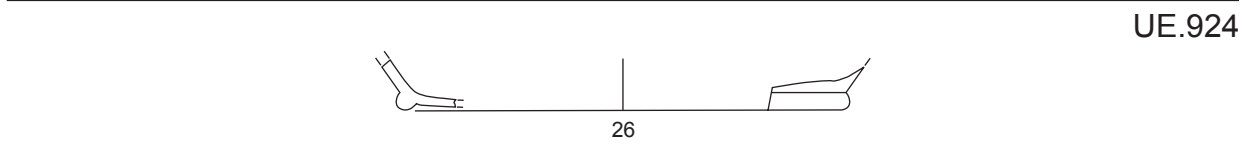
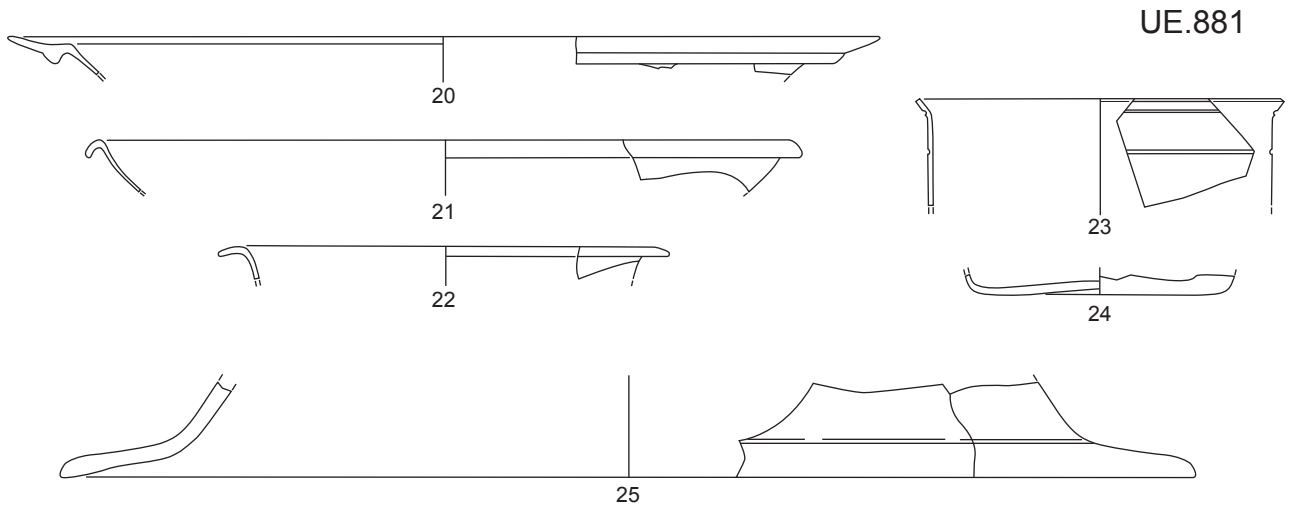
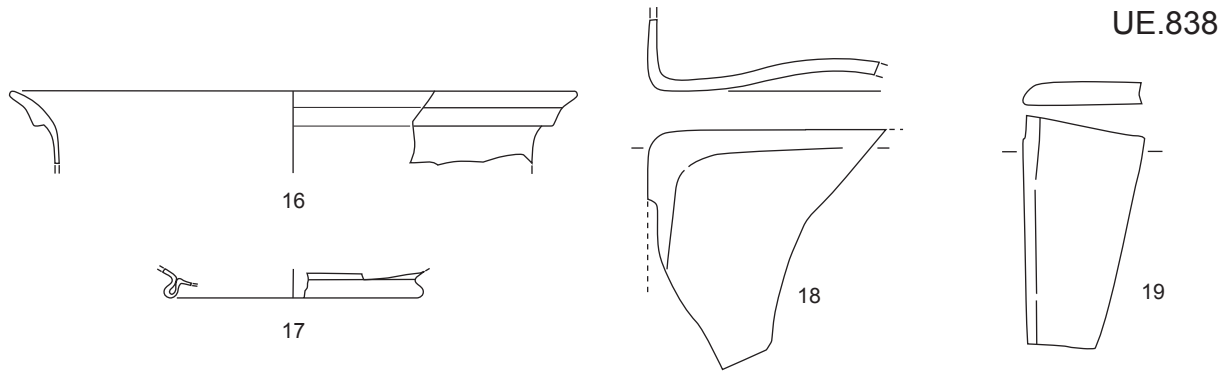

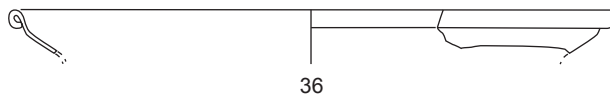

UE.221

36

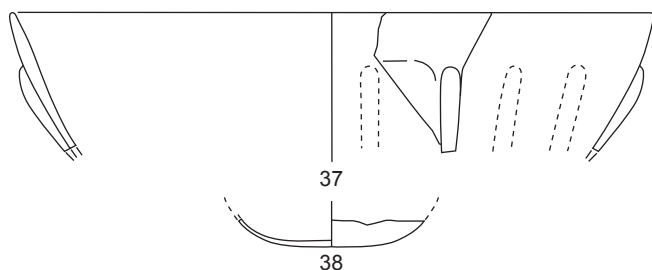

UE.286

UE.414

37

38

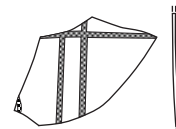

39

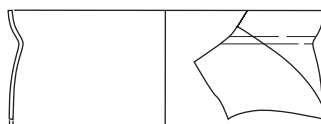

40



41

UE.435



42

43

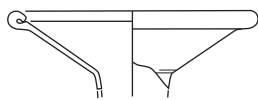

44

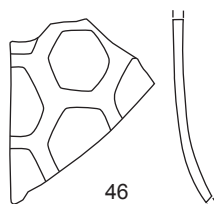

46



47

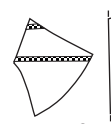

48

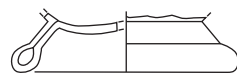

45

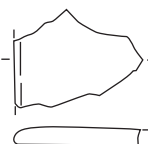

49

UE.745

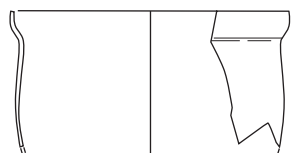

50



51

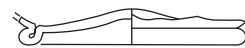

52

UE.763



53

UE.840



54

UE.855

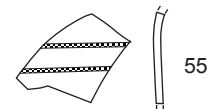

55



56

UE.856

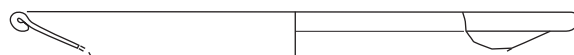

57

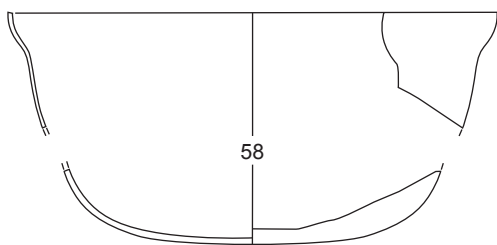

UE.883

58

59

UE.903

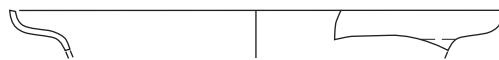

60

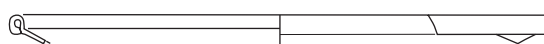

61

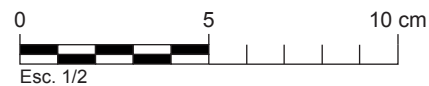

UE.1046

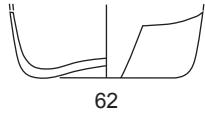

UE.1085

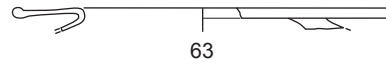

UE.1106

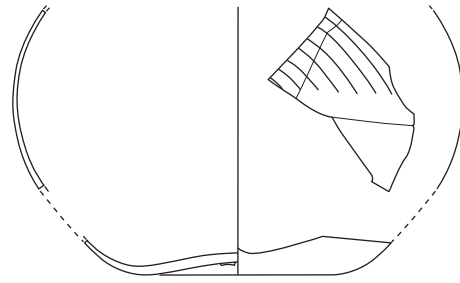
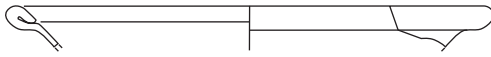

UE.1154

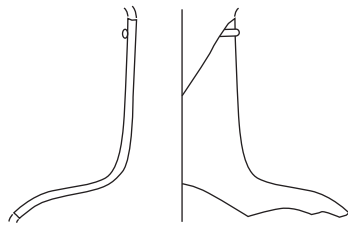

UE.1191

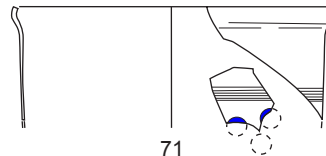
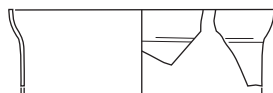

Sense referència

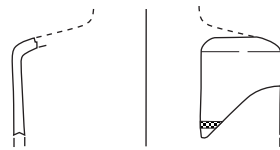

UF-4-8-15

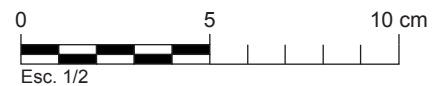
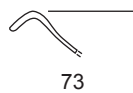

UE.25



74

UE.128

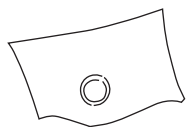
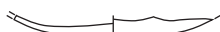

75

UE.238



76

UE.443

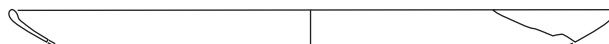

77

UE.445



78

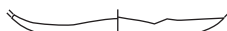

79

UE.563

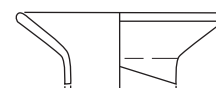

80

UE.569



81

UE.586



82

UE.644

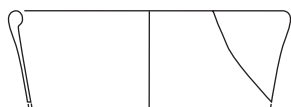

83

UE.647



84

UE.723

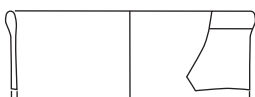

85

UE.733

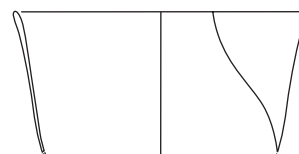

86

UE.743



87



90



88



89



91

UE.783



92



92 bis

UE.819



93

UE.861



94

UE.989



95

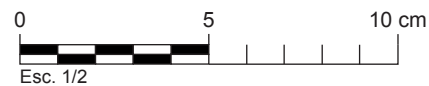

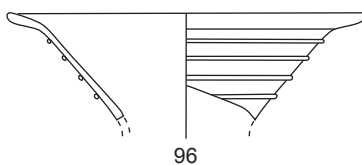

96

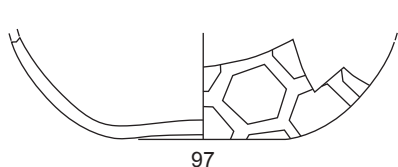

97

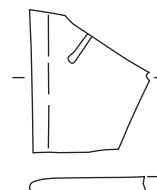

98



99

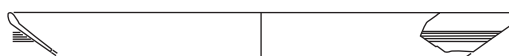

100



101

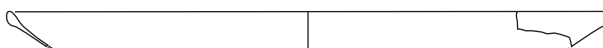

102



103



104



105



106



107



108



109



110

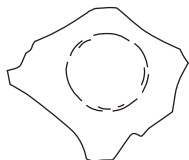

Sense referència

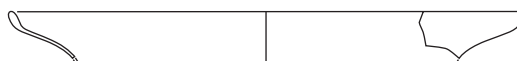

111

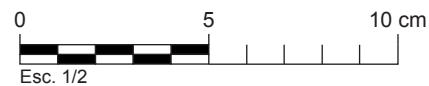





UE.16

112

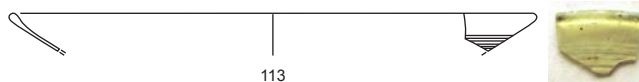

UE.44

113



UE.52

114

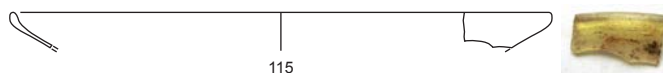

UE.55

115



UE.80



116

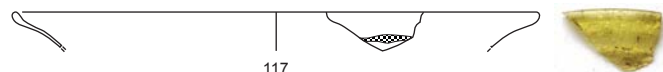

UE.84

117



120



118



119

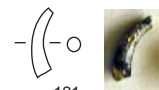

121

UE.86



124

Vidre en brut

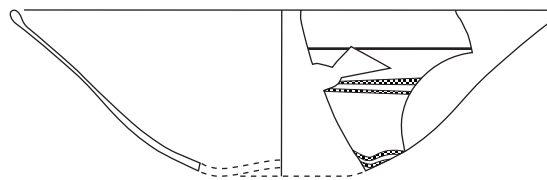

122



123

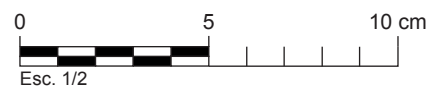

UE.2

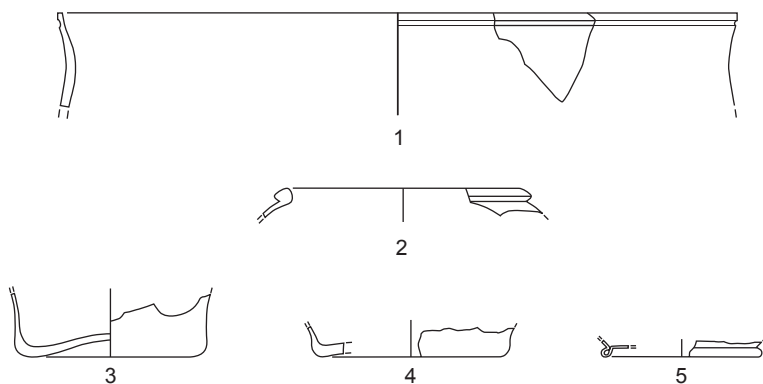

UE.3

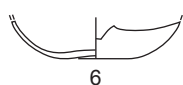

UE.7

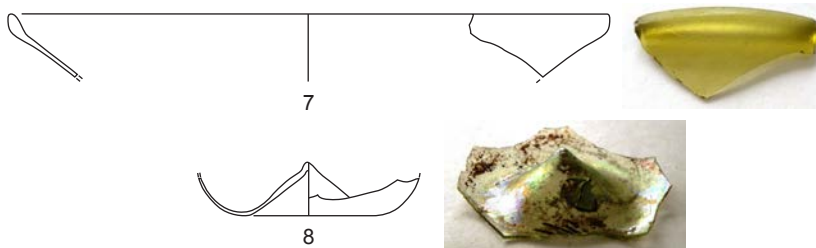

UE.10

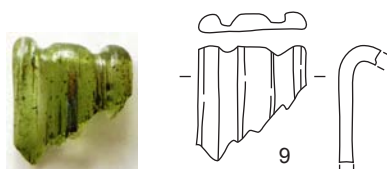

UE.17

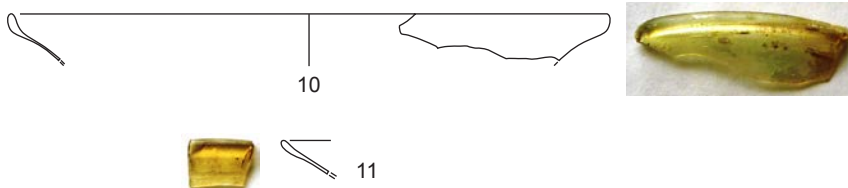

UE.19

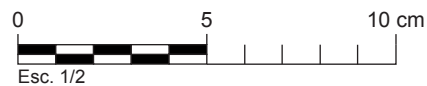
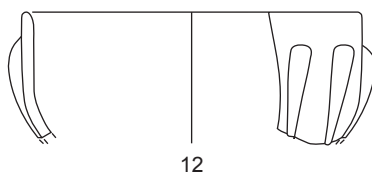

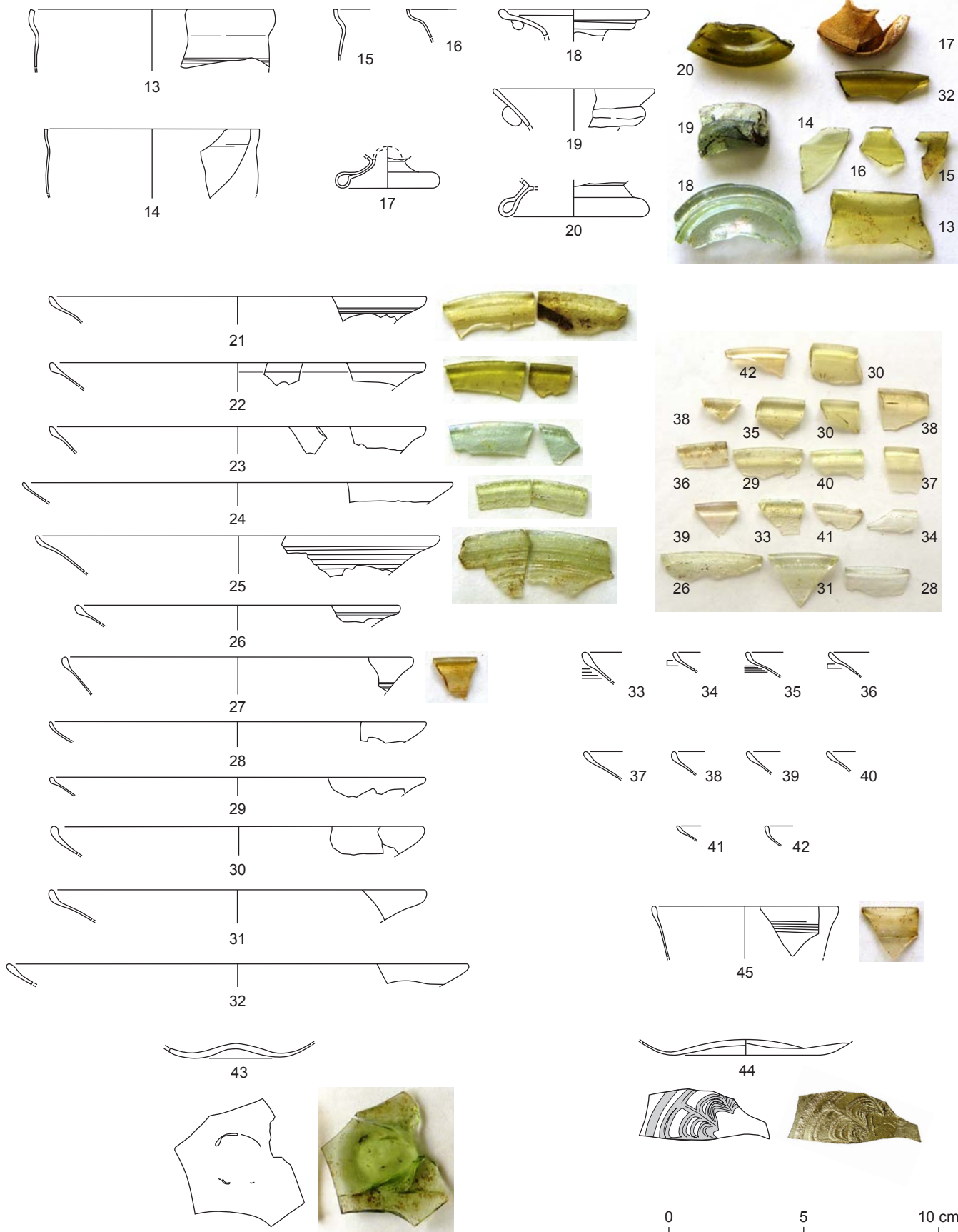

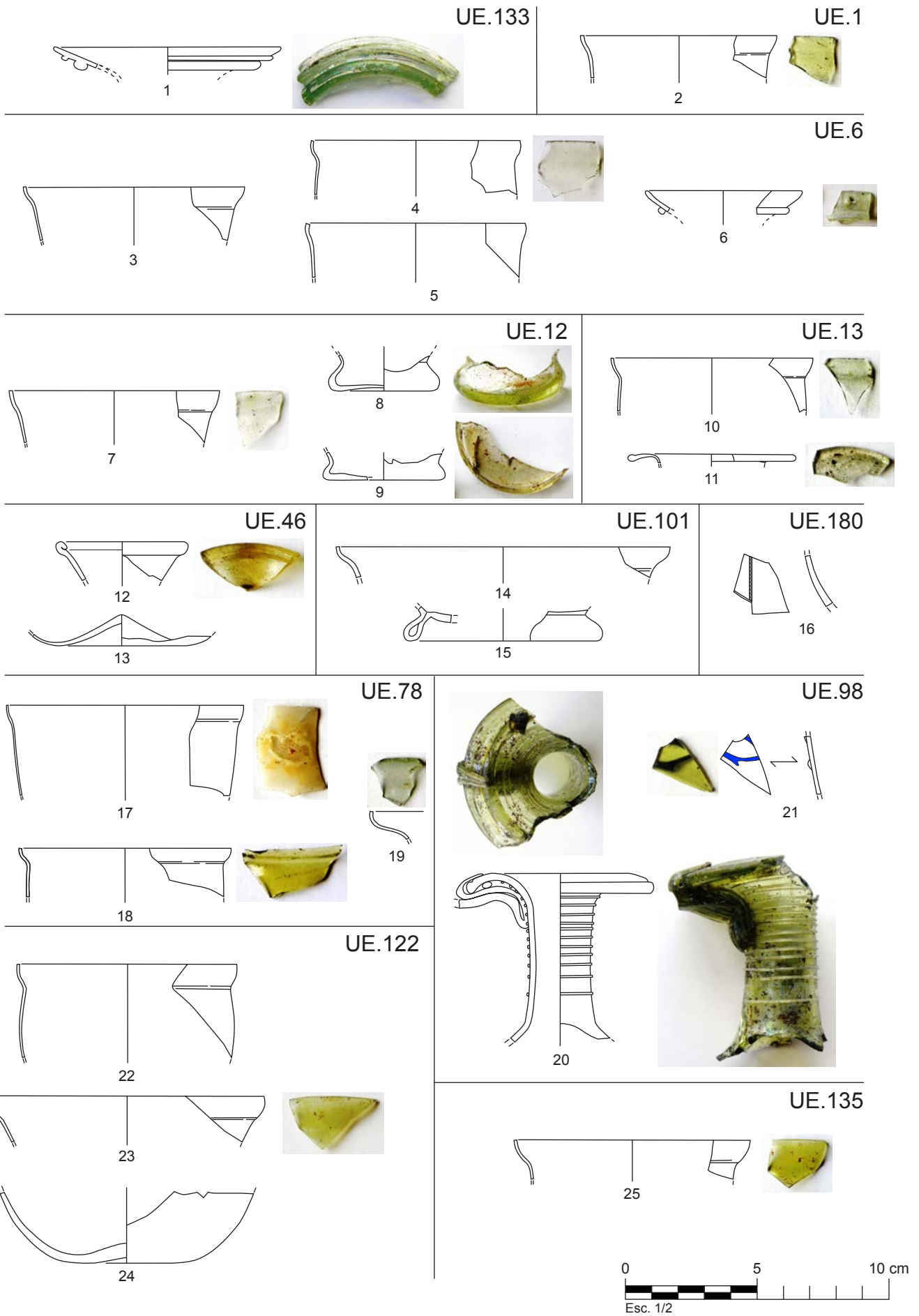

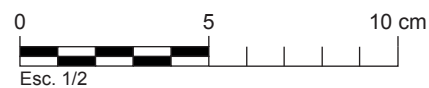
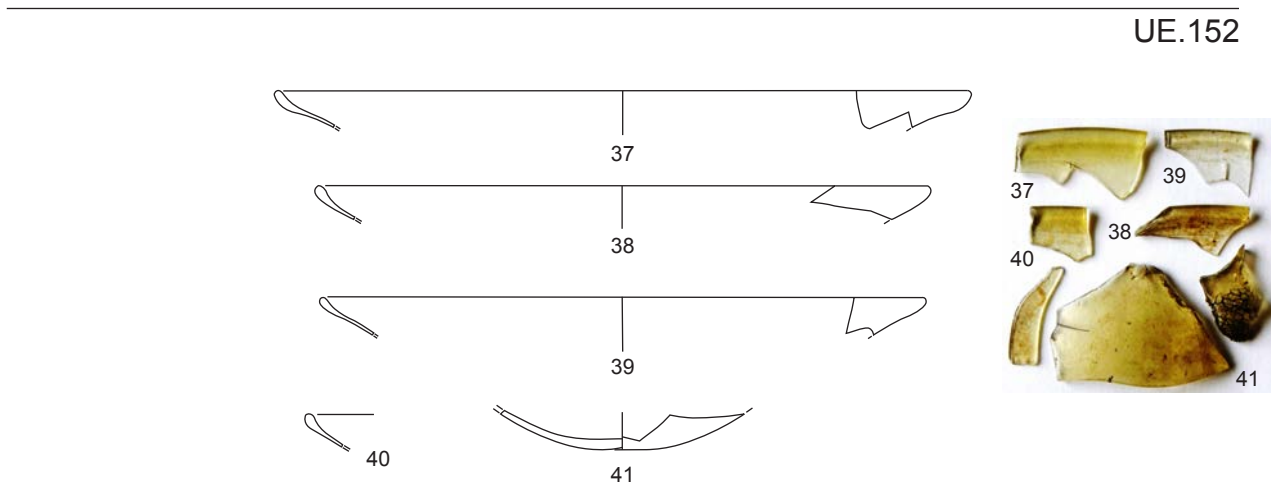
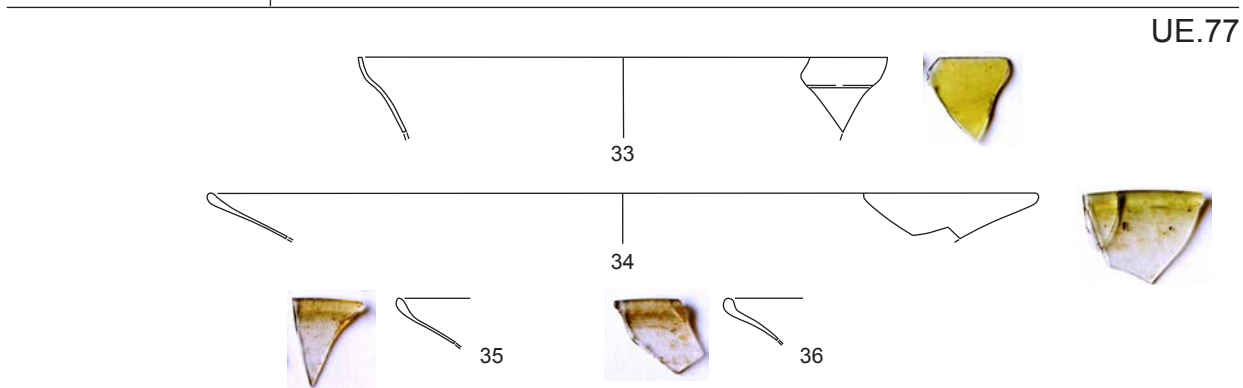
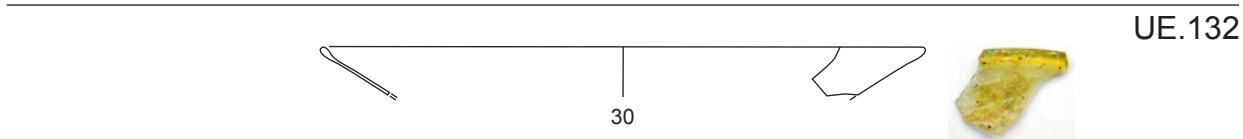
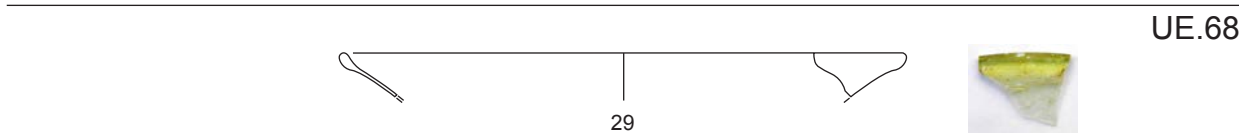
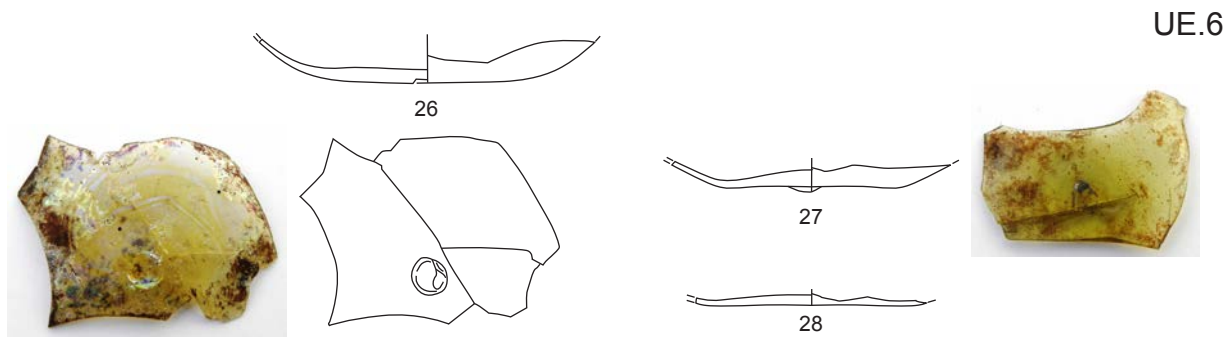

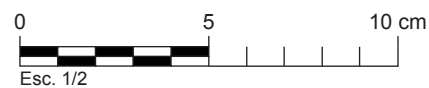
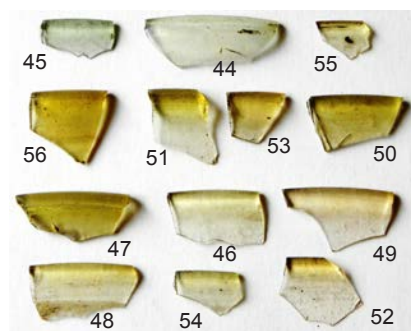
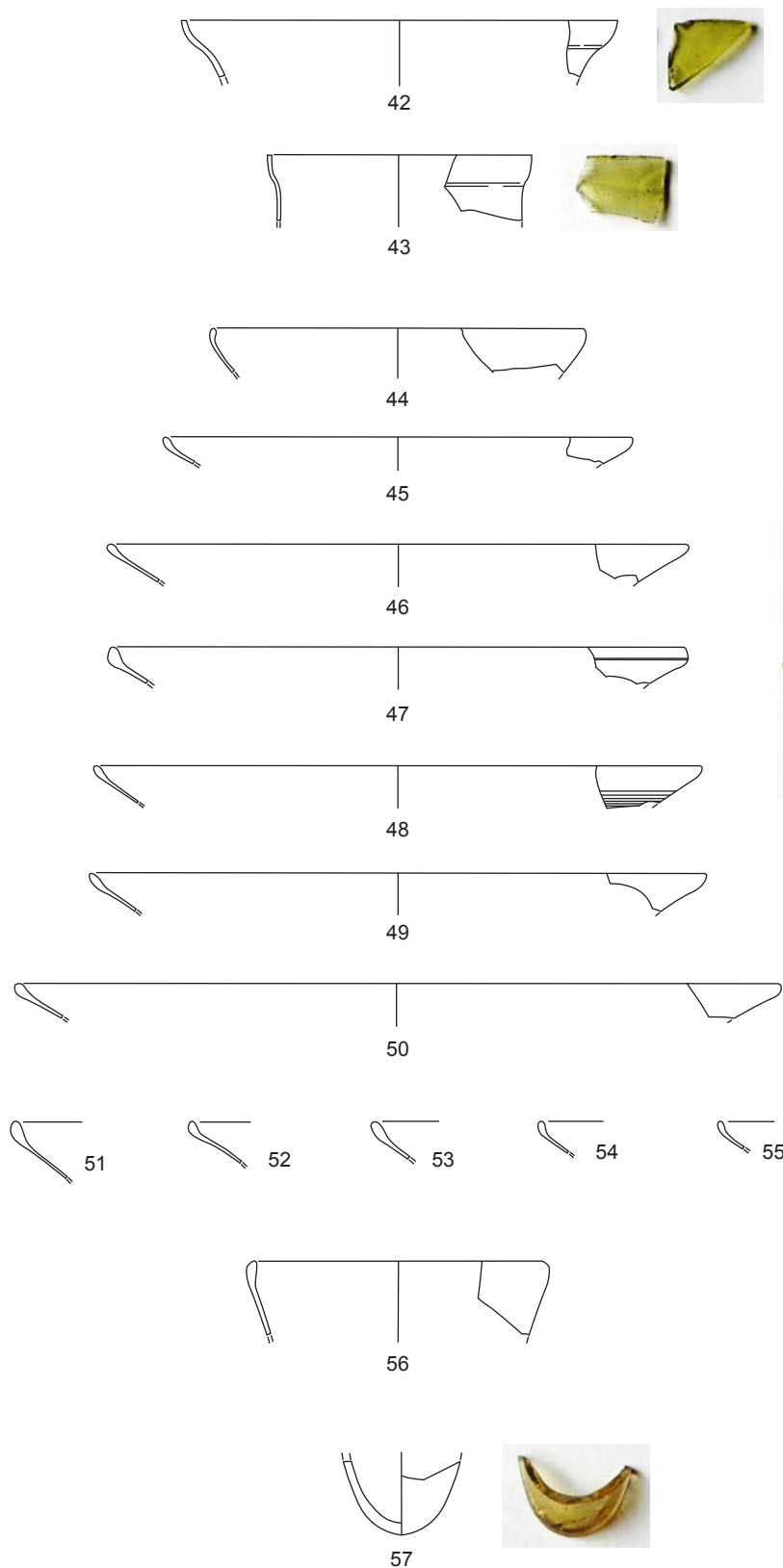



58

59

UE.26

UE.83

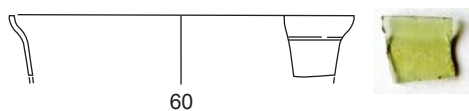

60



61

UE.85



62

UE.91



63

UE.95

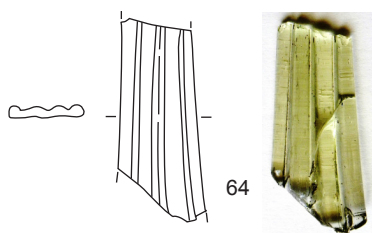

64

UE.154



65

UE.1029

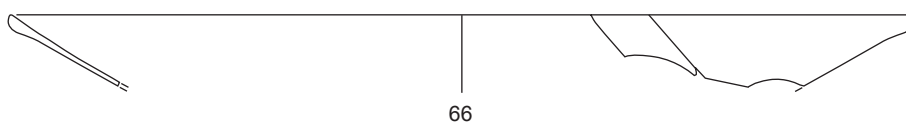

66



67

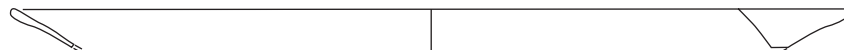

68

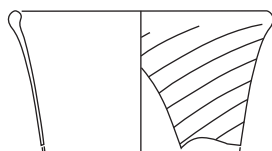

69

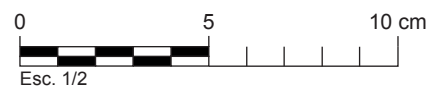

Est.3-Ue.8

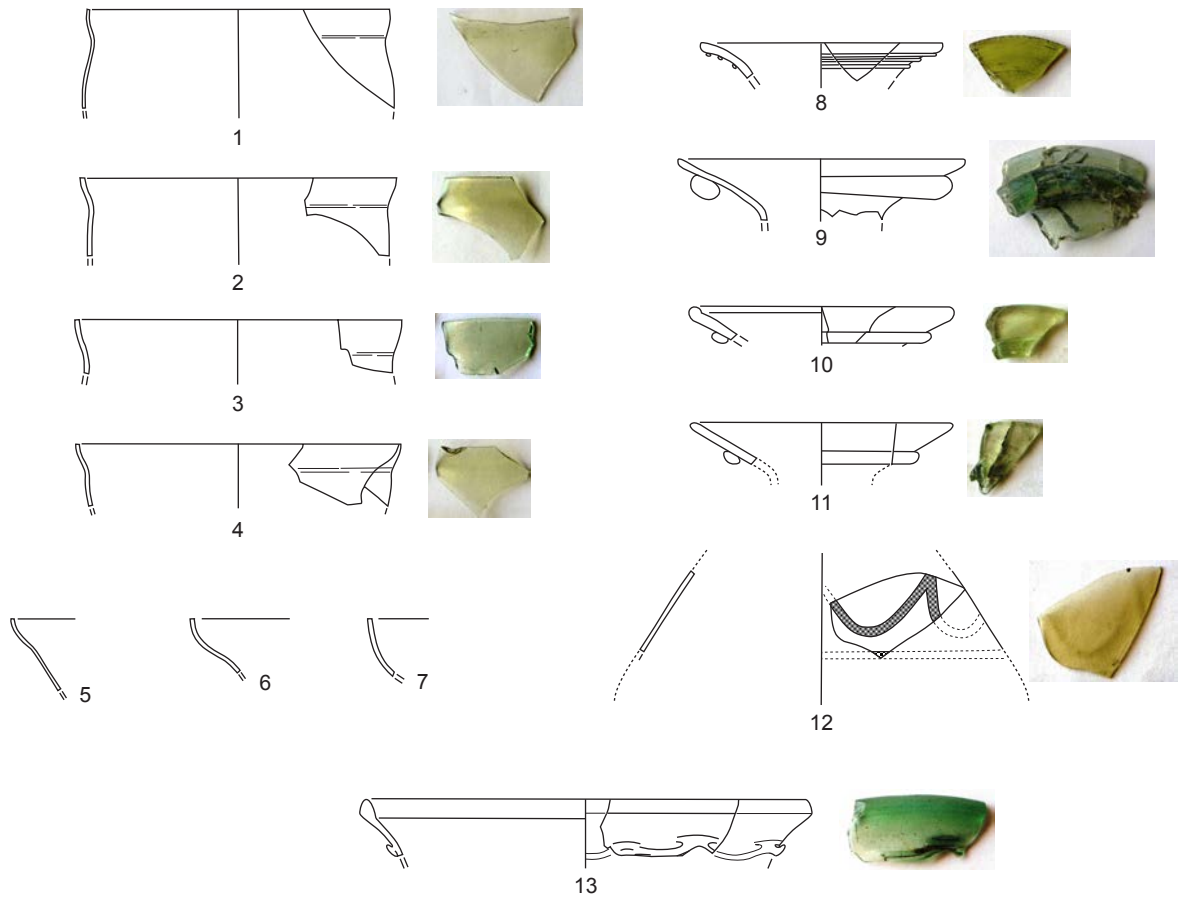

Est.3-Ue.10

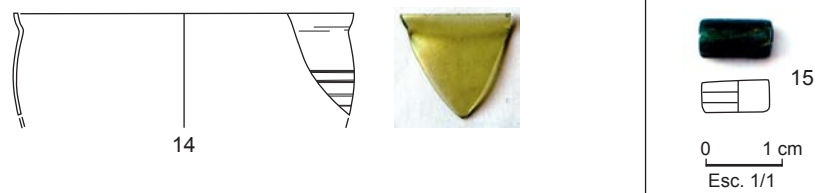

Est.3-Ue.53

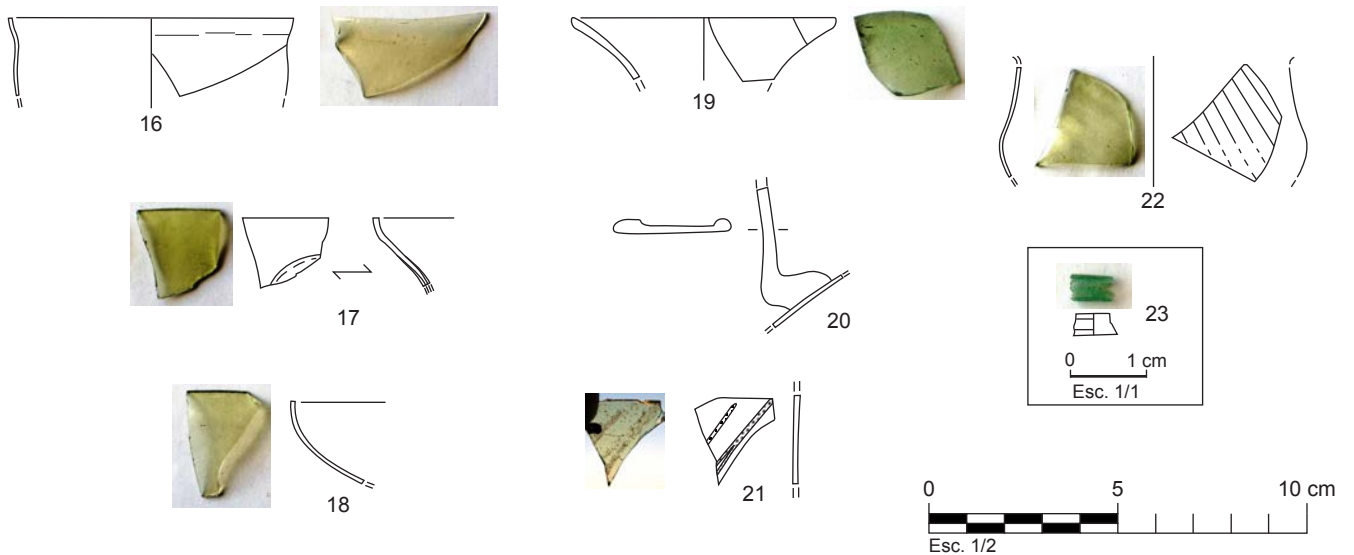



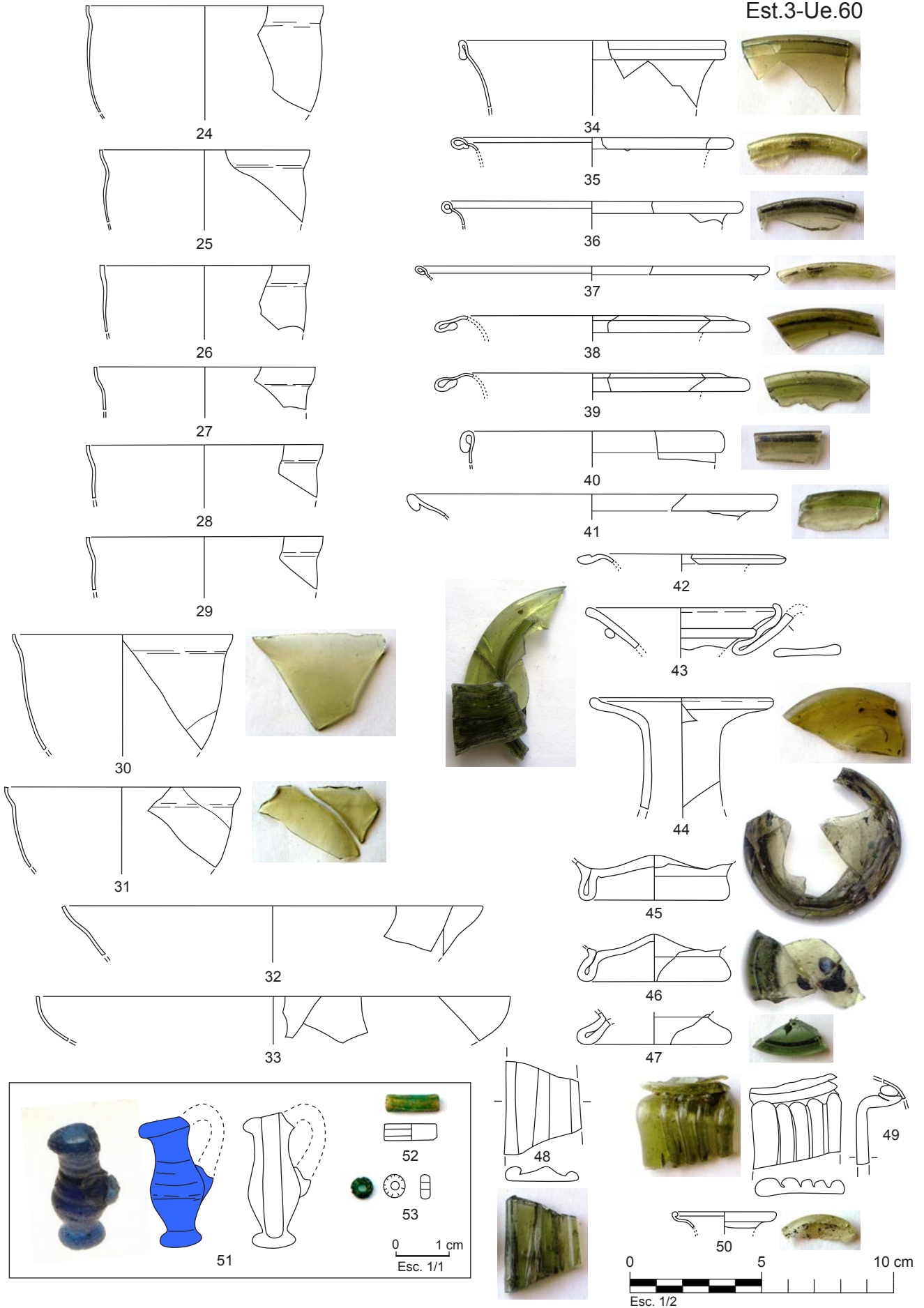

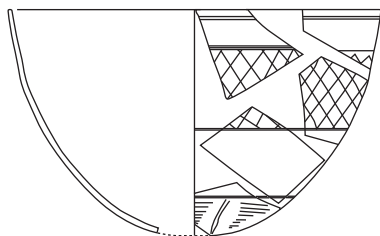

54

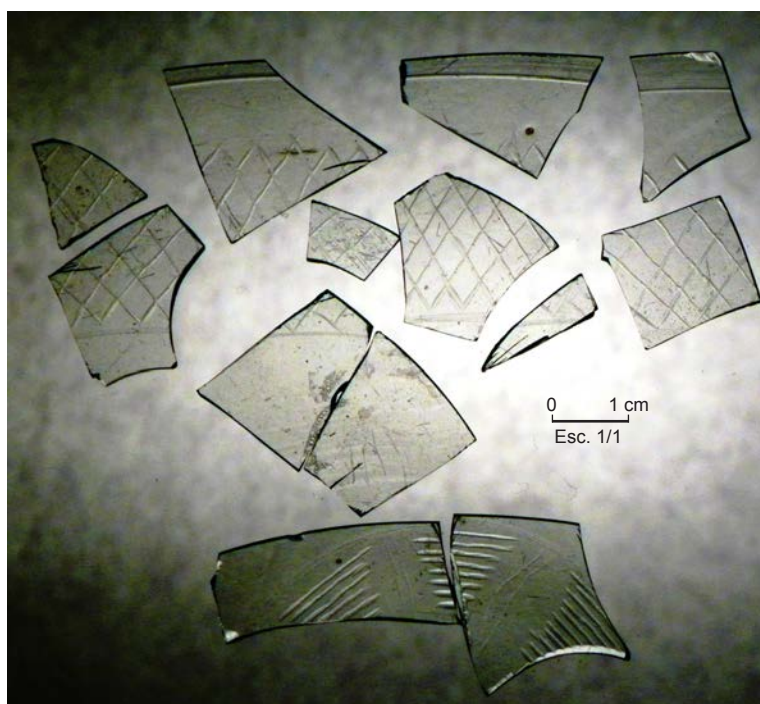
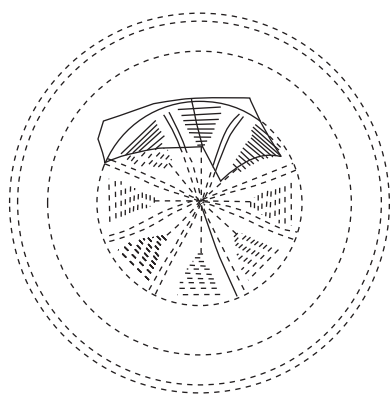
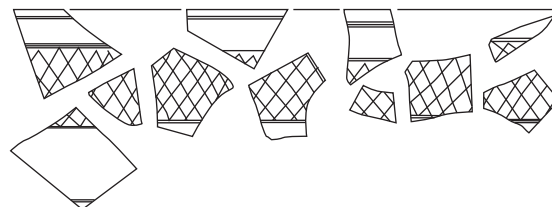

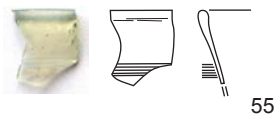

55 56

Est.5-Ues.14,33,36 i 44

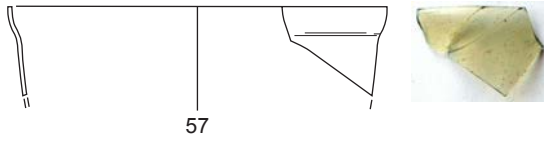

57

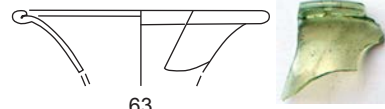

63

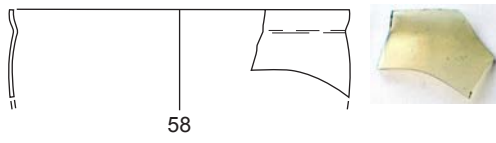

58



64

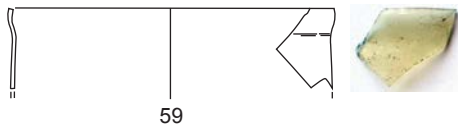

59



60

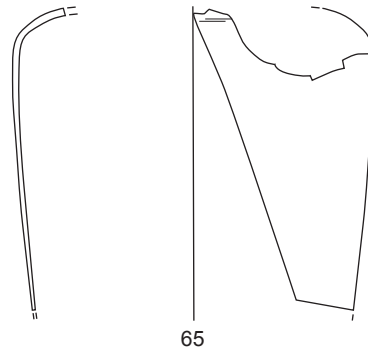

65

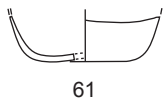

61

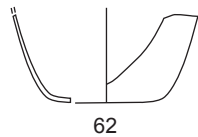

62

Est.7-Ues.18 i 78

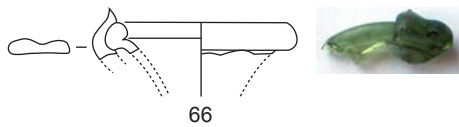

66



67

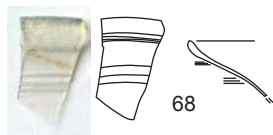

68



69



70



71



72



73



74



70

72

73

71

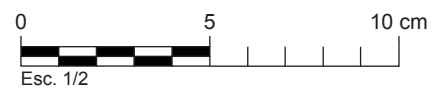

Esc. 1/2

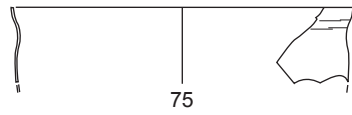

75

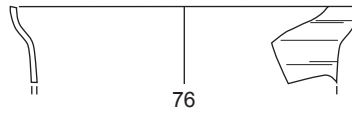

76

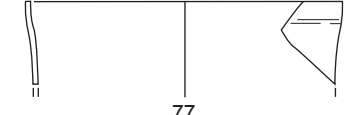

77

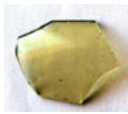

86



87

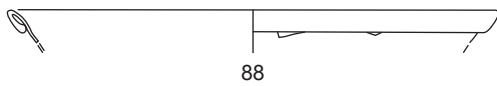

88



89



90

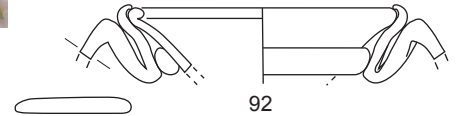

92

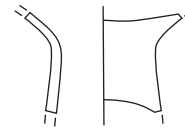

93

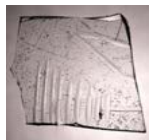

91

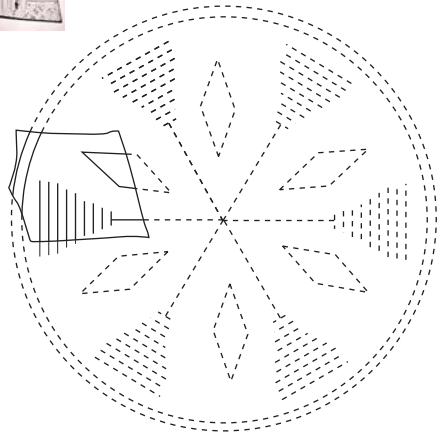
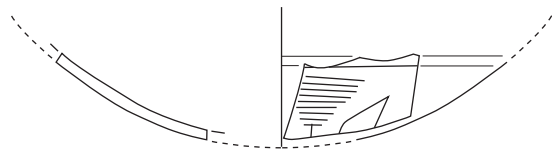

0 1 cm  
Esc. 1/1

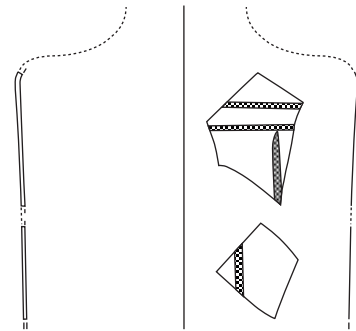

94

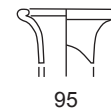

95

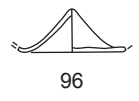

96

0 5 10 cm  
Esc. 1/2

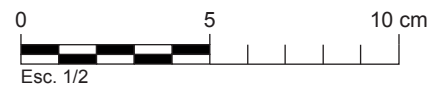
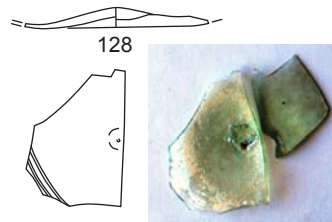
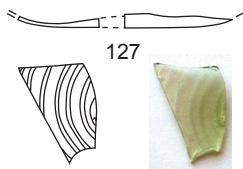
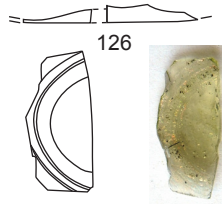
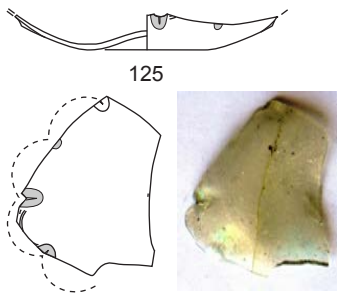
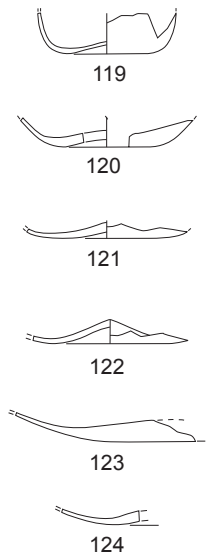
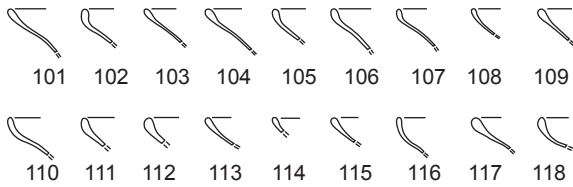
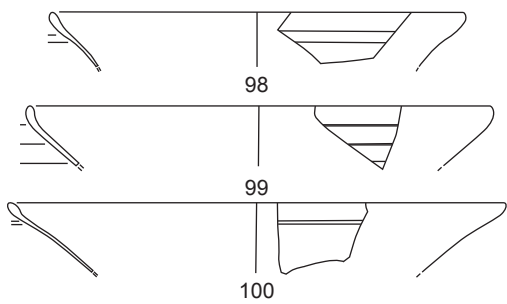
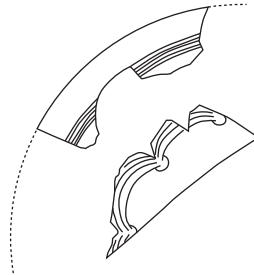
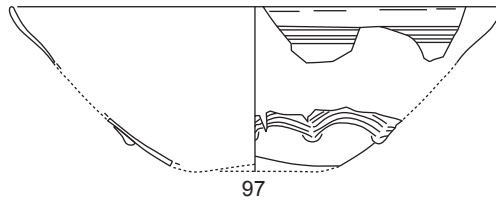

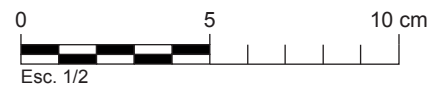
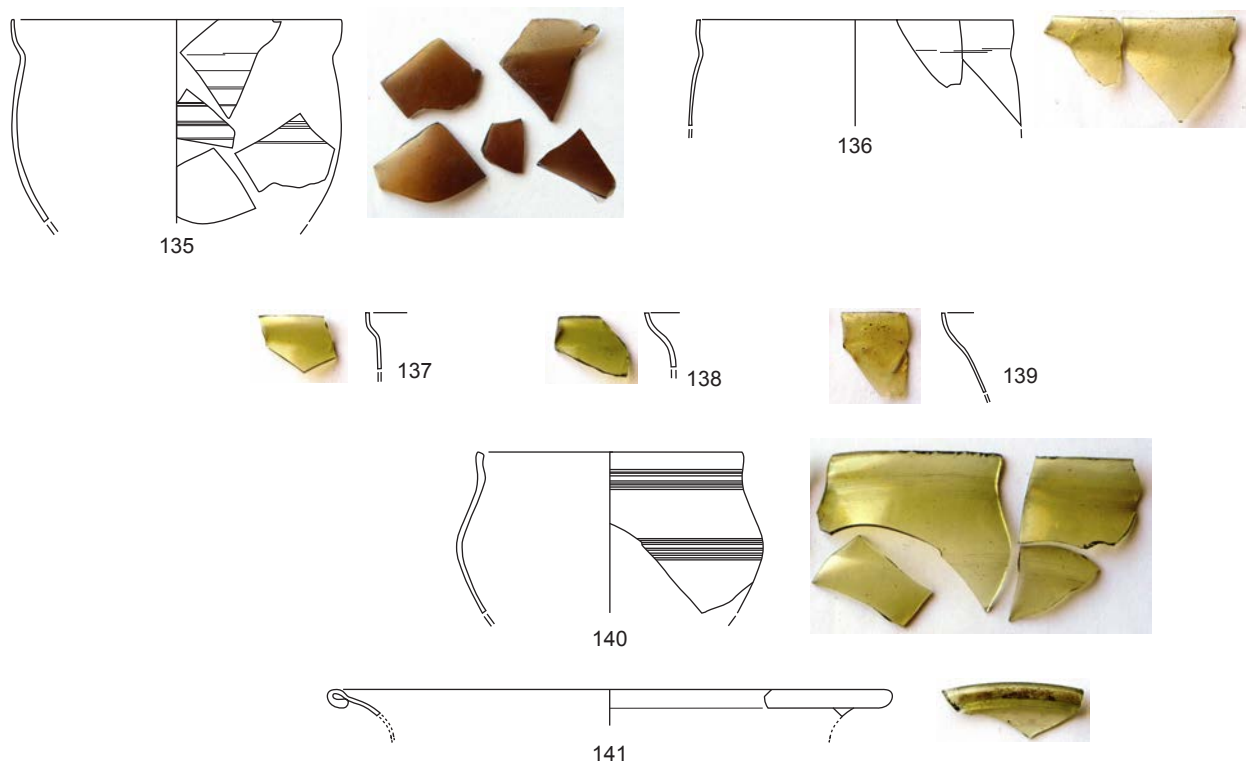
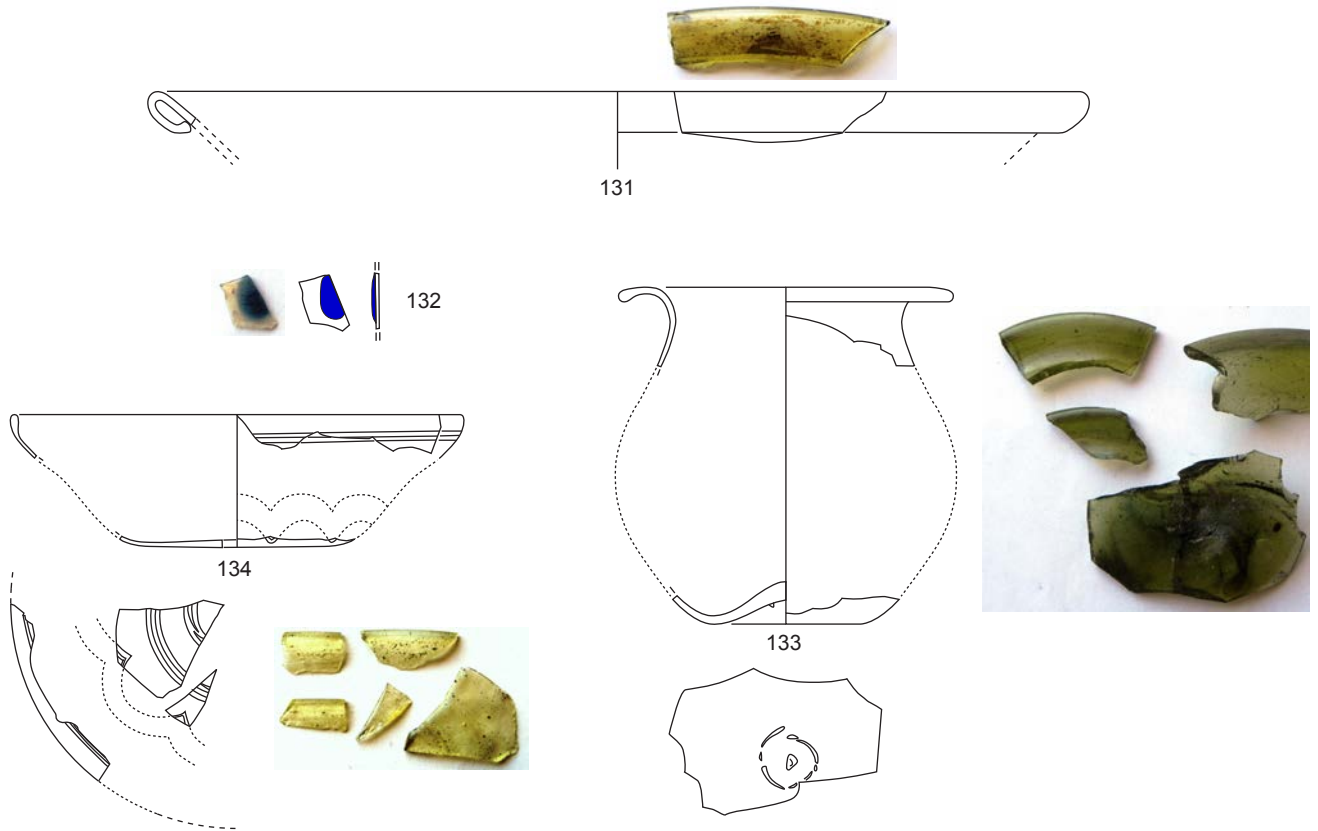

Est.9-Ue.82

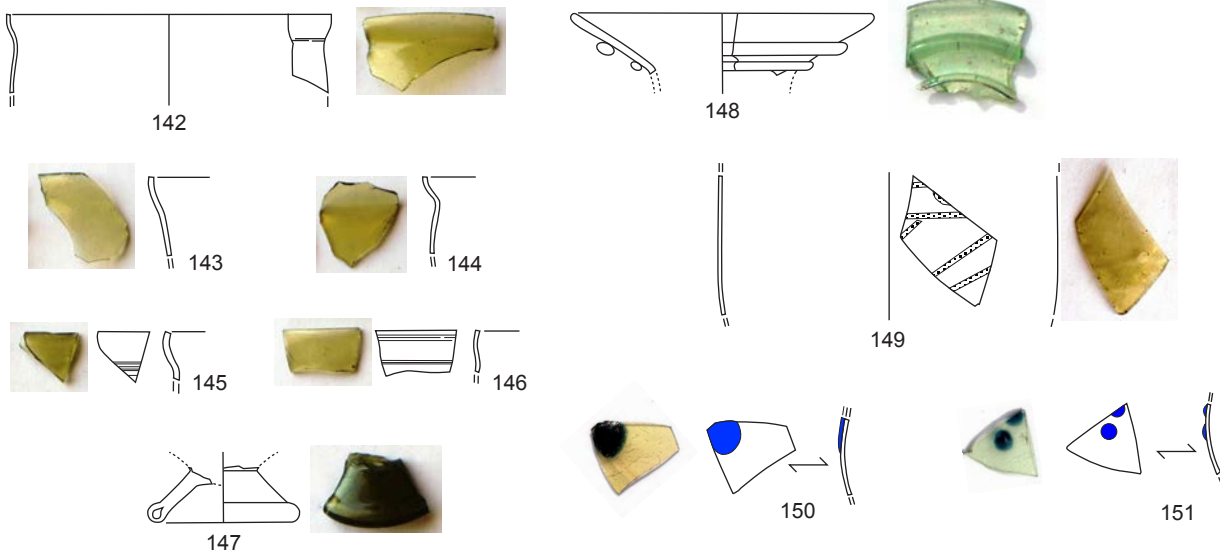

Est.9-Ue.83

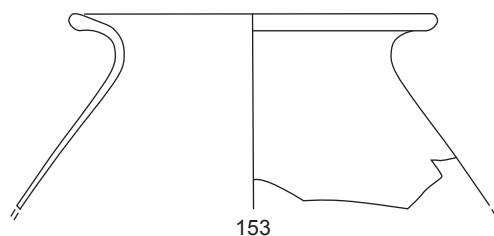
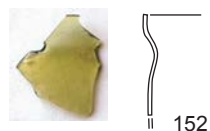

Est.9-Ue.99

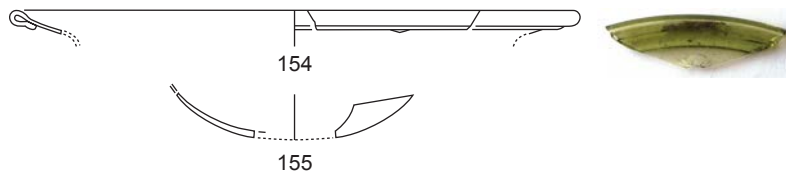

Est.9-Ue.320

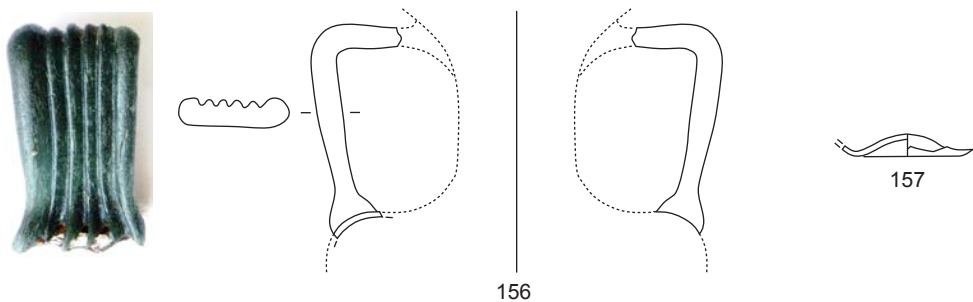

Est.9-Ue.344

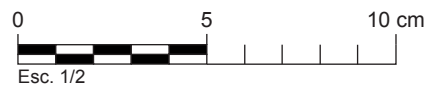

Est.9-Ue.416

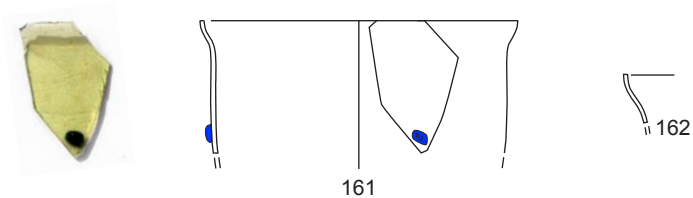

161

162

Est.9-Ue.417

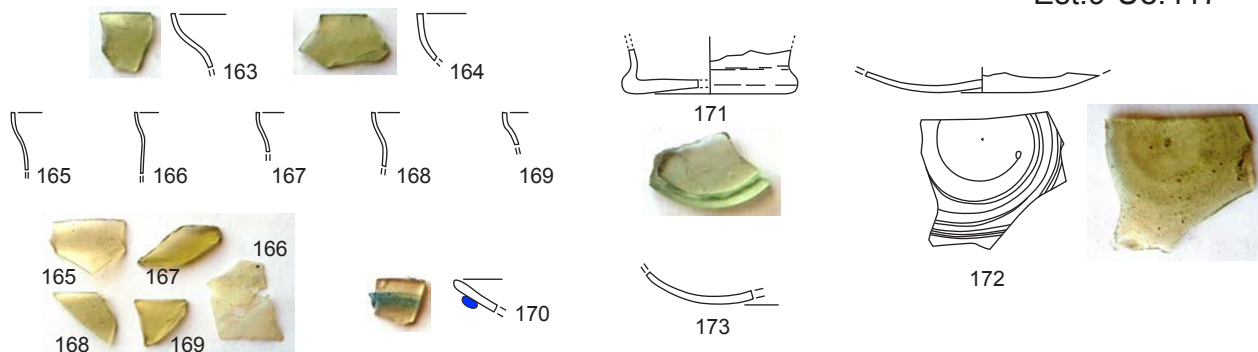

163

164

171

165

166

167

168

169

172

165

167

166

168

169

170

173

Est.9-Ue.425

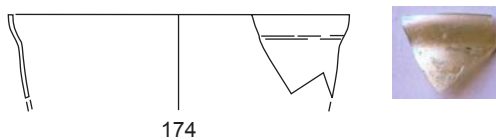

174

Est.9-Ue.463

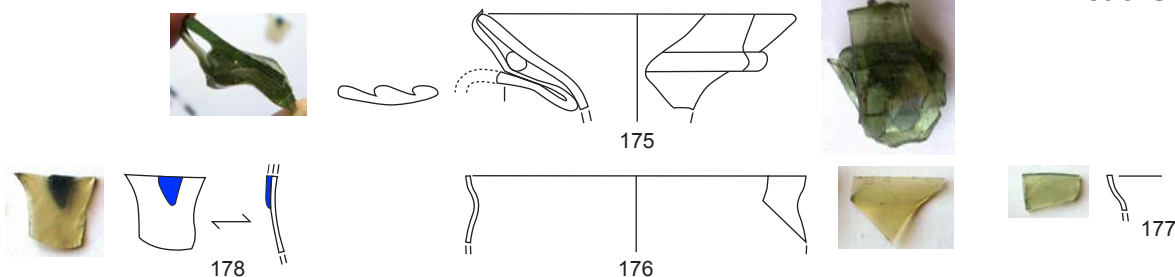

175

176

177

178

Est.9-Ue.464

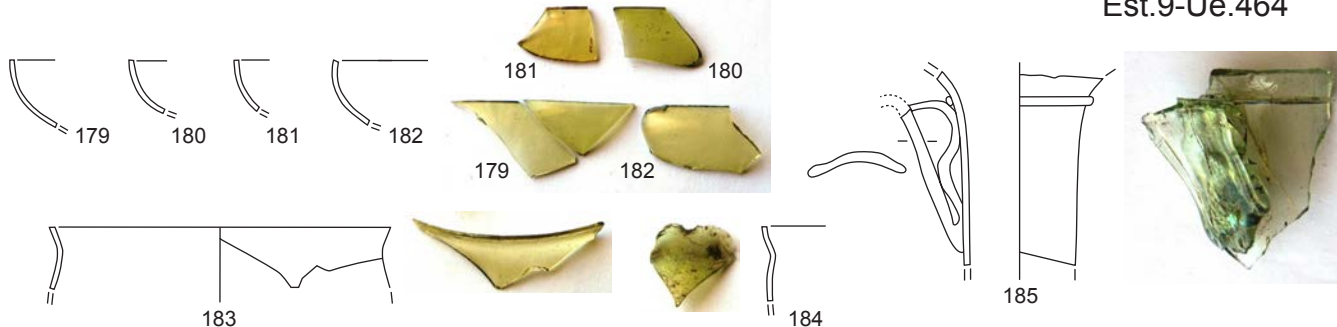

179

180

181

182

181

180

179

182

183

184

185

Est.10-Ue.26

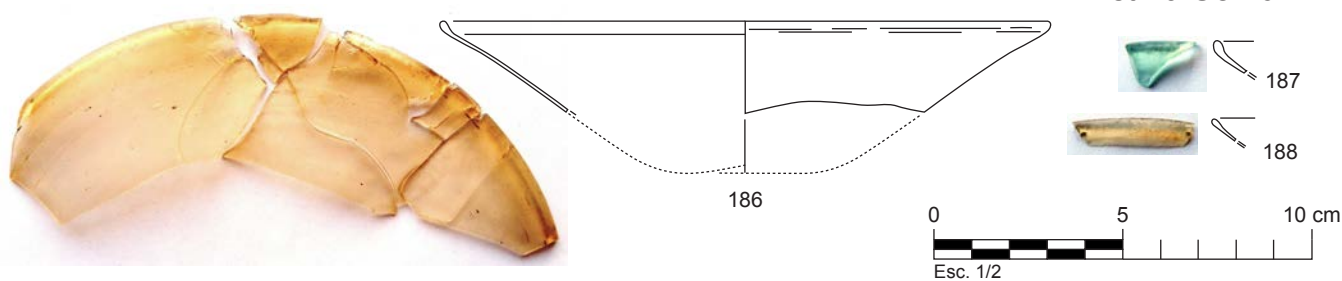

186

187

188

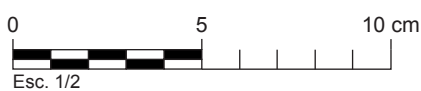

Esc. 1/2



Est.12-Ue.164

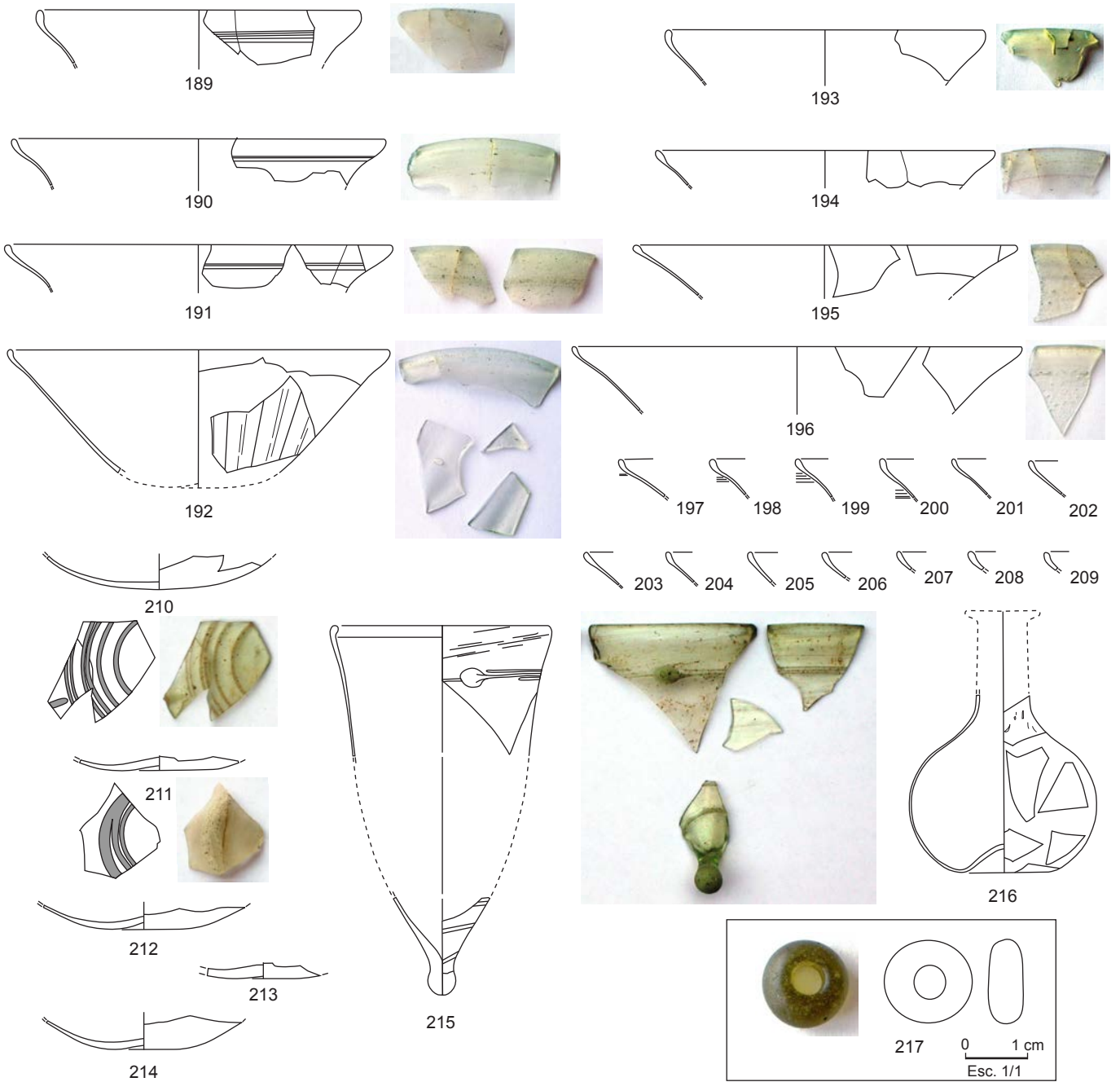

Est.13-Ue.73

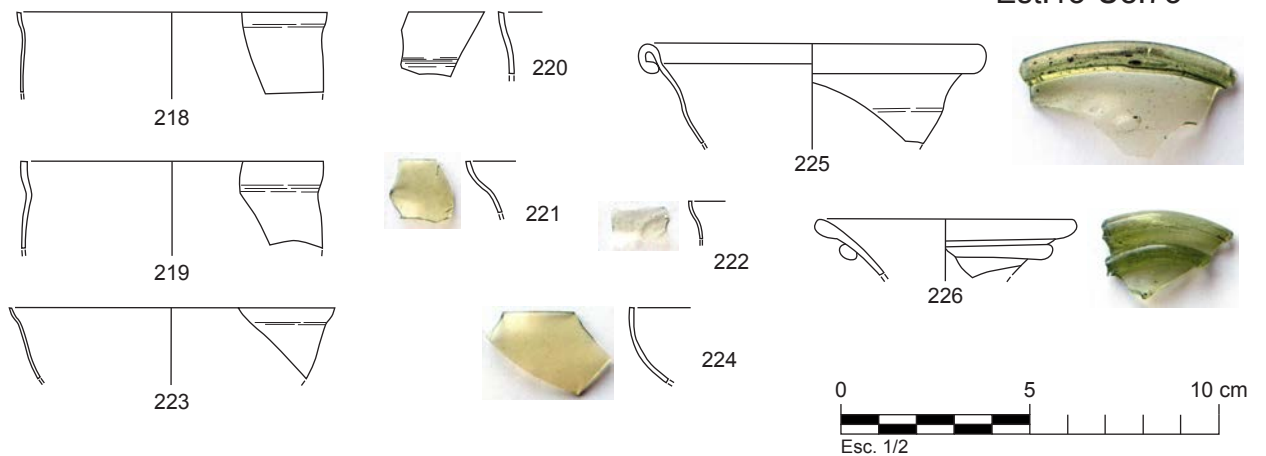

Est.23-Ue.132



227

Est.24-Ue.165



228

Est.27-Ue.143

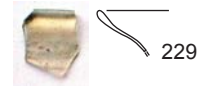

229

Est.30-Ue.149

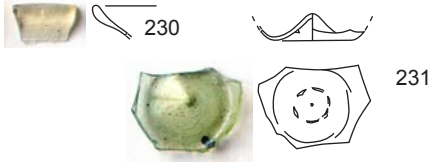

230

231

Est.30-Ue.189

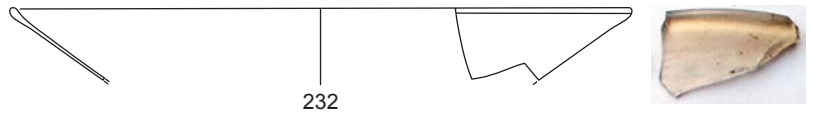

232

Est.31-Ue.155

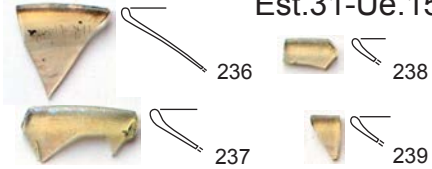

236

238

237

239

233

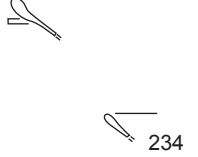

234

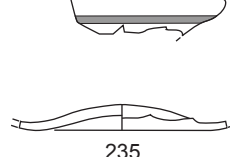

235

Est.32-Ue.162

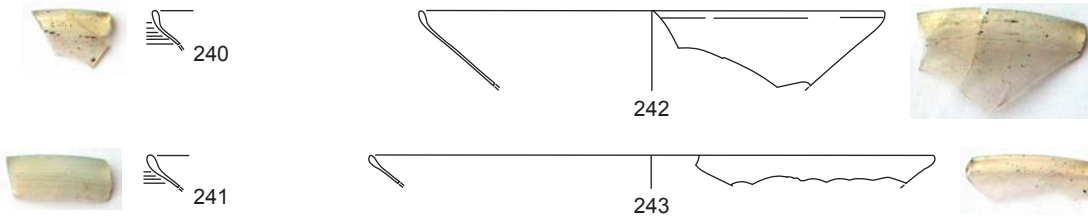

240

241

242

243

Est.32-Ue.163

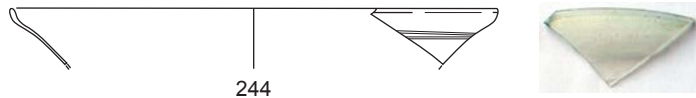

244

Est.32-Ue.287

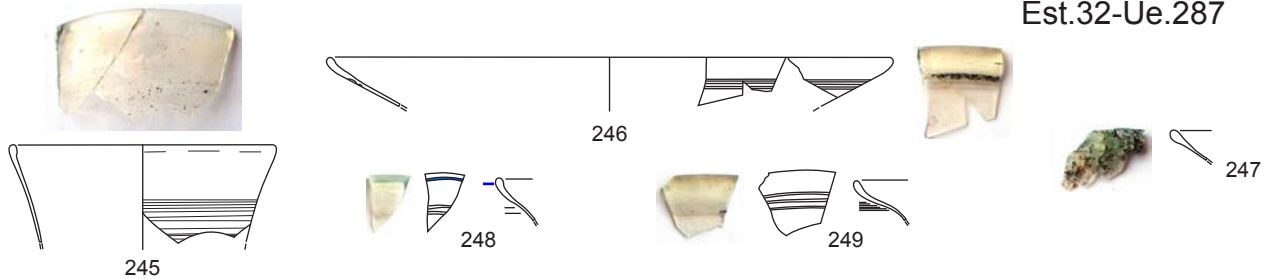

245

246

248

249

247

Est.34-Ue.169

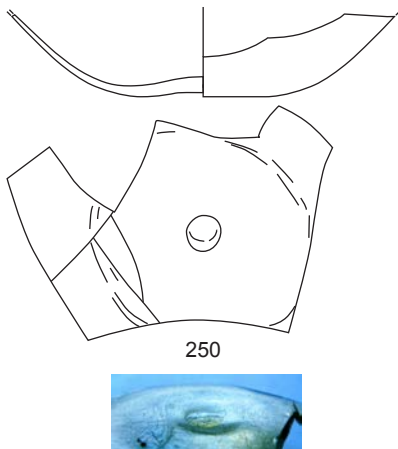

250

Est.36-Ue.193



251

252

Est.40-Ue.187

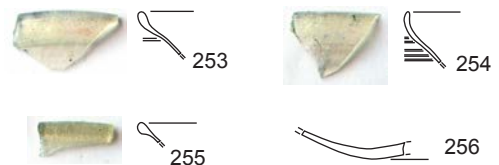

253

254

255

256

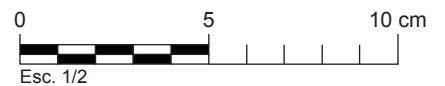

Esc. 1/2

Est.7-Ue.24



Est.13-Ue.39

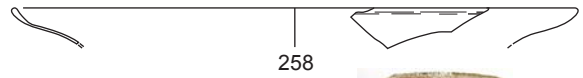

Est.14-Ue.41

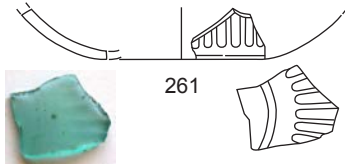

Est.15-Ue.44

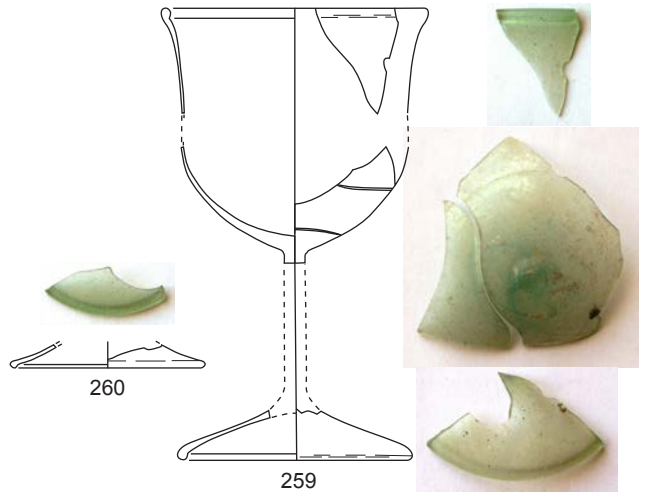
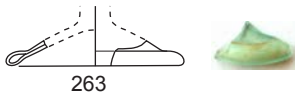

Est.16-Ue.46

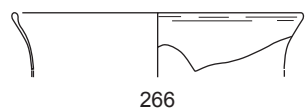
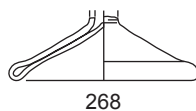
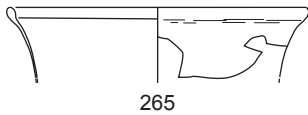
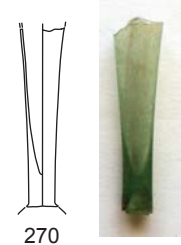
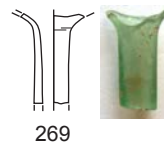
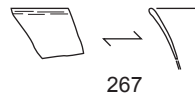
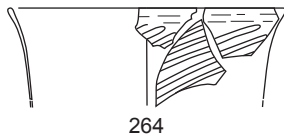

Est.20-Ue.58

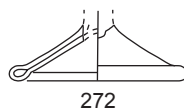
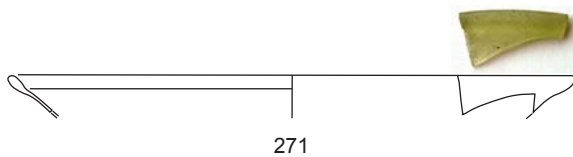

Est.21-Ue.60

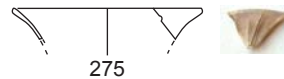
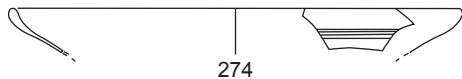

Est.29-Ue.78



Est.30-Ue.80



Est.31-Ue.82

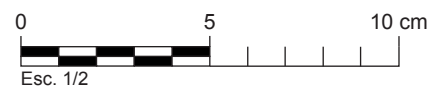
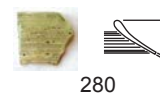

Est.64-Ue.517



282



283

Est.70-Ue.533



284



Est.75-Ue.582

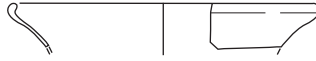

285



Est.81-Ue.555



286



Est.82-Ue.557



287



Est.84-Ue.574



289

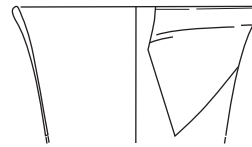

288



Est.87-Ue.567



290



Est.91-Ue.579



291

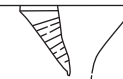

Est.90-Ue.577

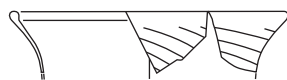

292

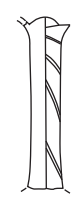

293

Est.96-Ue.593



294

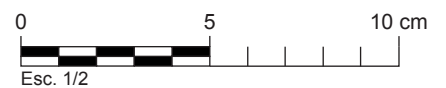

Esc. 1/2

UE.82

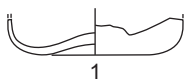

UE.84



UE.91

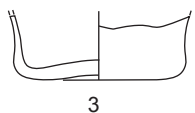

UE.102

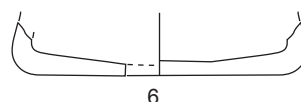

UE.106

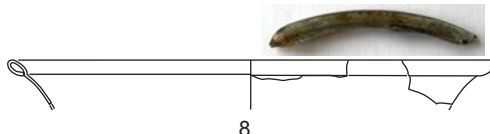

8

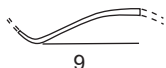

9



10



11



12

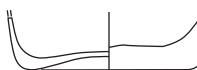

13

UE.120

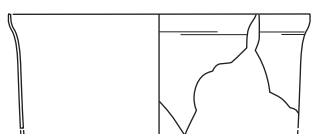

14



15

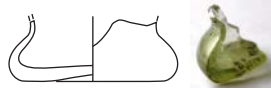

16

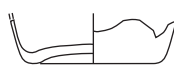

17

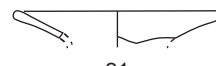

21



18



19



20



20



22

UE.122

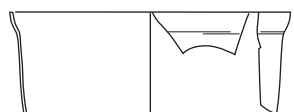

23

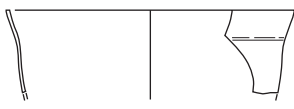

24

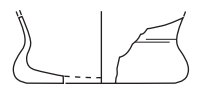

25



26

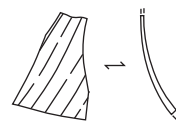

27

UE.128

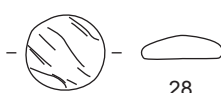

28

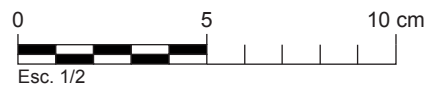

UE.132

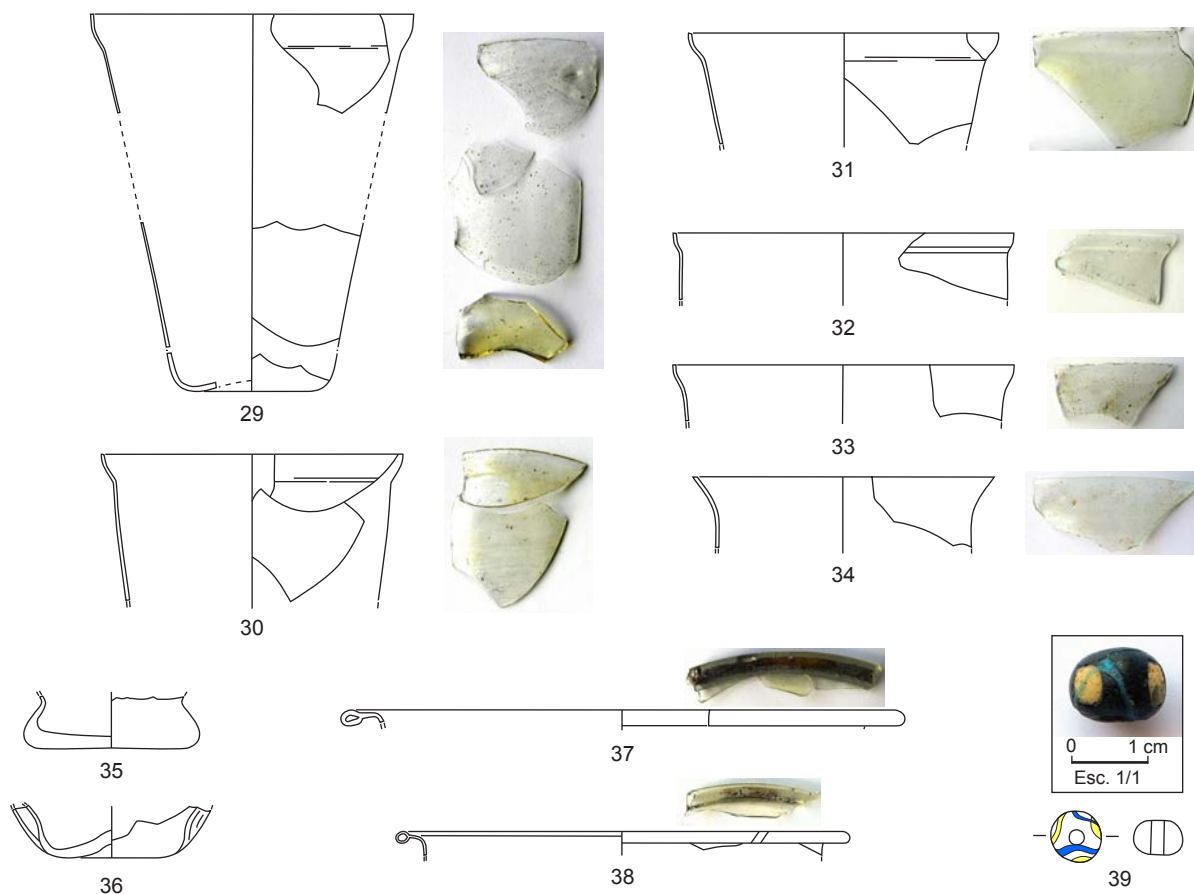

UE.11

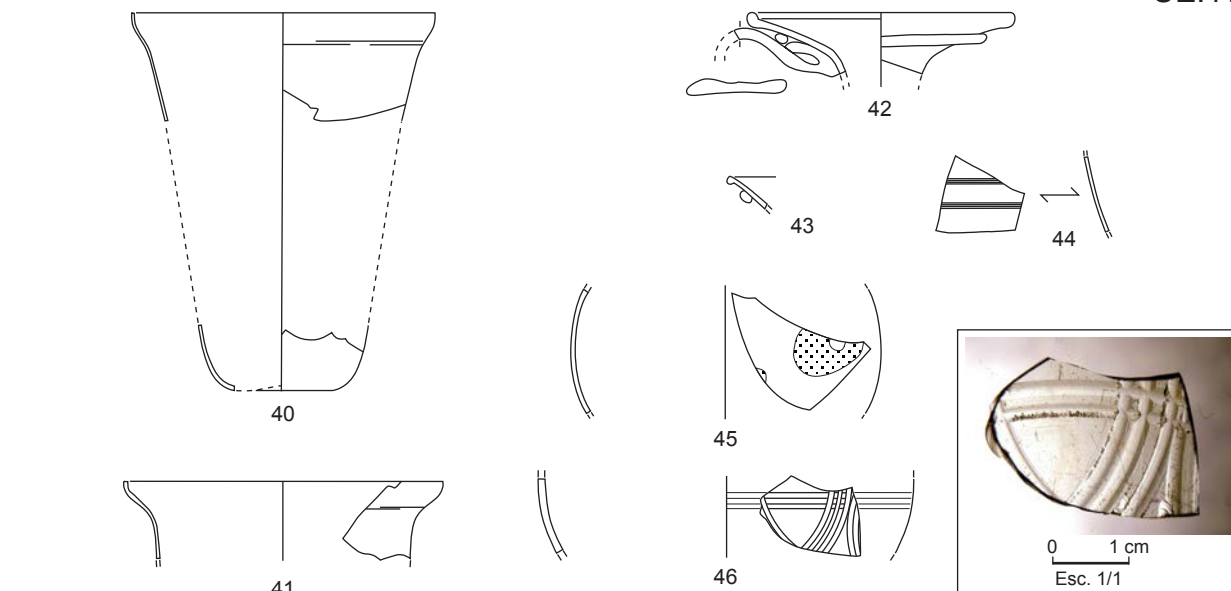

UE.13

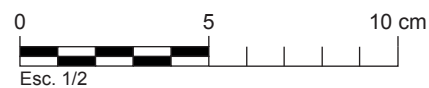

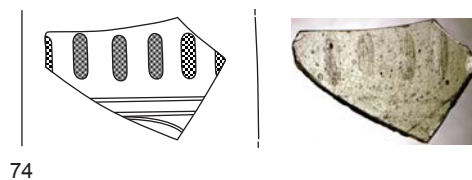
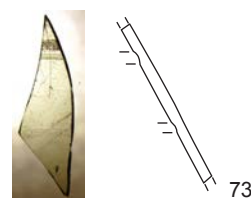
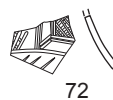
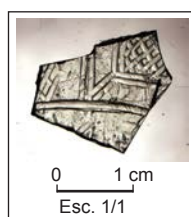
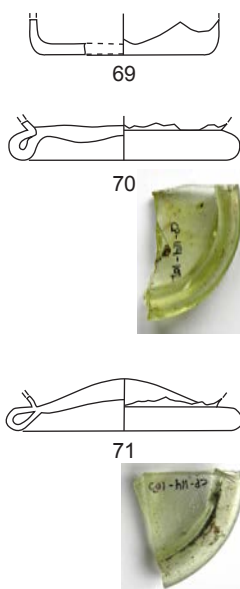
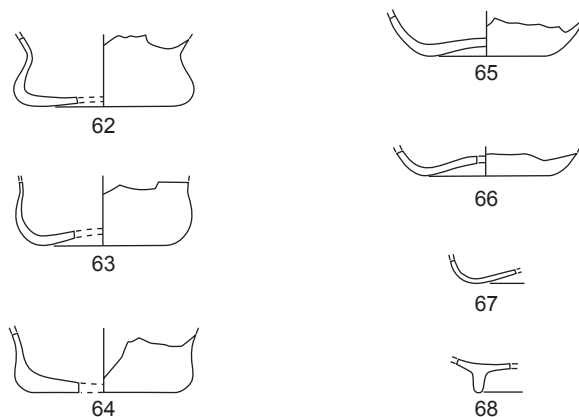
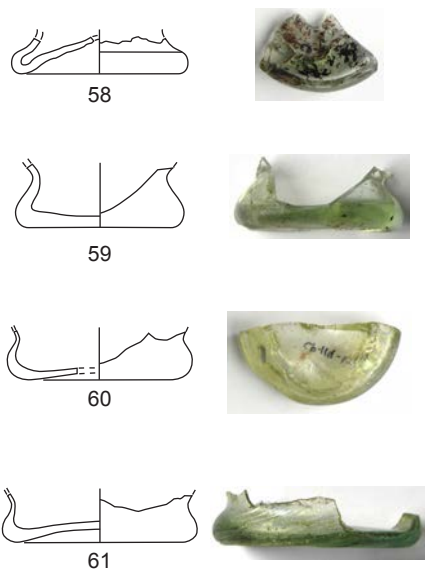
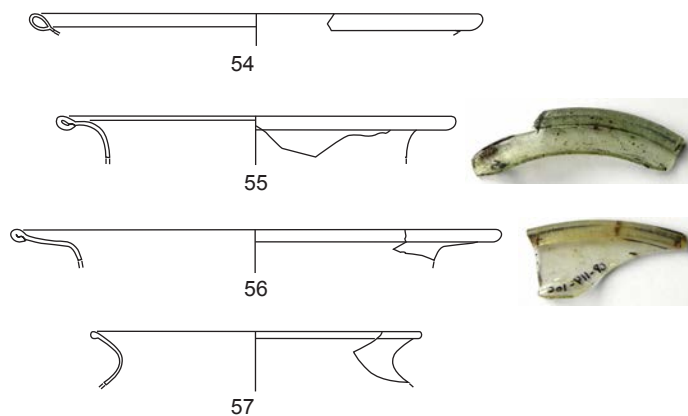
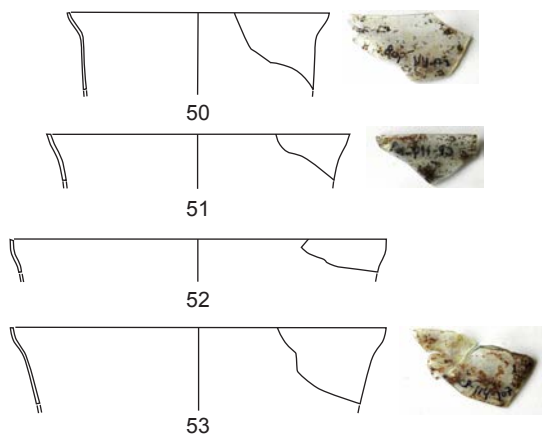

UE.114

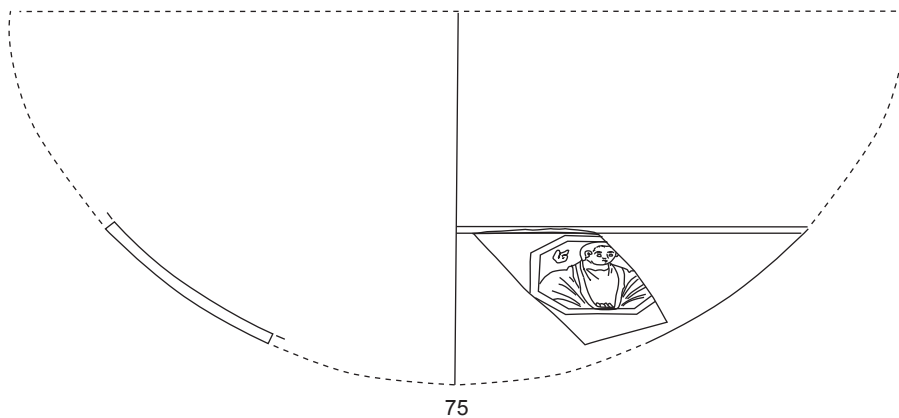
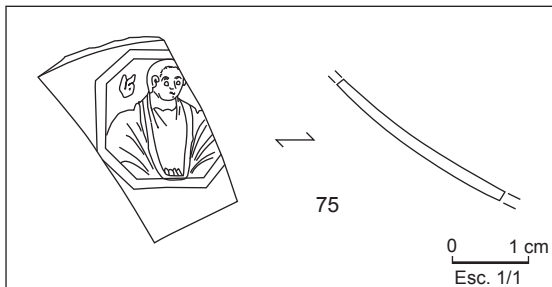

UE.116



UE.124

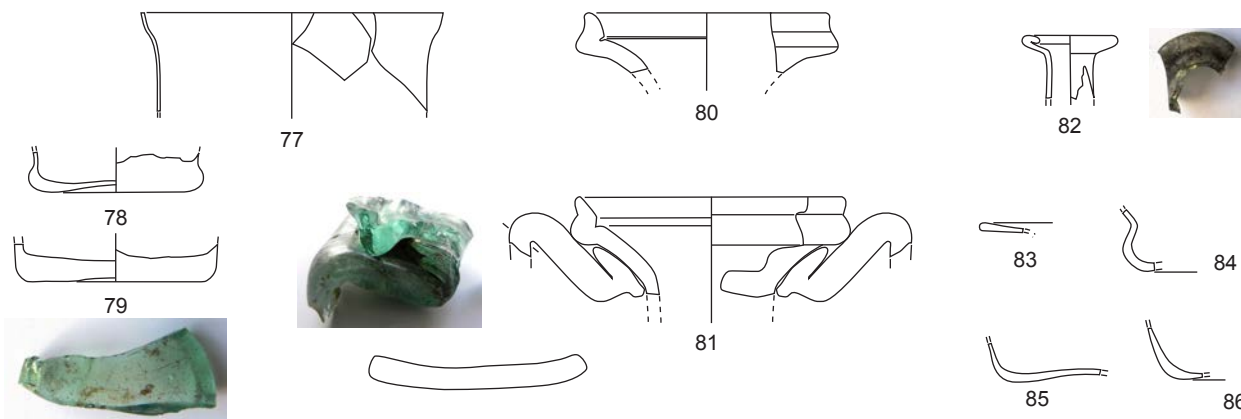

UE.135

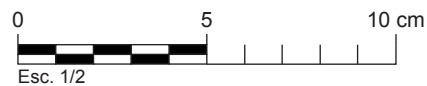
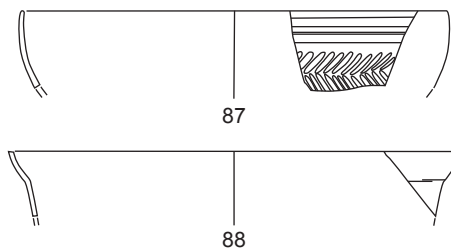
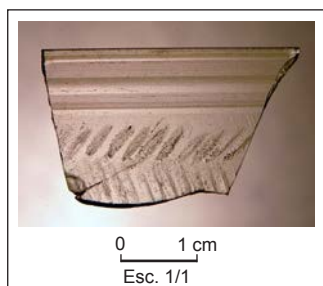



UE.70

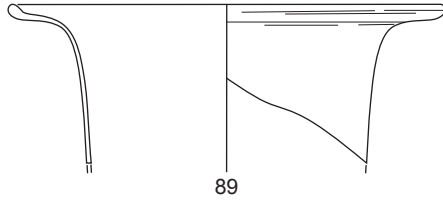

UE.39

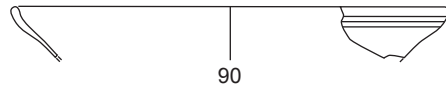

UE.66

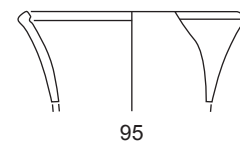
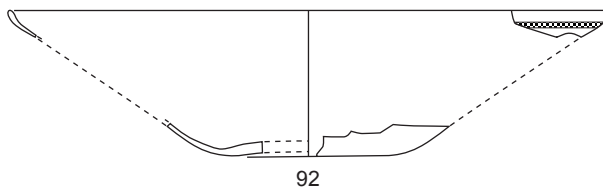
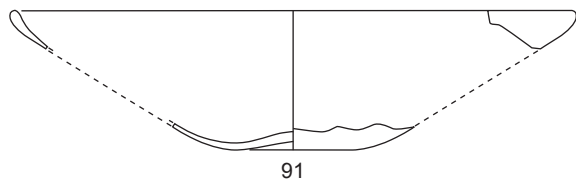

UE.130

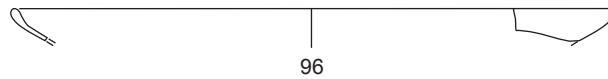

Cova del Comte - Guanta (Sentmenat) 1973

Nivell general

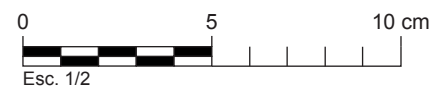
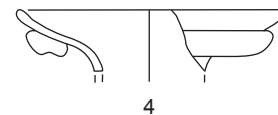
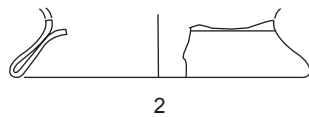
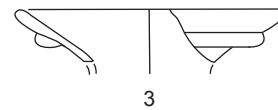

UE.435

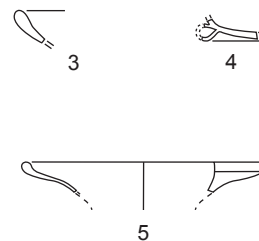
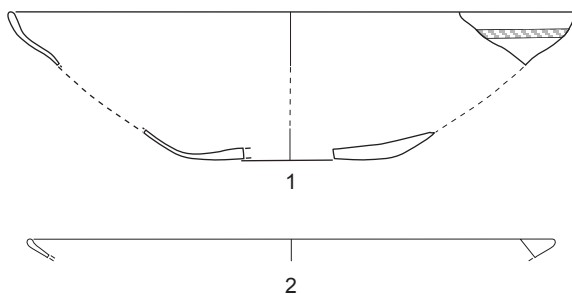

UE.134

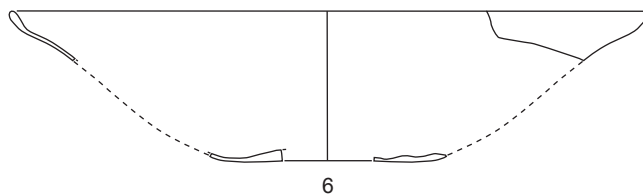

UE.144

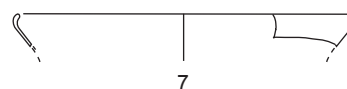

UE.206

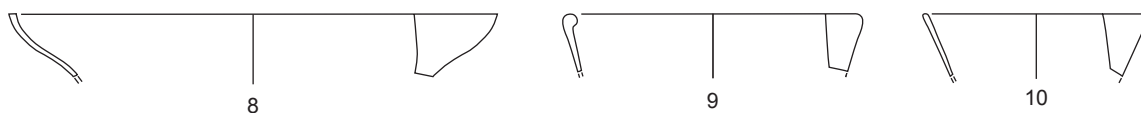

UE.110

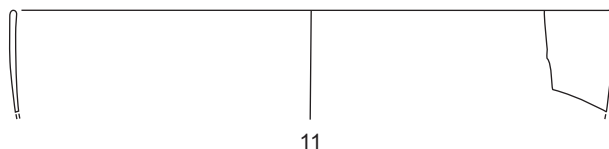

UE.139



UE.113

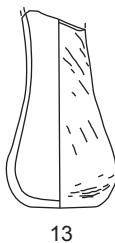

13

UE.120

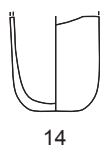

14

UE.480



15

UE.601



16

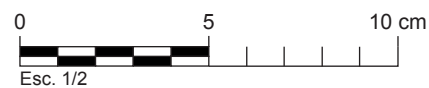

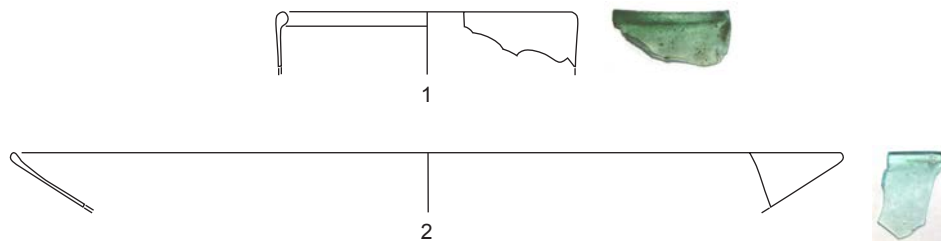

Bòbila Bell-Solà (Santa Perpètua de Mogoda)

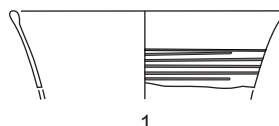

Can Bernades (Santa Perpètua de Mogoda)

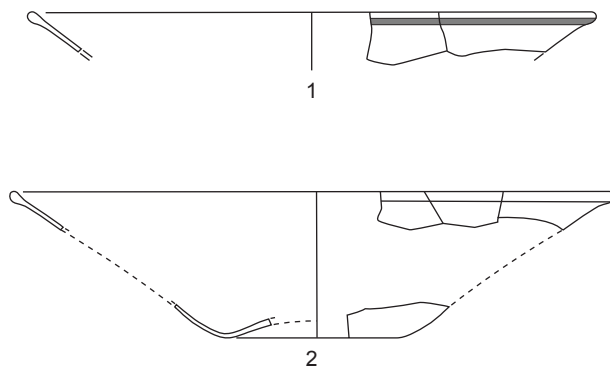

Els Vinalets (Santa Perpètua de Mogoda)

UE.32

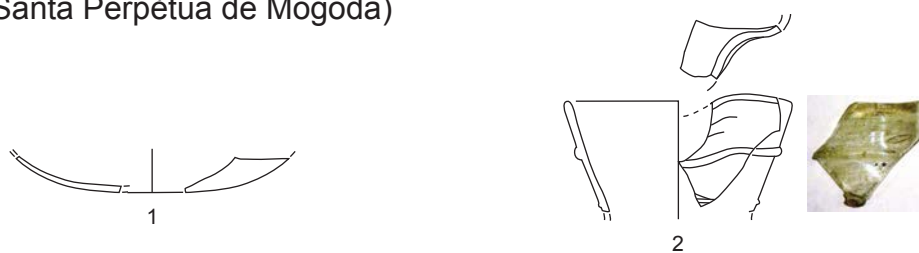

UE.76

UE.86

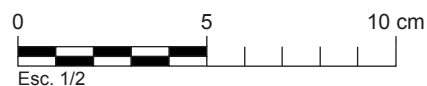
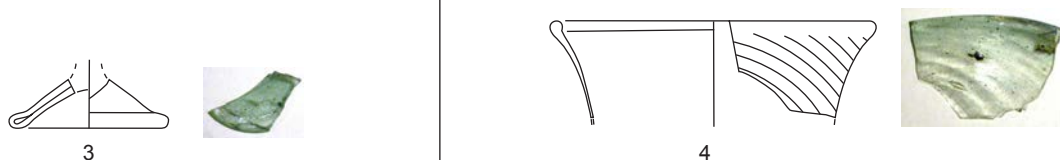

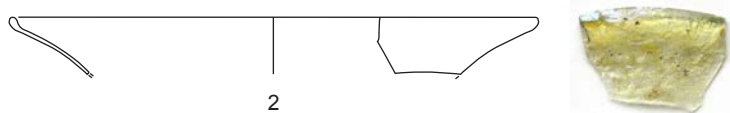
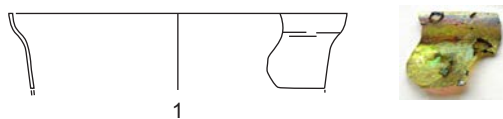

UE.23

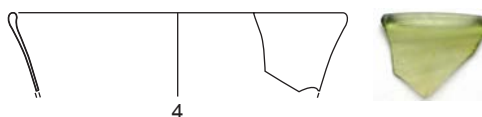

UE.153

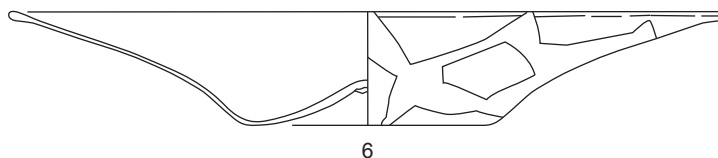
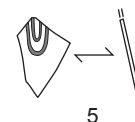

UE.274



UE.349

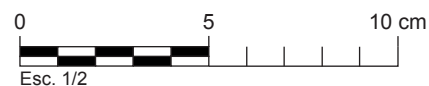
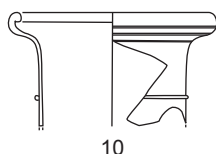
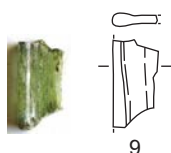

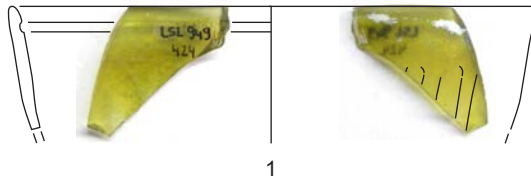

1

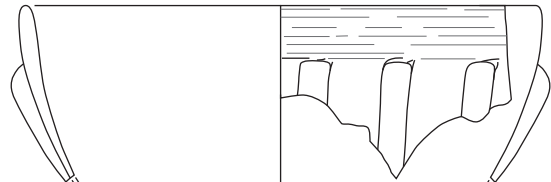

3

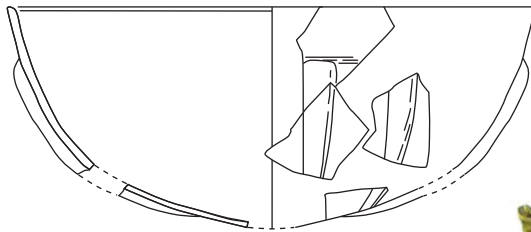

2



4

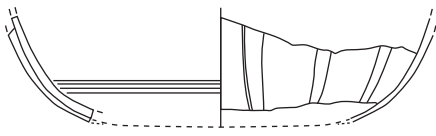

5



6



6 bis

Fragments de bols de costelles Isings 3



7

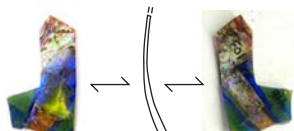

8

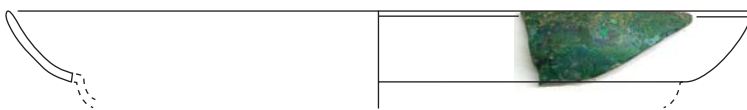

9

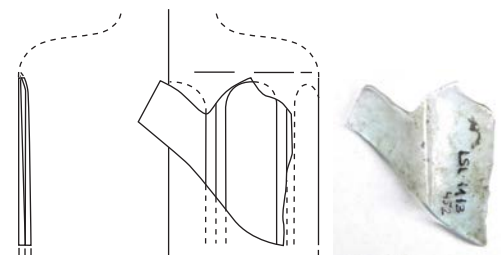

11

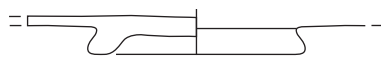

10

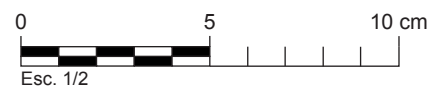
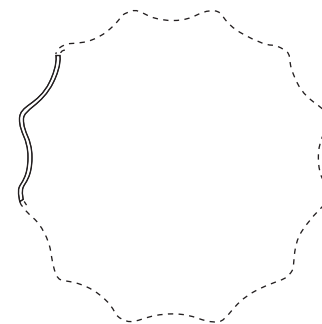

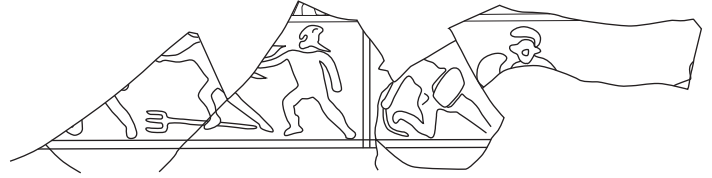
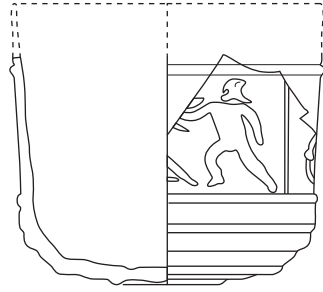

12

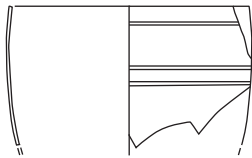
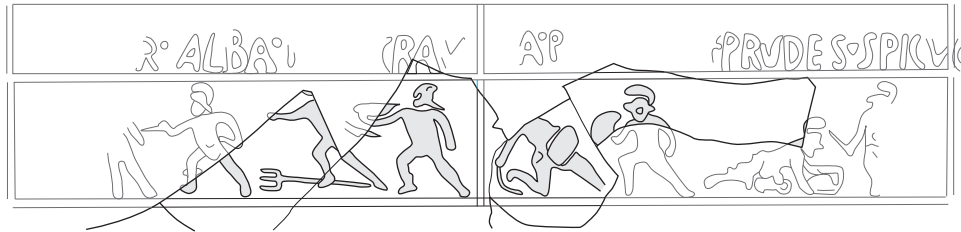
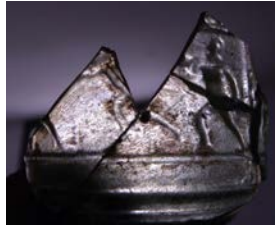

13

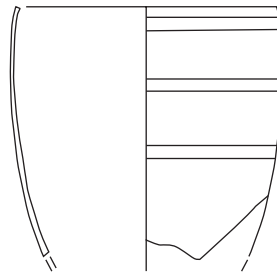
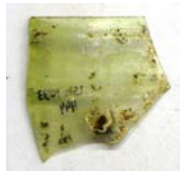

14

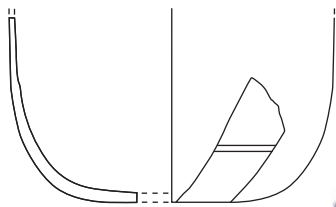

15

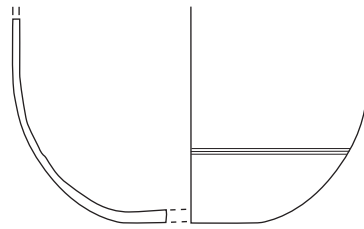
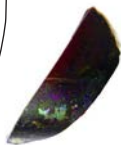

16

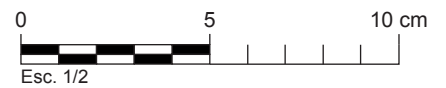

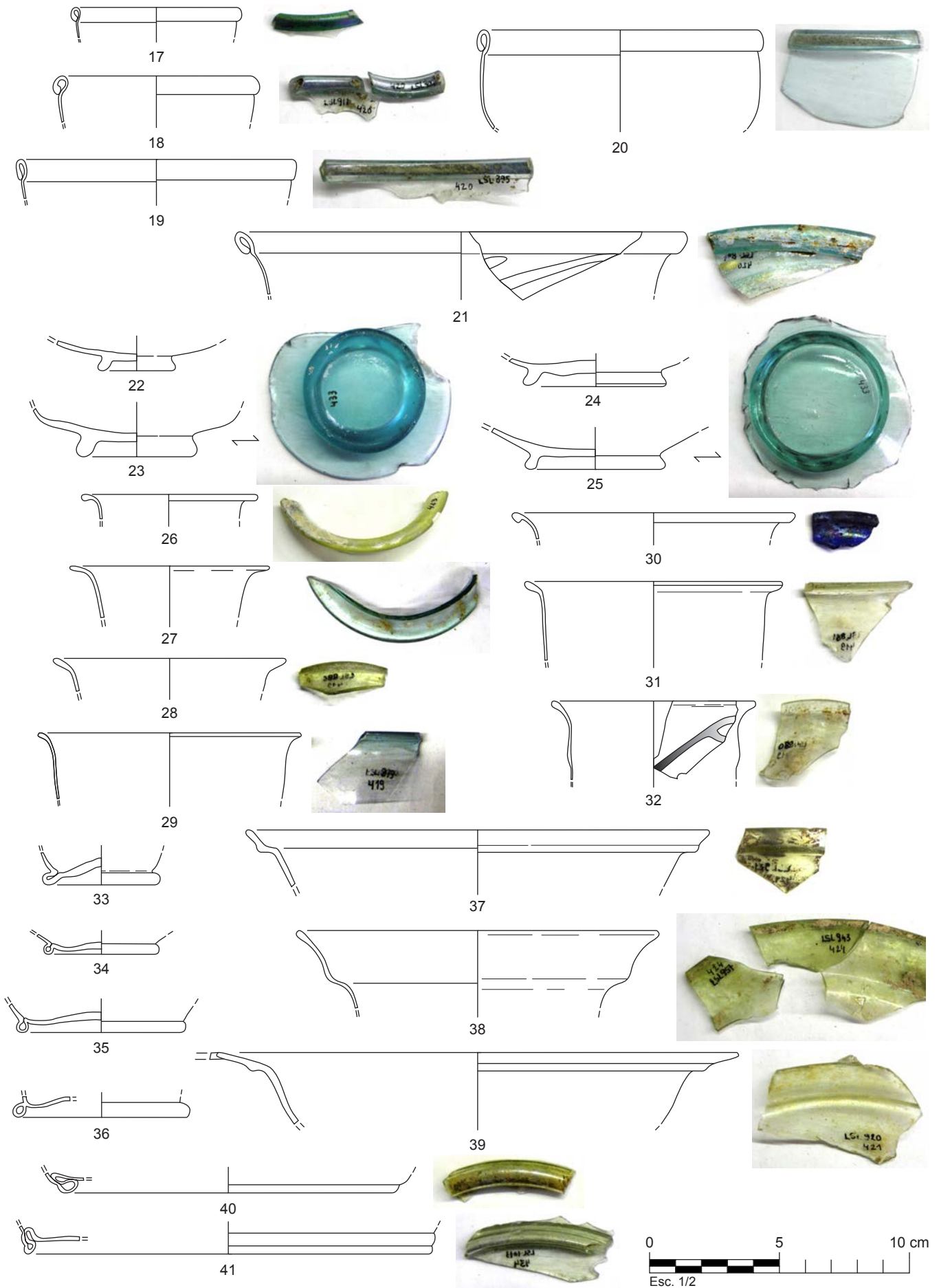

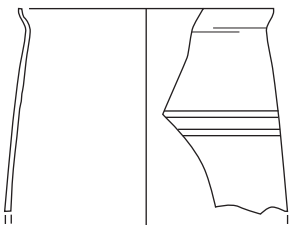

42

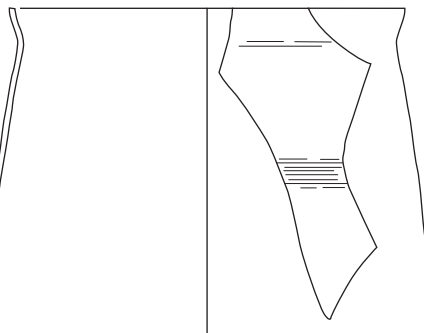
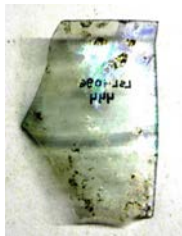

44

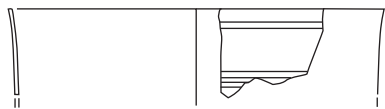

43

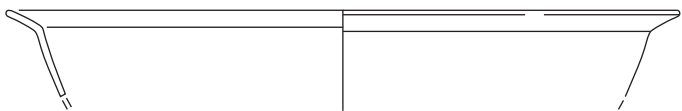

45



46

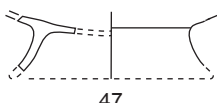

47

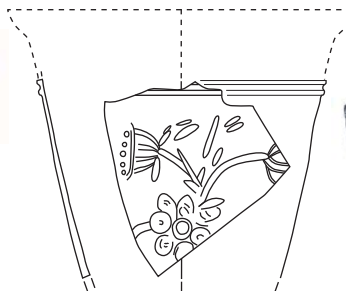

48



A. Fotografia de Joan Vilatobà  
AHS-Clixé CL03995

49

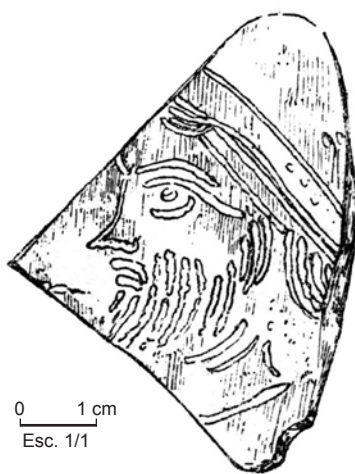

0 1 cm  
Esc. 1/1

B. Dibuix de Josep Gudiol  
Els Vidres Catalans 1936

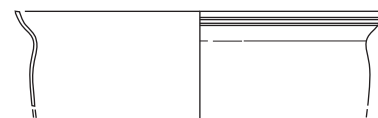

50

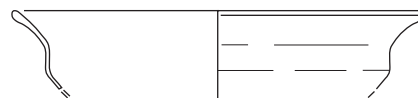

51



52

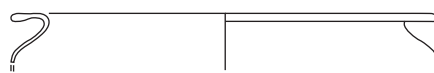

54

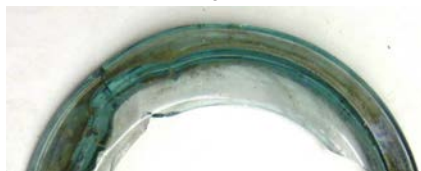

53

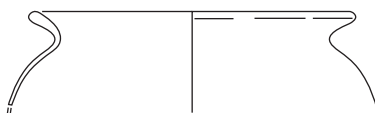

55



0 5 10 cm  
Esc. 1/2



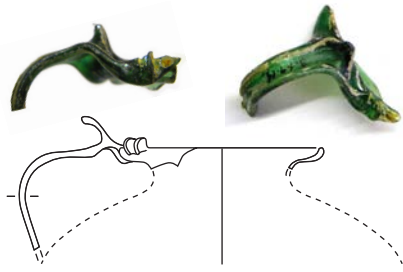

56

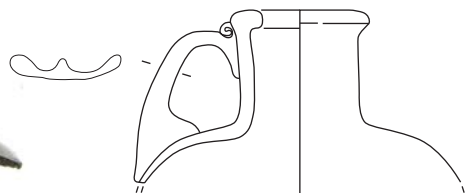

58

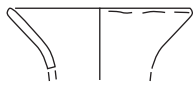

57

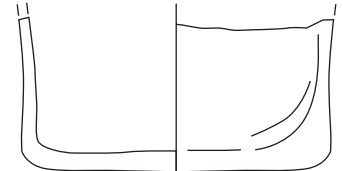
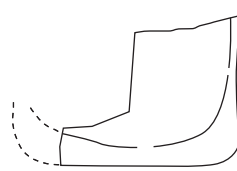

59

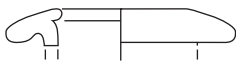

60

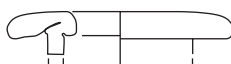

63

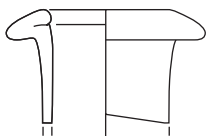

61



64



62

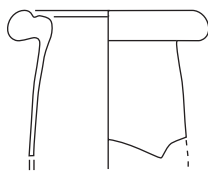

65



66



67

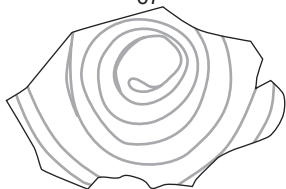

68

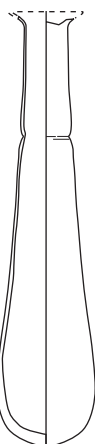
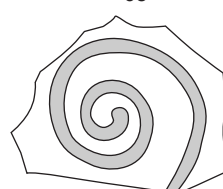

69

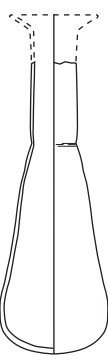

70

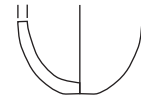

71



72

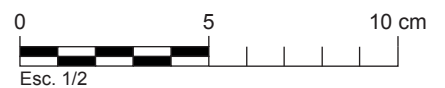

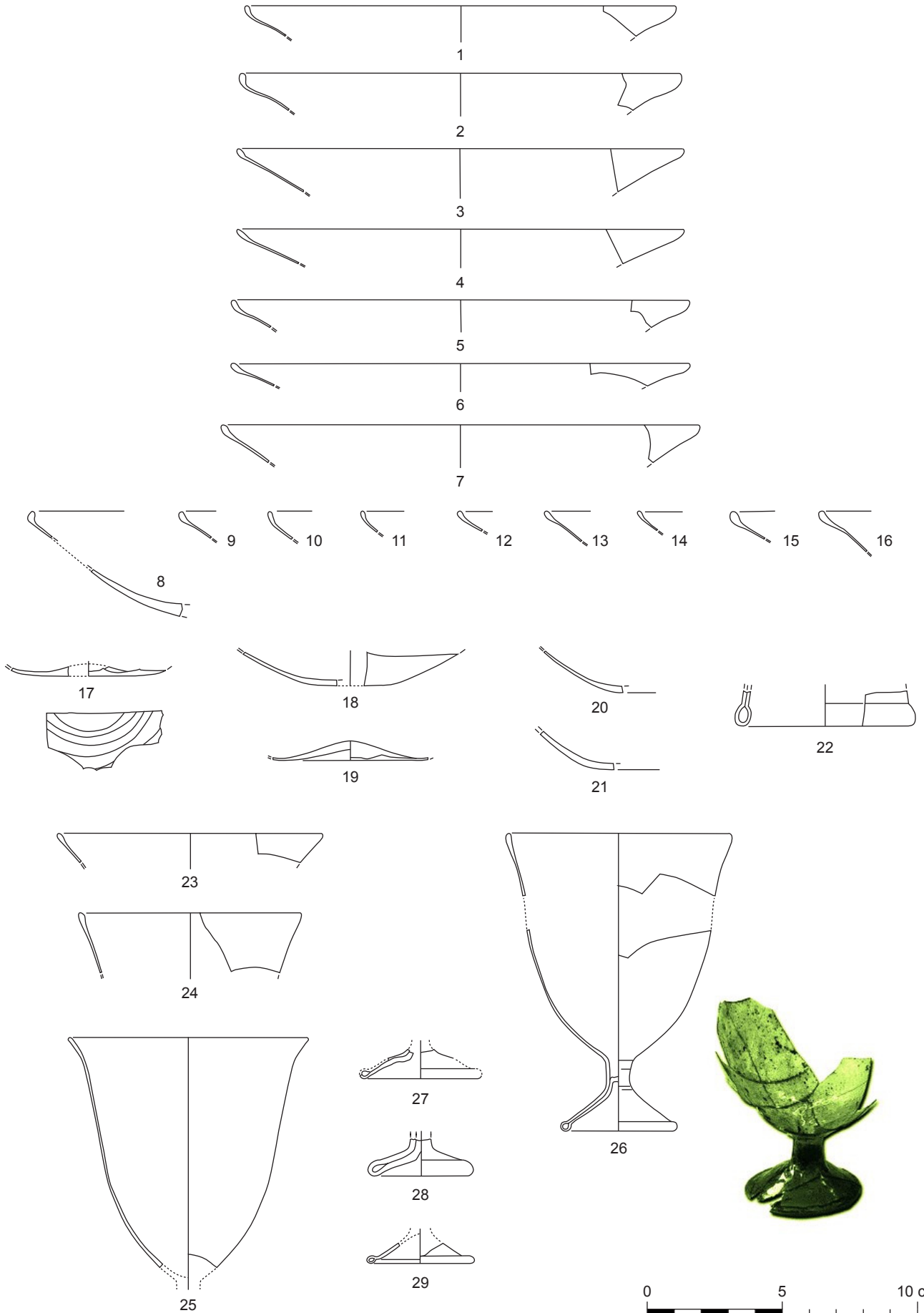

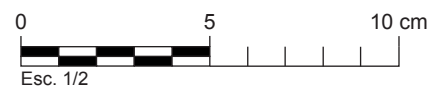
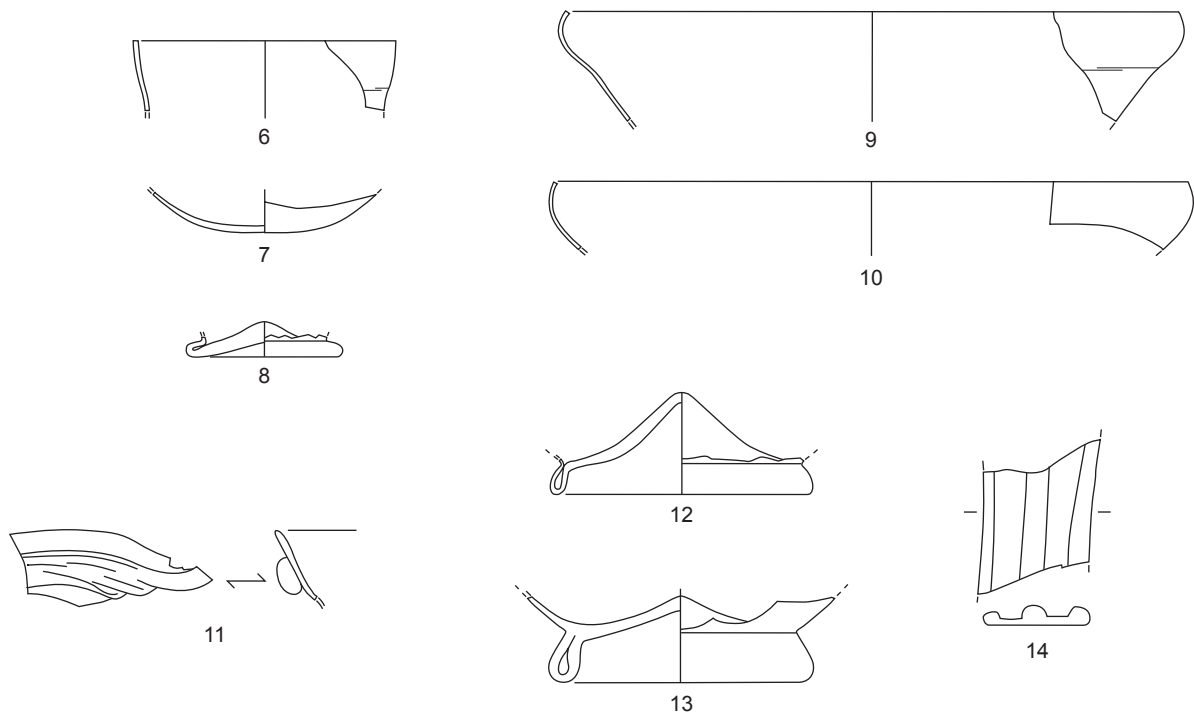
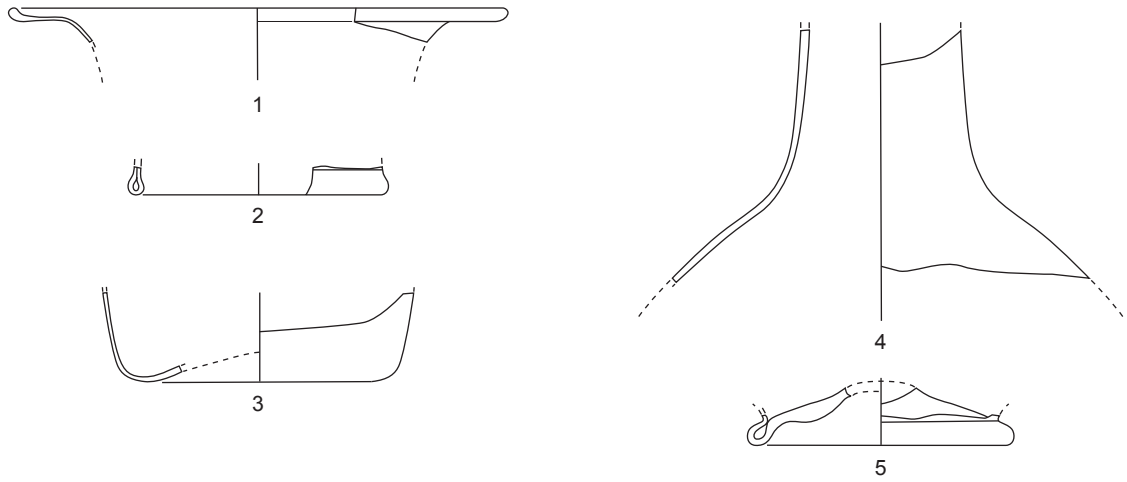

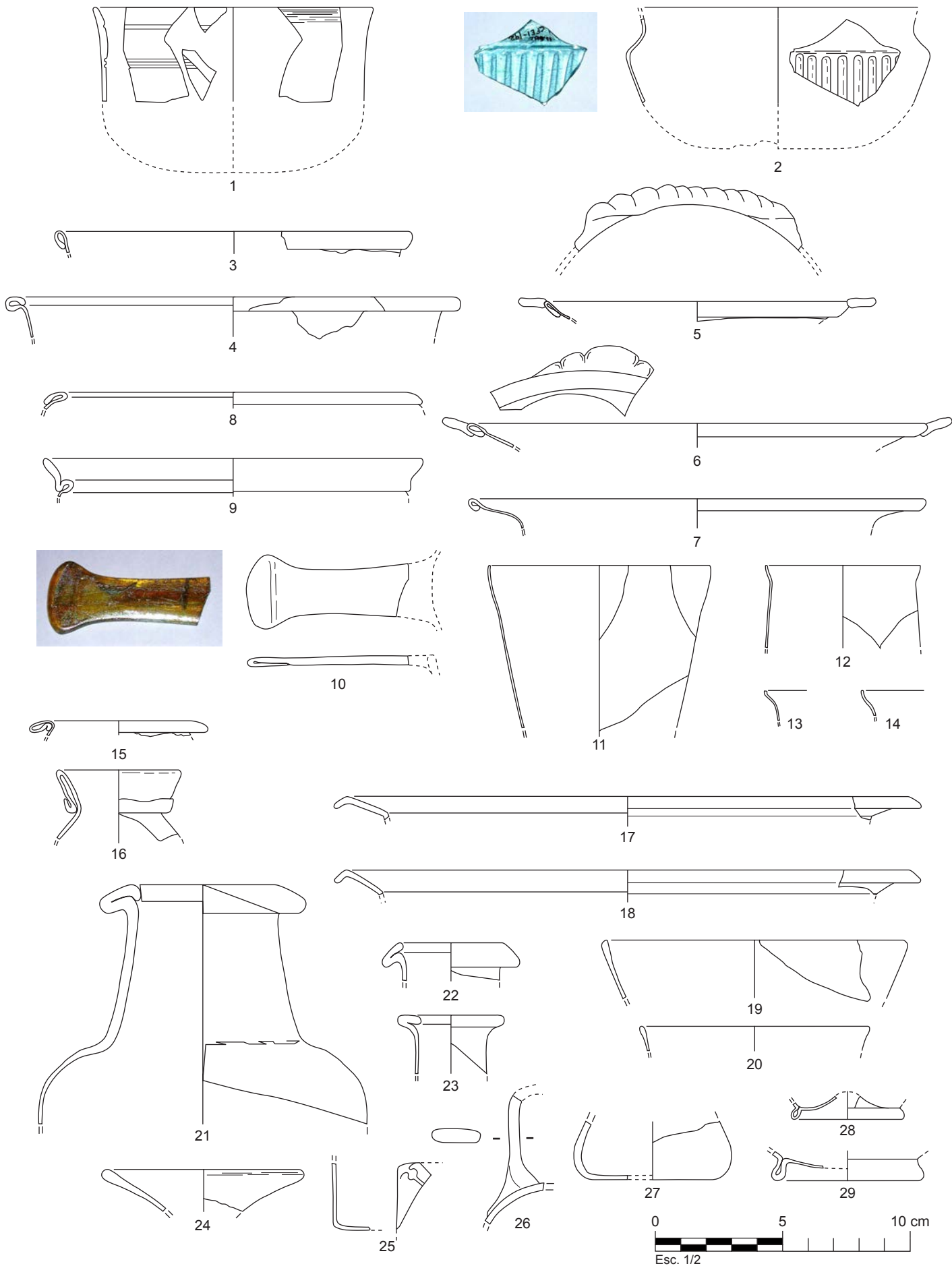

E.40



E.43

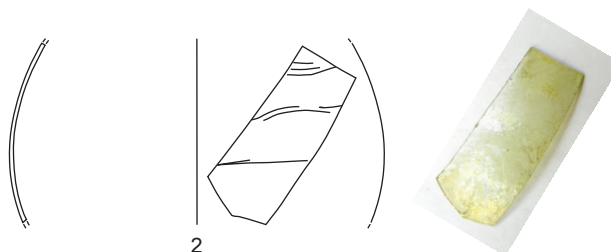

E.106

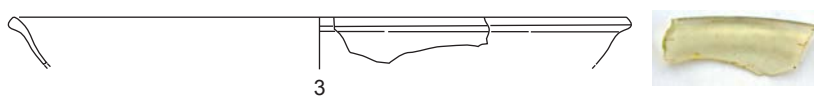

E.109

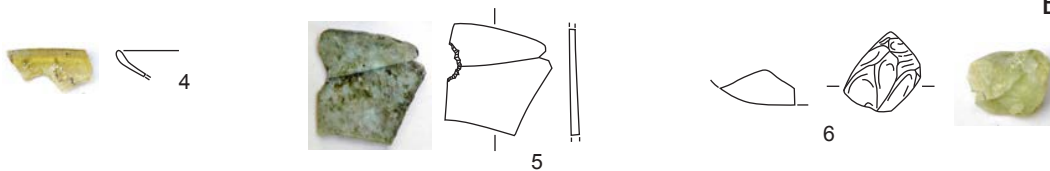

E.136



E.196



E.204

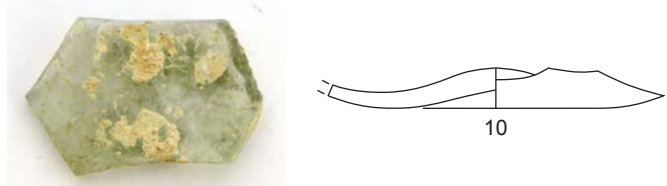

E.215

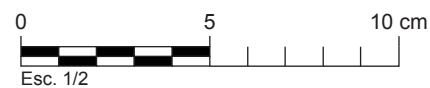

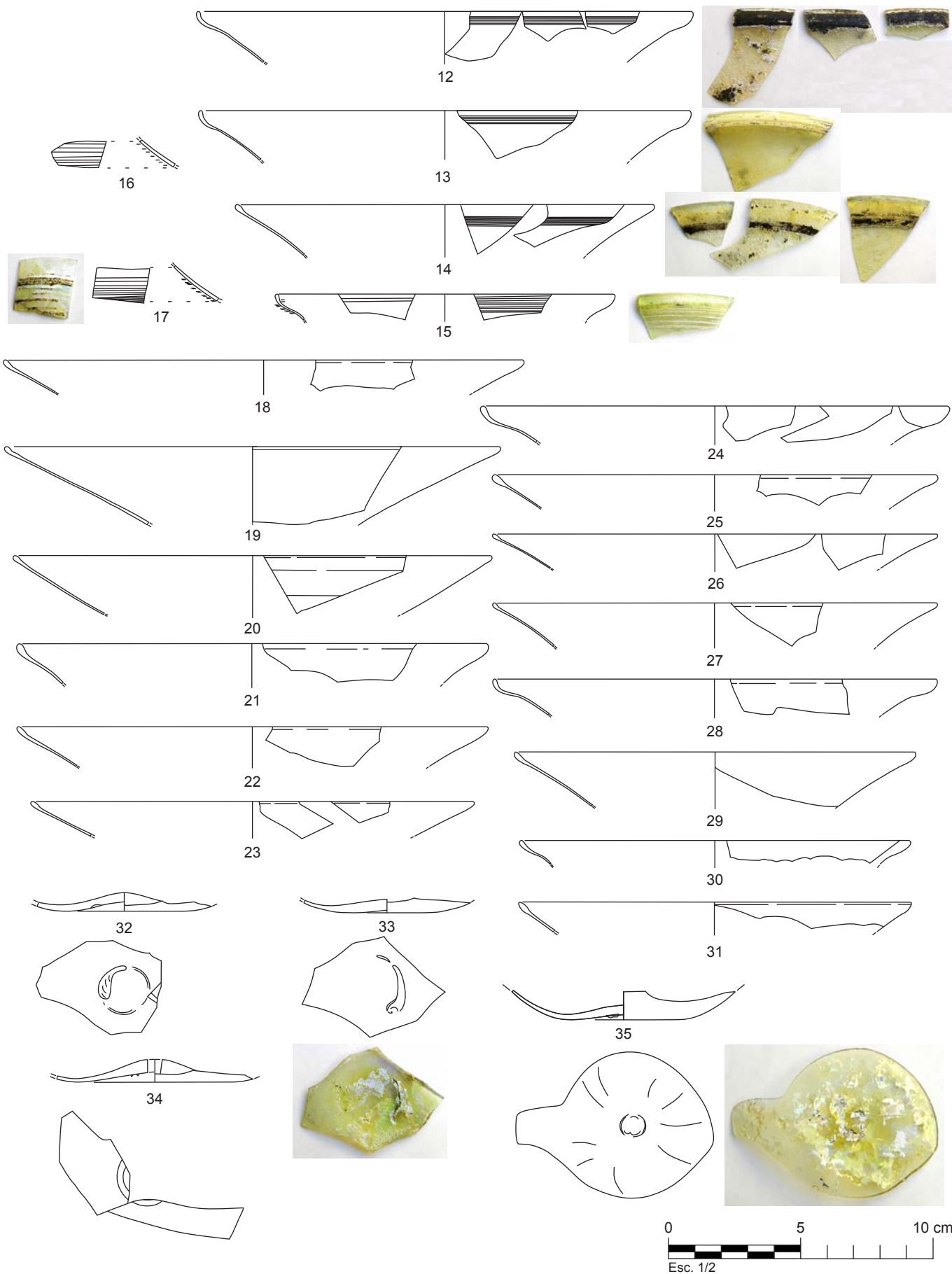

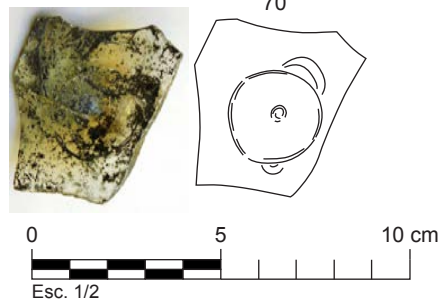
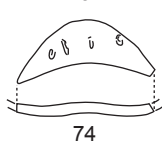
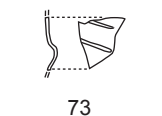
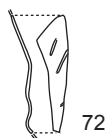
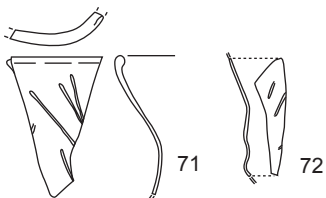
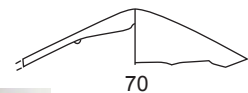
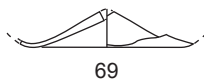
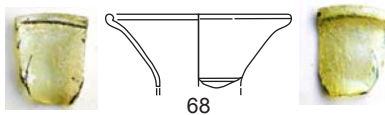
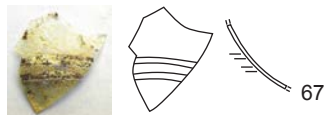
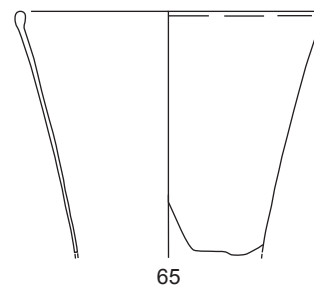
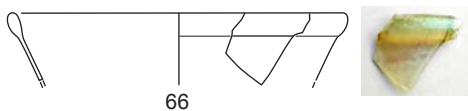
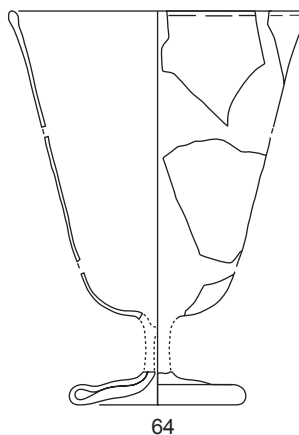
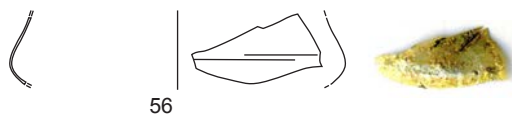
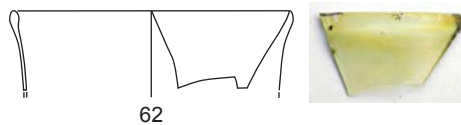
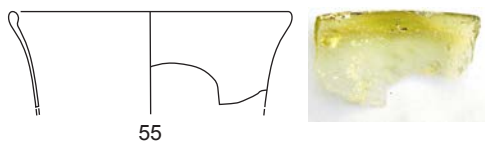
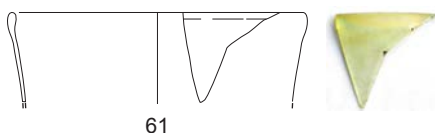
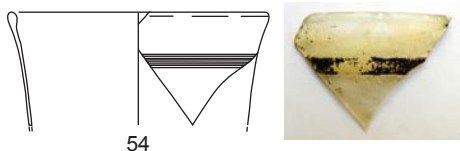
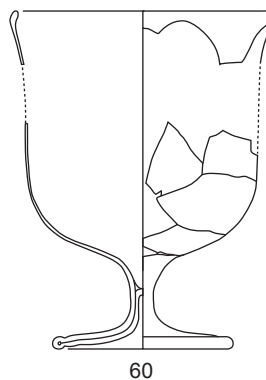
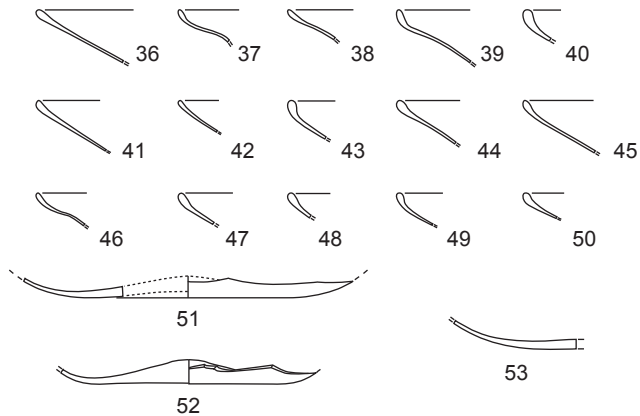

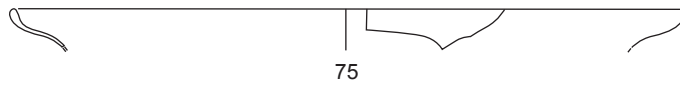

75



E.241

E.265



76

E.275



77

E.283



78

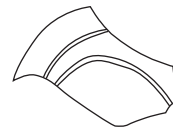

E.287



79

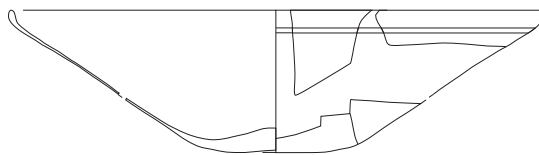

80



E.350



81

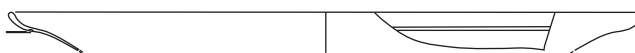

82

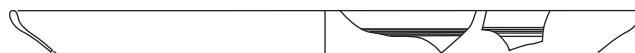

83

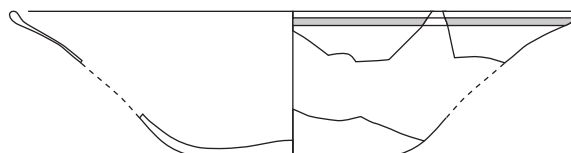

84

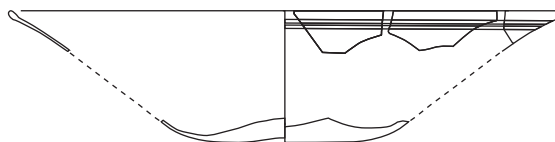

85



86



87



88

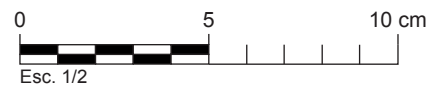
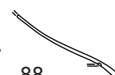



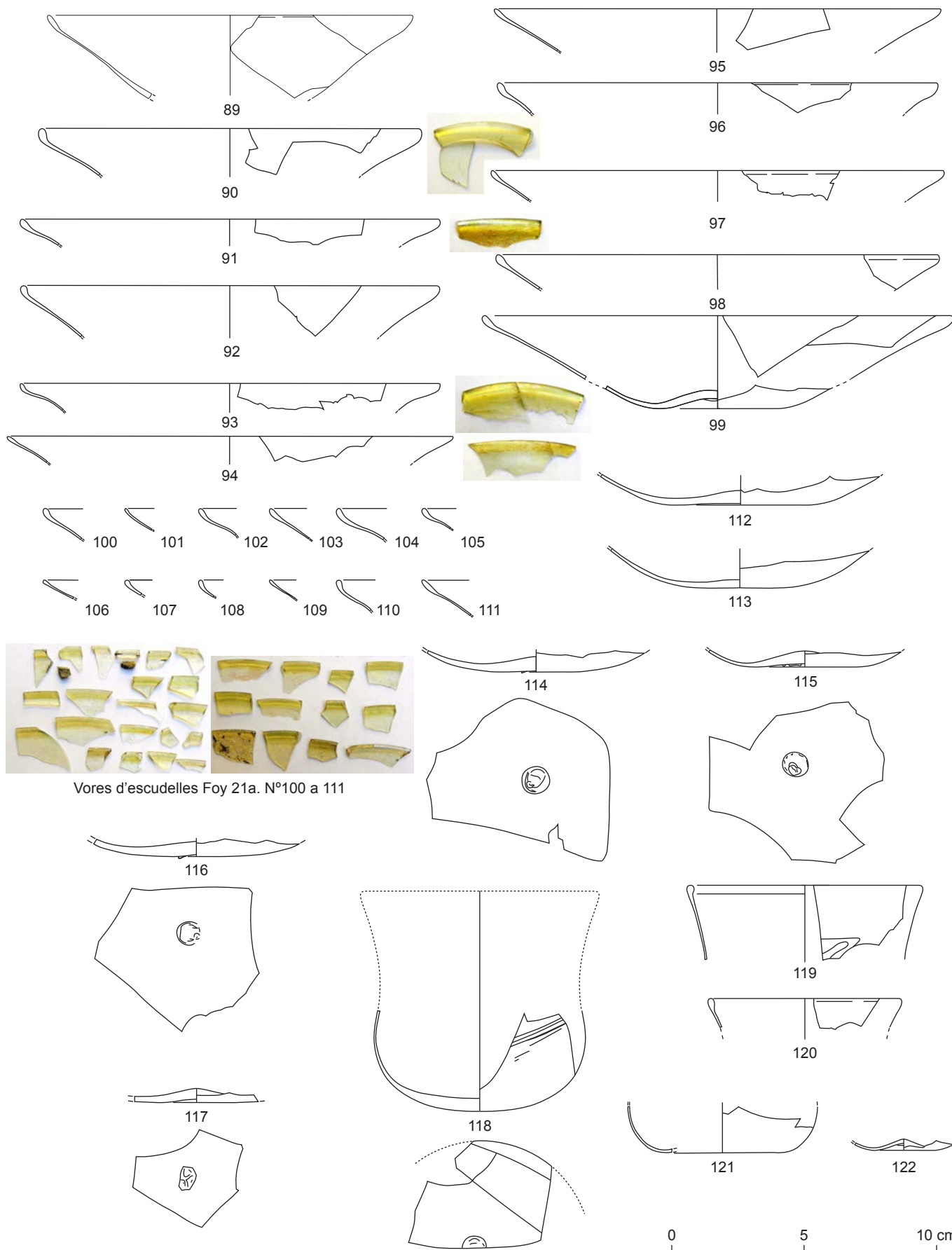

Vores d'escudelles Foy 21a. N°100 a 111





E.427

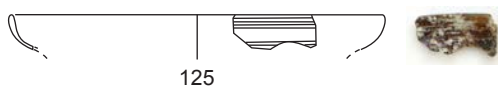

E.451



E.631

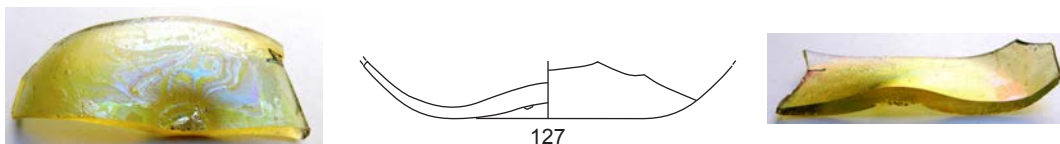

E.637

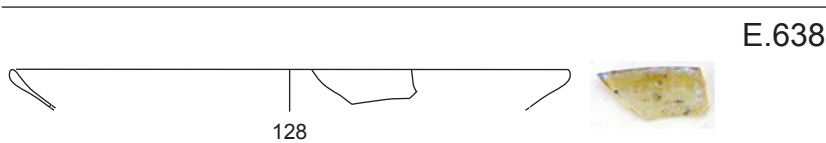

E.638



E.641

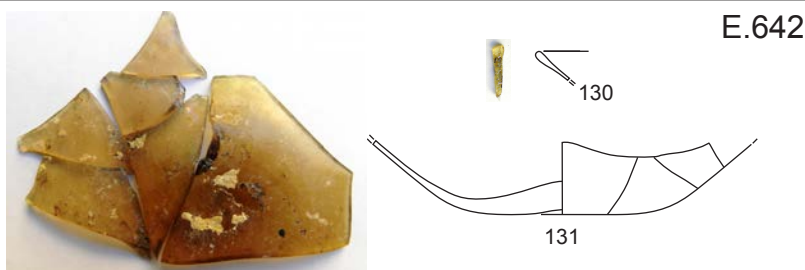

E.642

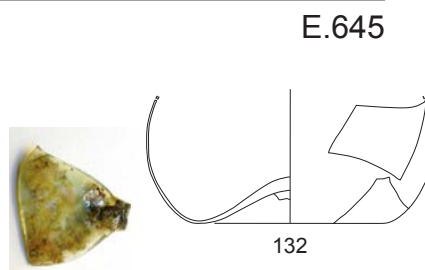

E.645

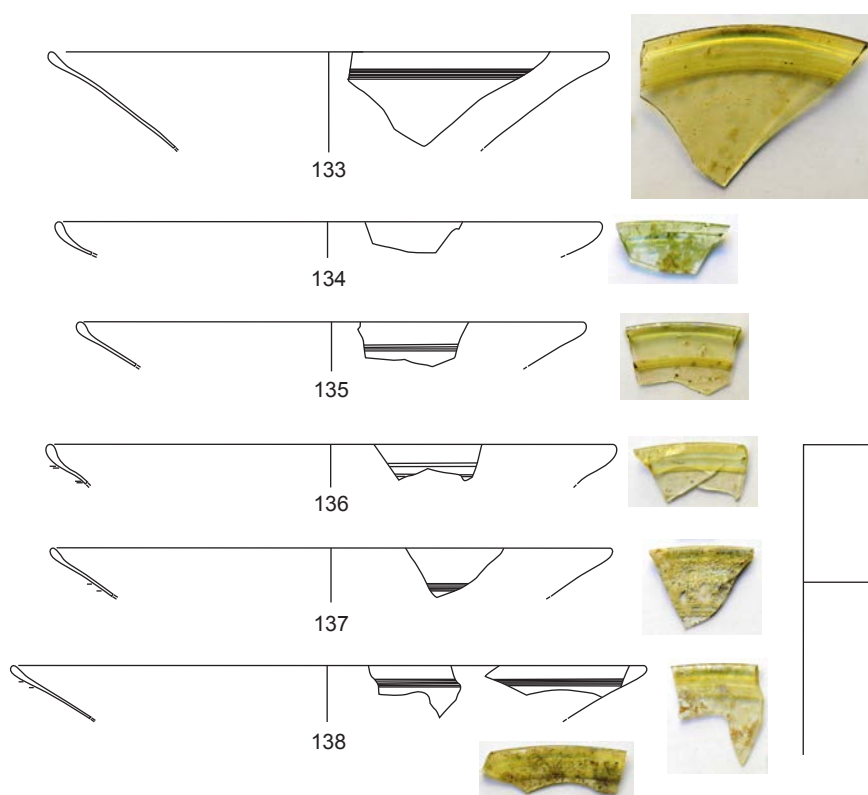

E.653



E.655

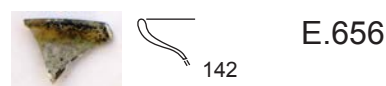

E.656

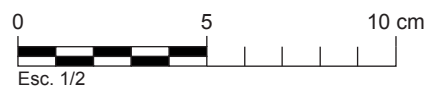

E.659

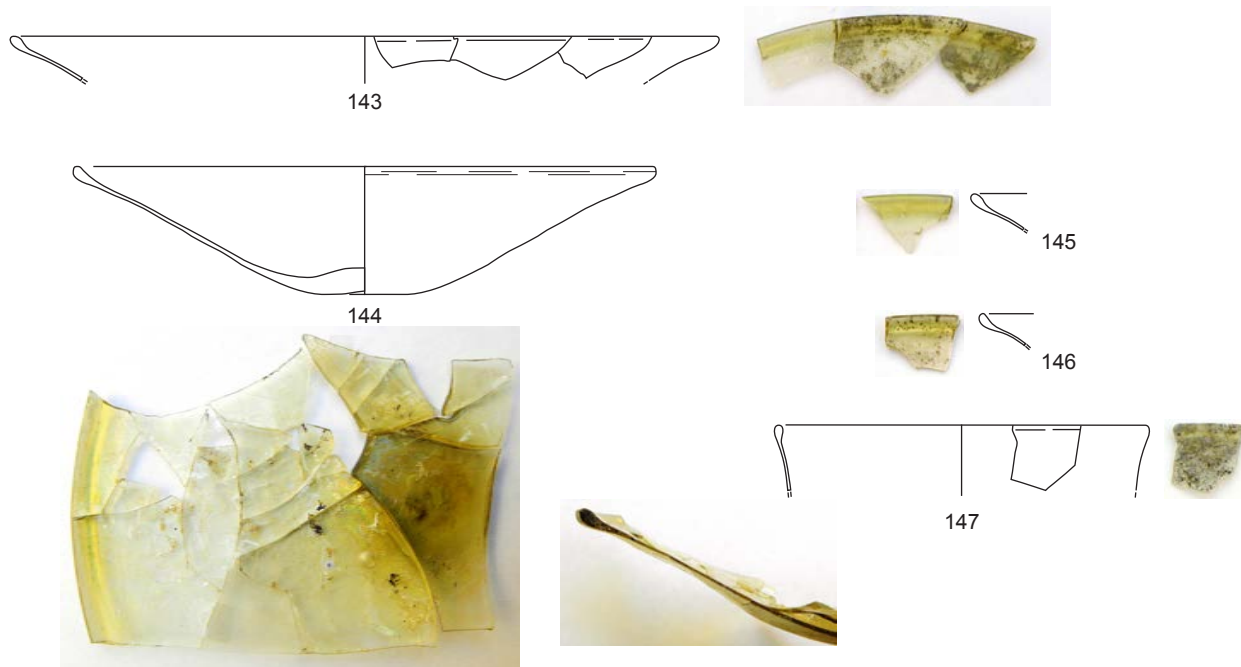

E.660

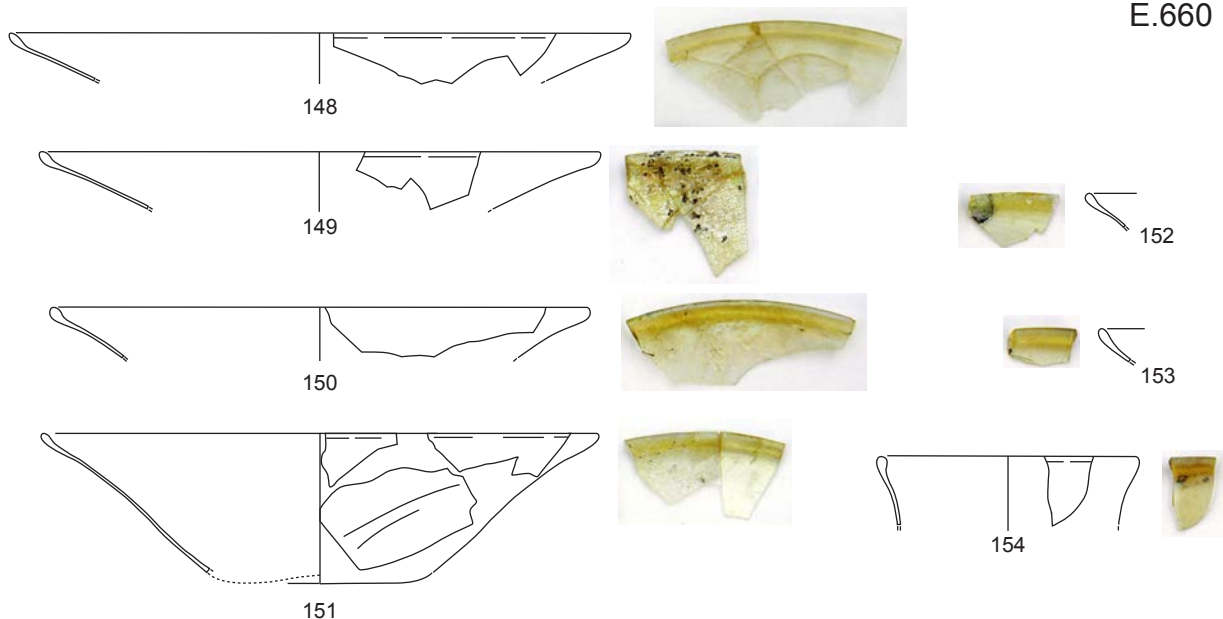

E.661



E.663

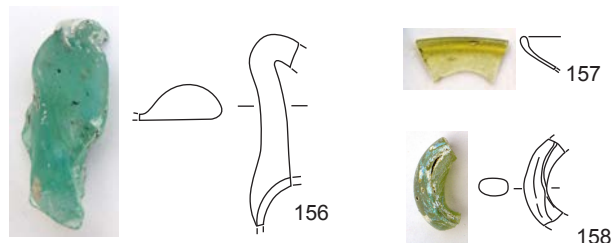

E.694

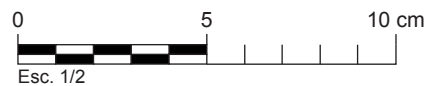
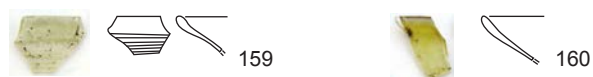

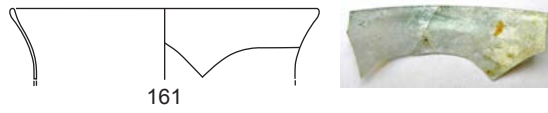

E.72

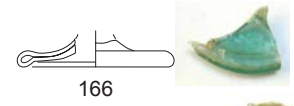
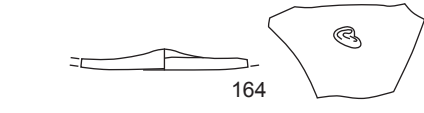
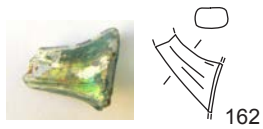

E.85

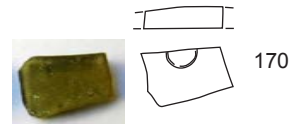
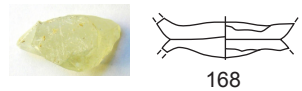
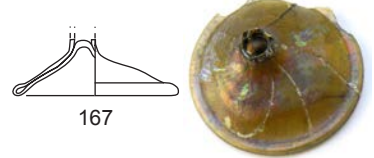
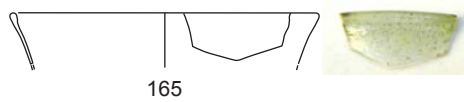

E.102

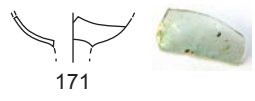

E.120

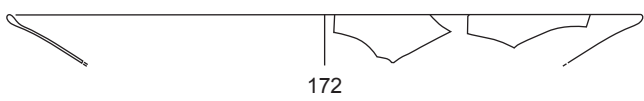

E.135

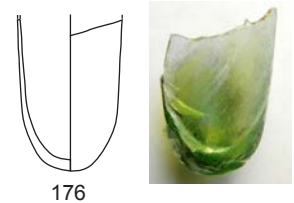

E.199

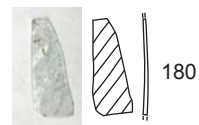
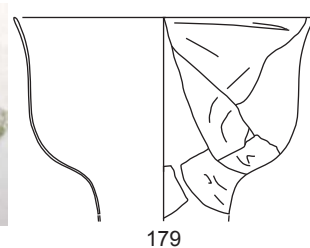
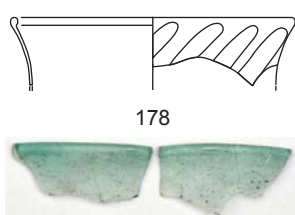
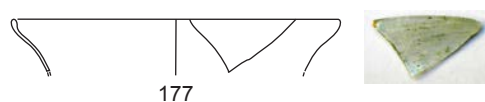

E.201

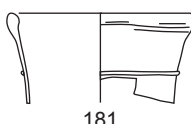

E.210



E.212

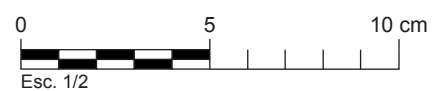

E.229



E.245

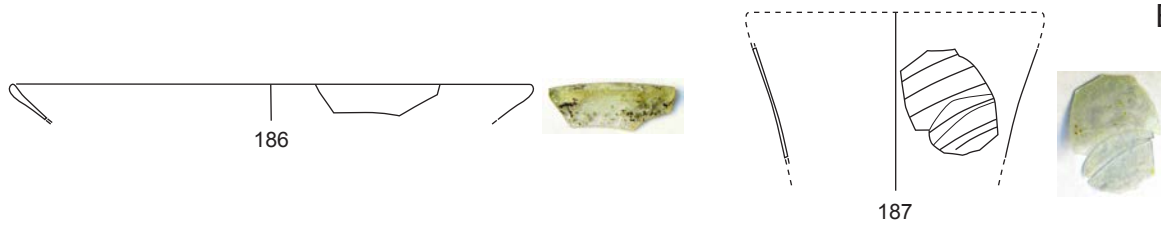

E.249



E.251

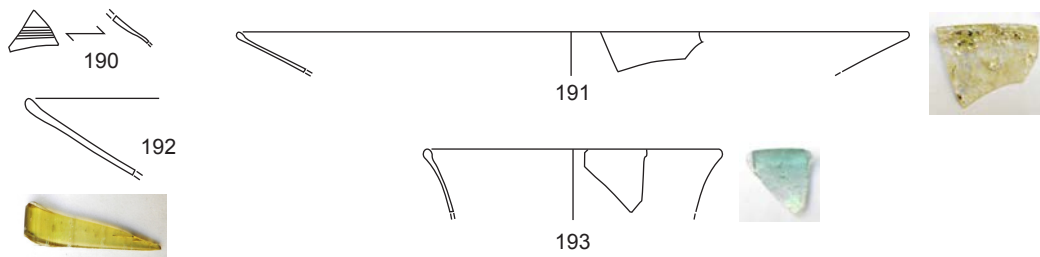

E.254

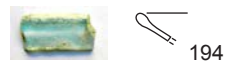

E.258

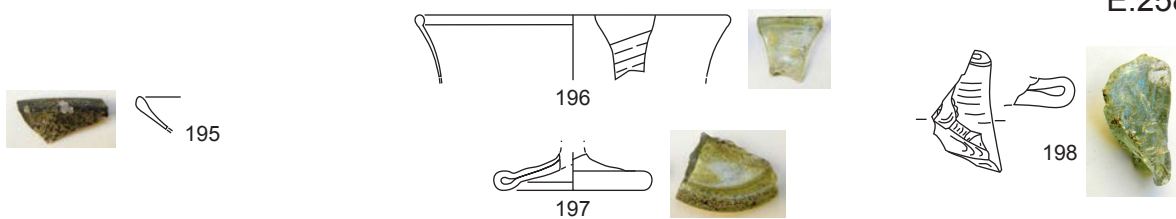

E.261

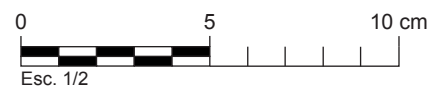
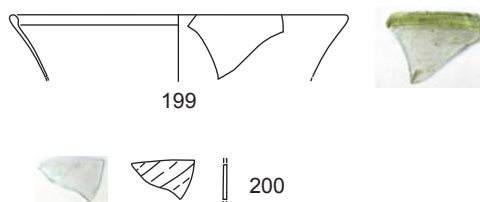

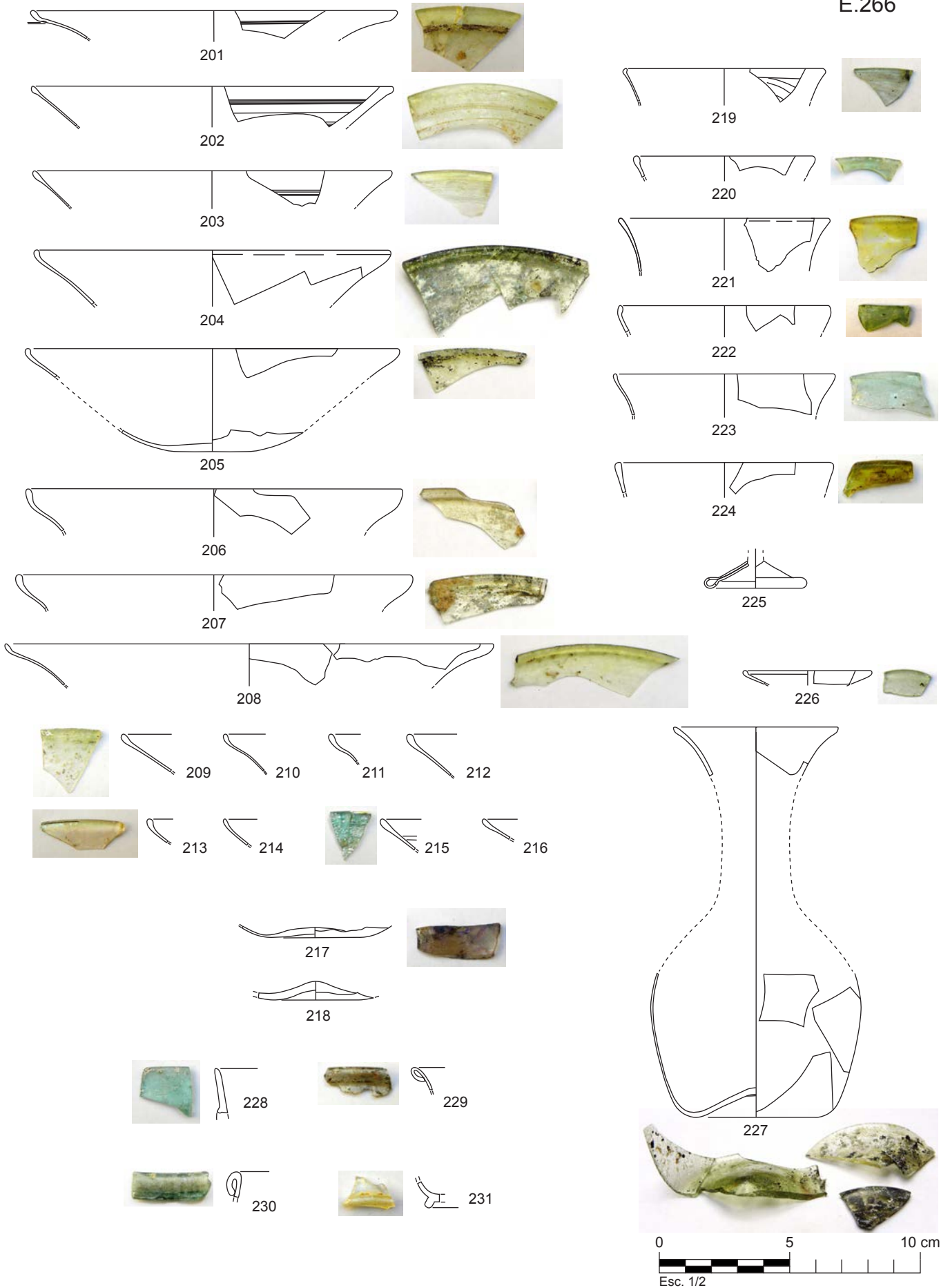

E.269

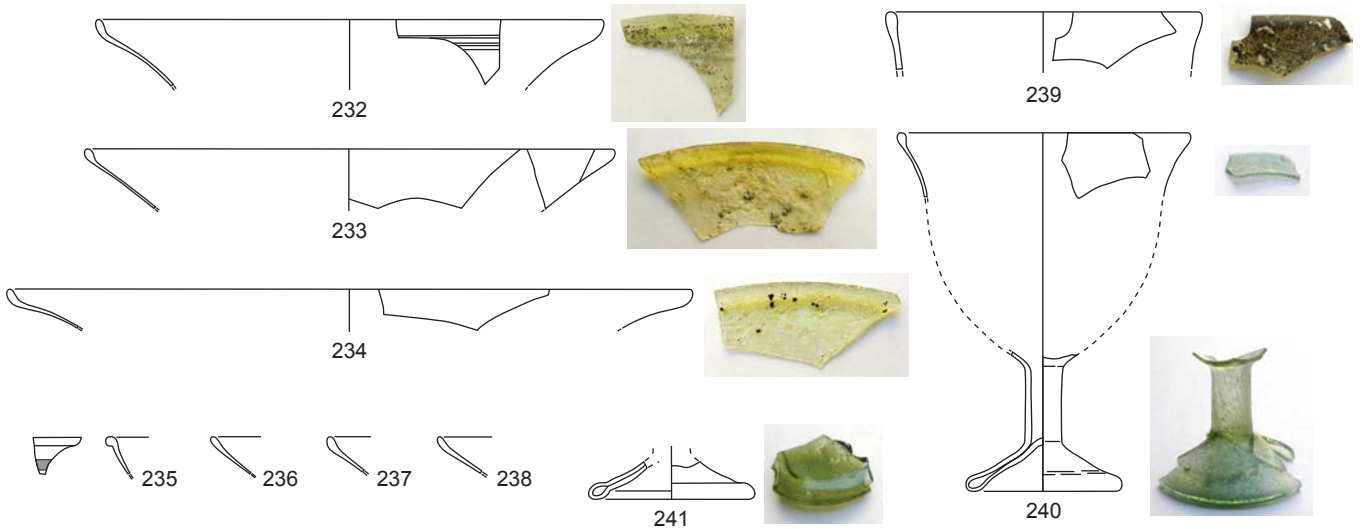

E.270

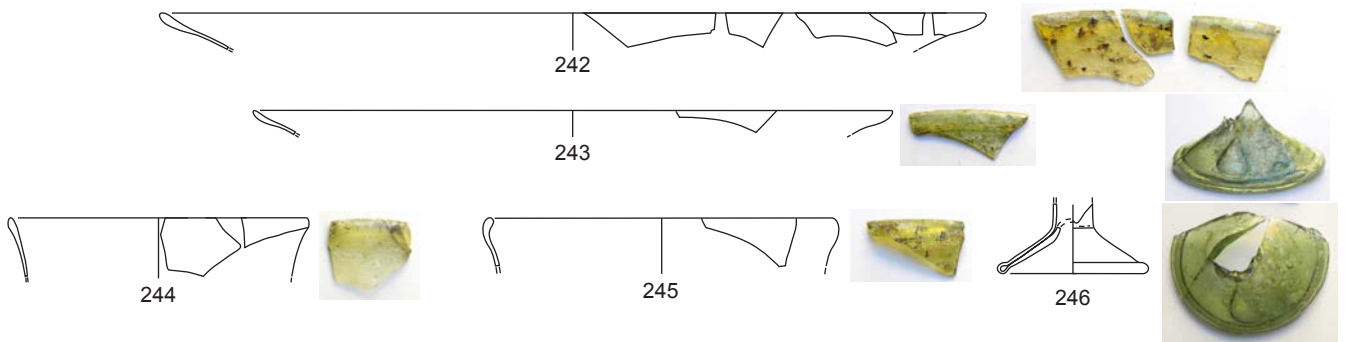

E.283

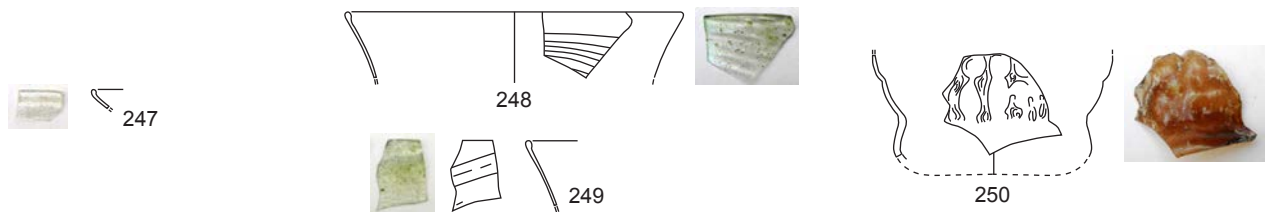

E.286

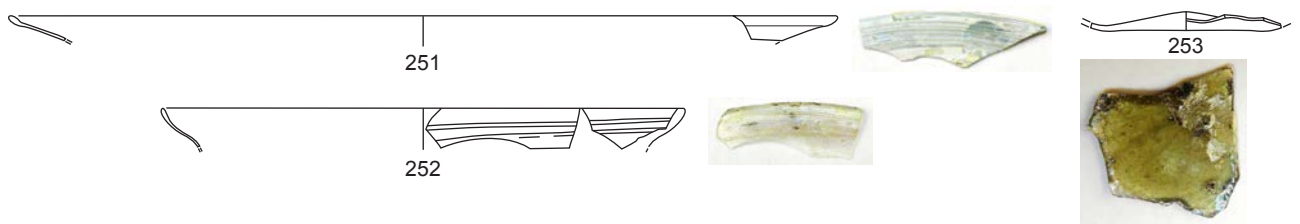

E.288

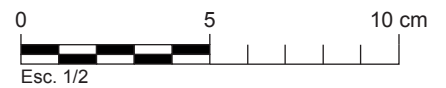
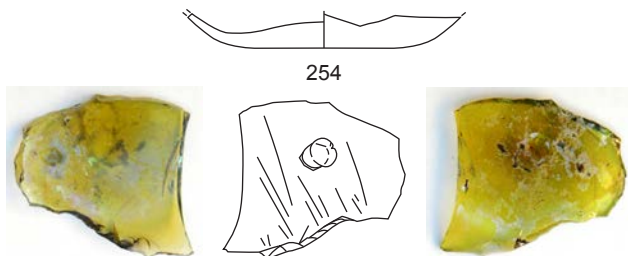

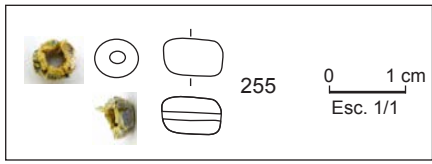

E.370

E.374



E.417



E.636

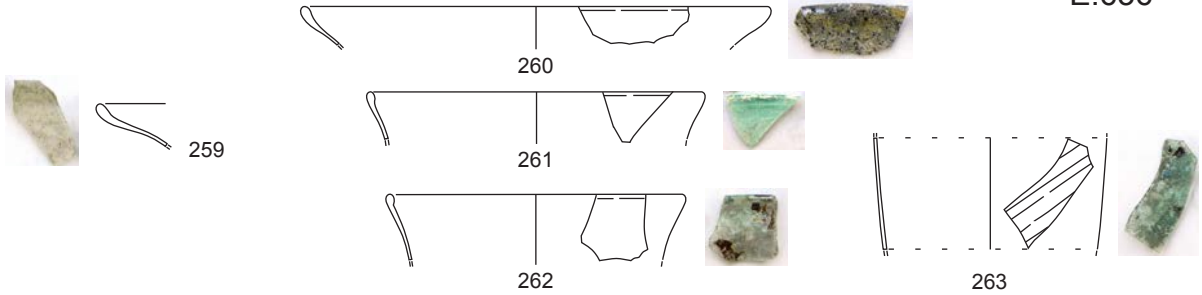

E.640

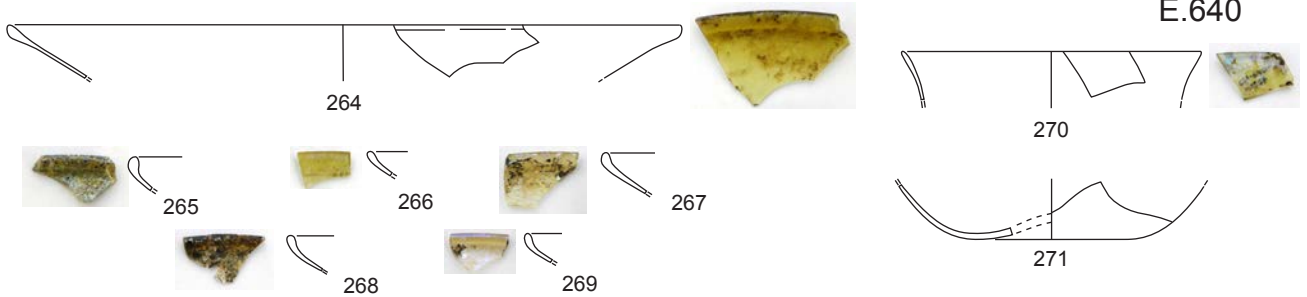

E.644

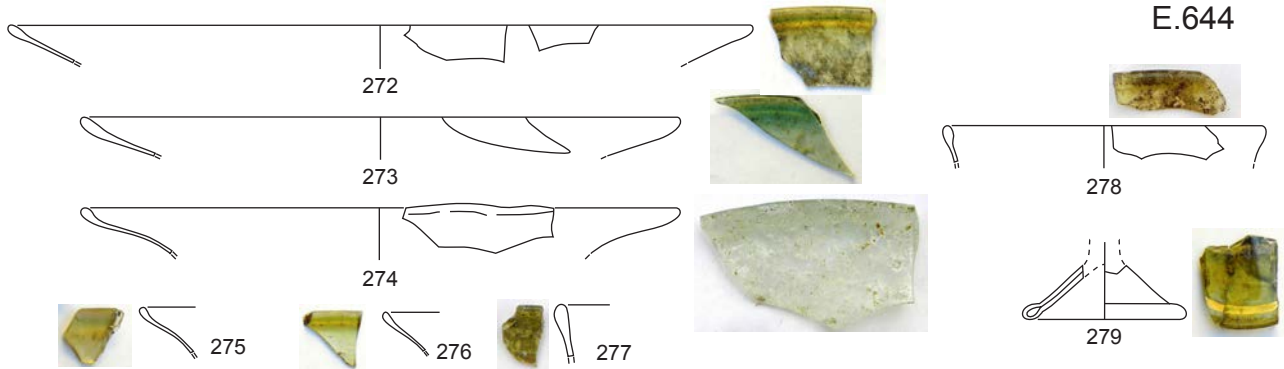

E.646



E.650

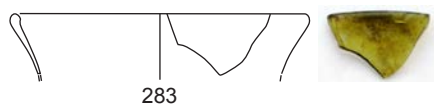

E.675

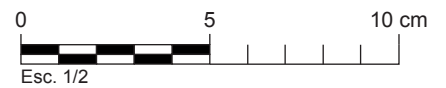



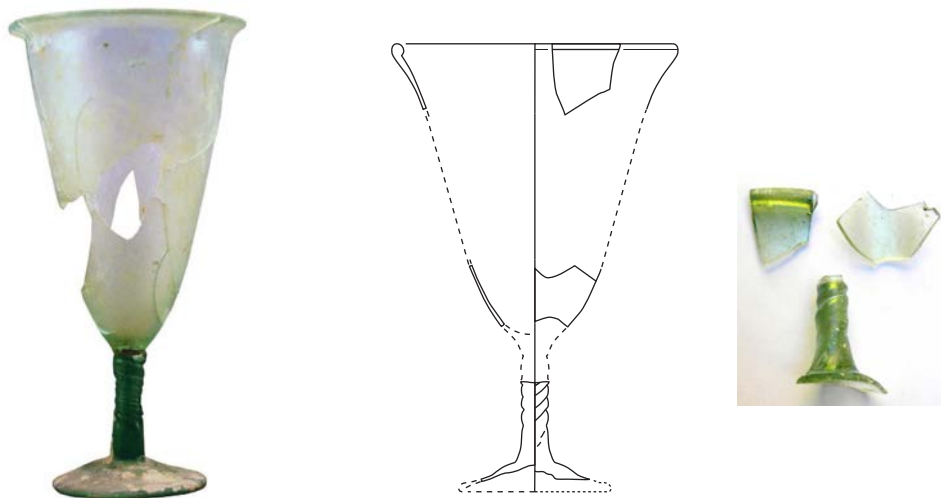
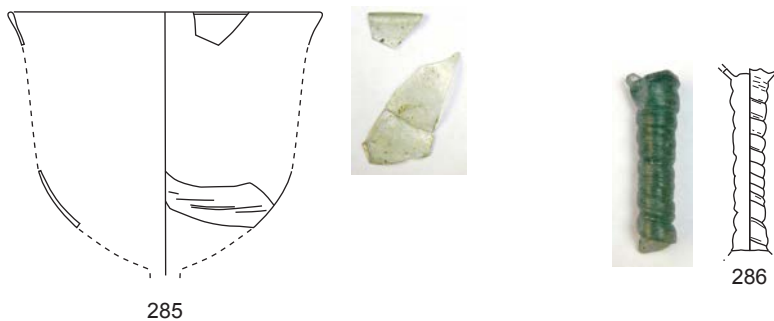

Necròpolis de Los Llanillos-Las Hontanillas  
(Villaverde y Pasaconsol, Cuenca)  
Fotografía Foy 2015, p.62, fig.1:7

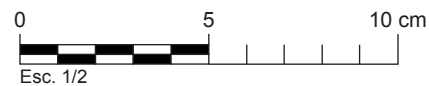
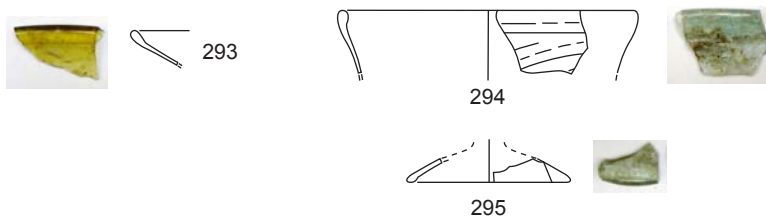
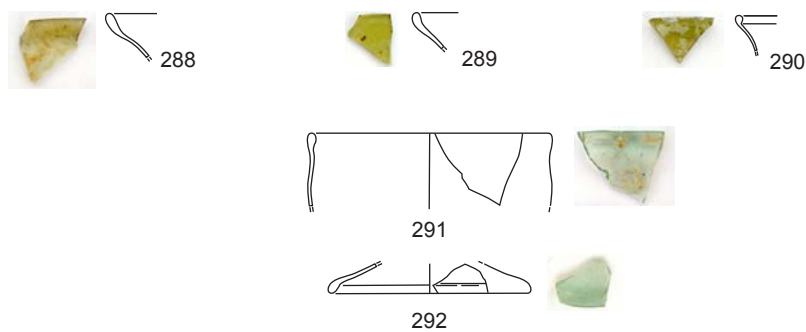

UE.23

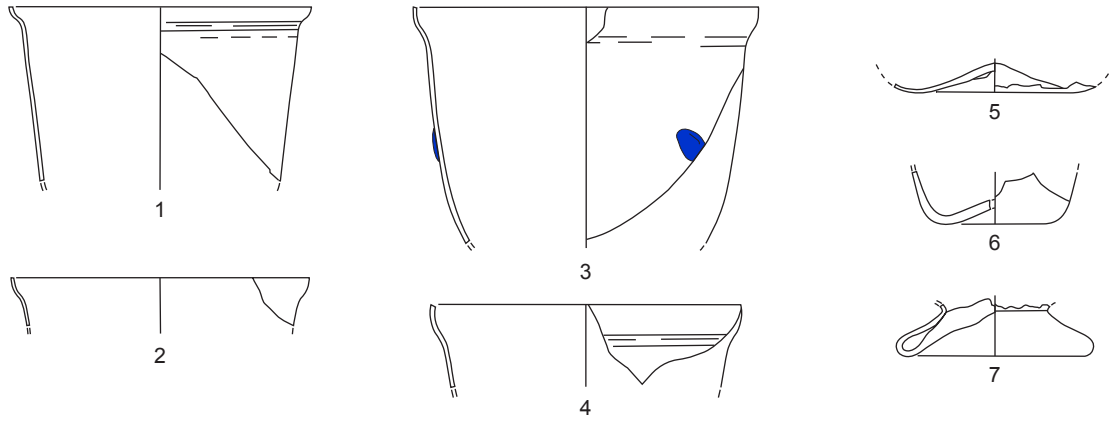

UE.43

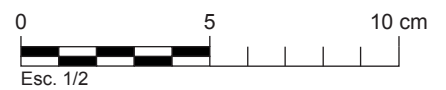
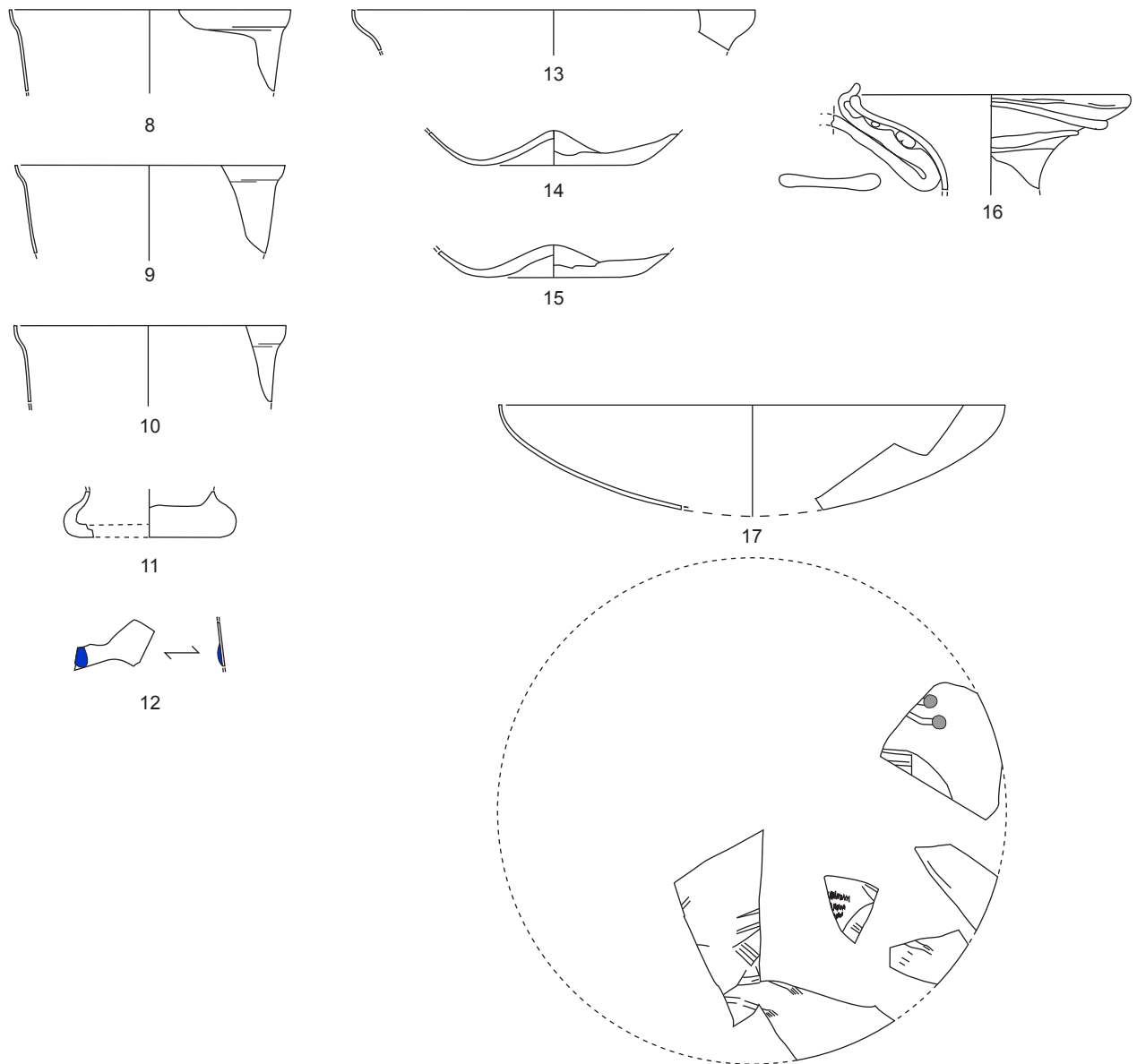

UE.810

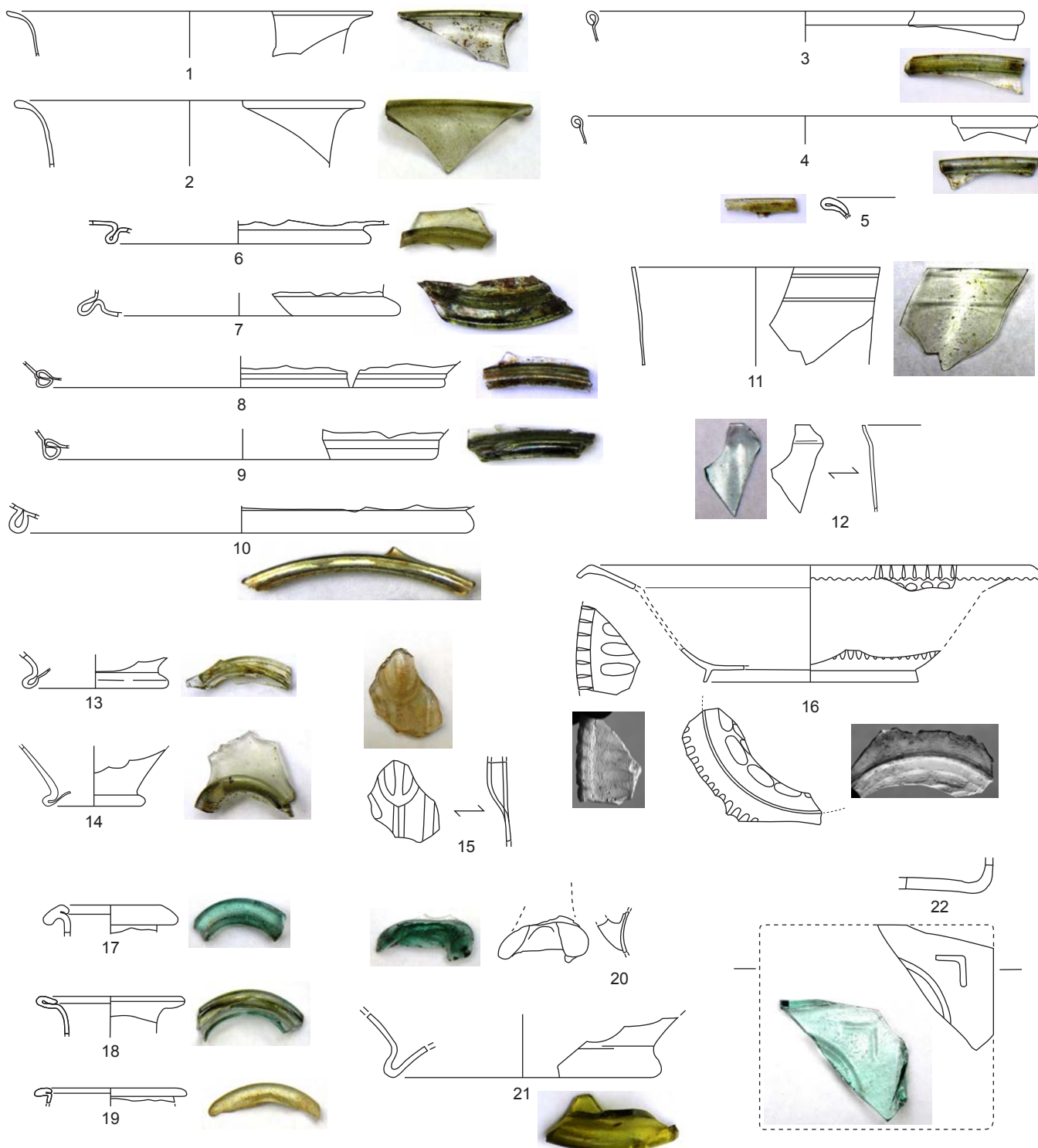

UE.1228

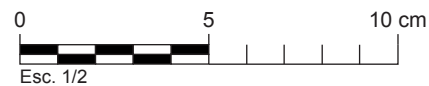
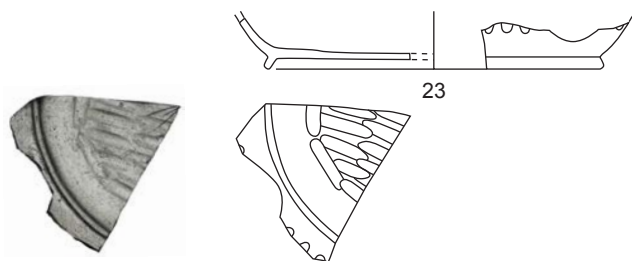

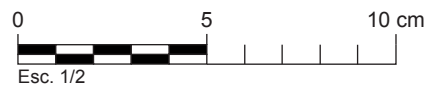
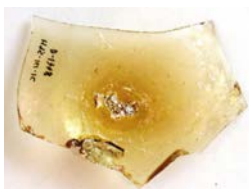
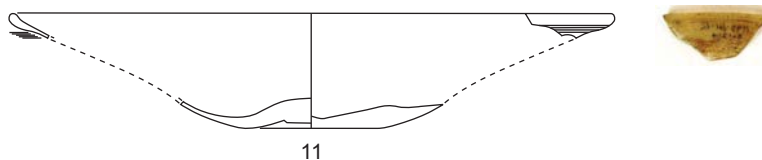
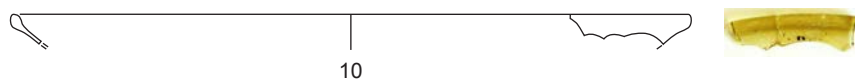
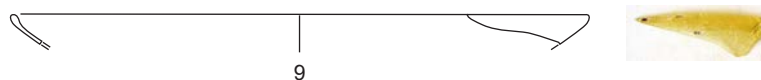
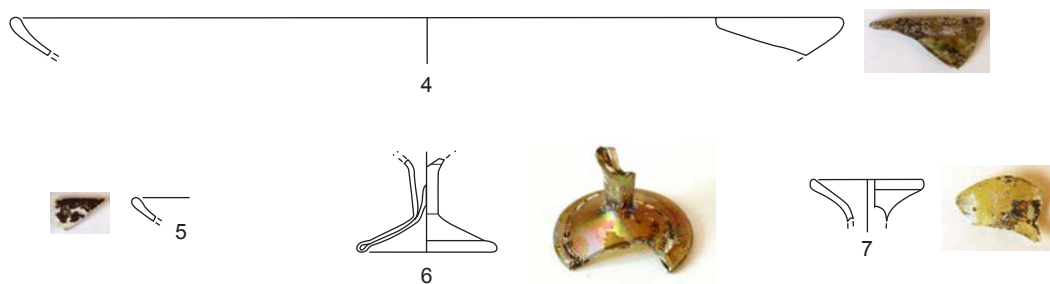
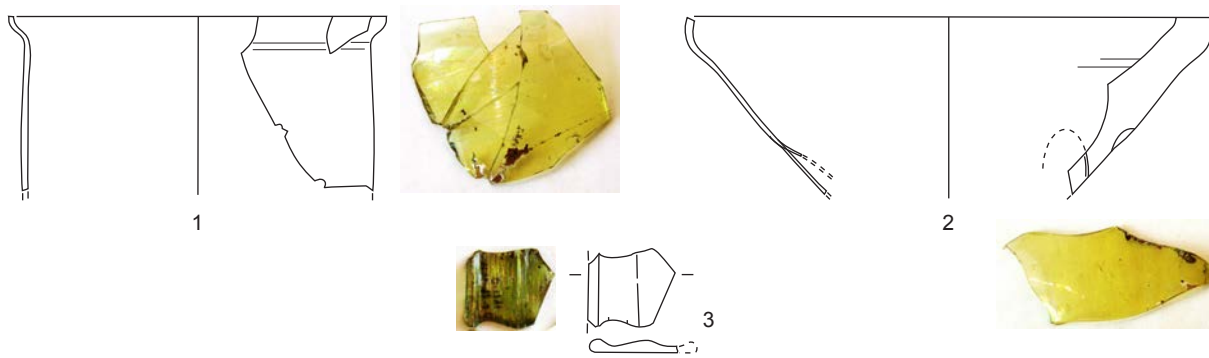

E.163

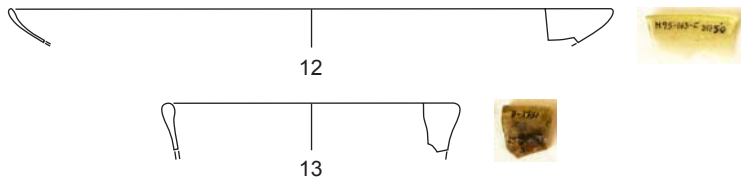

E.165



E.166

E.167

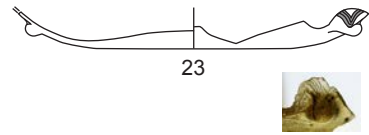
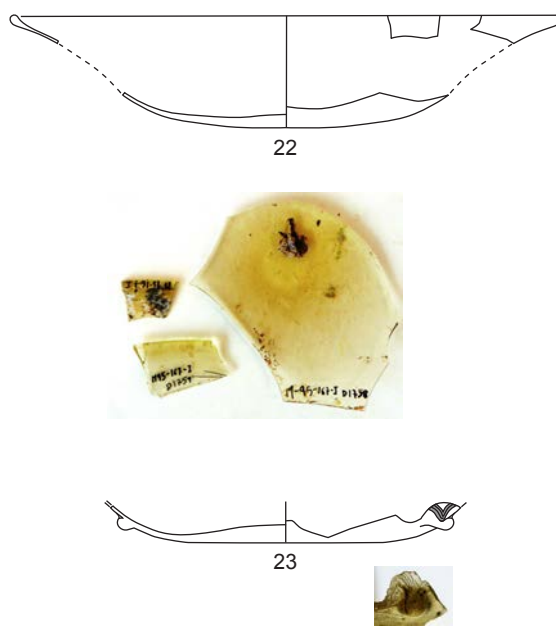
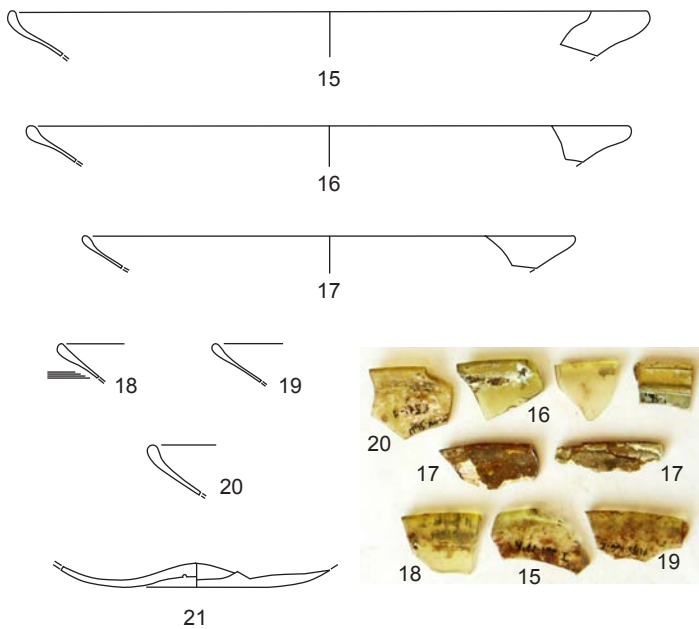

E.171

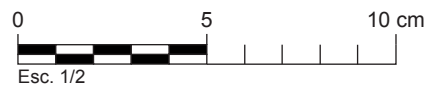
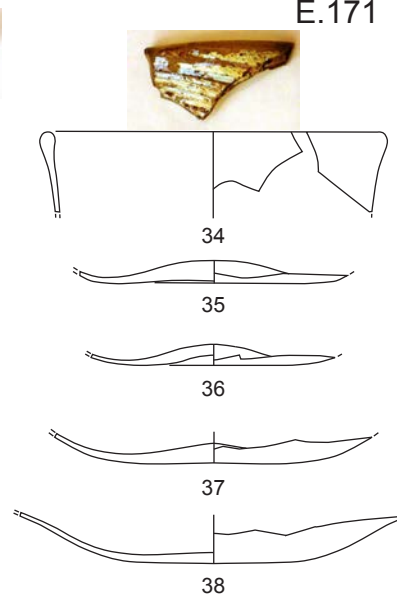
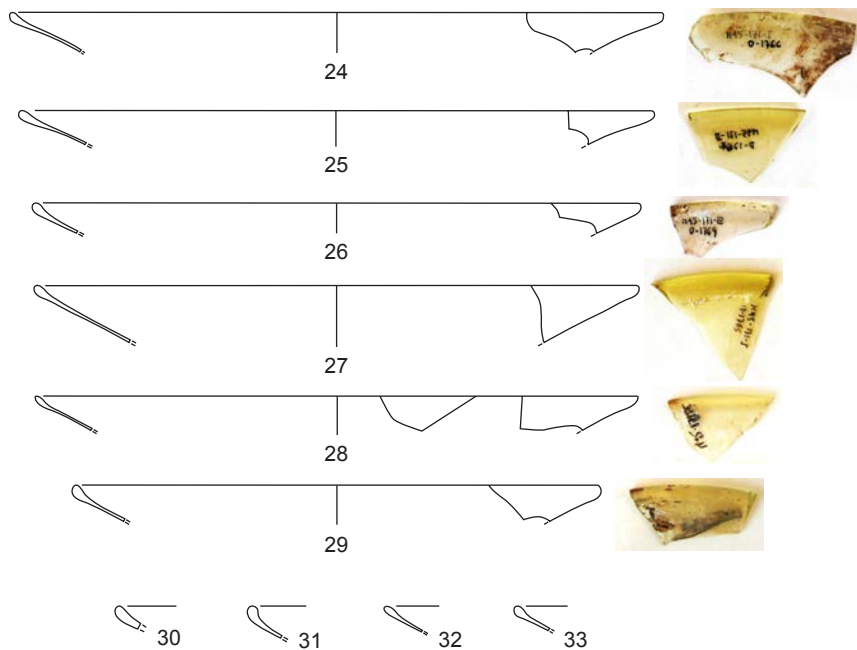

E.178

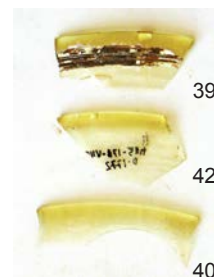
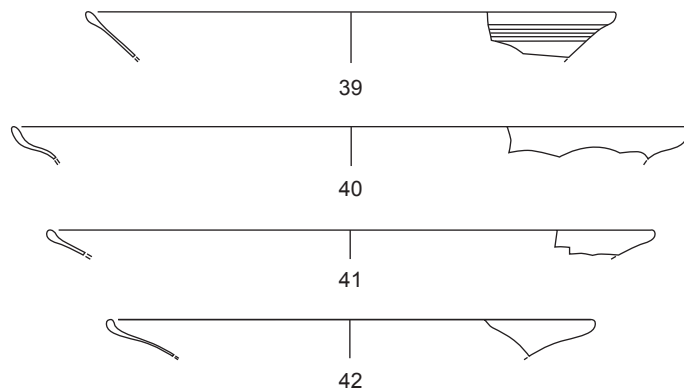

E.179

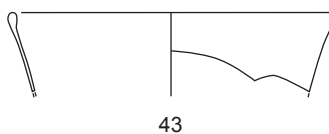

E.192

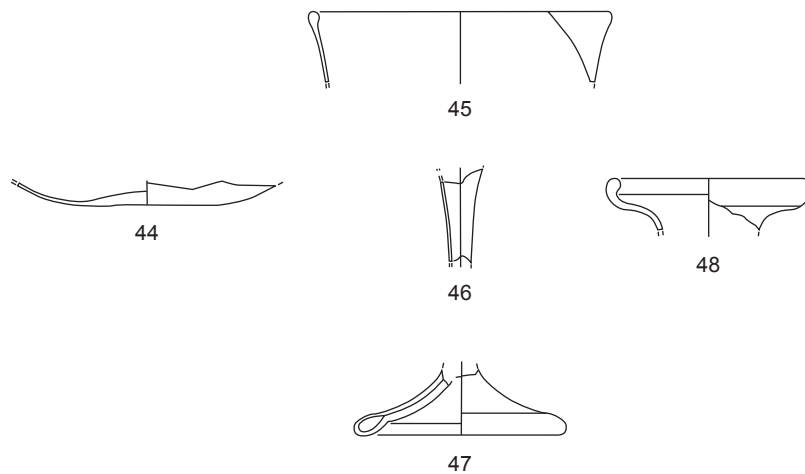

E.234

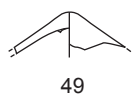

E.252

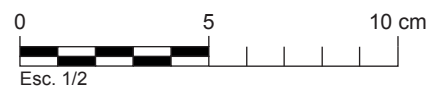
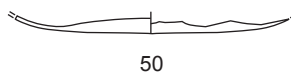

E.3



E.11



E.20



E.37



E.41

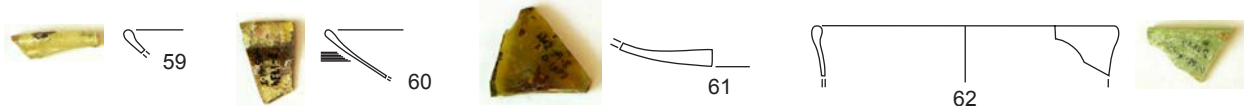

E.76

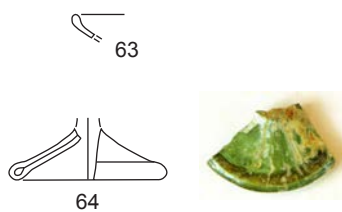

E.85

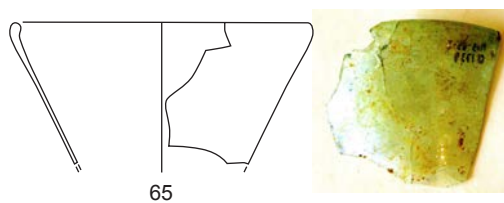

E.119

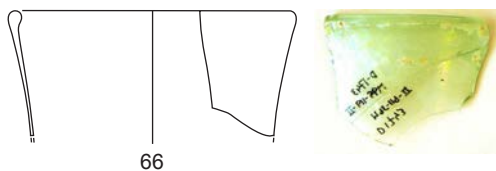

E.132



E.152

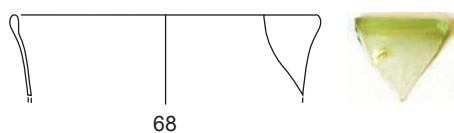

E.160

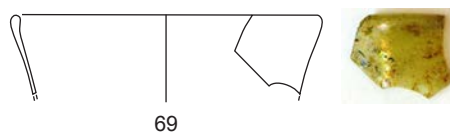

E.160



E.189

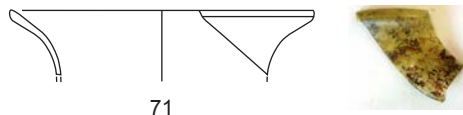

E.208

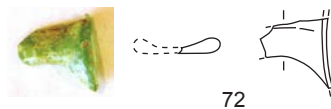

E.221

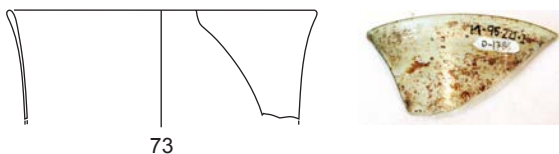

E.232



E.240

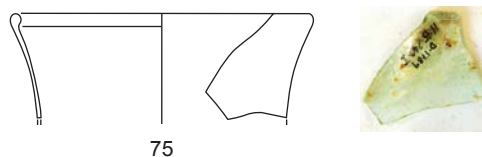

E.248

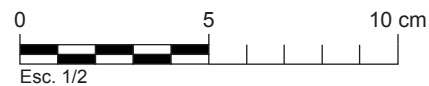
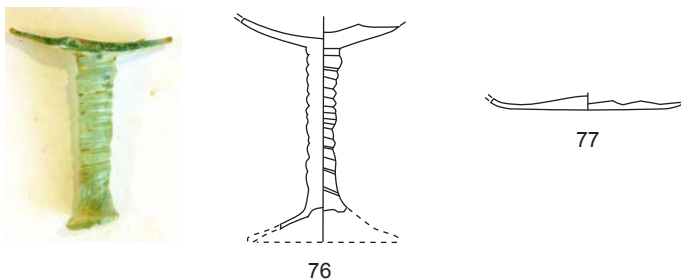



Cova de les Monedes - Fondal de Valldellós (Mediona)

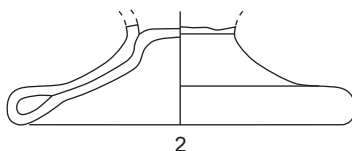

Can Simó (Sant Llorenç d'Hortons)



Fotografia de Jordi Roig Buxó 1994

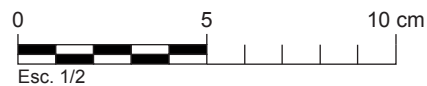
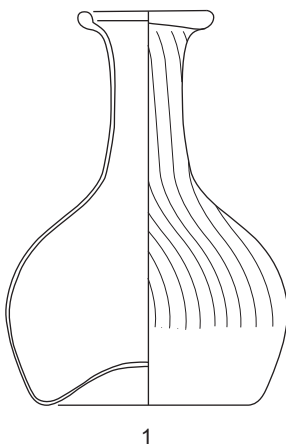

UE.7

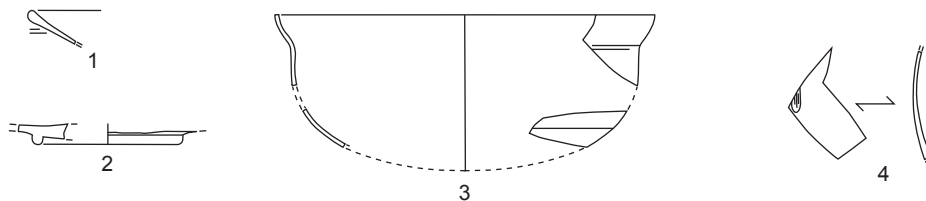

UE.22



UE.23

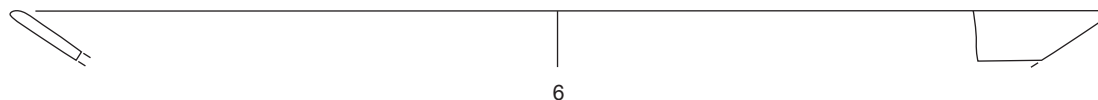

UE.33

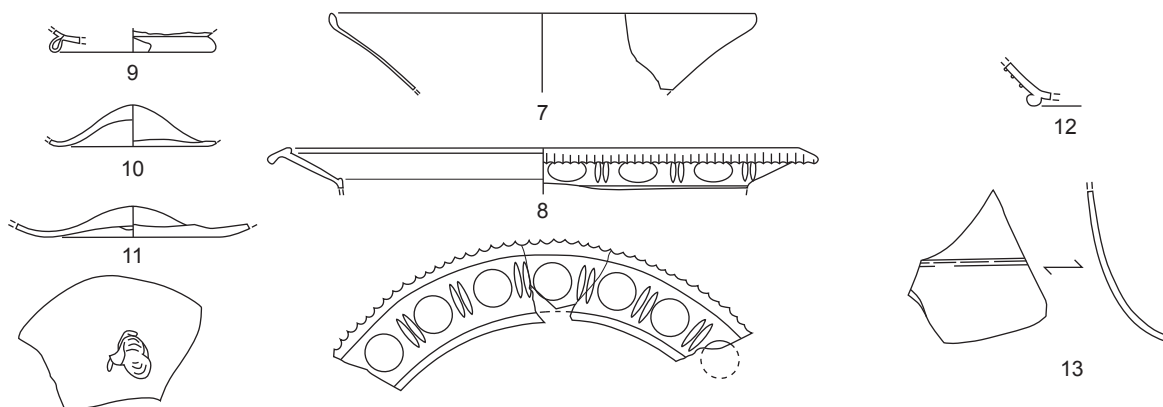

UE.41



UE.52

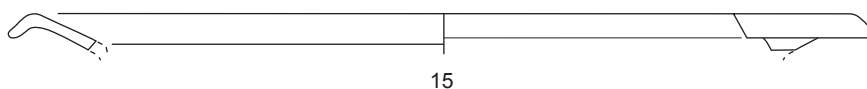

UE.75

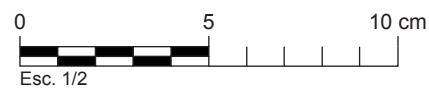
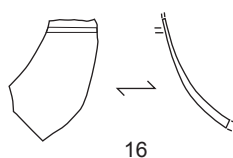

SUPERFICIAL

UE.1001

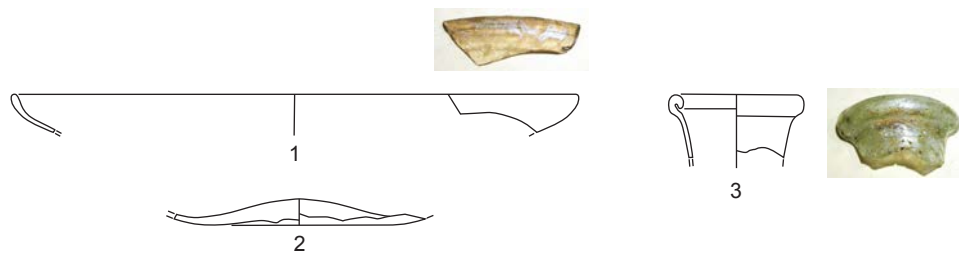

SECTOR 3

UE.1032

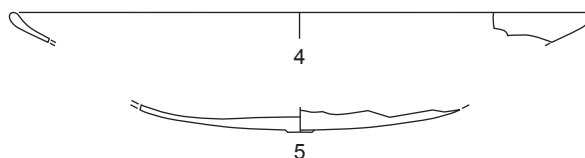

UE.1110



UE.1542

UE.1552

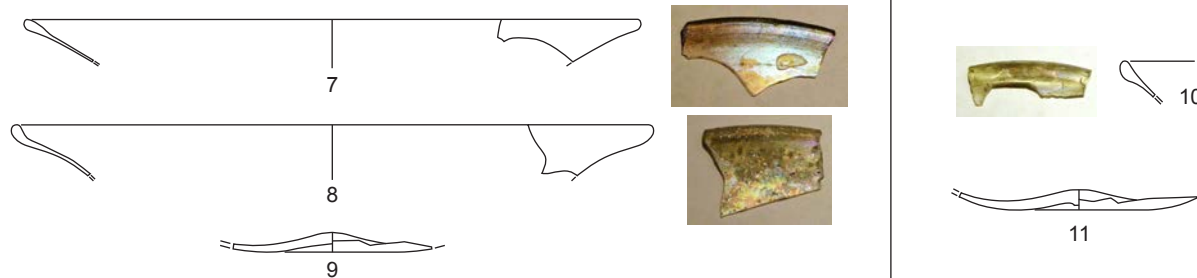

UE.1576

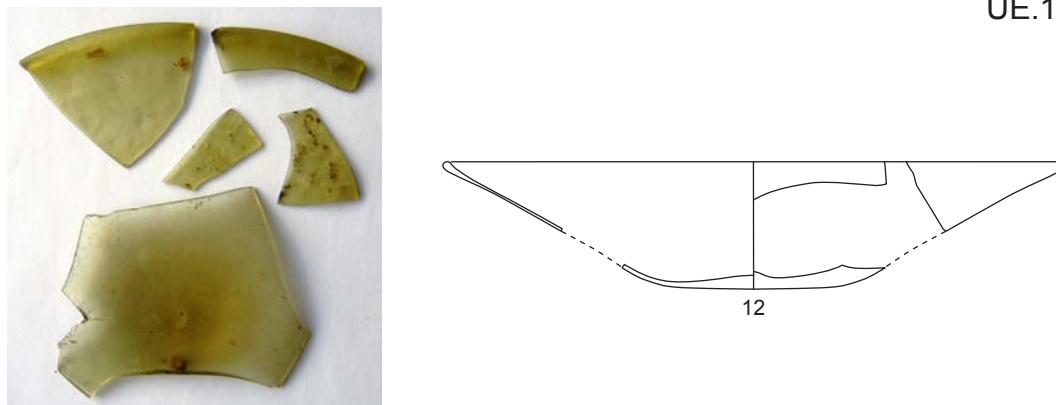

UE.1591

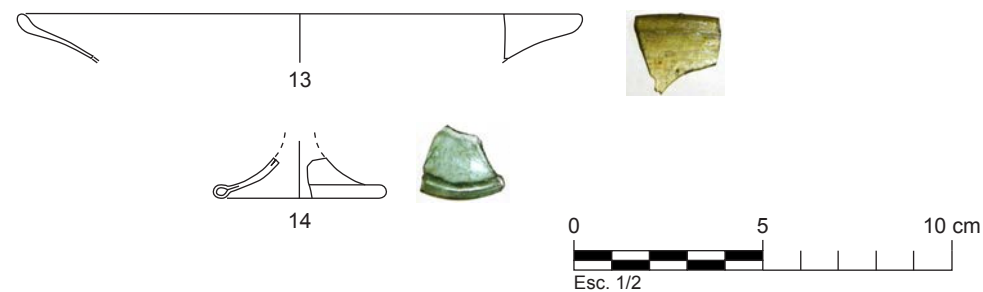

SECTOR 3

UE.1596

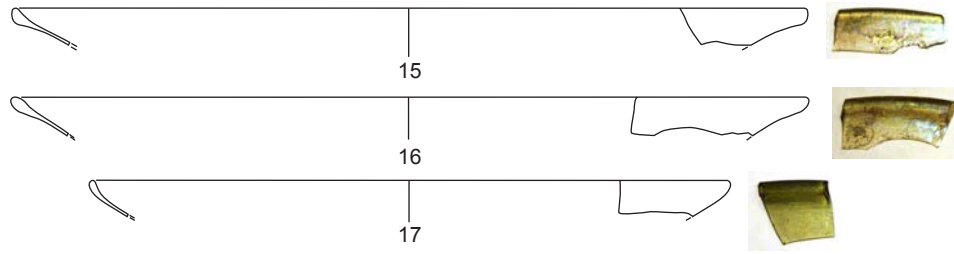

UE.1598

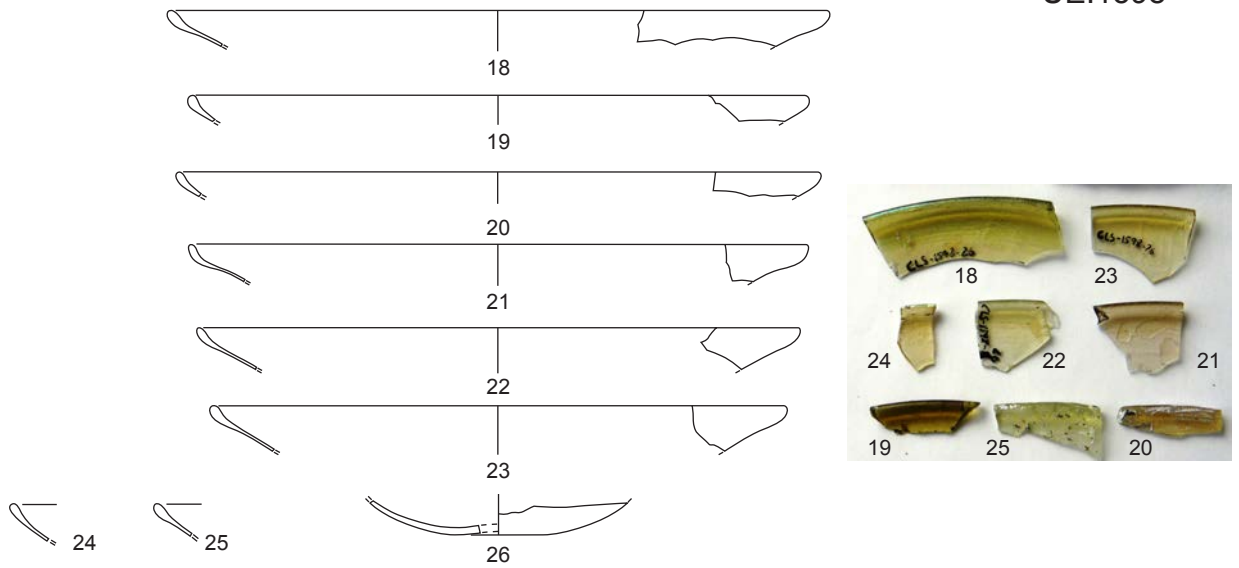

UE.1607

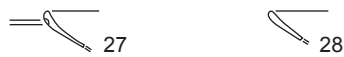

UE.1610

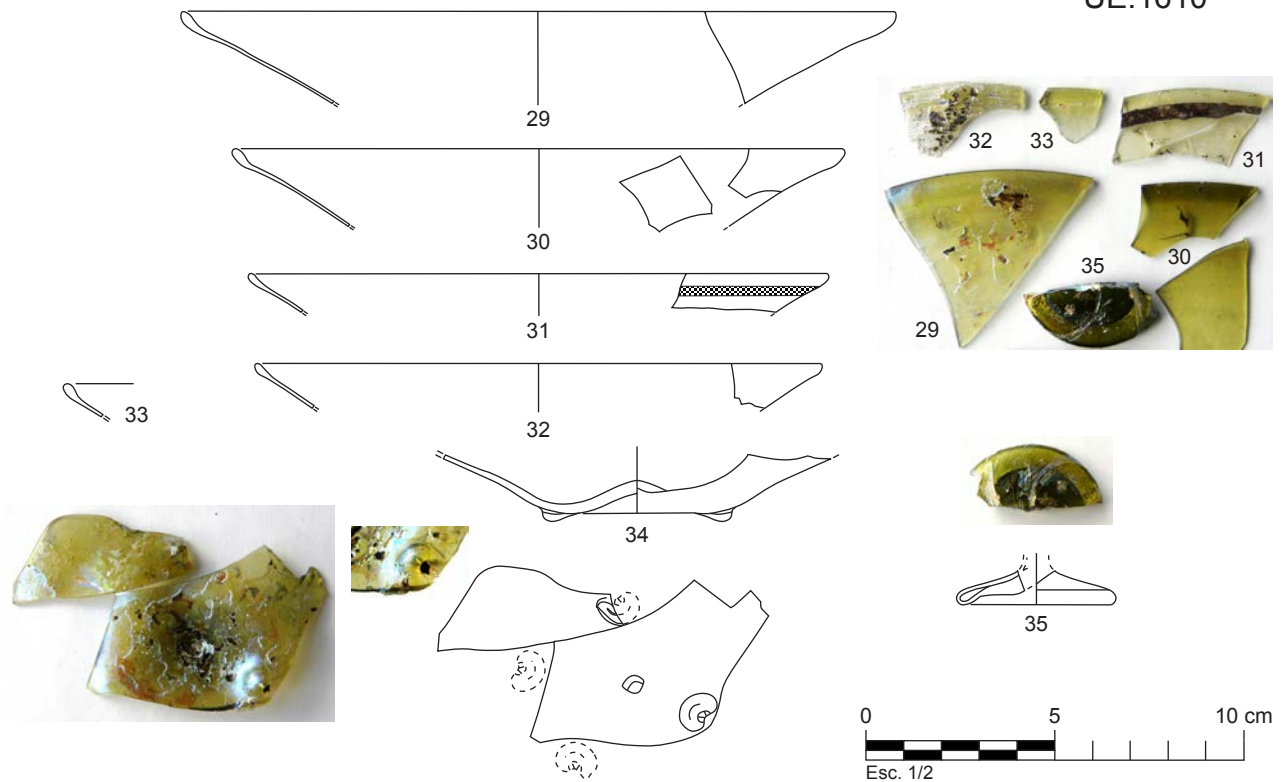

SECTOR 4

UE.1056

SECTOR 5

UE.1491

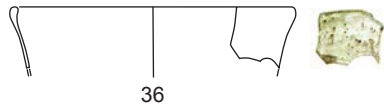

36

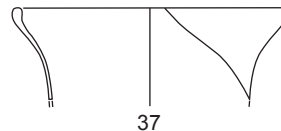

37



SECTOR 8

UE.1257

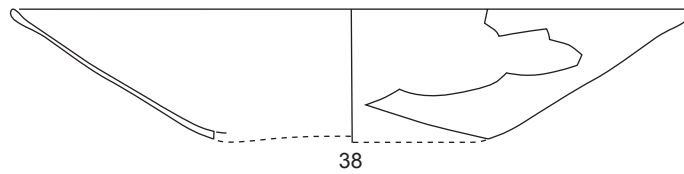

38



41



39



40



UE.1299

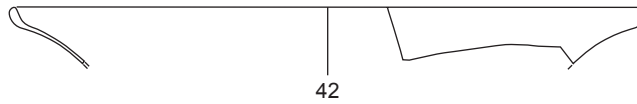

42



43



44

UE.1313

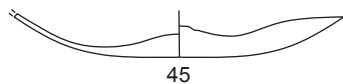

45

UE.1342

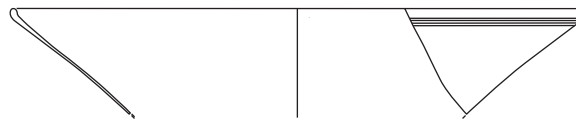

46



UE.1343



47

SECTOR 11

UE.1144

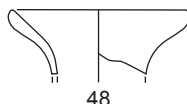

48

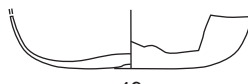

49

UE.1387



50



51

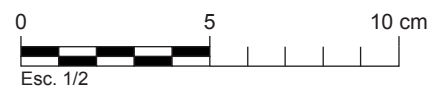

Esc. 1/2

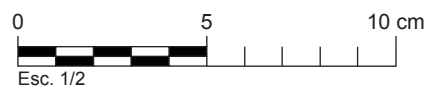
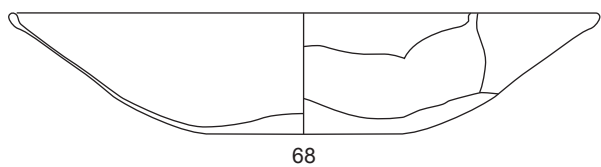
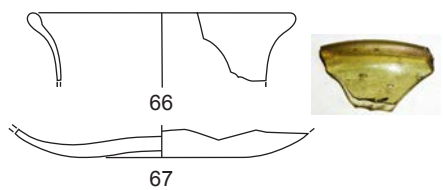
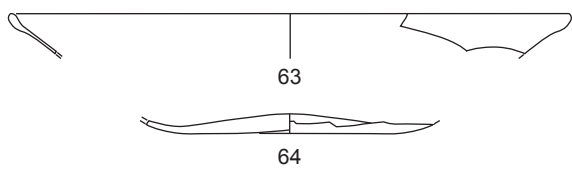
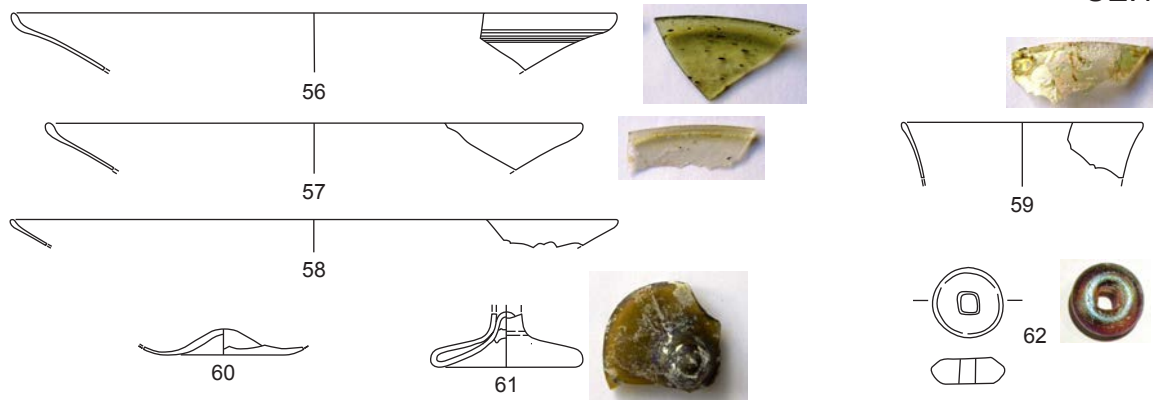
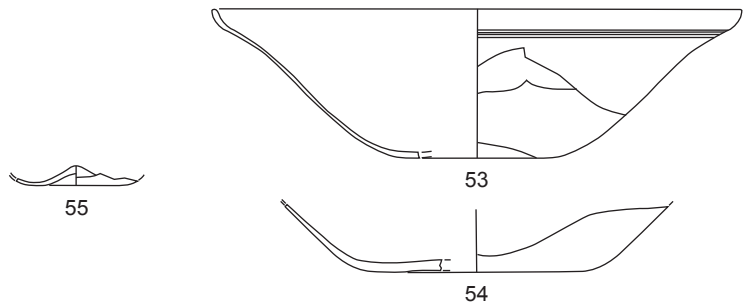

Collet de Clapers

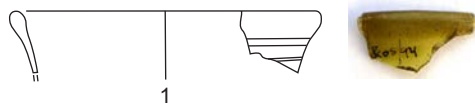

La Païssa

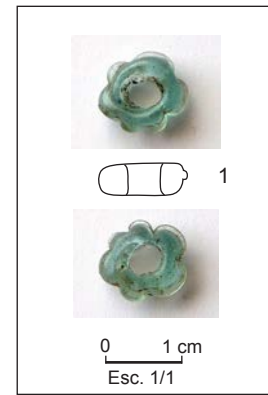

Vinya d'Ogern

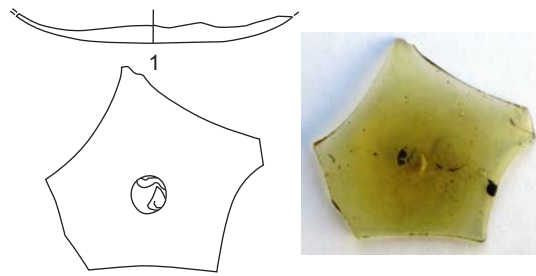

Necròpolis de Can Colomer-Mummany

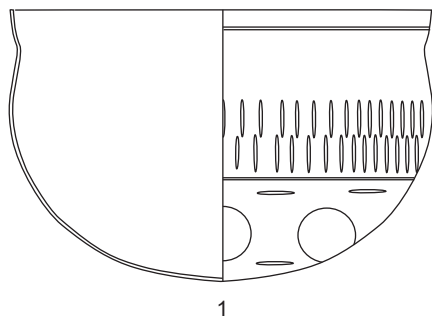

Fotografia Museu Episcopal de Vic  
nº 13240

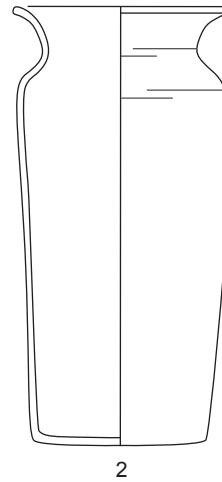

Fotografia Museu Episcopal de Vic  
nº13243

Vil·la Romana de l'Espelt

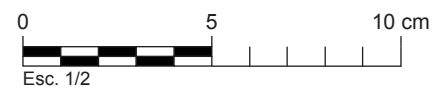
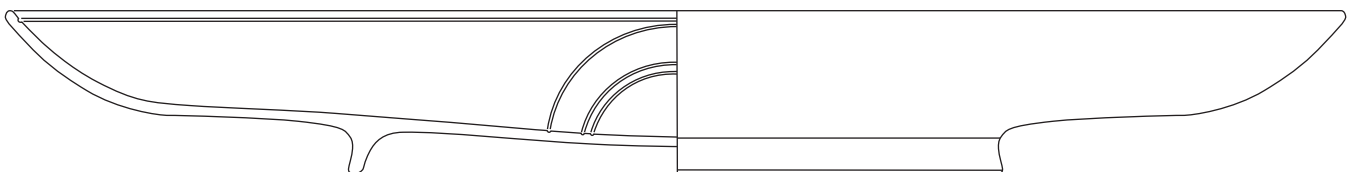

COLLET DELS CLAPERS (Pinós, Solsonès), VINYA D'OGERN (Basella, Alt Urgell), LA PAÏSSA (Monistrol de Calders, Bages), NECRÒPOLIS DE CAN COLOMER (Vic, Osona) i VIL·LA DE L'ESPELT (Odena, Anoia) **LÀMINA 283**

Cronologia: s. III-VII

Quadres C a X

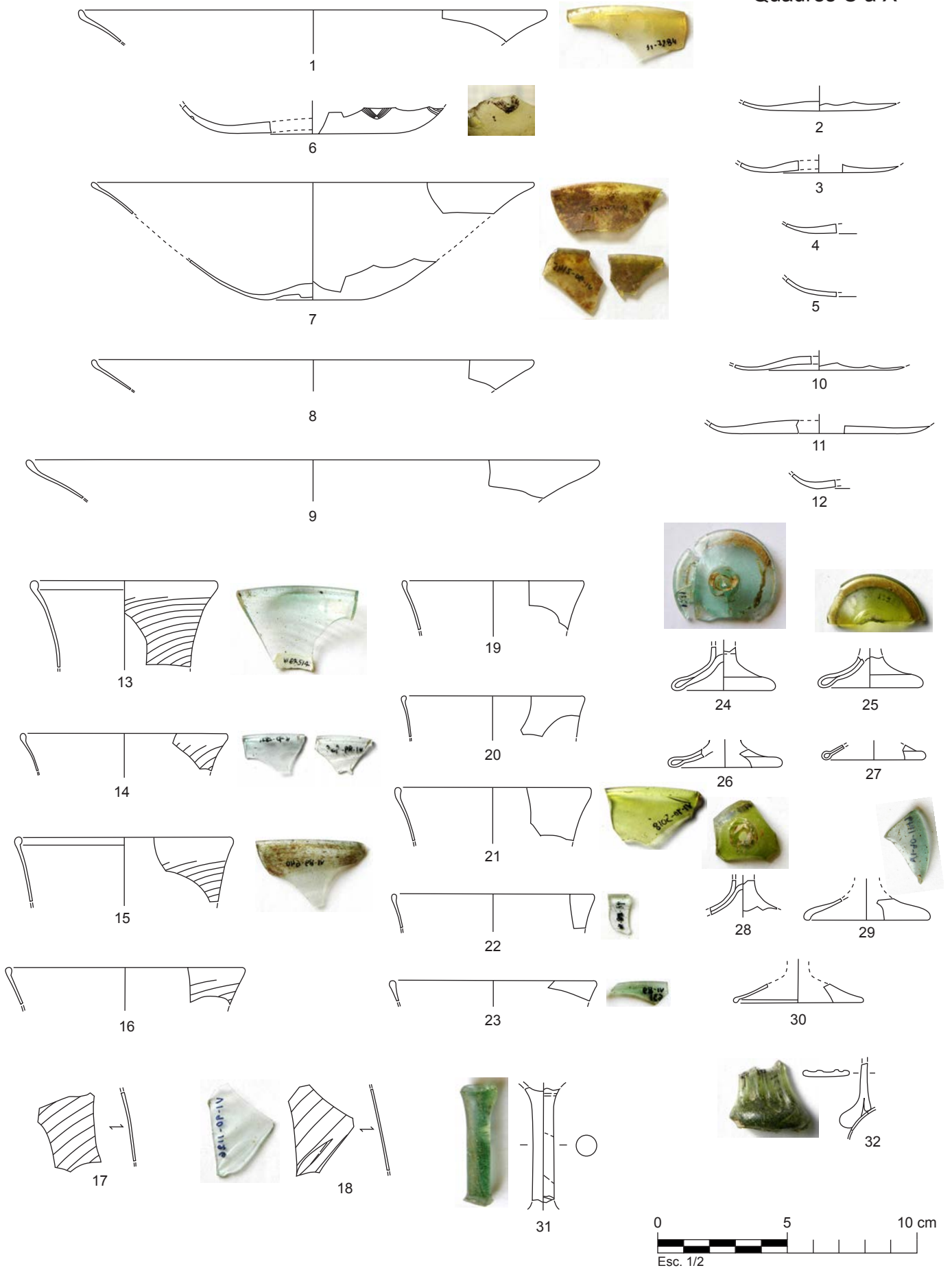



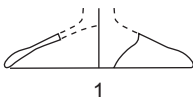

1

UE.376

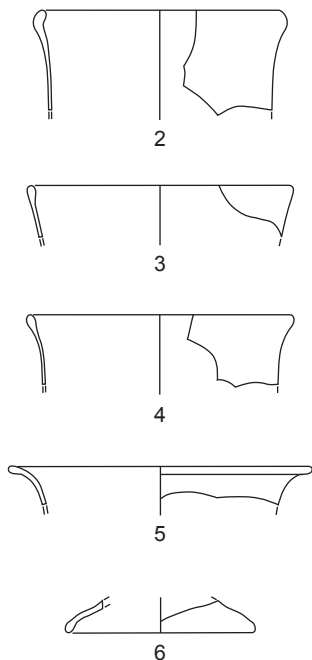

UE.396

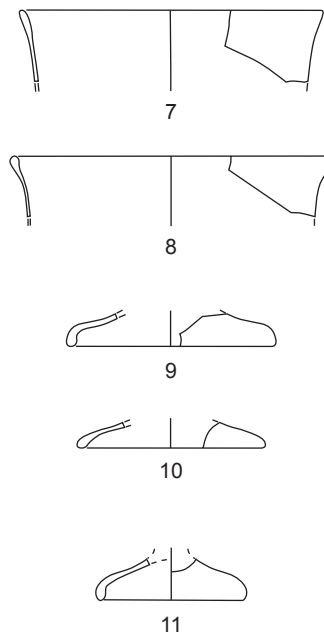

Vores i peus

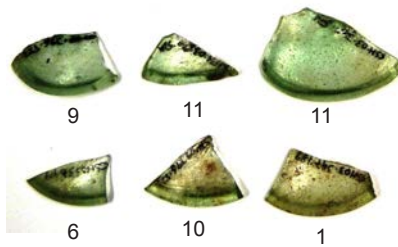

UE.1001



12

UE.1039

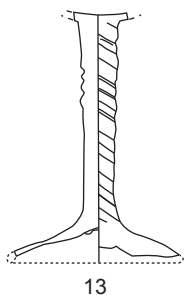

13

UE.2020



14

UE.2021

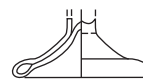

15

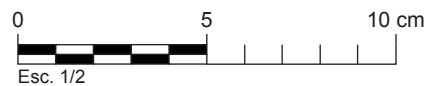

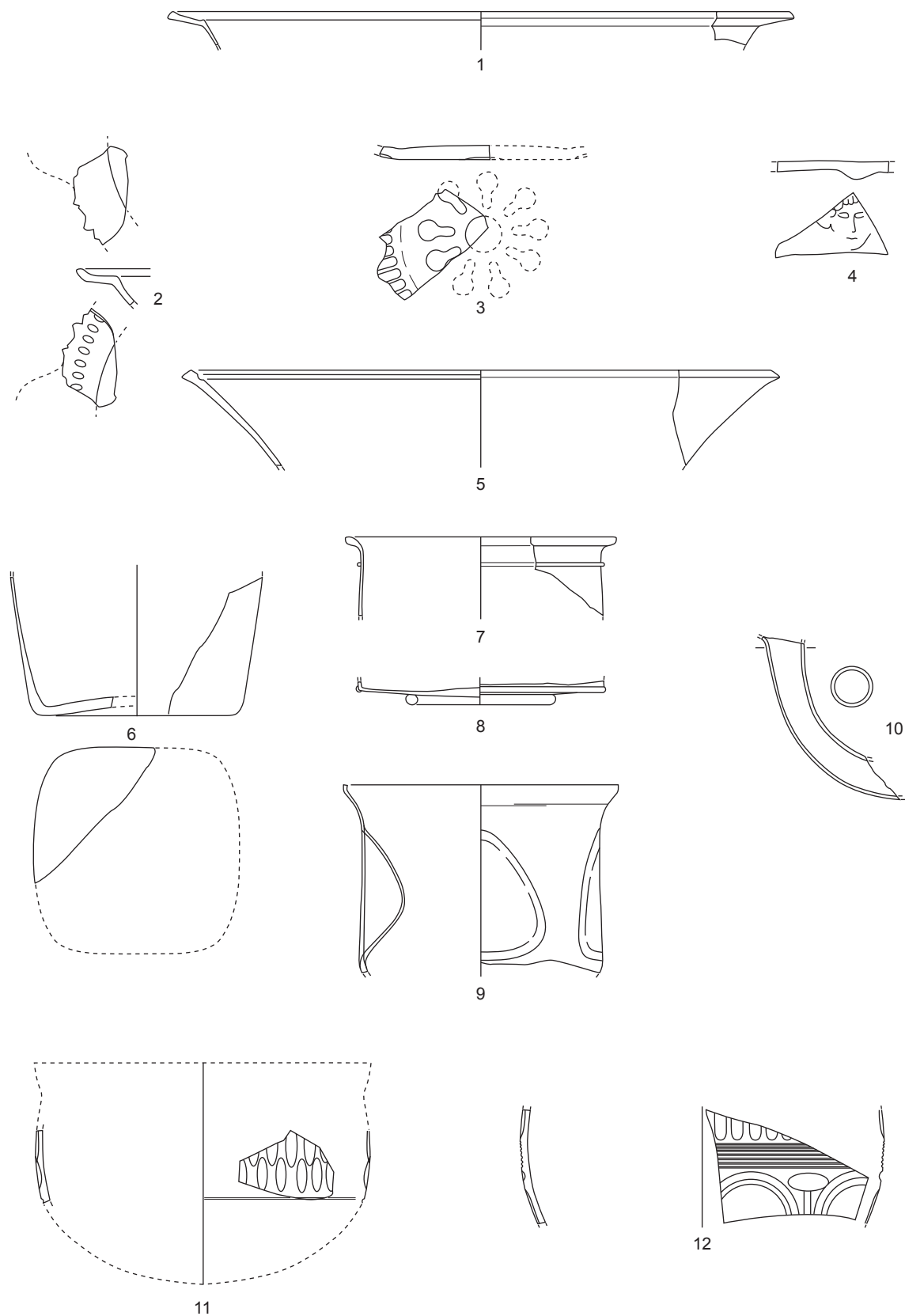

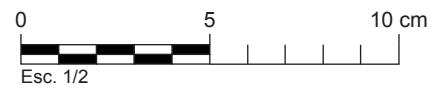
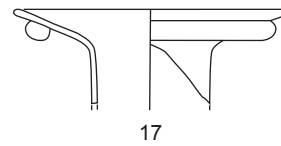
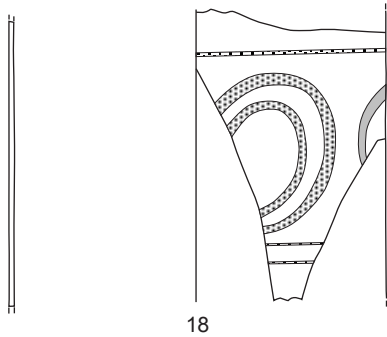
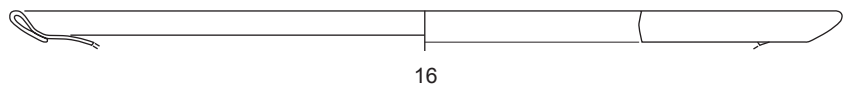
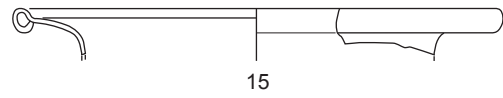
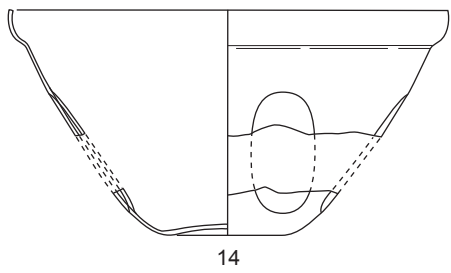
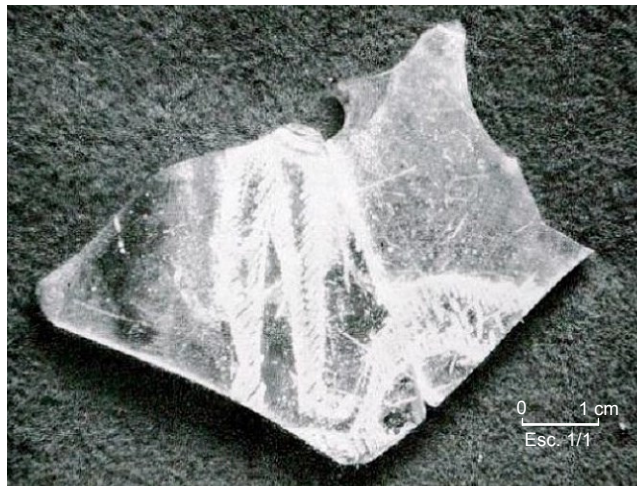
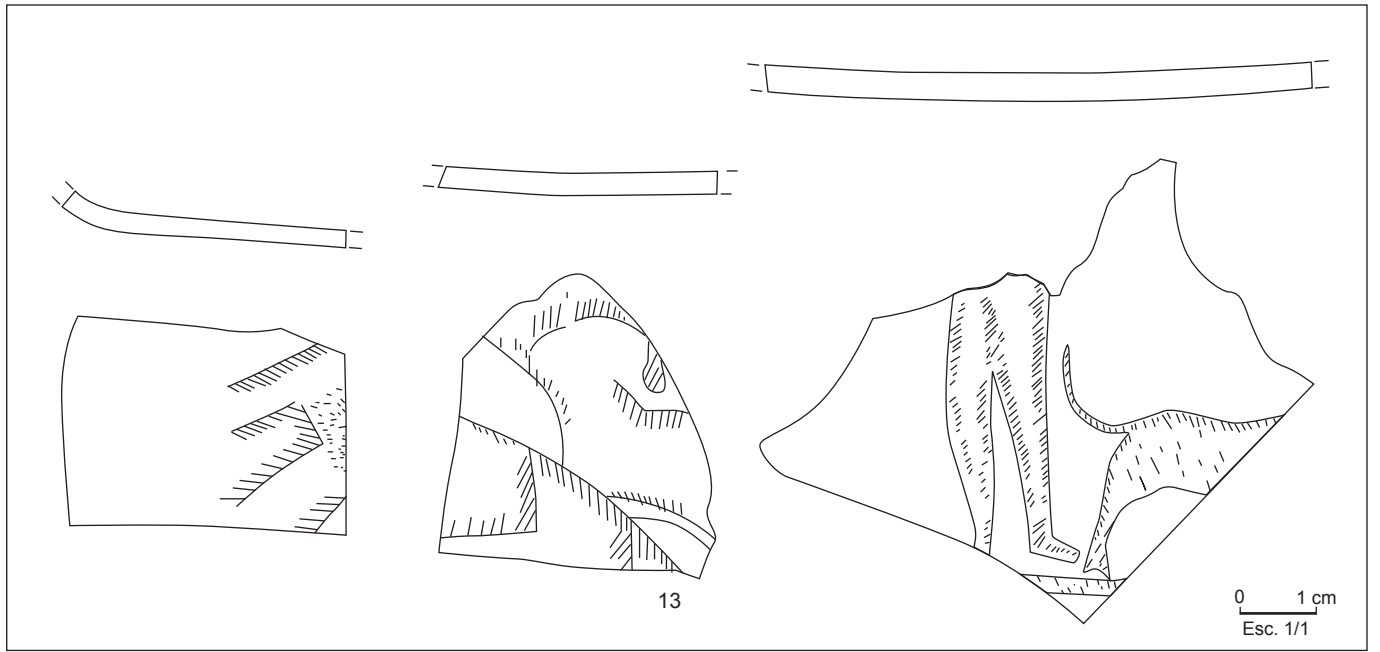

ELS MUNTS (Altafulla, Tarragonès), 1967-71

Sense context, refet a partir dels dibuixos de J.Price (1981). Fotografia de P.M. Berges (1970)

Cronologia: s.IV-V

LÀMINA 287

Caixa 29/39 (Abocador)

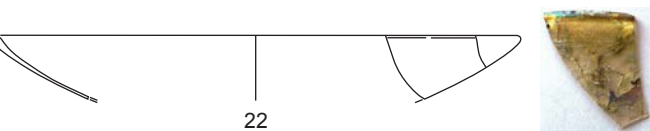
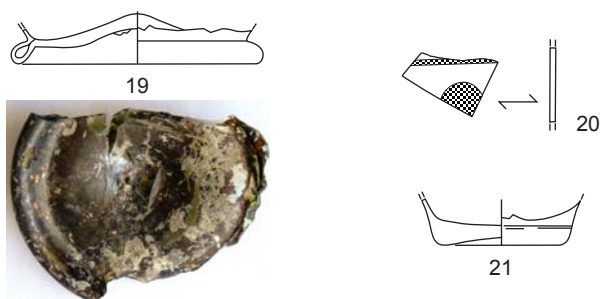
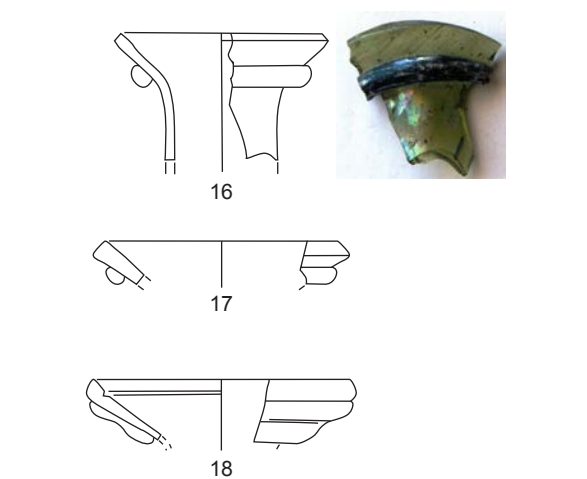
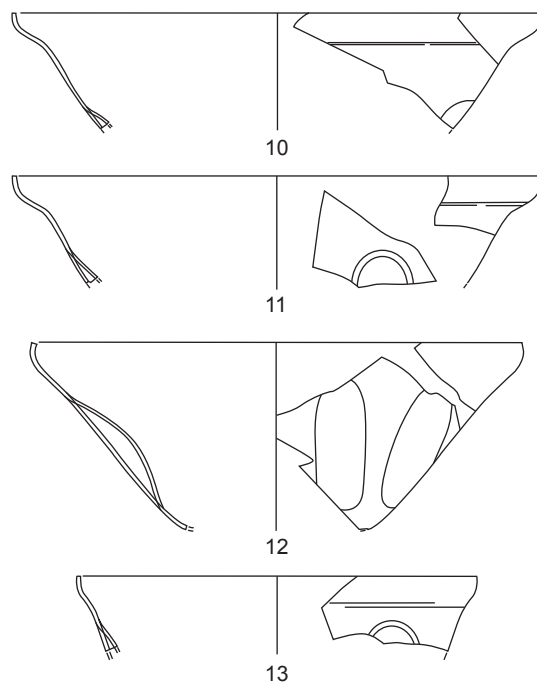
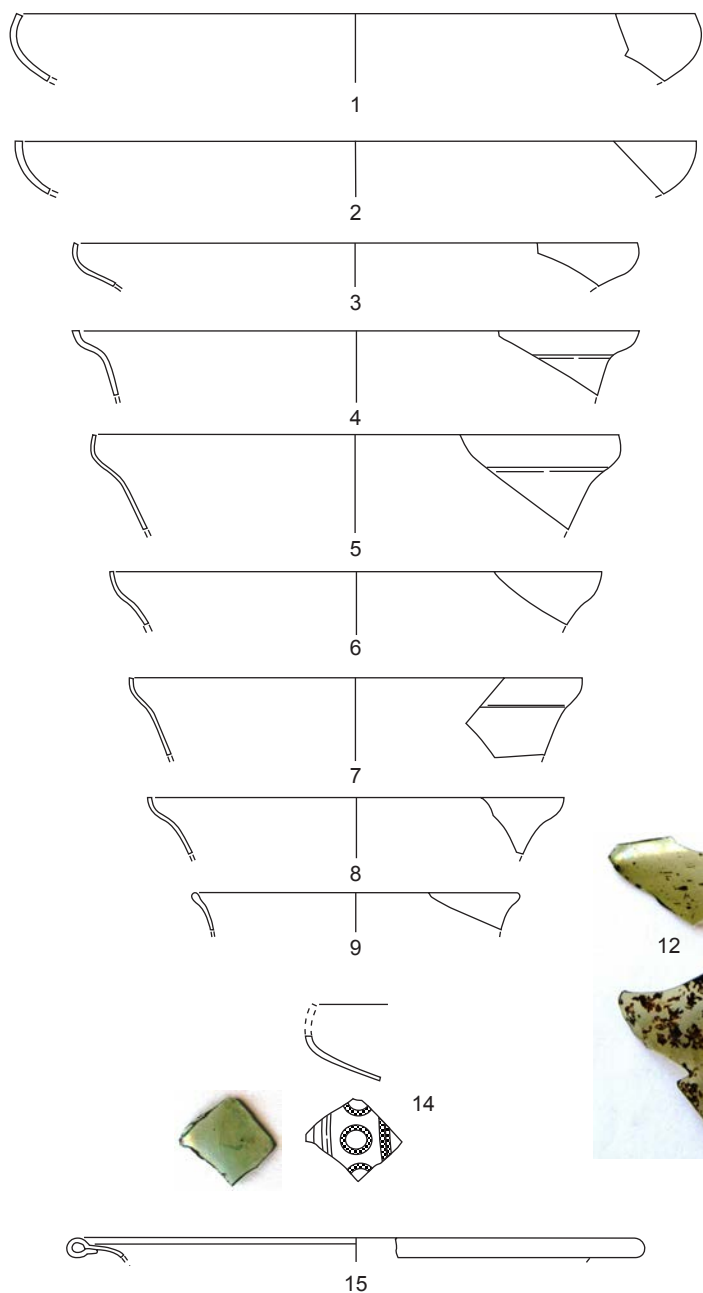

Superfície vinyes (Abocador)

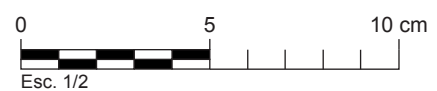
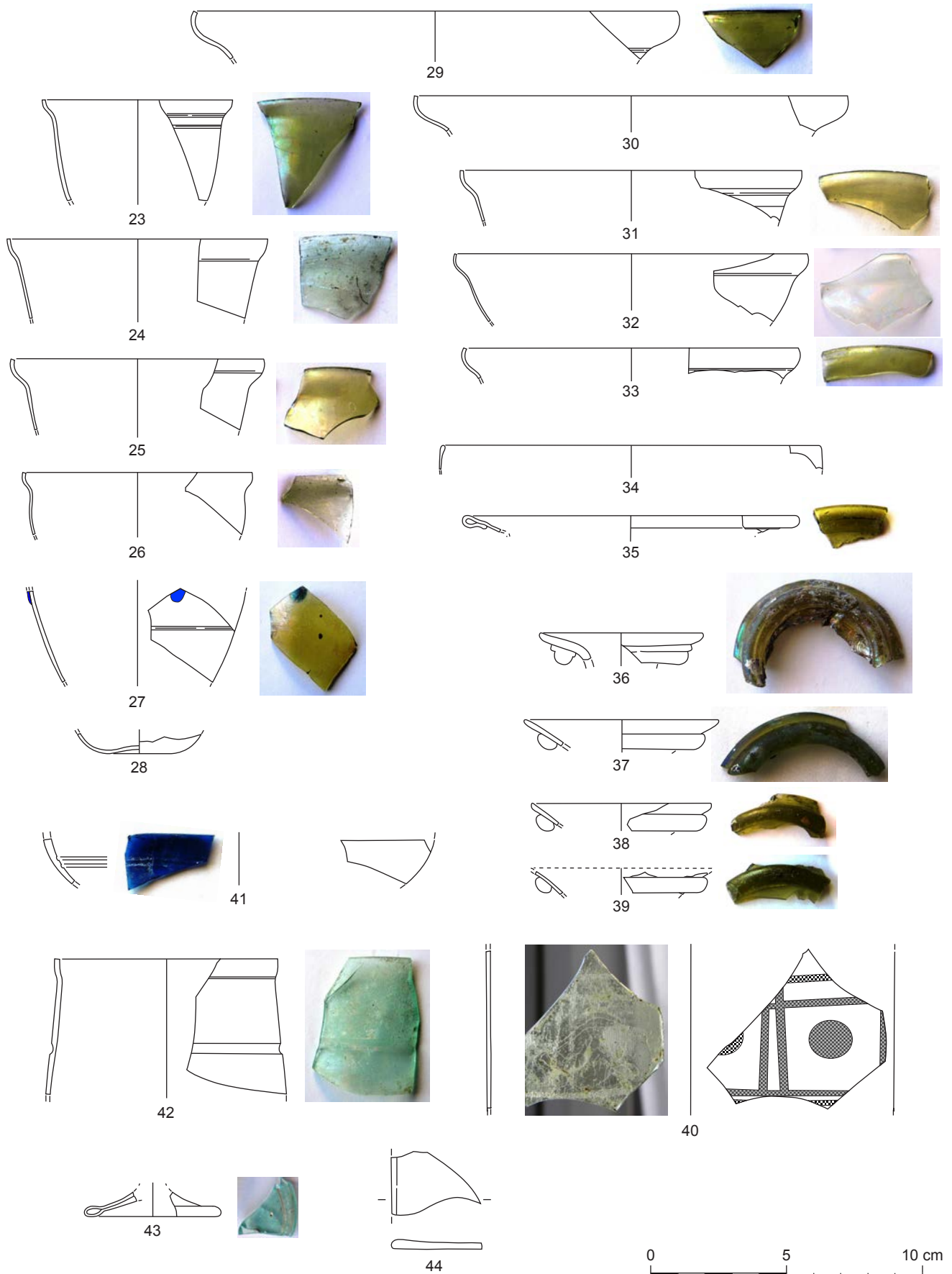

Calicata GRA-Abocador

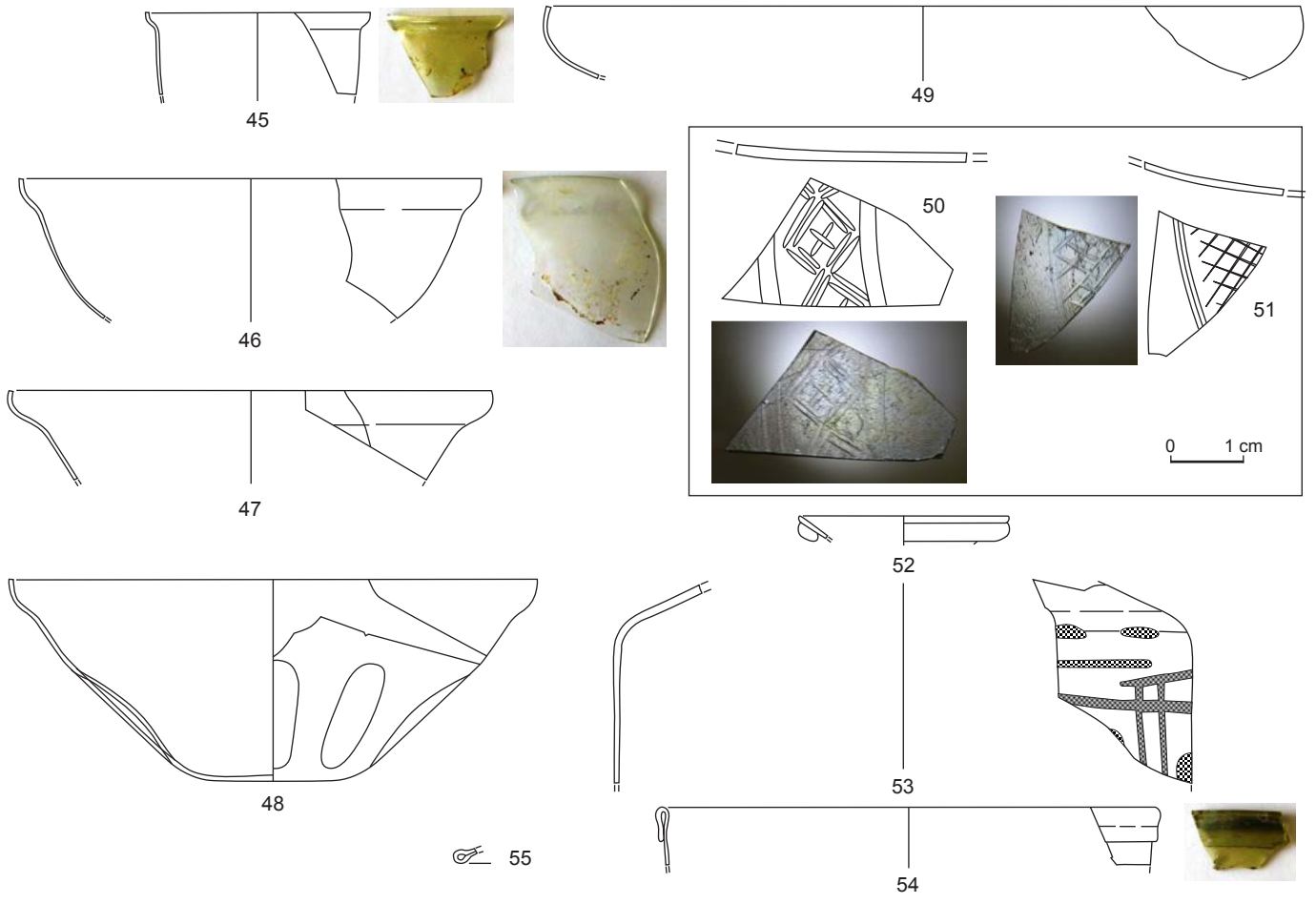

MES-Abocador

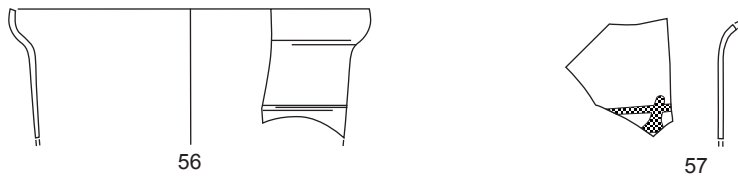

MJM-Abocador

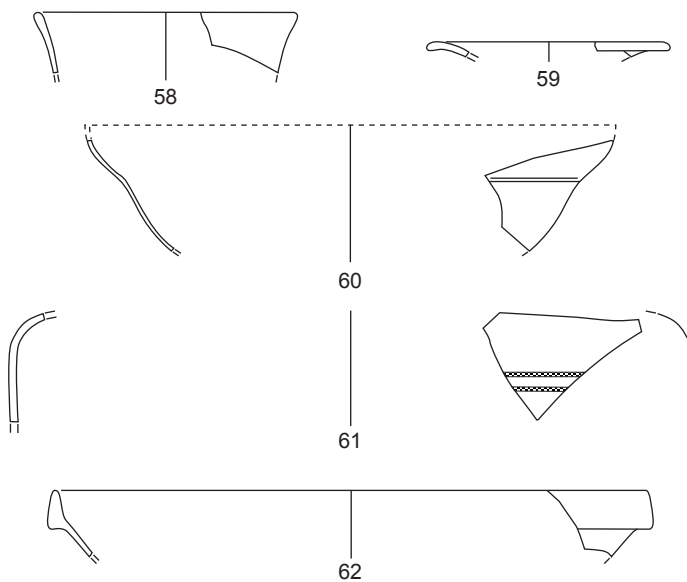

GRAMM-Abocador

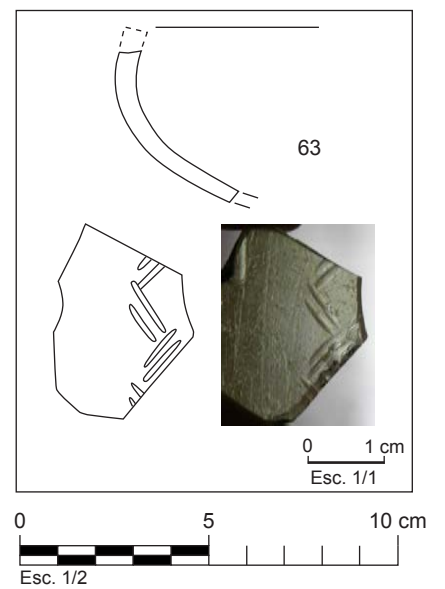

Nymphaeum. A-2

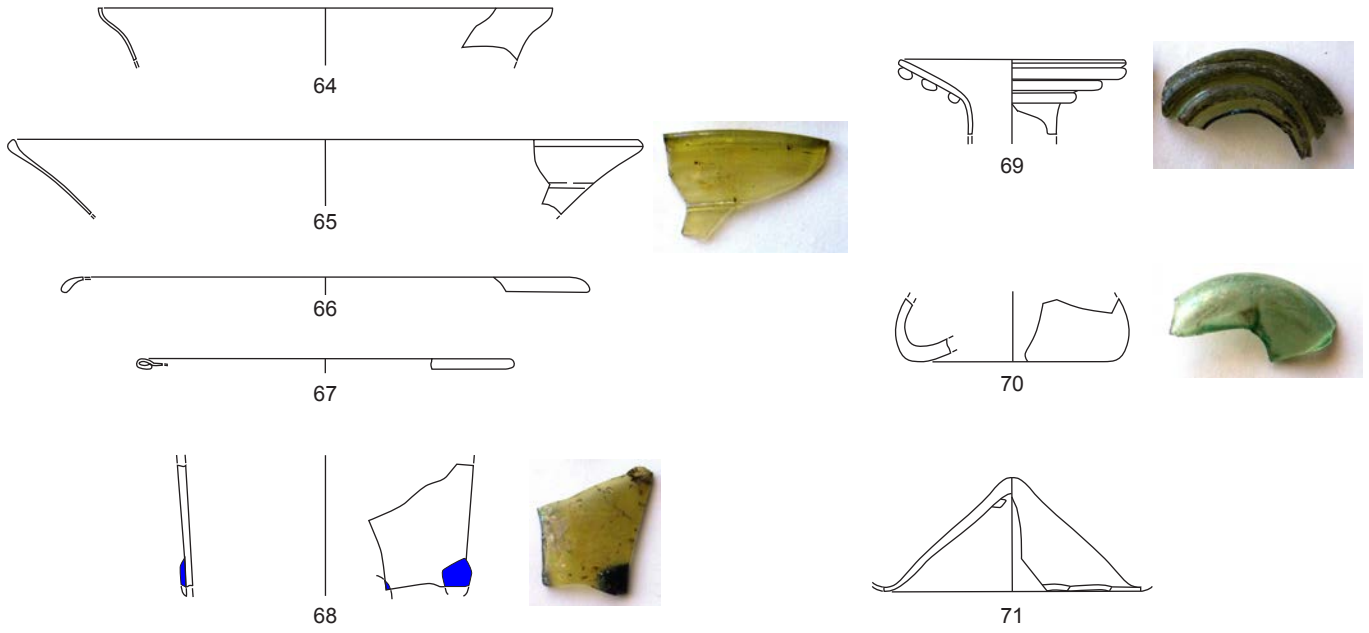

Nymphaeum. 8-A

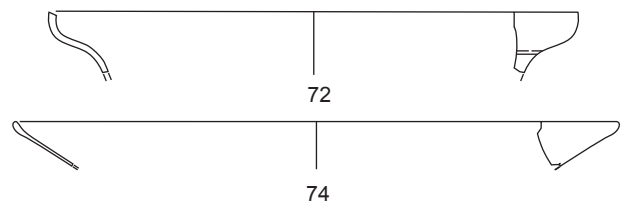
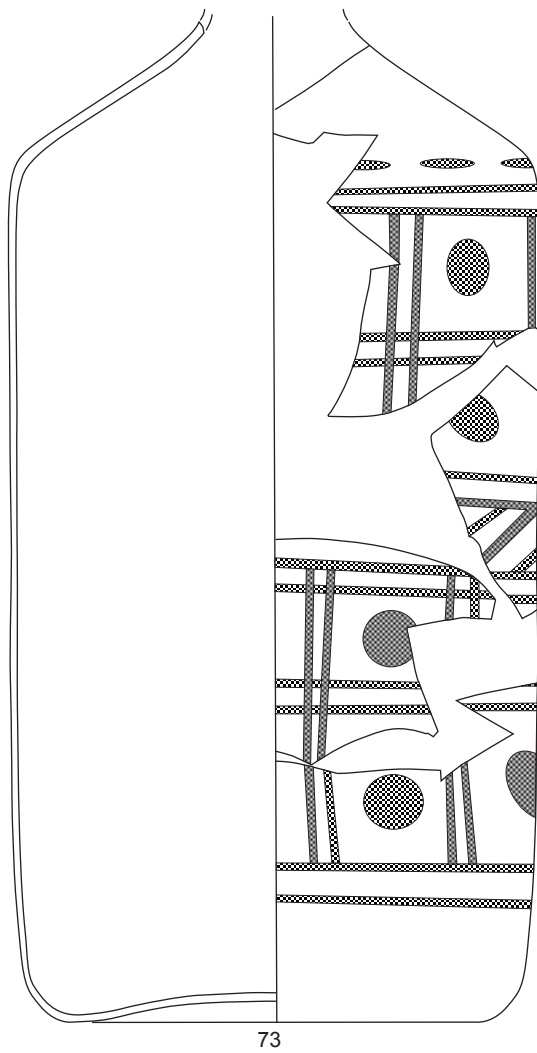

Desaigua Caldarium (Nymphaeum)

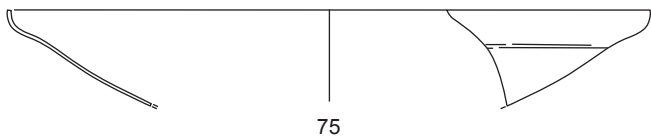

75

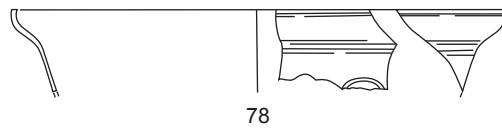

78

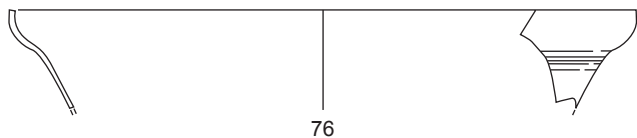

76

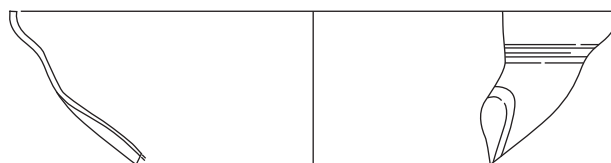

79

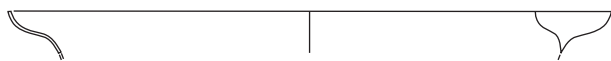

77

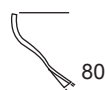

80



81



82



83

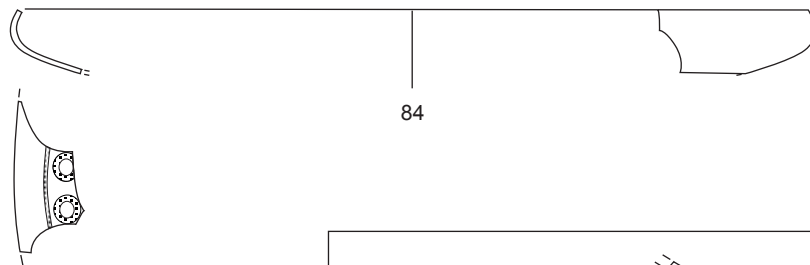

84

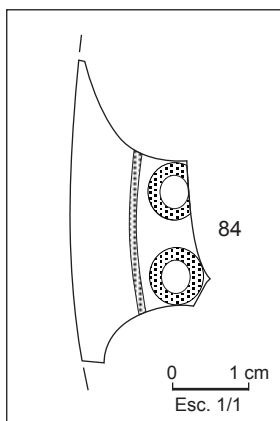

84

0 1 cm  
Esc. 1/1

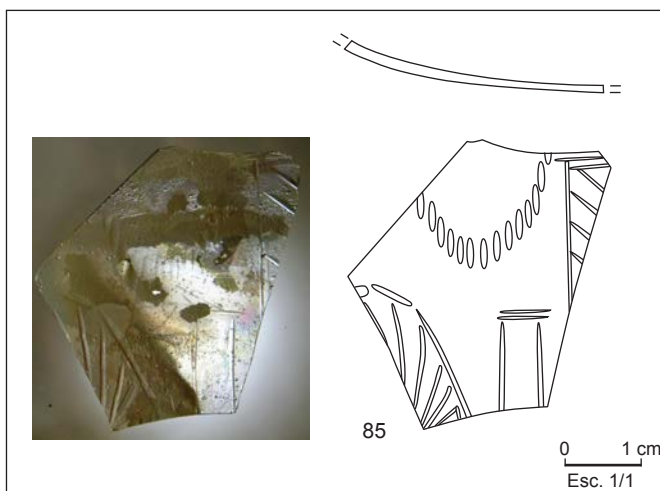

85

0 1 cm  
Esc. 1/1

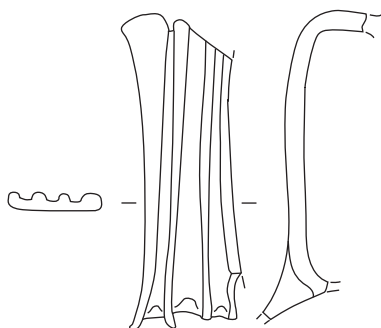

86



87

0 5 10 cm  
Esc. 1/2



GRAMM i Desaigua Caldarium (Nymphaeum)

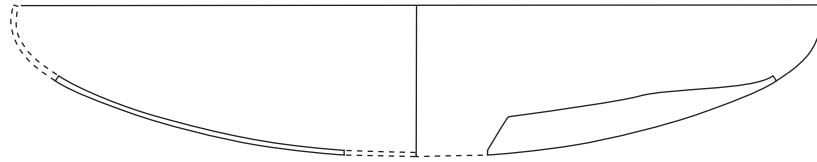

88

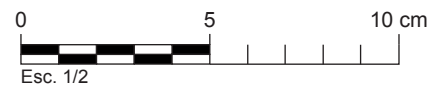
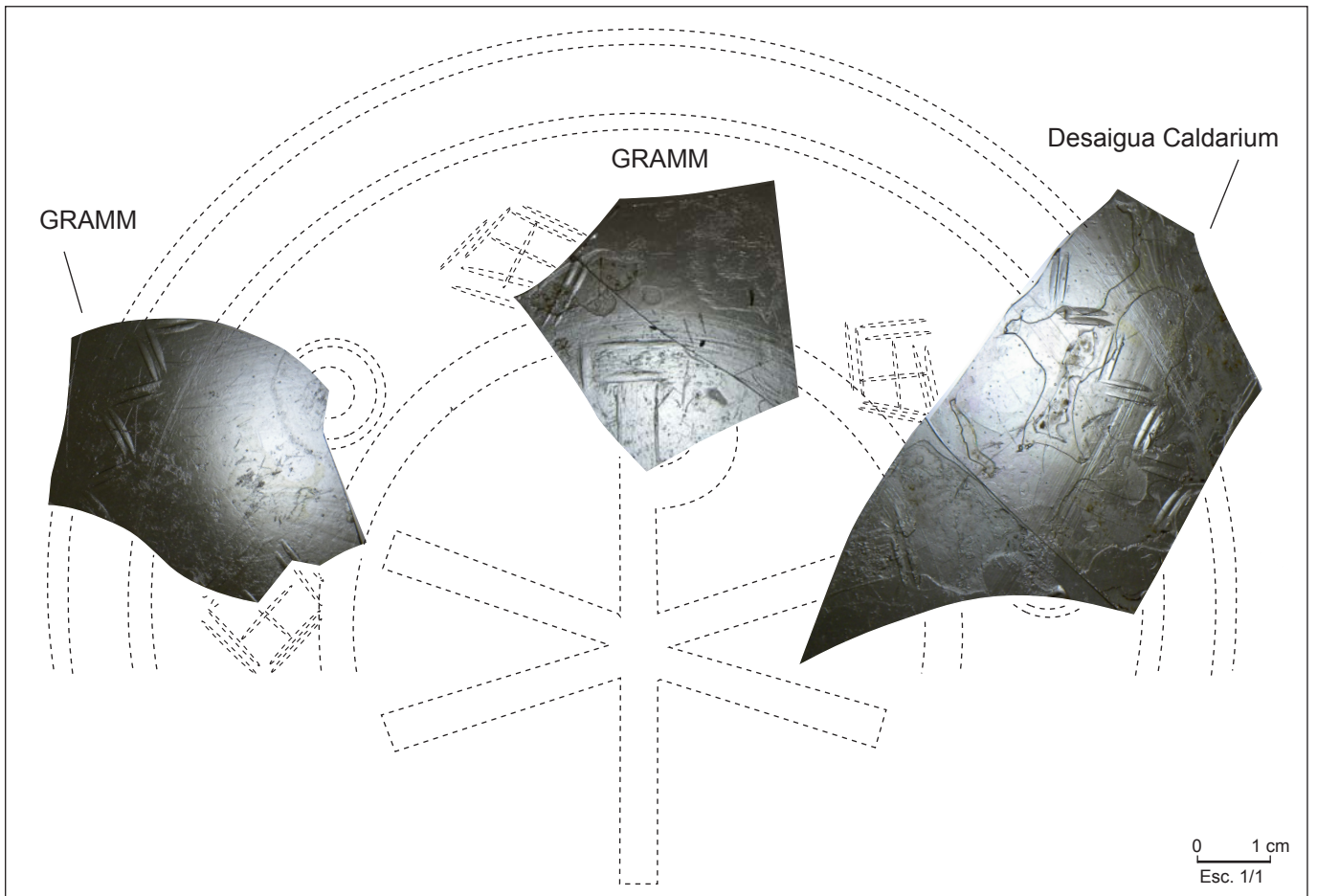
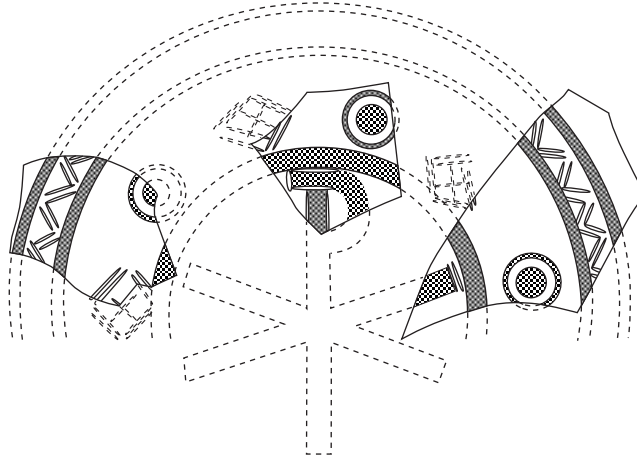

FV2-Voltes

Estàtua

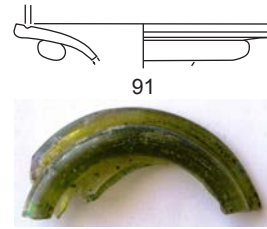
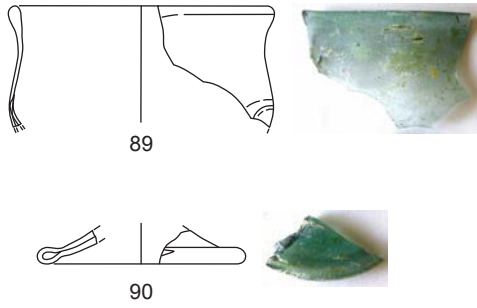

Vitrina Museu

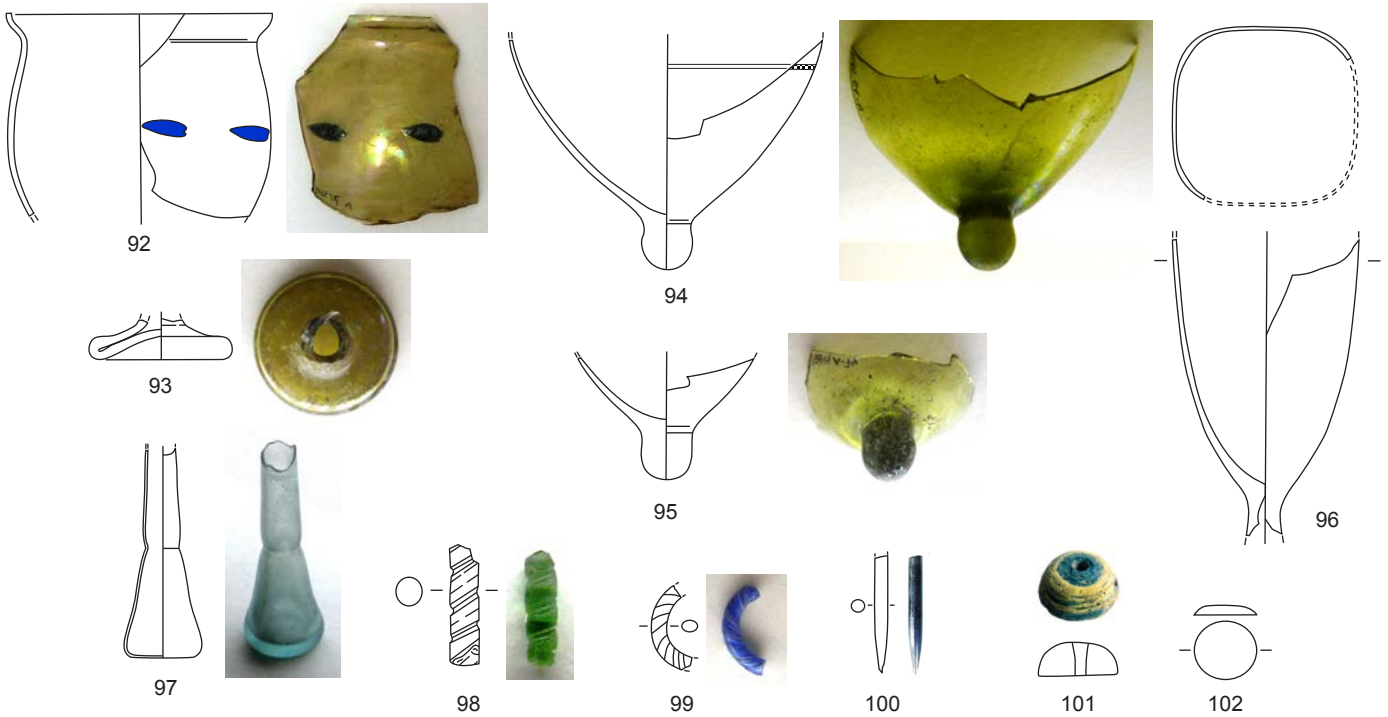

Sense referència

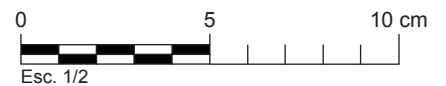
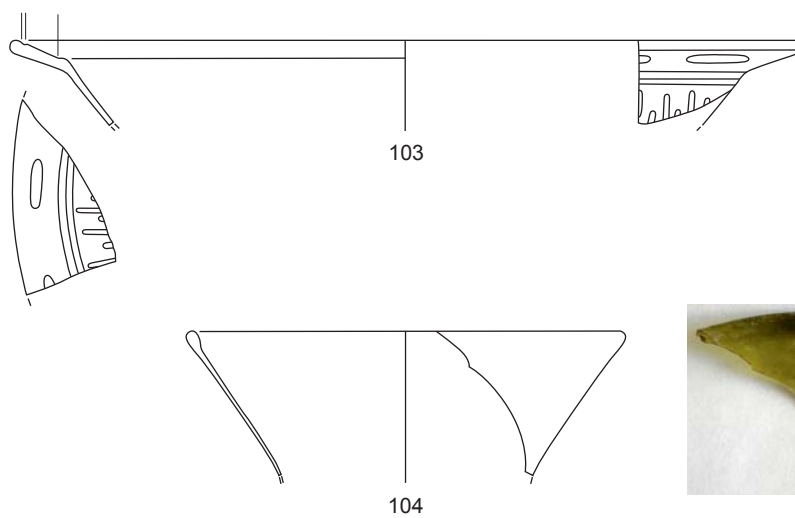

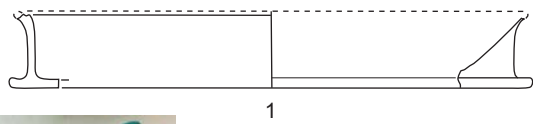

1

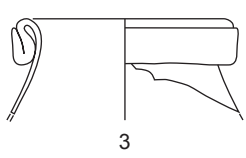

3

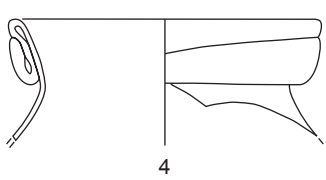

4

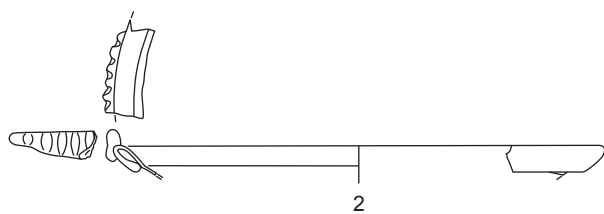

2

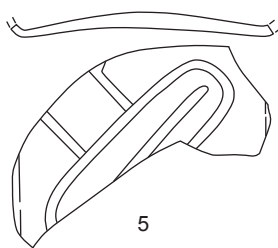

5

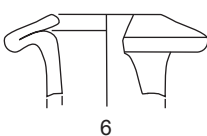

6



7

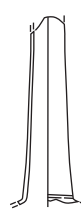

8



11

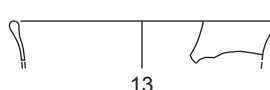

13

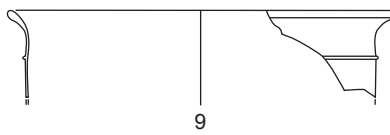

9

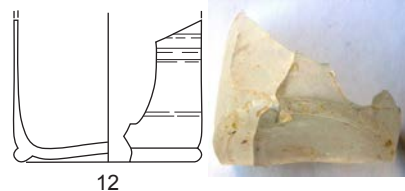

12

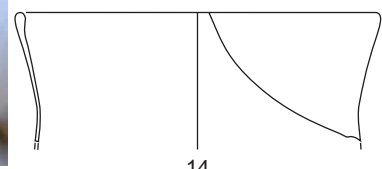

14

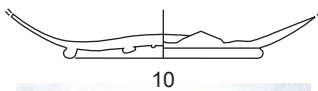

10



16

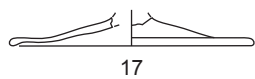

17

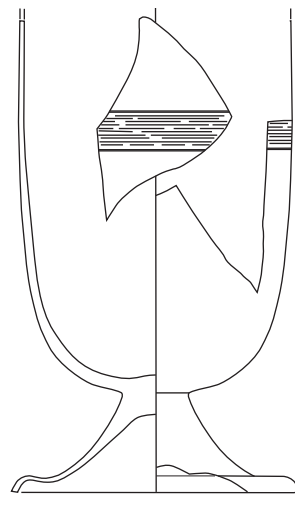

15



18

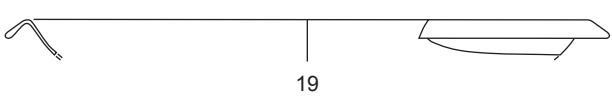

19

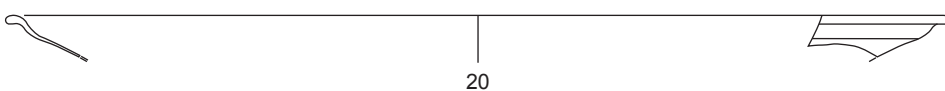

20



21

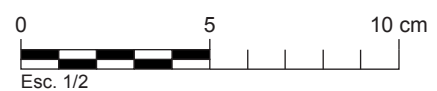

Esc. 1/2

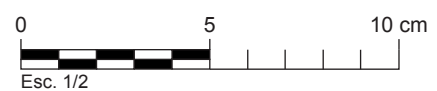
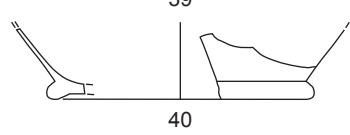
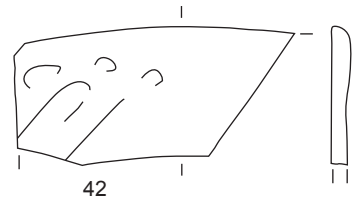
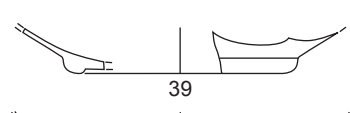
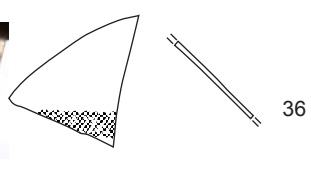
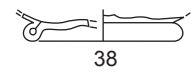
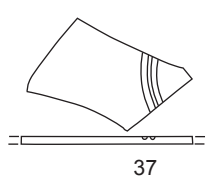
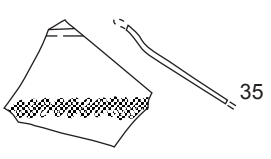
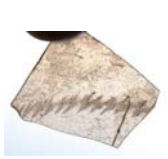
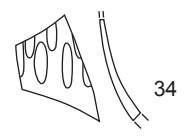
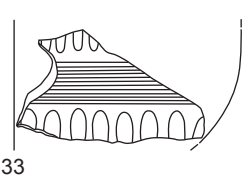
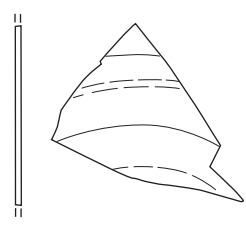
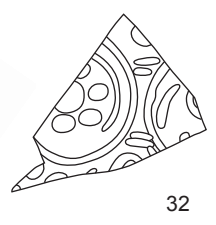
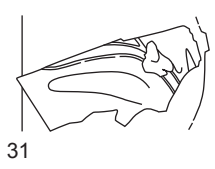
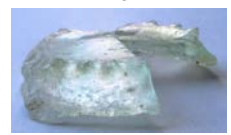
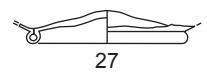
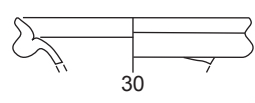
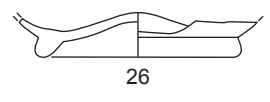
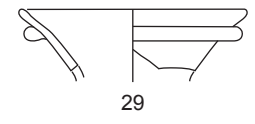
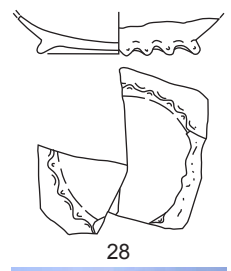
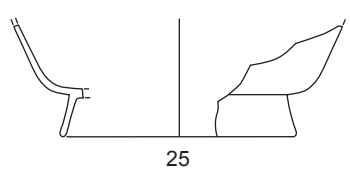
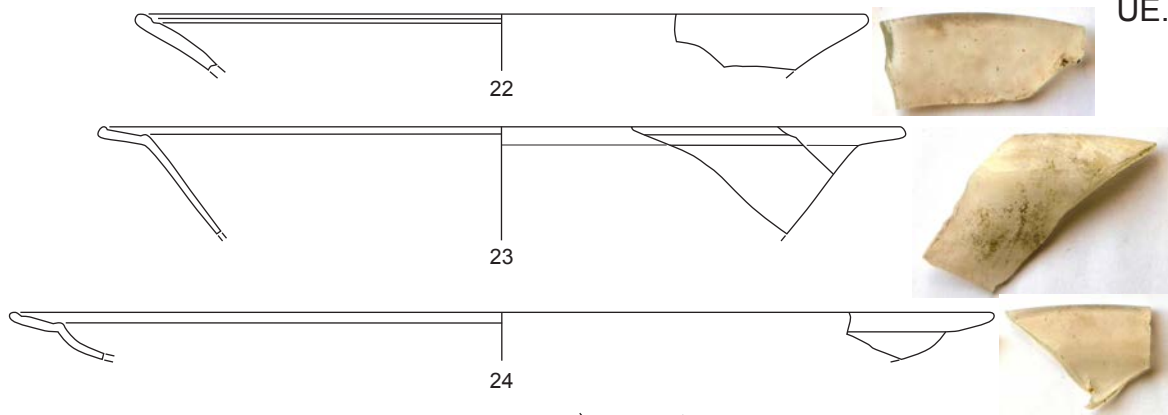

UE.40

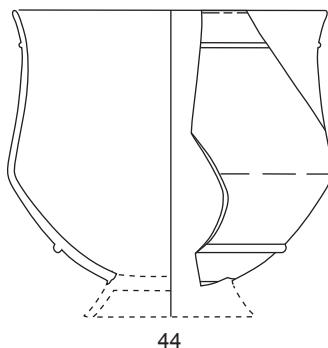
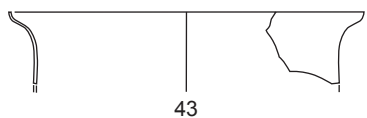

UE.65

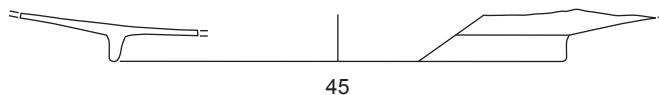

UE.67

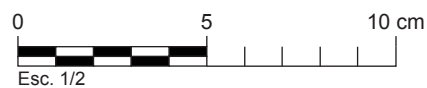
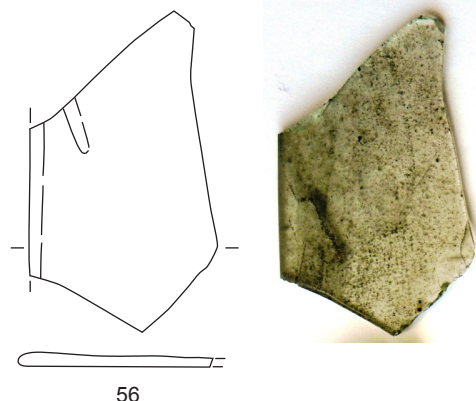
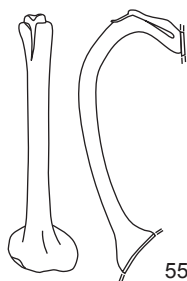
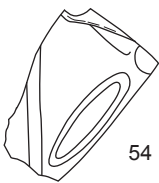
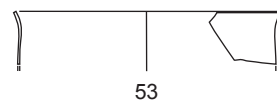
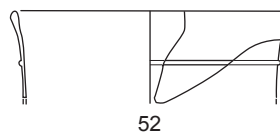
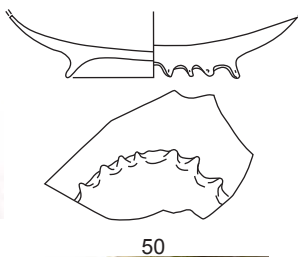
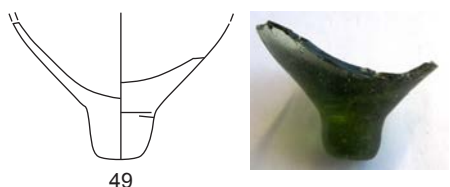
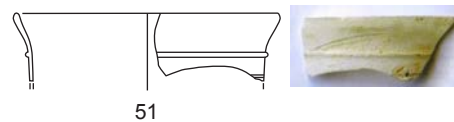
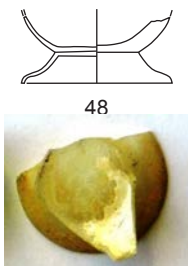
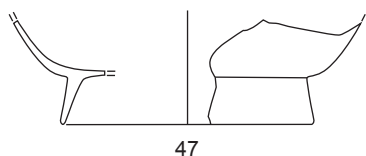
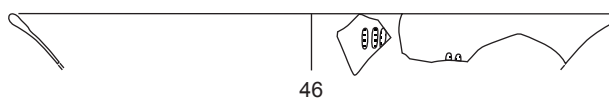

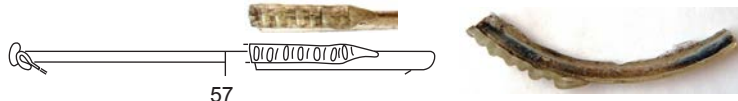

57

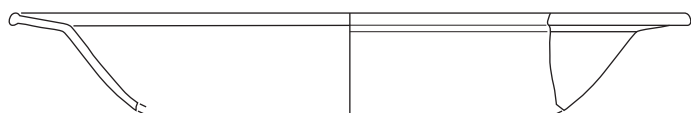

58

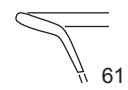

61

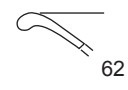

62

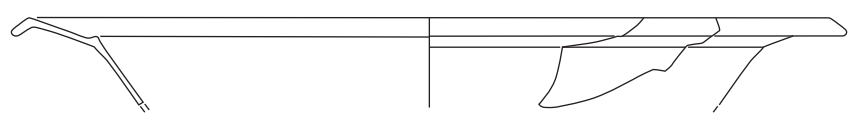

59

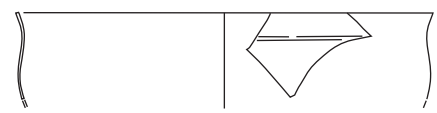

63



60

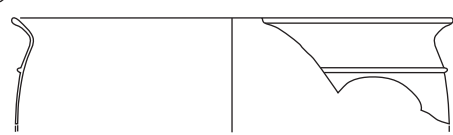

64

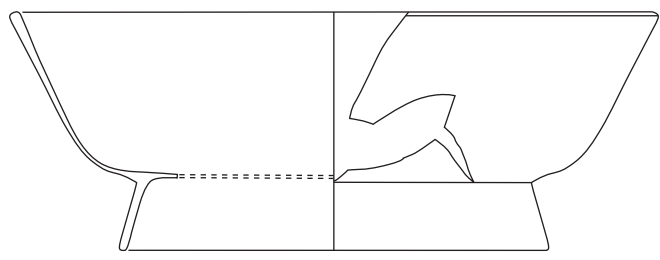

67



65

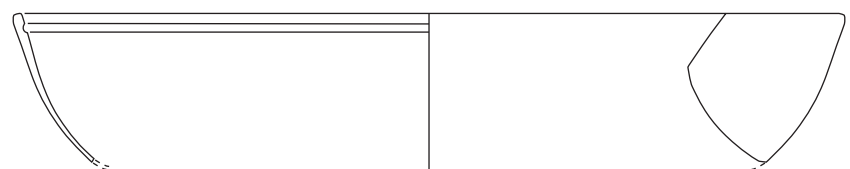

68

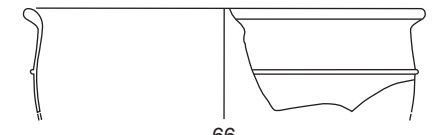

66

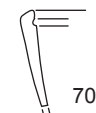

70

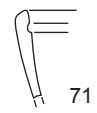

71

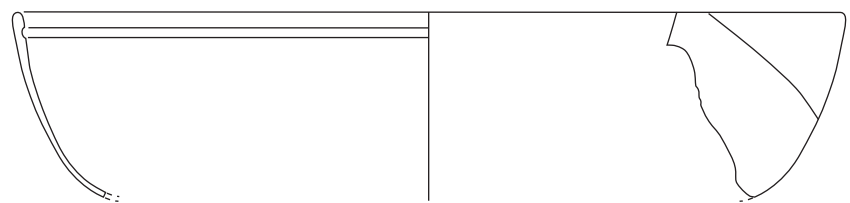

69

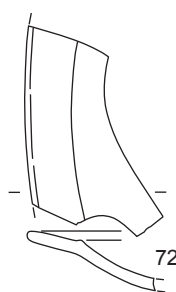

72

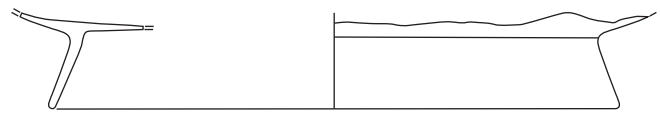

74

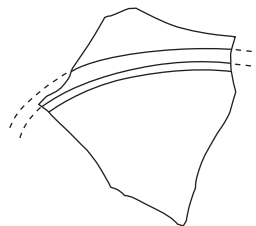

73

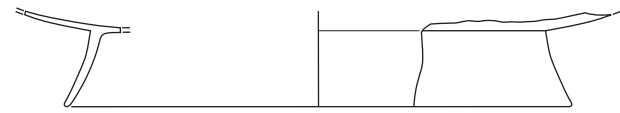

75

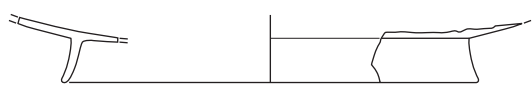

76

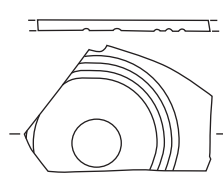

78



77

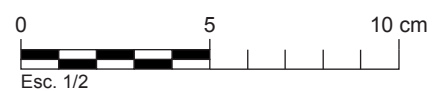

Esc. 1/2

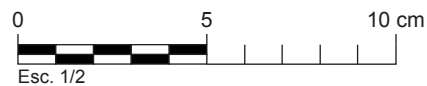
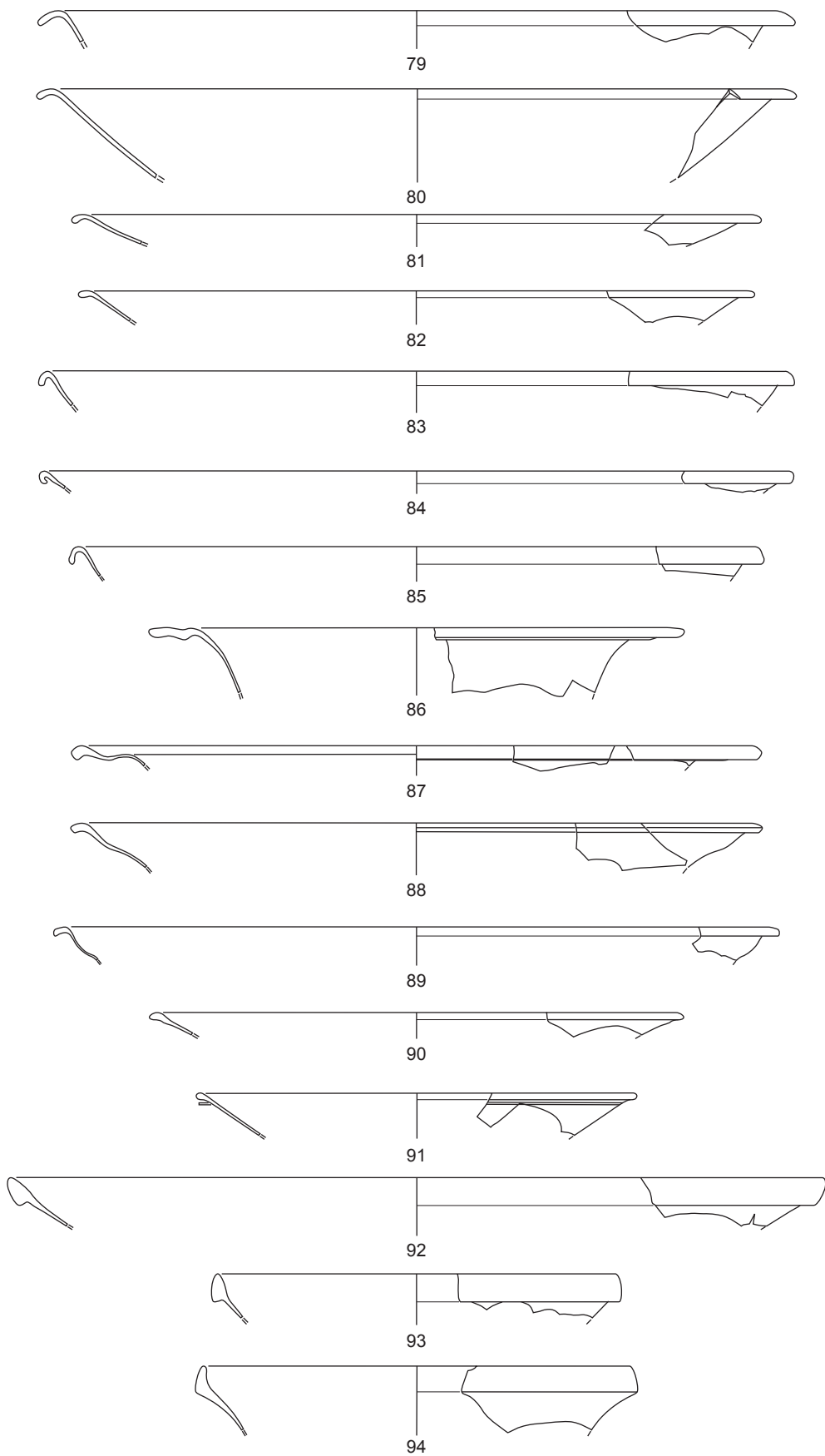

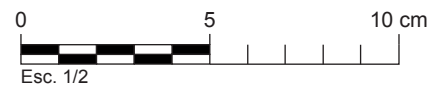
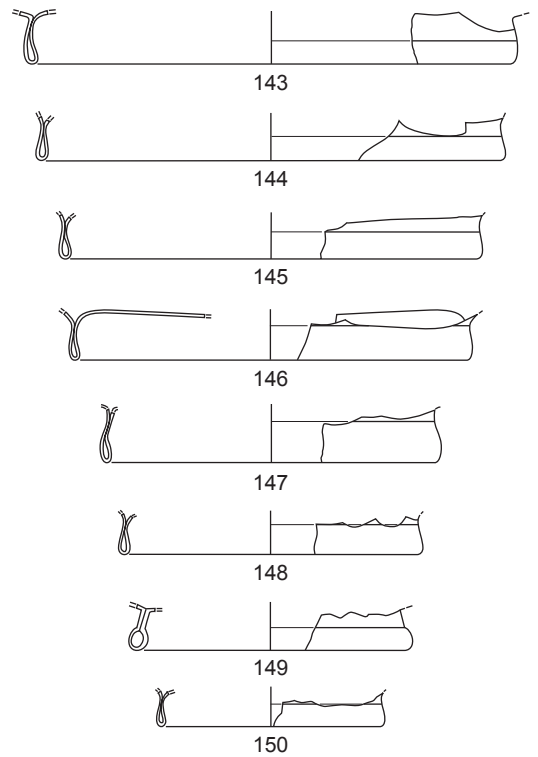
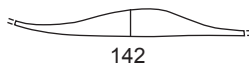
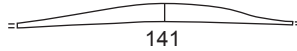
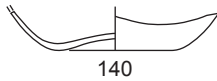
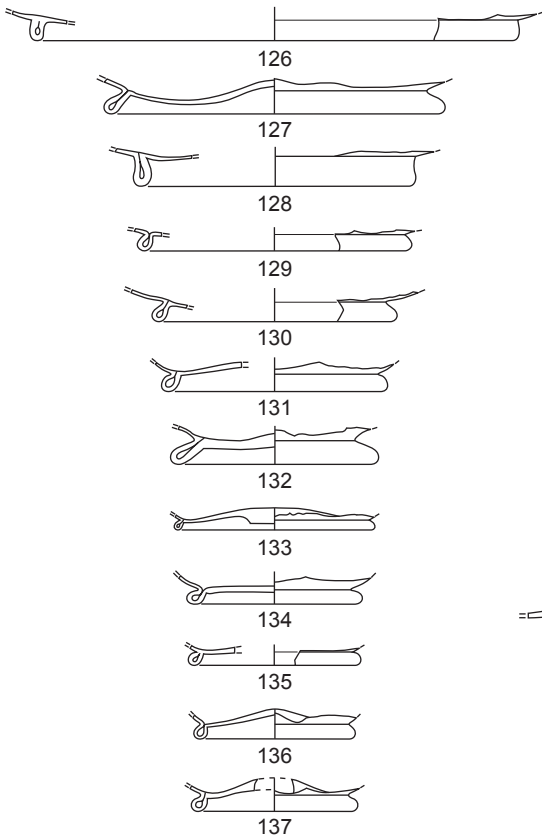
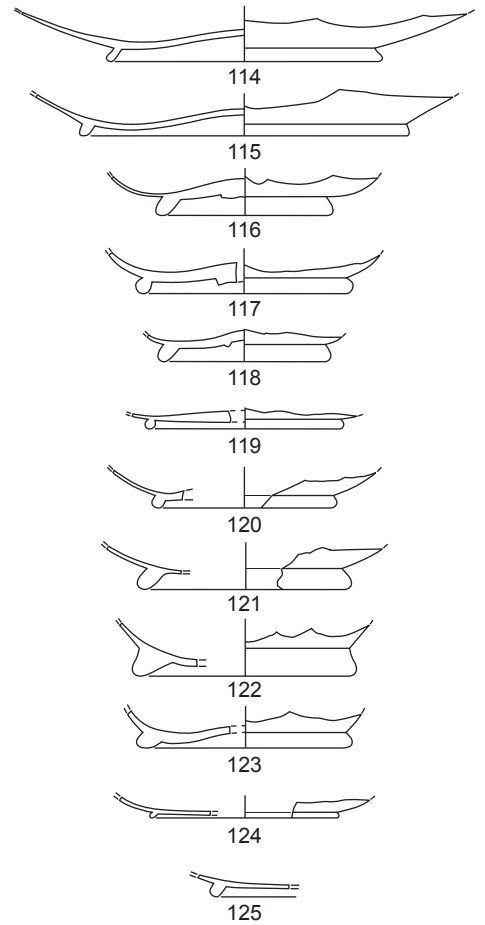
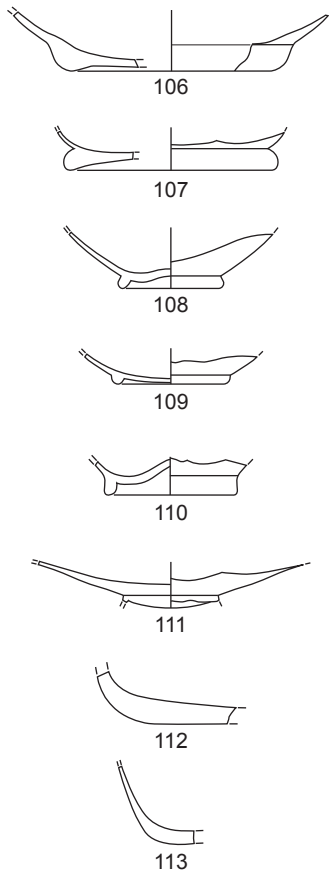
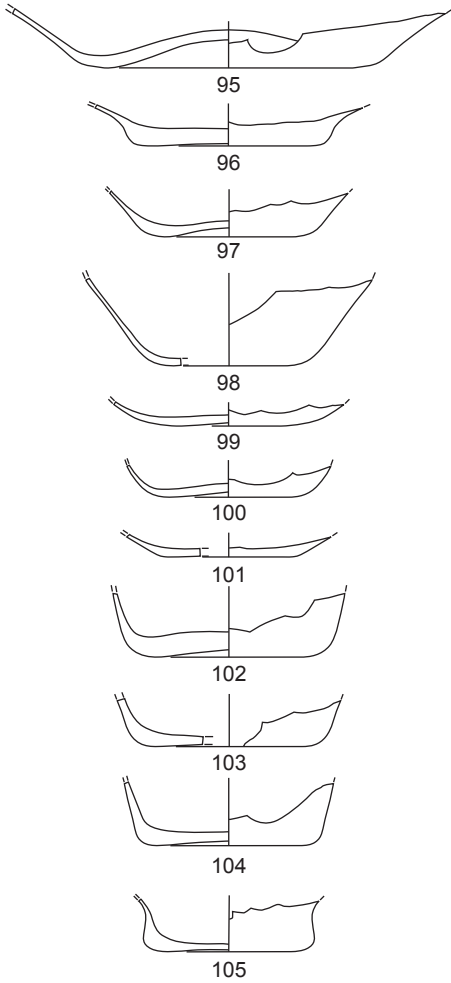



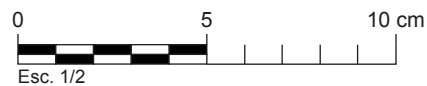
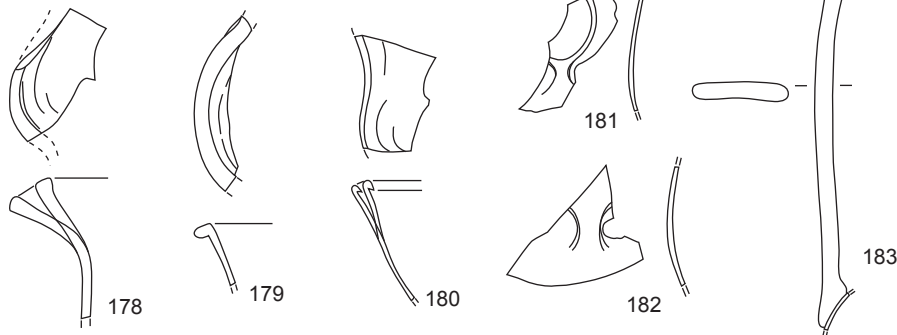
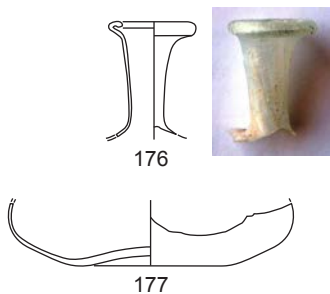
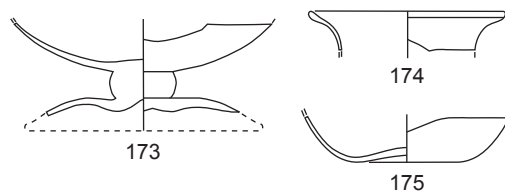
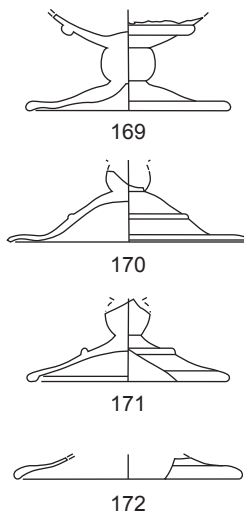
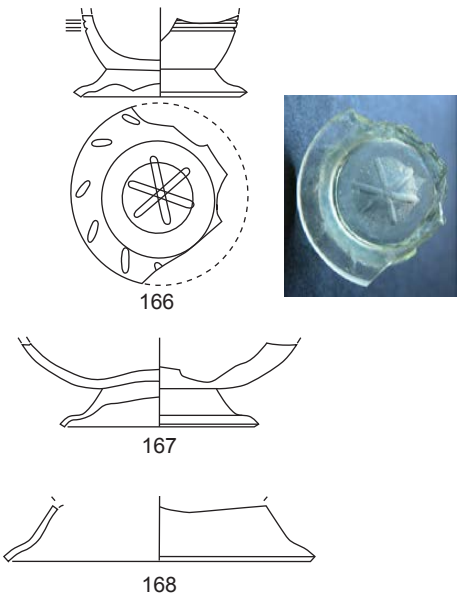
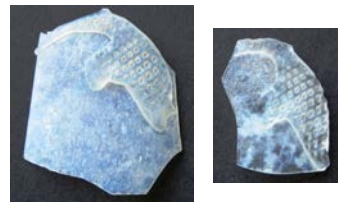
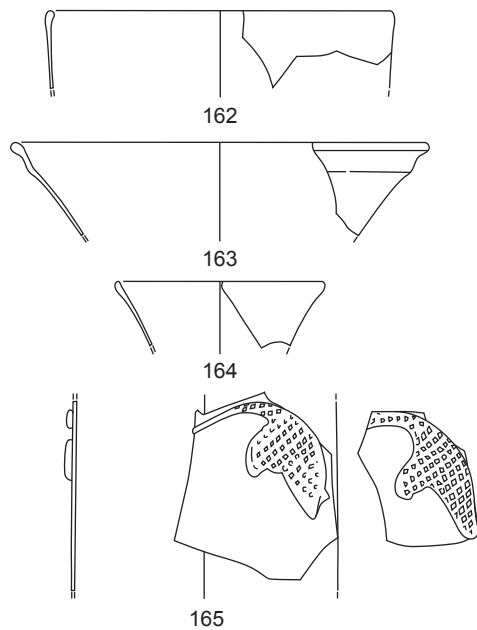
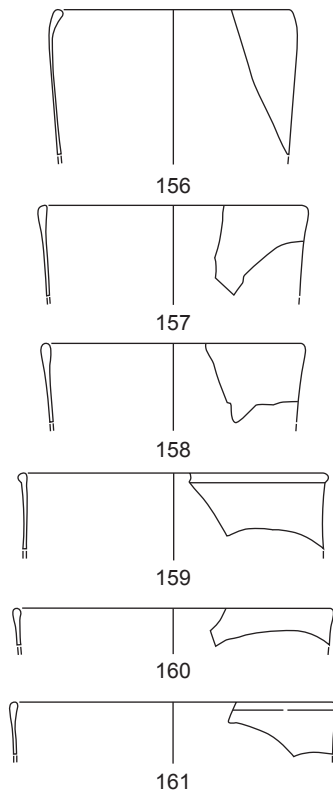
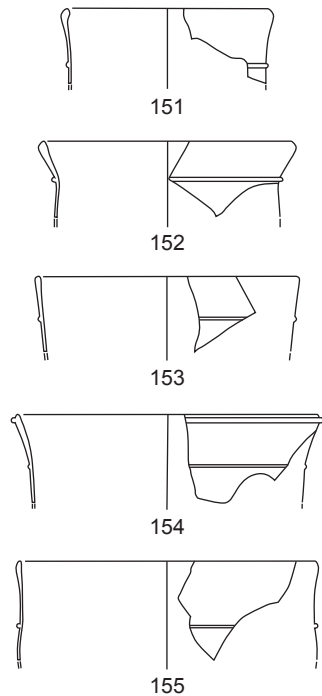

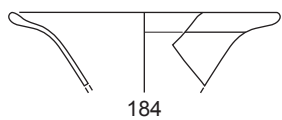

184

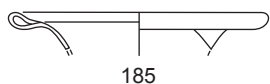

185

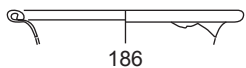

186

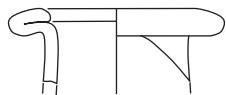

187

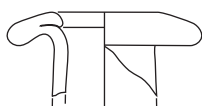

188

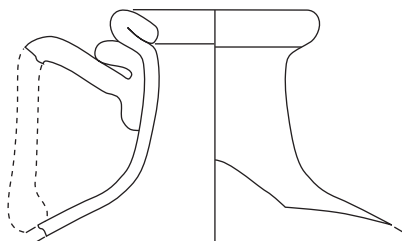

189

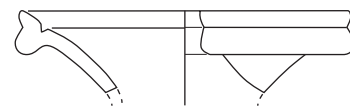

192

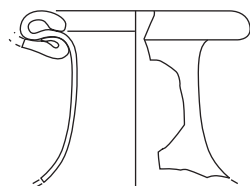

190

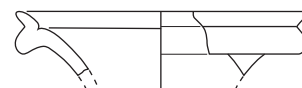

193



191



194

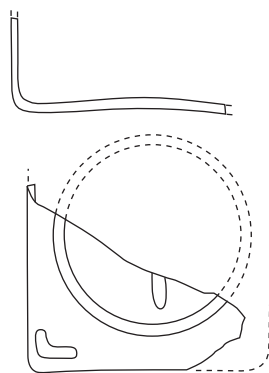
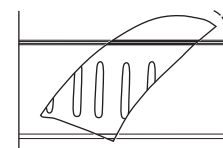

195

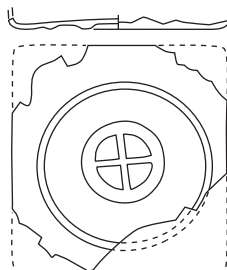

196



197

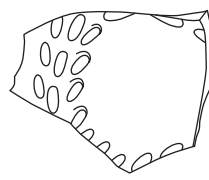

198

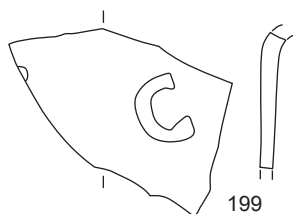
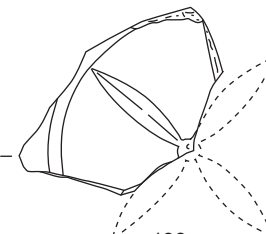

199



200



201

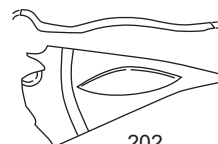
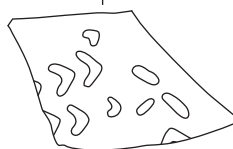

202

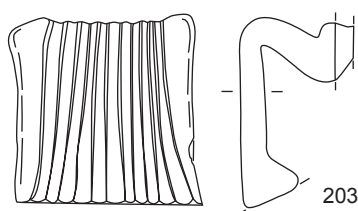

203

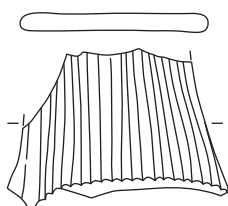

204

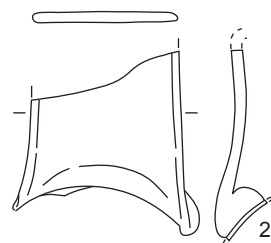

205



206

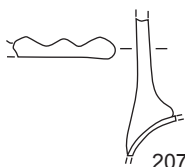

207

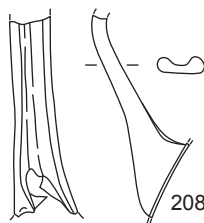

208

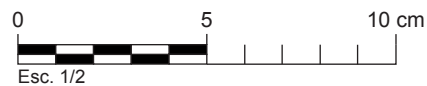

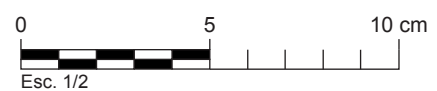
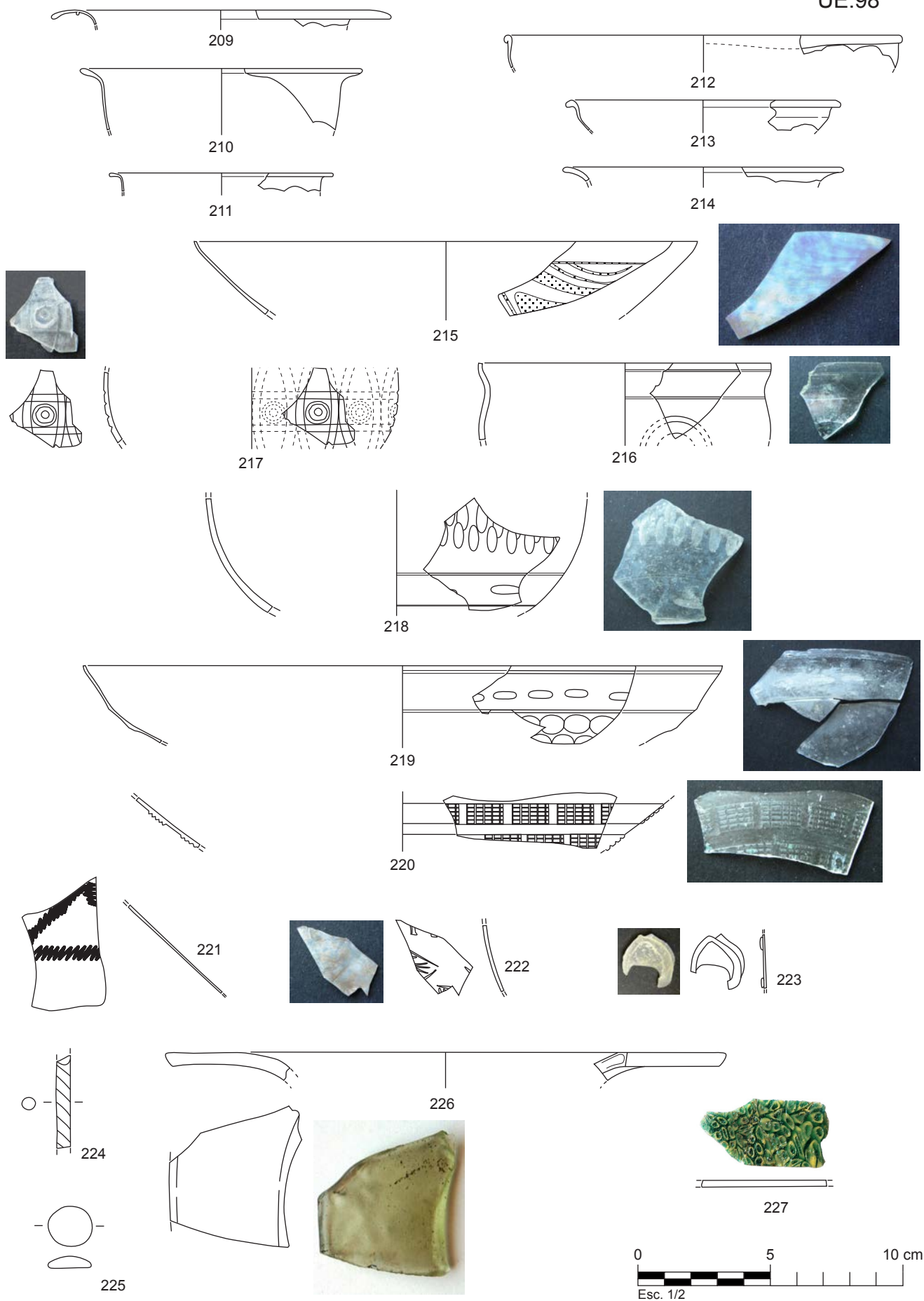

UE.116

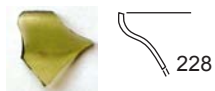

UE.120

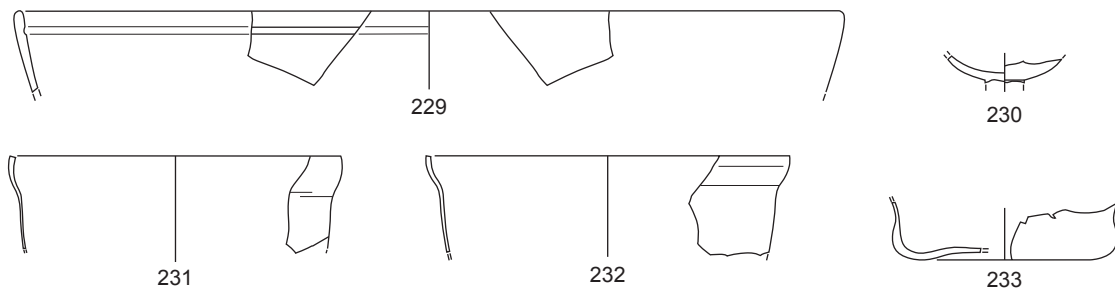

UE.129

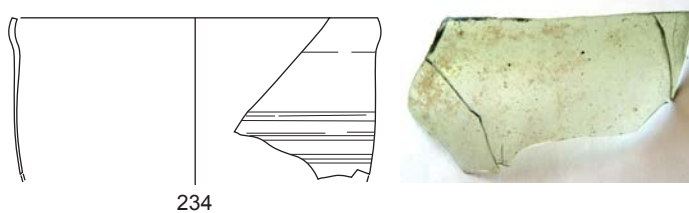

UE.184

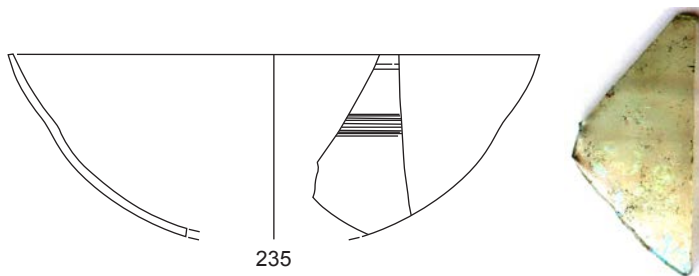

UE.192

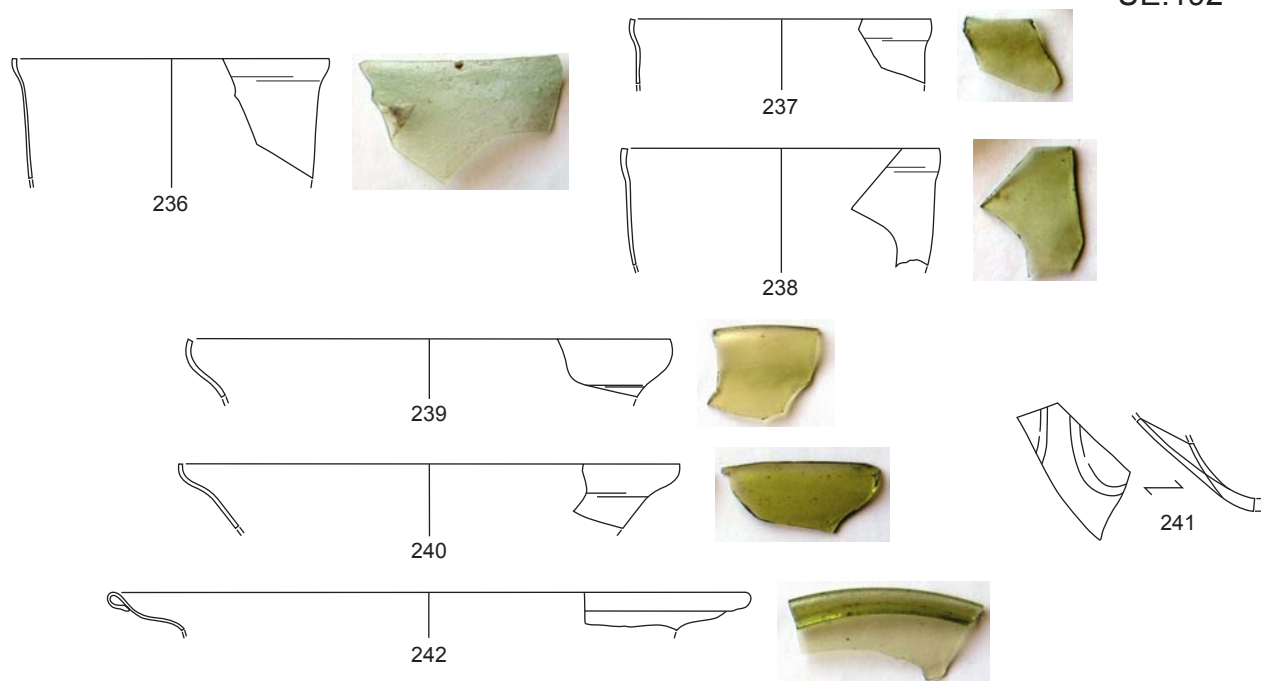

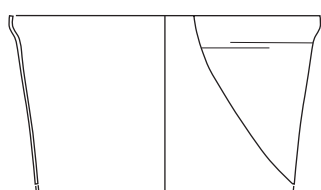
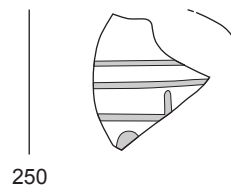
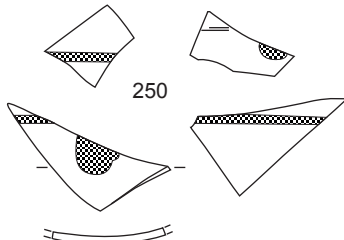
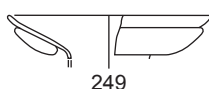
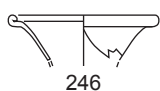
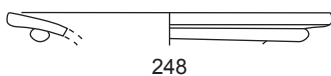
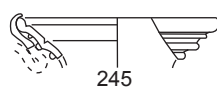
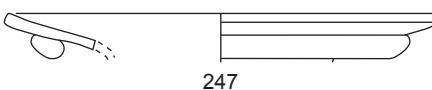
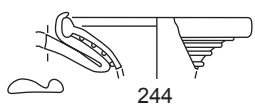

251

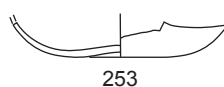

253

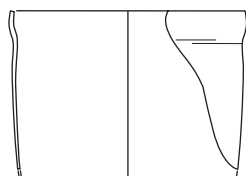
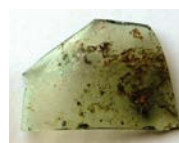

252

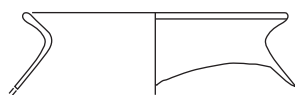

254

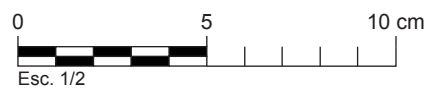

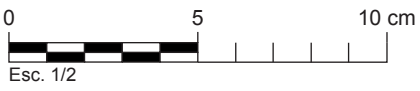
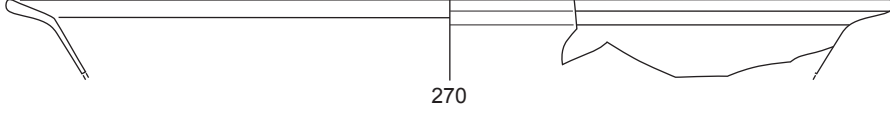
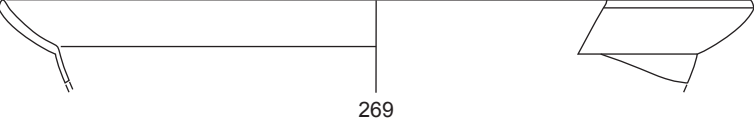
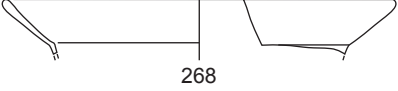
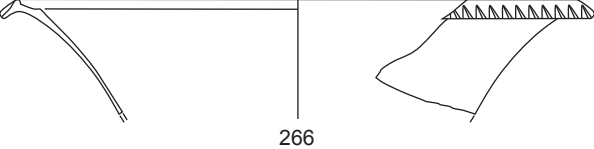
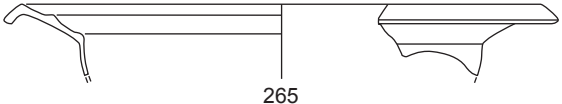
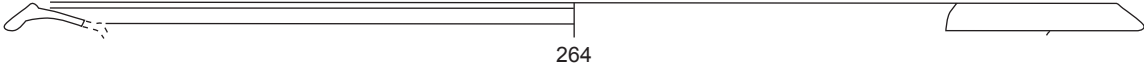
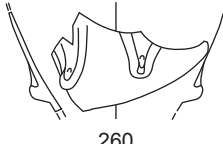
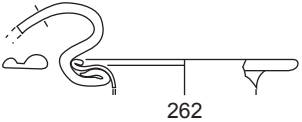
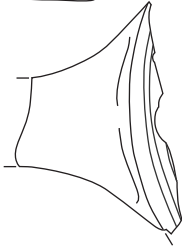
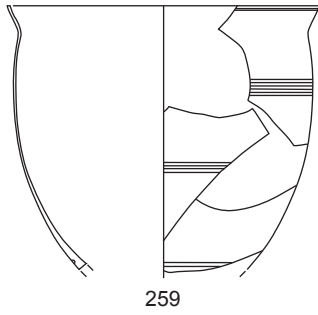
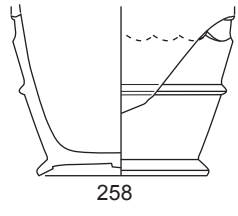
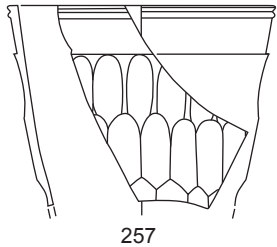
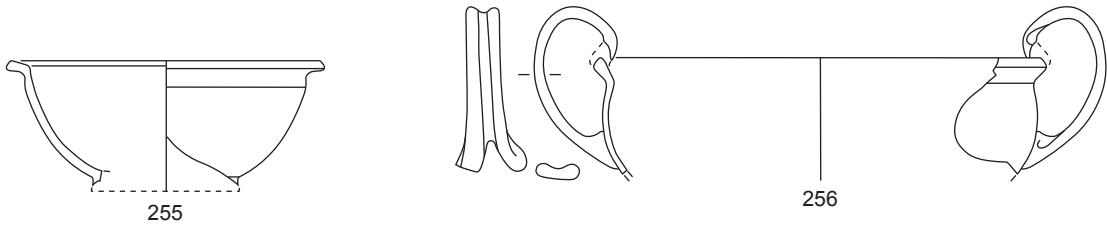

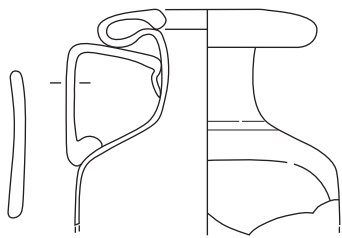

271

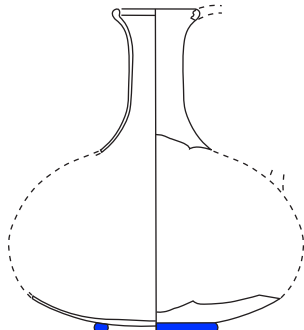

273

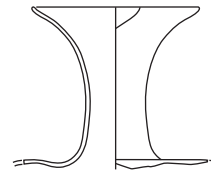

274

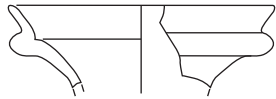

272

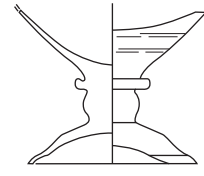

275

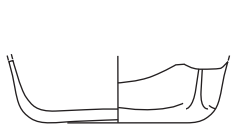
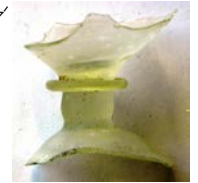

276

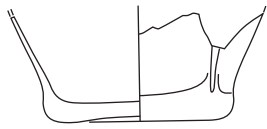

277

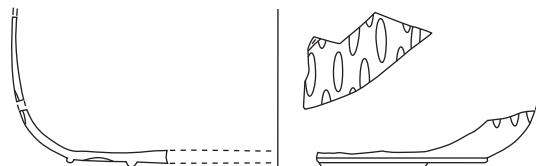
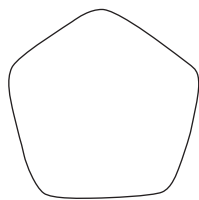
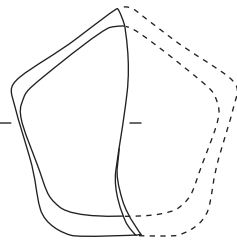

278

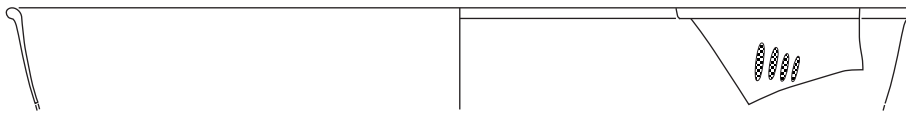
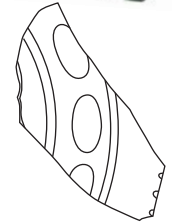

279



280

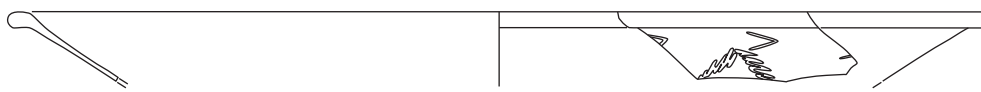

281

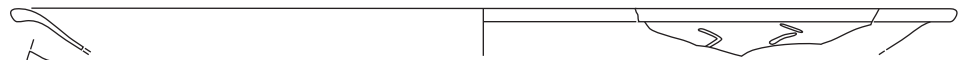

282

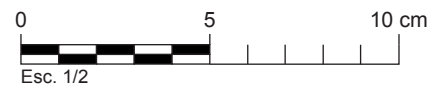

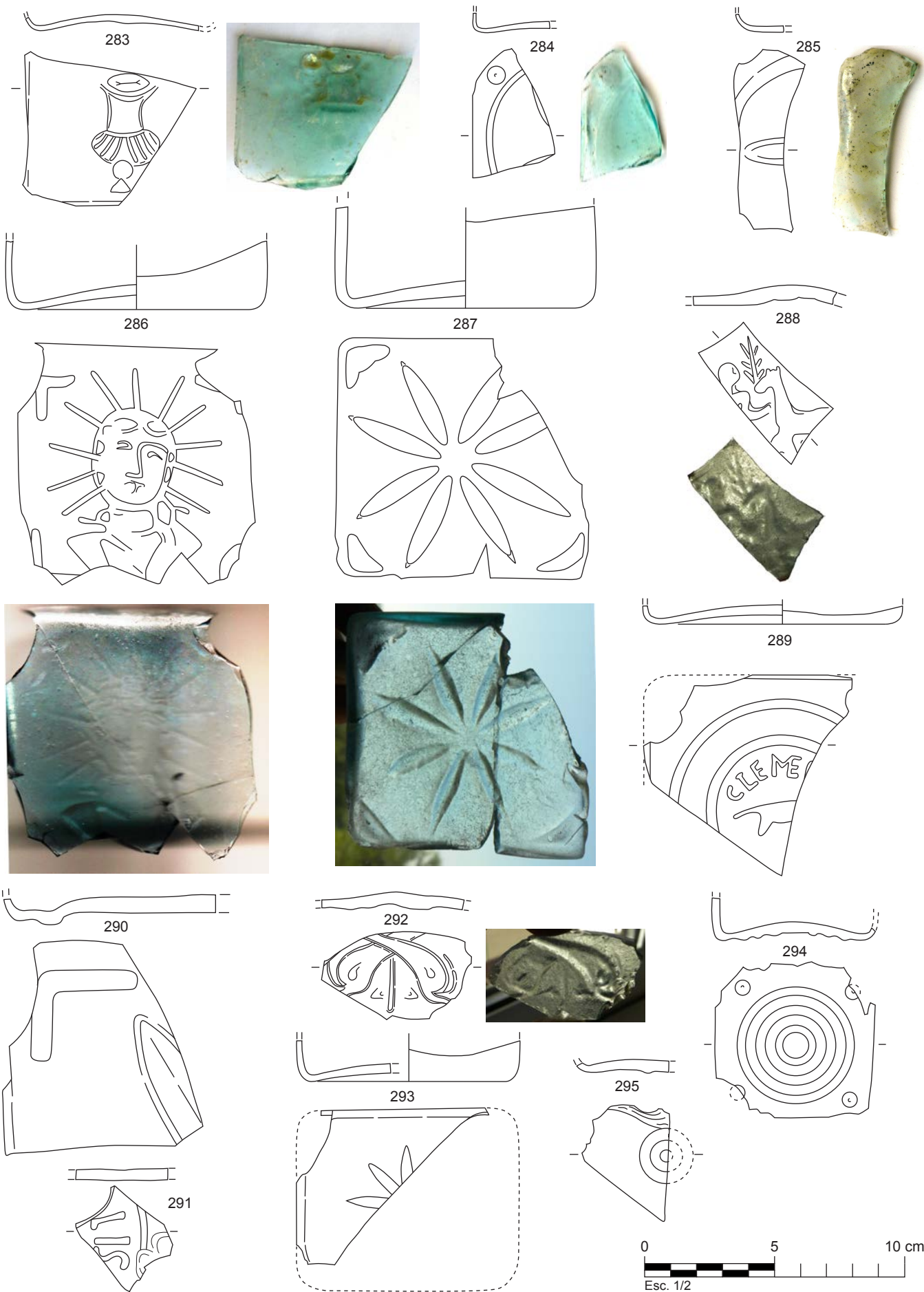

CARRER CASTANYOS (Tarragona, Tarragonès), 1999  
 Miscel·lània: Ues. 122, 160, 163, 179, 207, 216, 217, 218, 229 i 231  
 Cronologia: s.II-III

LÀMINA 308



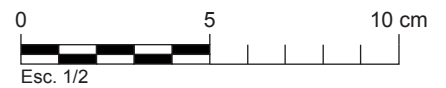
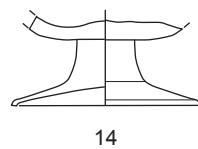
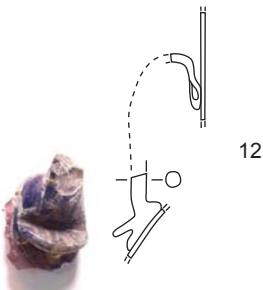
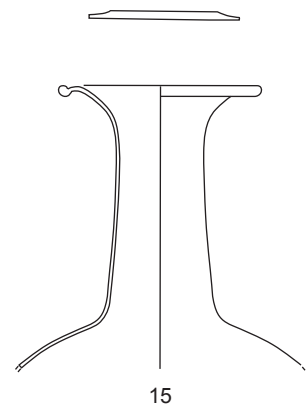
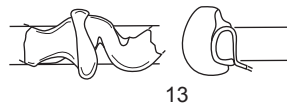
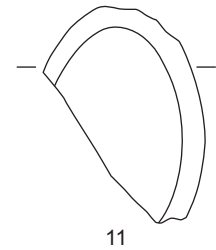
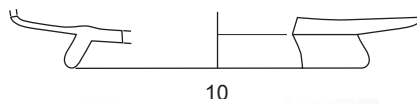
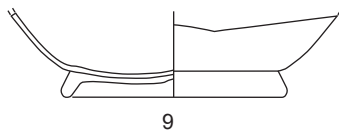
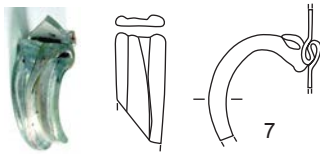
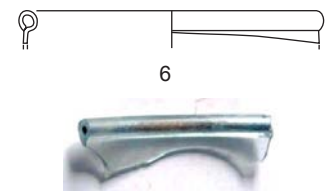
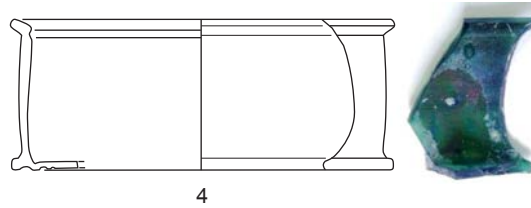
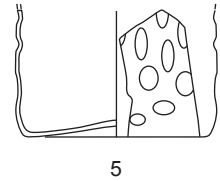
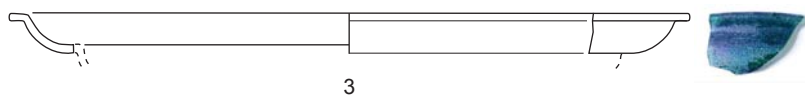
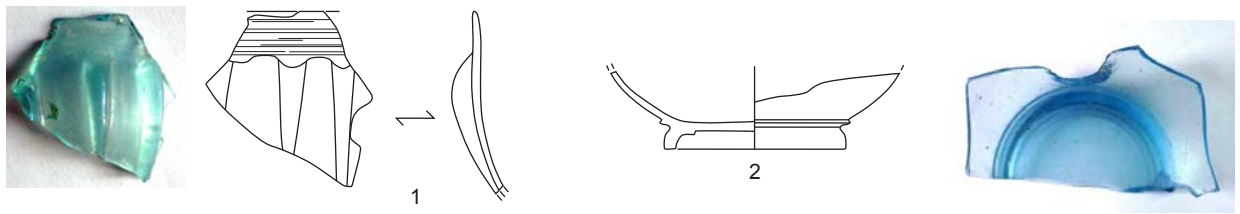

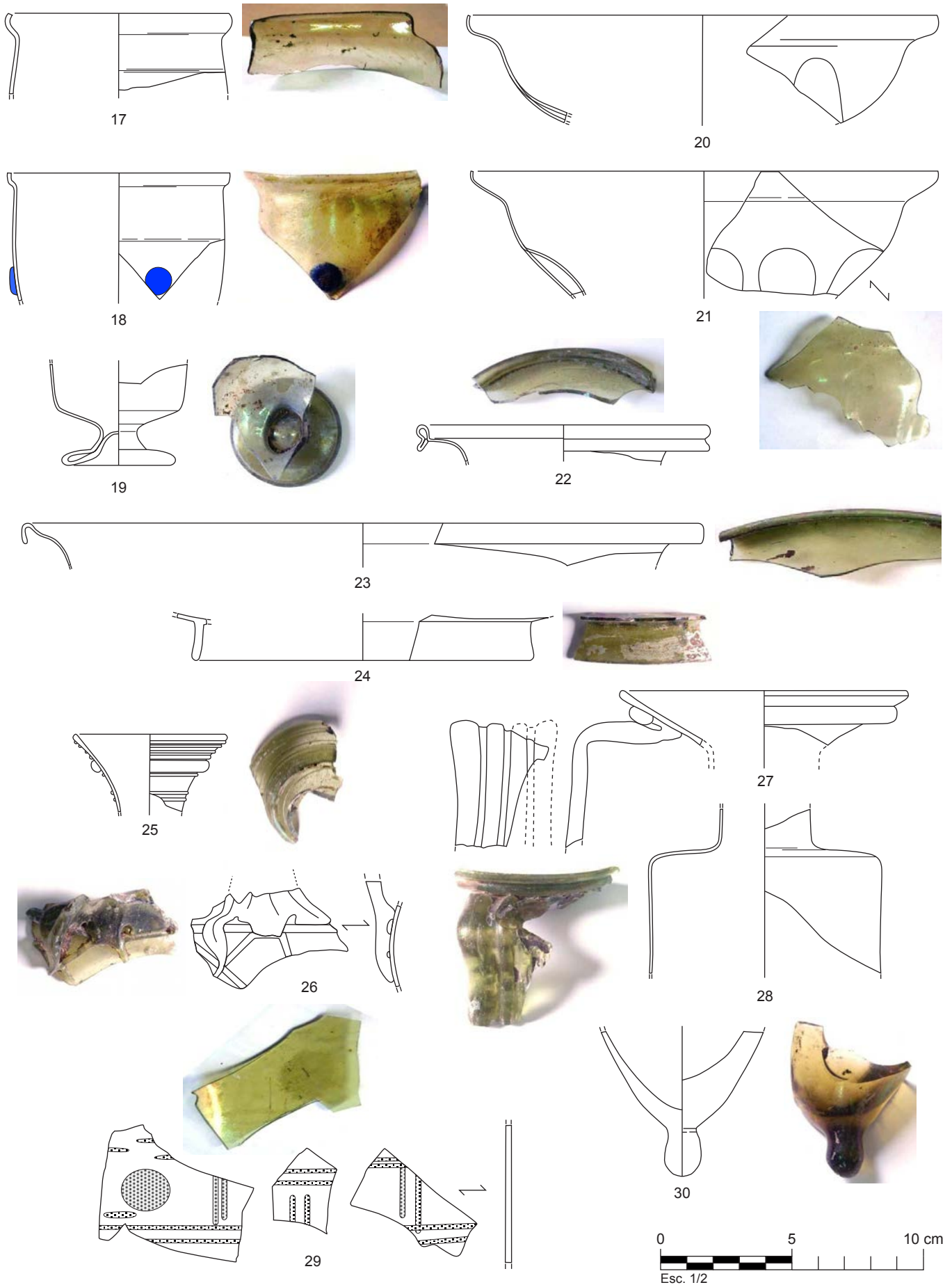

JARDÍ DEL CLAUSTRE DE LA CATEDRAL (Tarragona, Tarragonès), 1955

Nivells D, E i F (Reelaborat a partir de J. PRICE 1981. Fotografies del Museu Diocesà de Tarragona).

Cronologia: s.V

LÀMINA 310

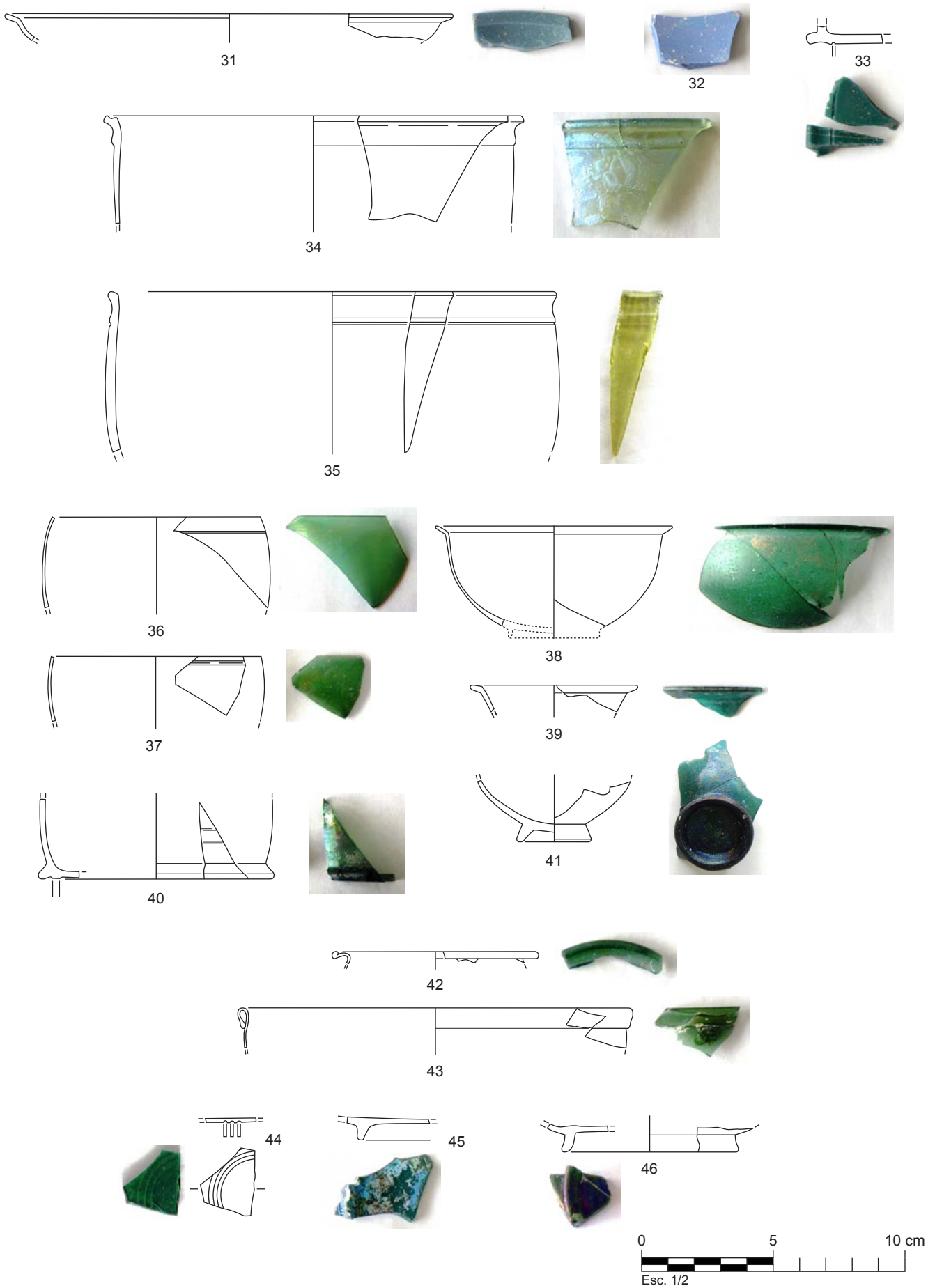

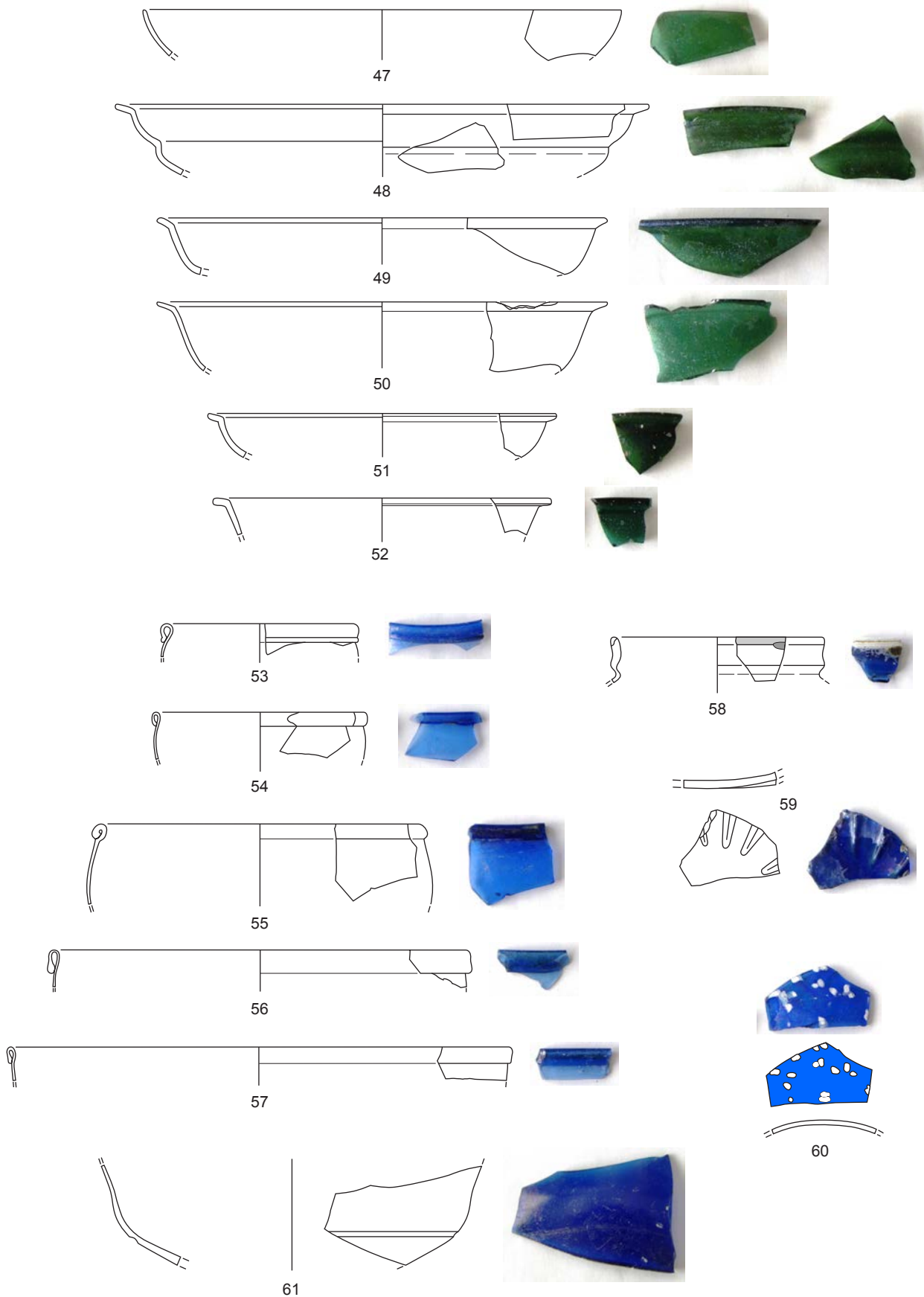

0 5 10 cm  
Esc. 1/2

JARDÍ DEL CLAUSTRE DE LA CATEDRAL (Tarragona, Tarragonès), 1955  
Nivells G i H  
Cronologia: s. I

LÀMINA 312

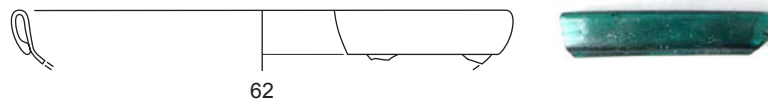

62

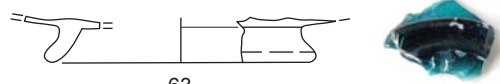

63

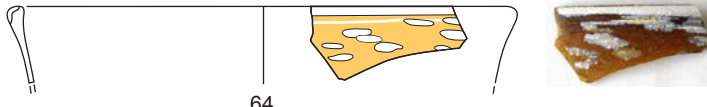

64

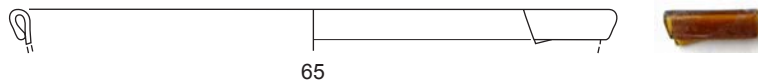

65

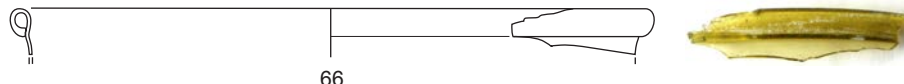

66

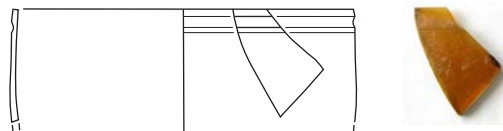

67

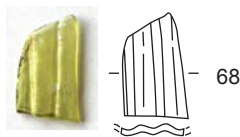

68

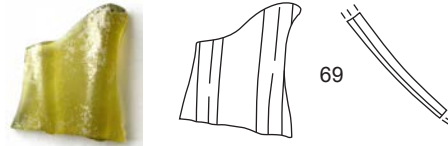

69

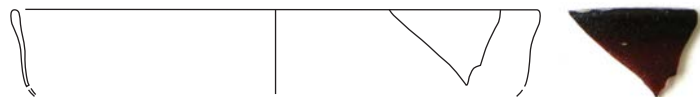

70

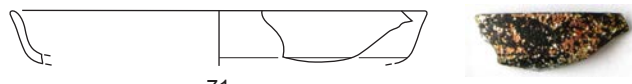

71

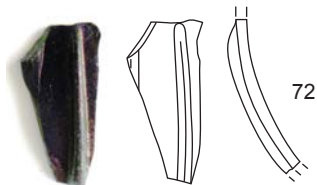

72



73

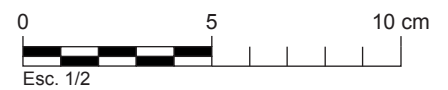

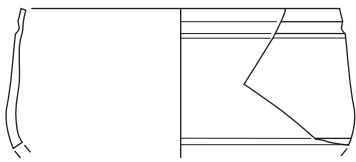

74

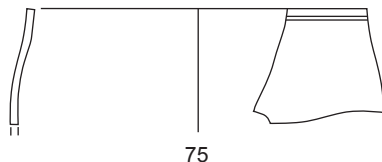

75

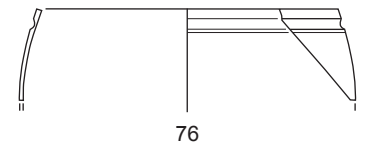

76

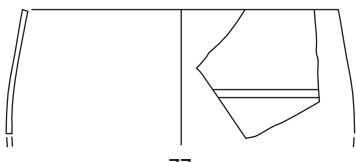

77

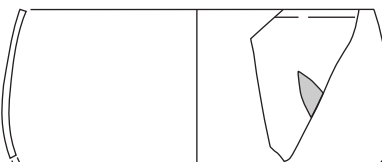

78



79

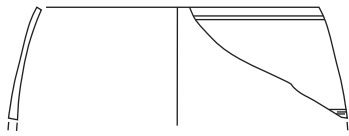

80

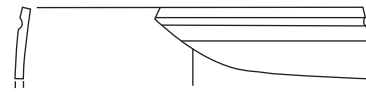

81

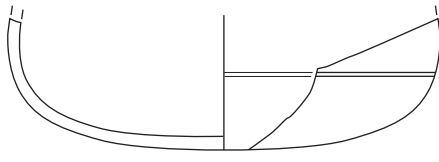

82

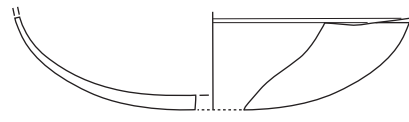

84

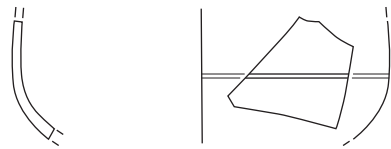

83



85

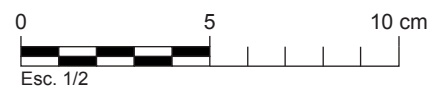

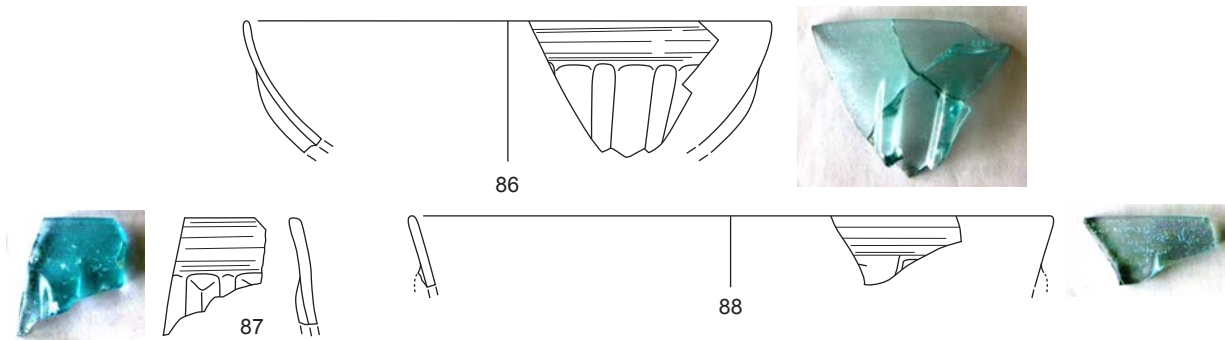

Fragments de bols de costelles Isings 3

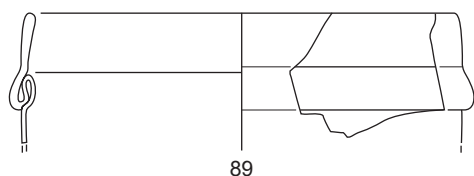

89

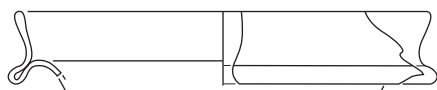

90

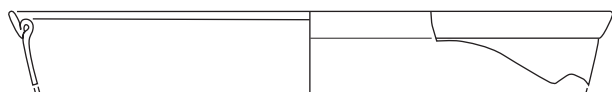

91

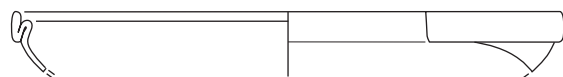

92



93

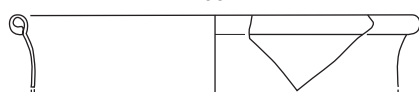

94



95

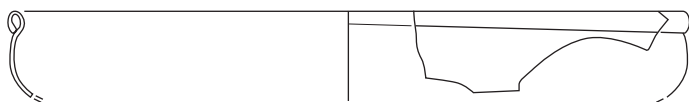

96

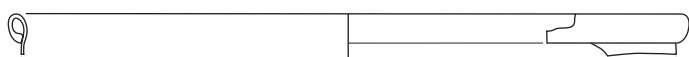

97

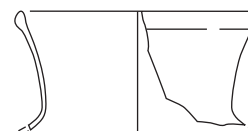

98

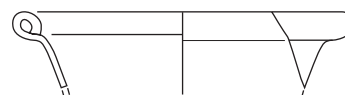

99



100

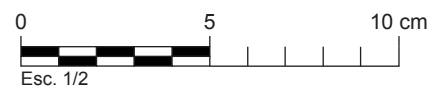

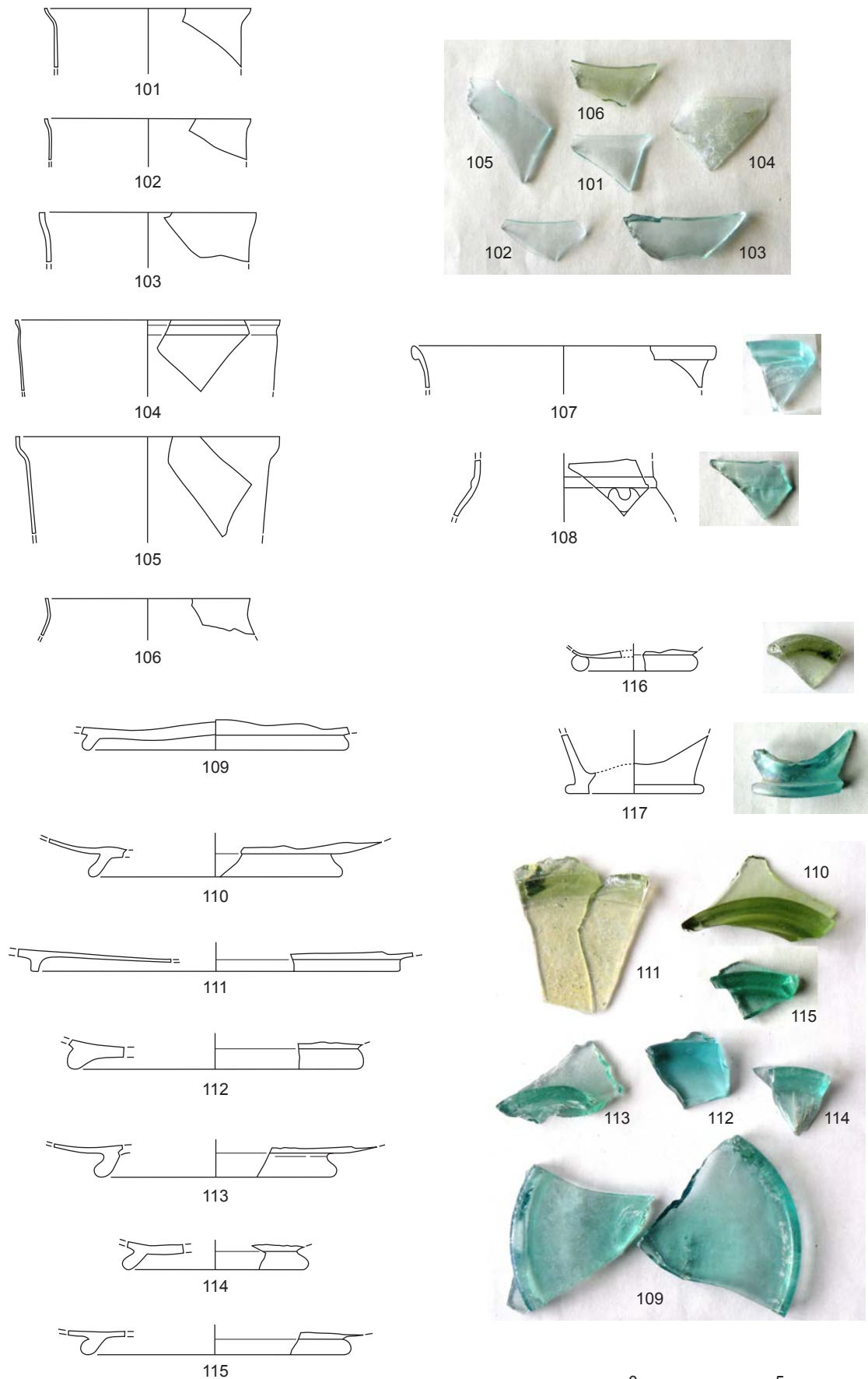



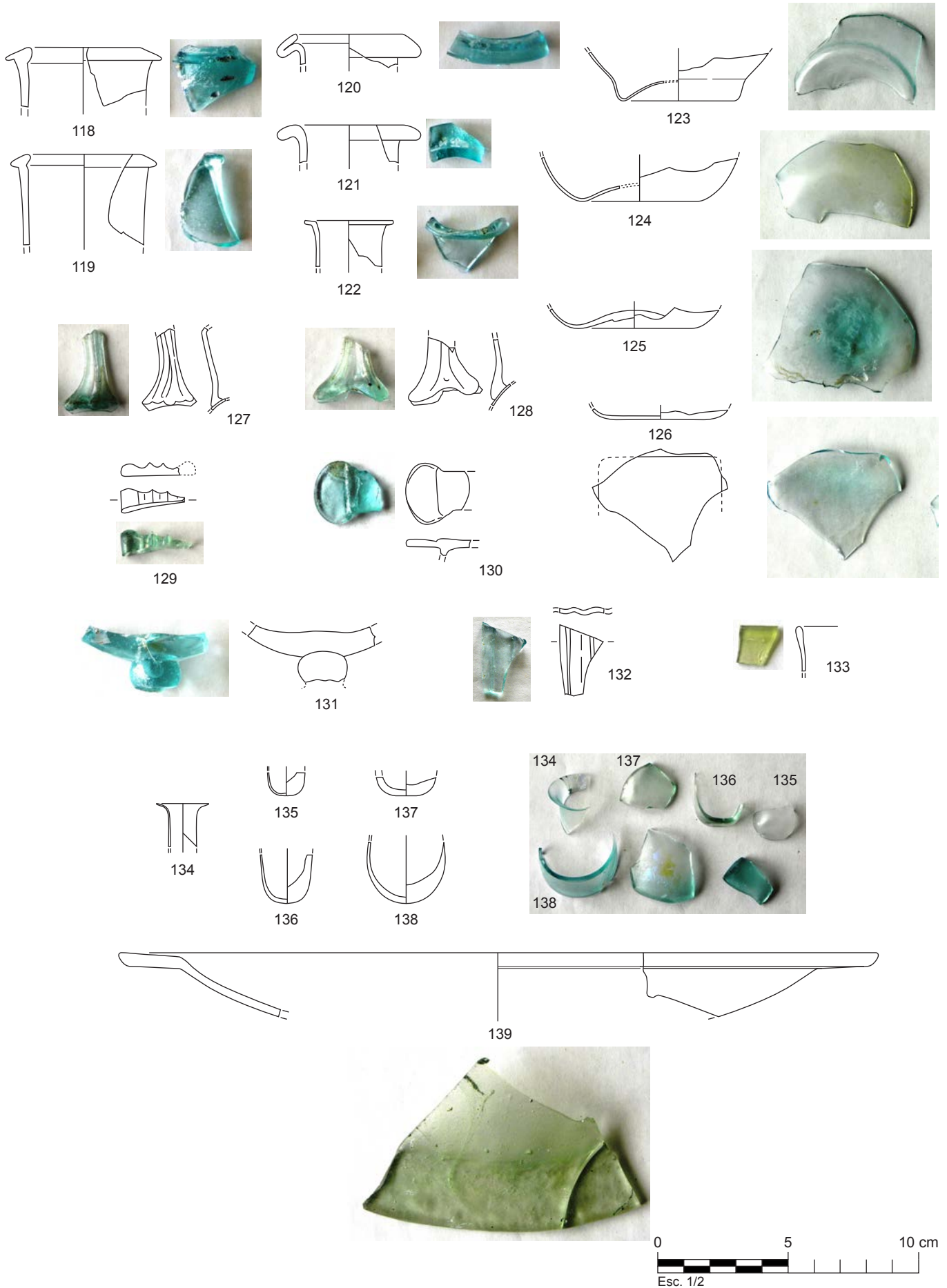

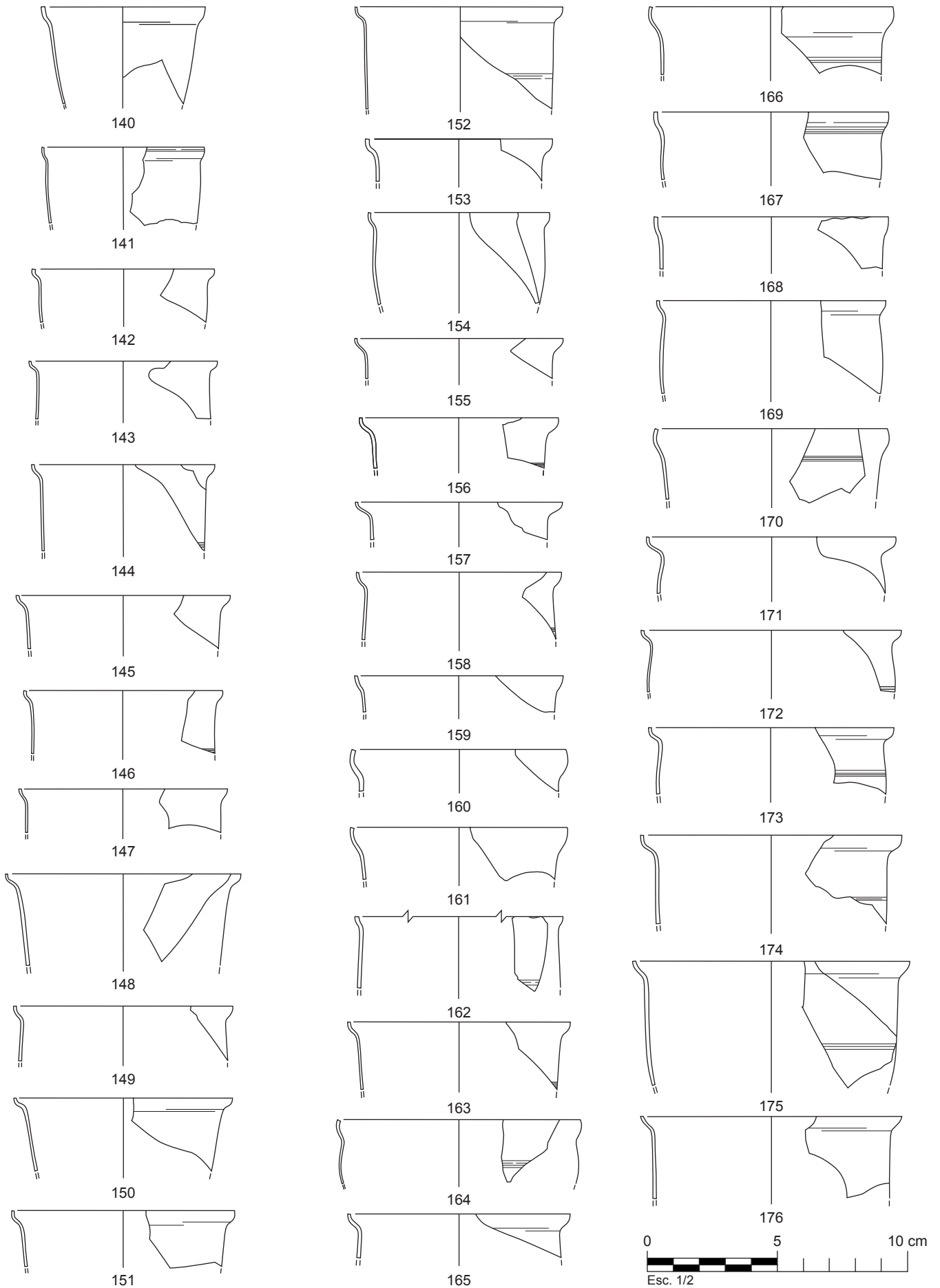

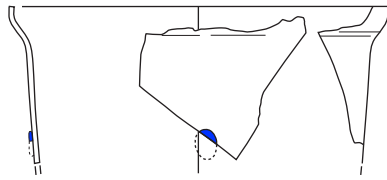

177

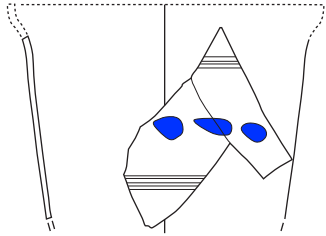

178

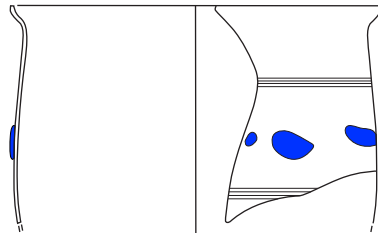

179



Fragments de gots Isings 96  
amb gotes blaves

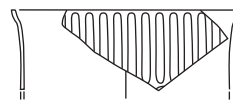

180

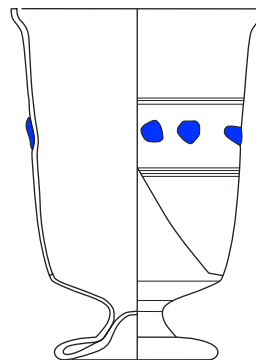

181



182

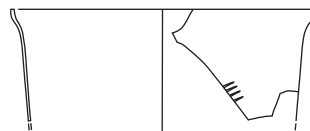

183



184

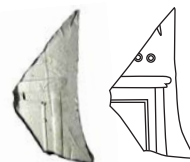

185

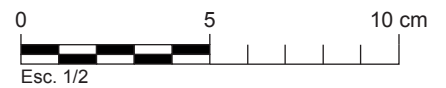

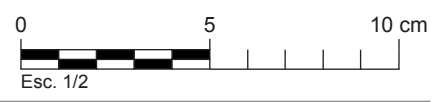
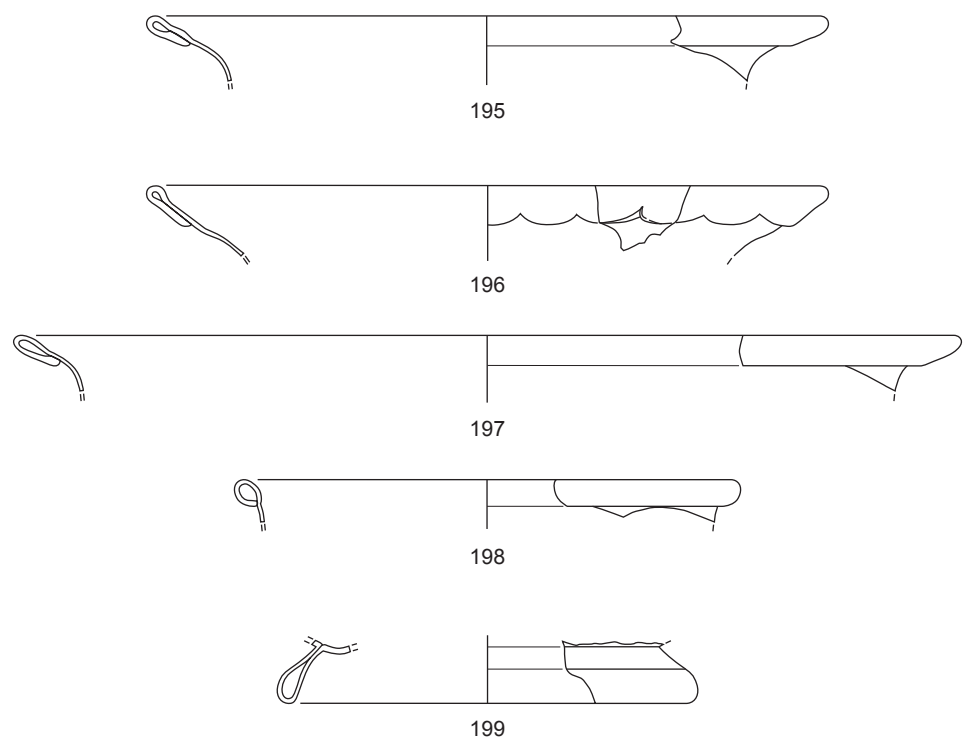
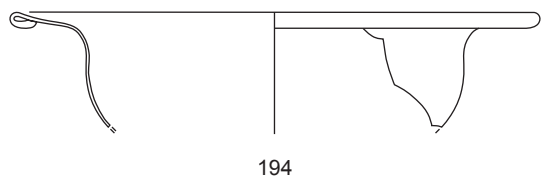
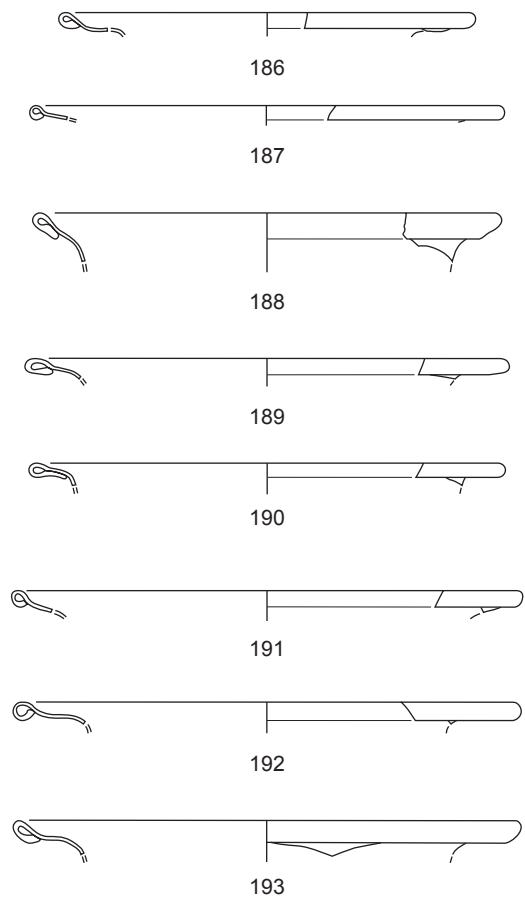

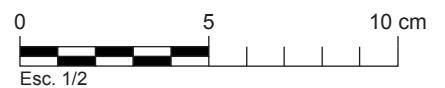
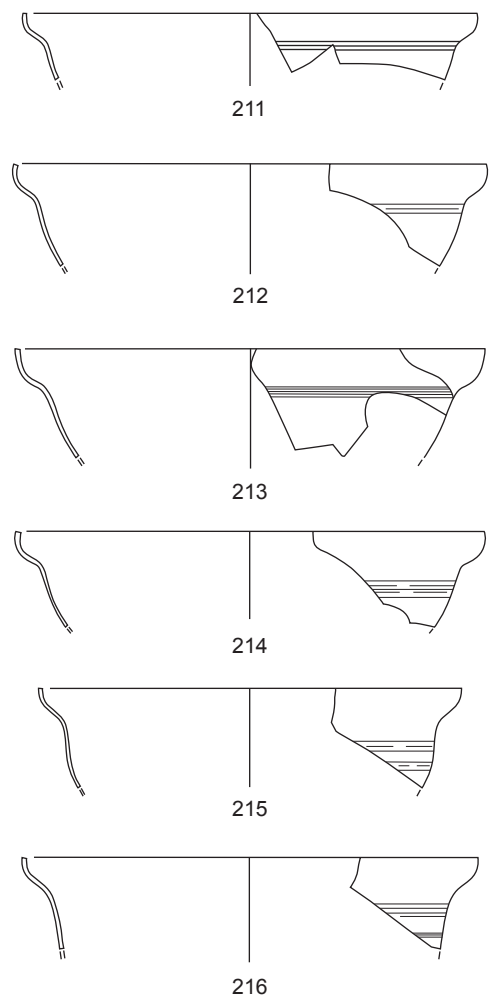
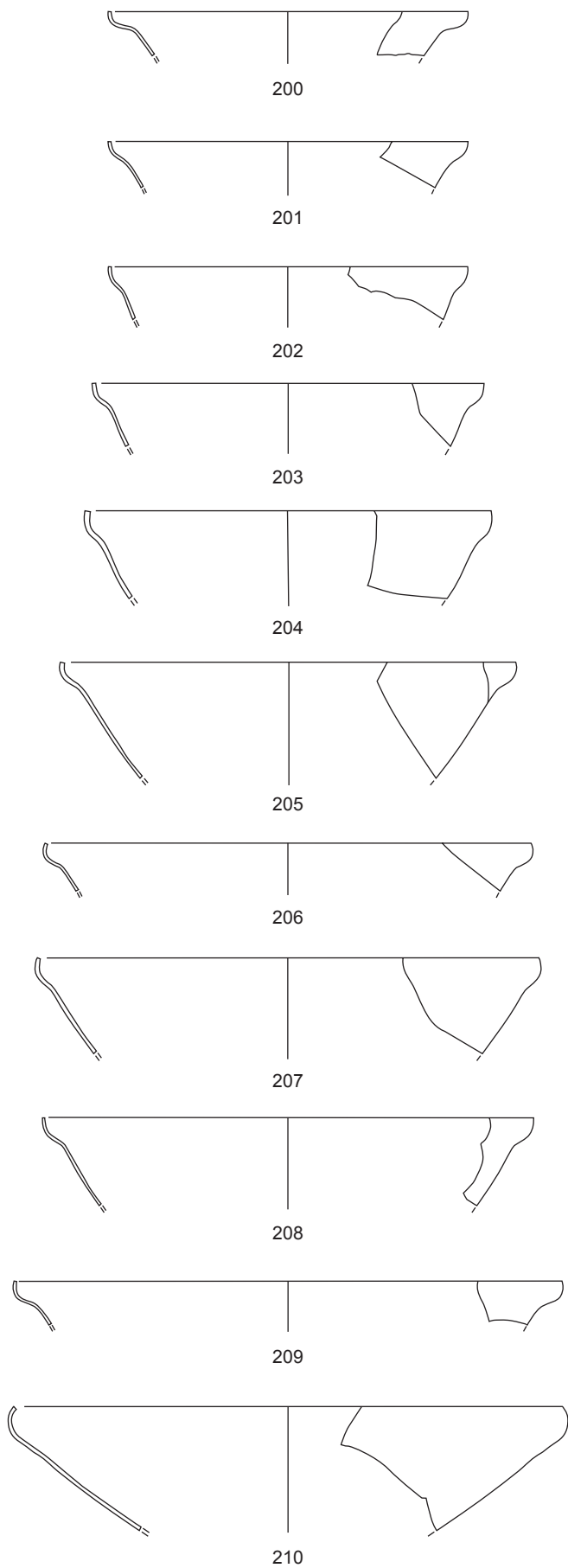

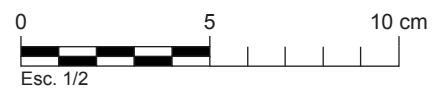
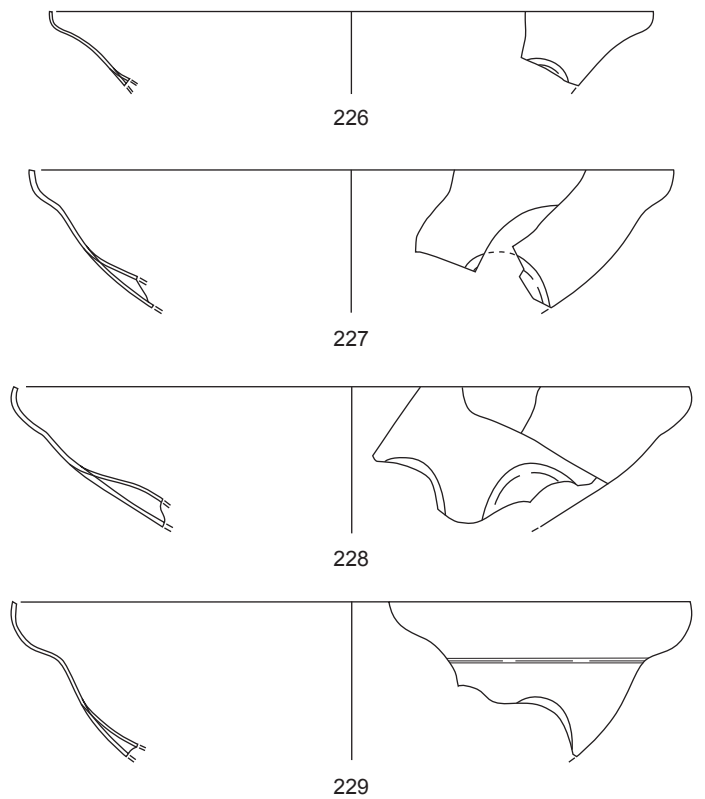
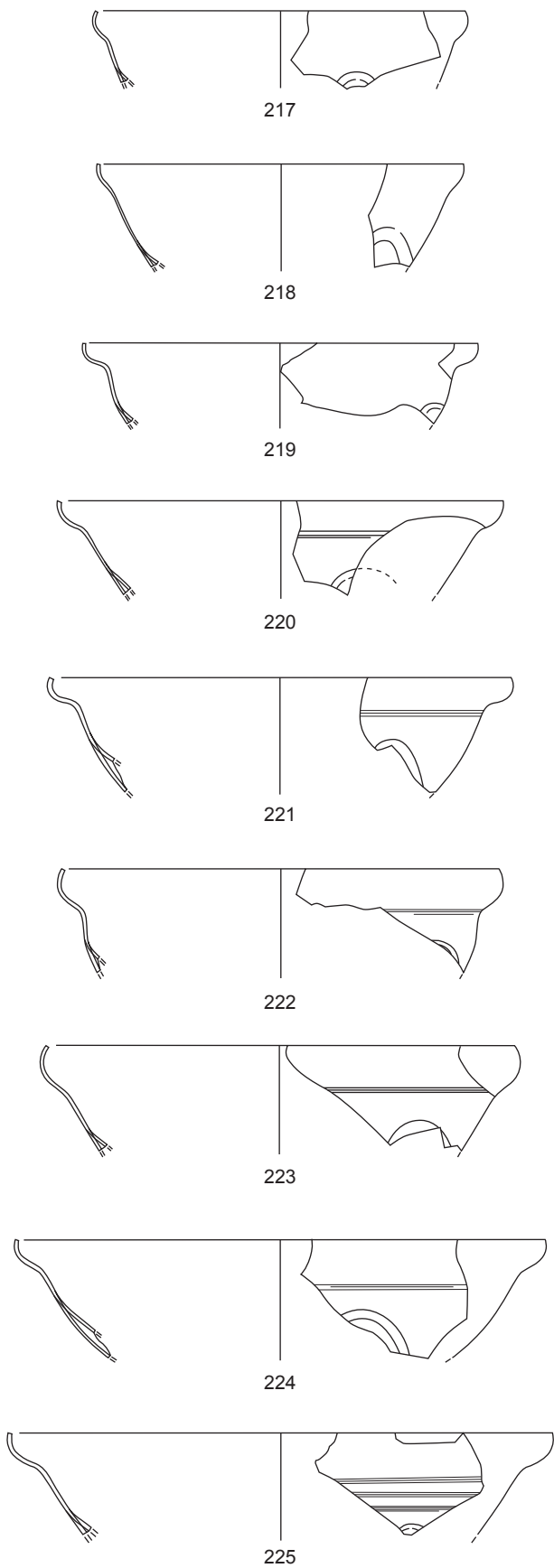



Escudelles Isings 116/117  
verdoses



Escudelles Isings 116/117  
incolores

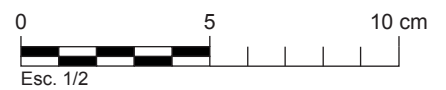

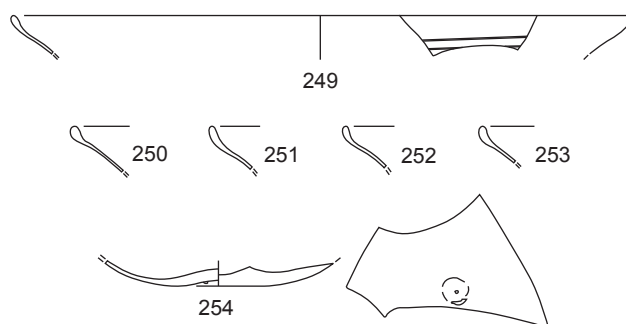
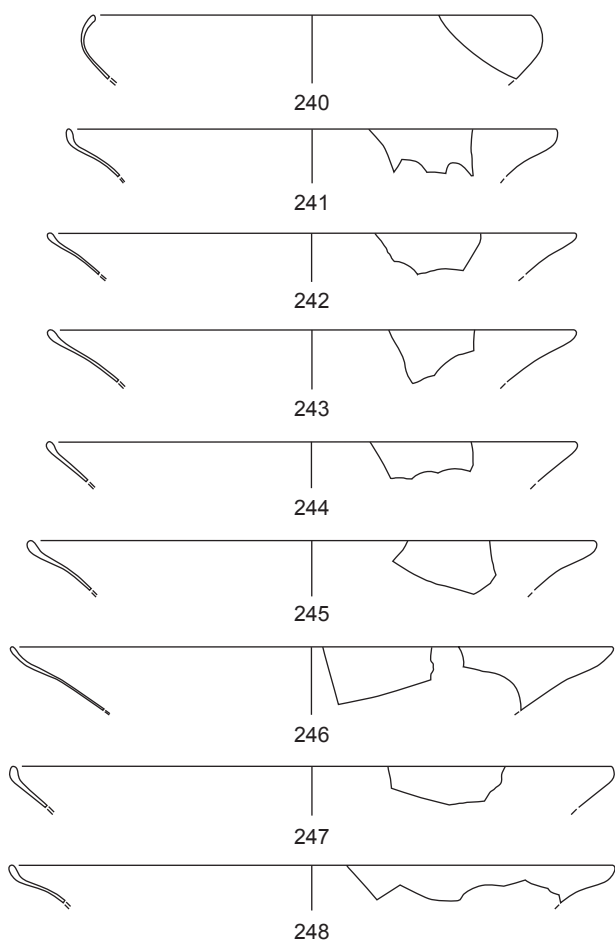
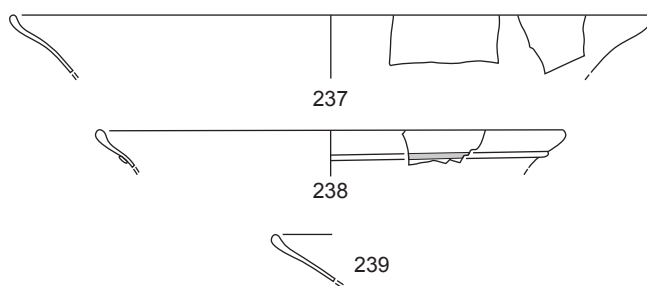
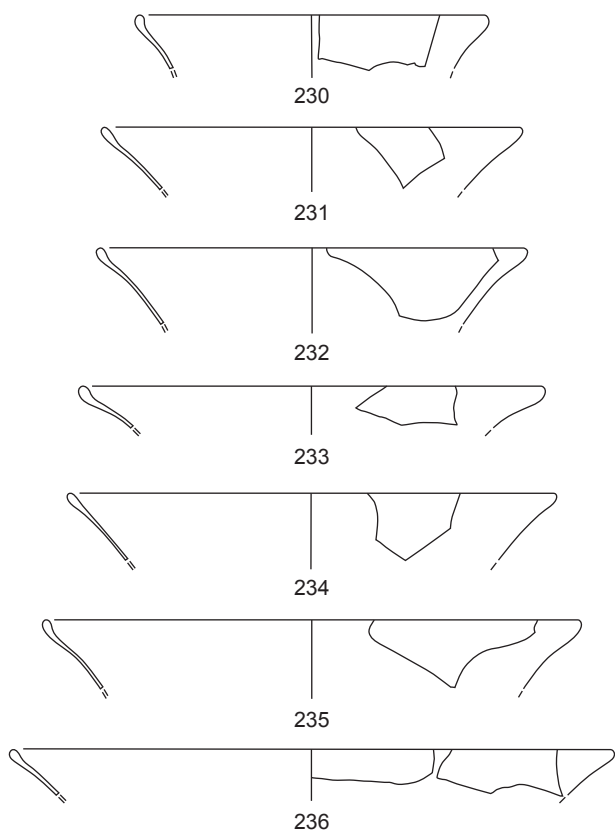



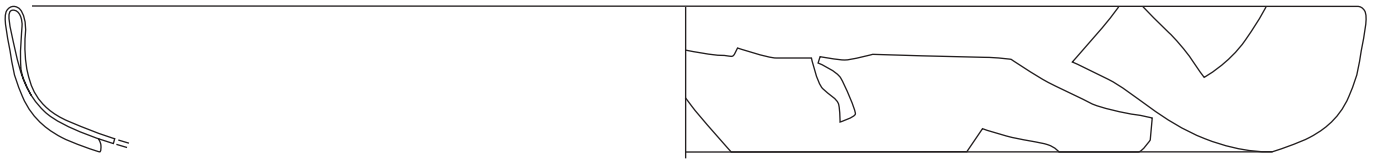

255



256



257

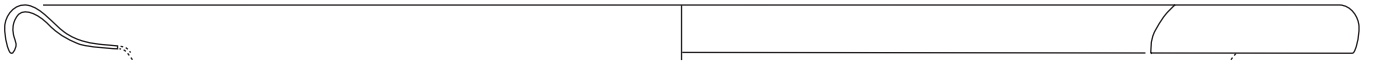

258



259

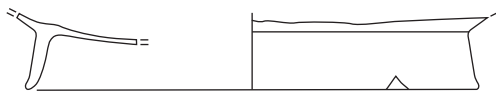

260



261



263



262

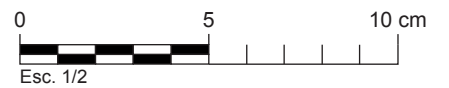

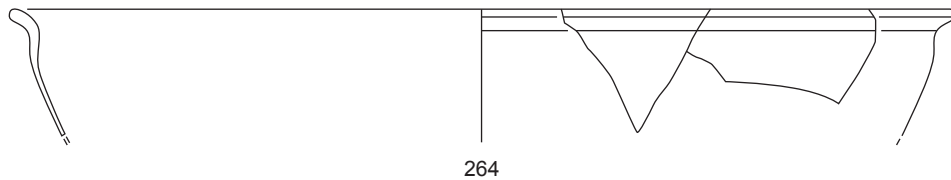

264

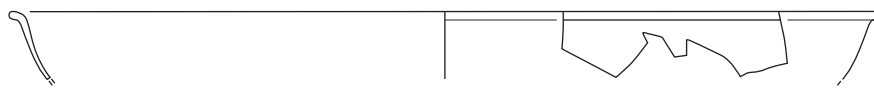

265

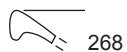

268



266



267

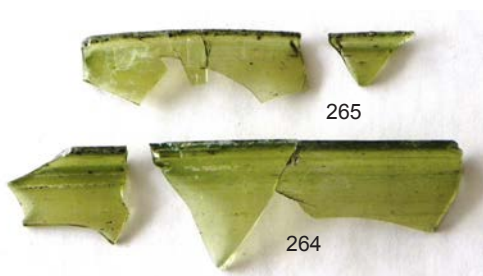

265

264



268

267

266

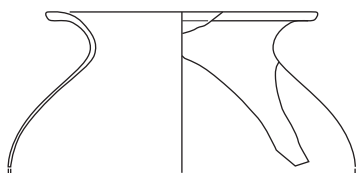

269



272

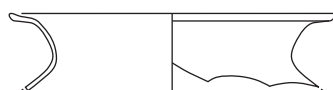

273



270

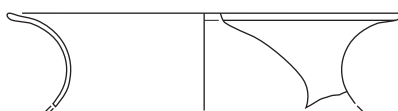

274



271



271

269

274

273

270

269

270

272

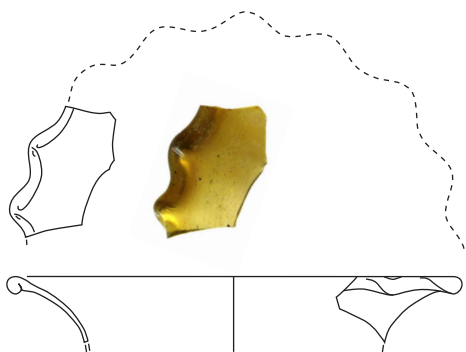

275

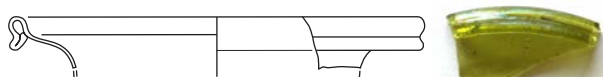

276



277



278

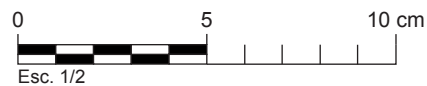

Esc. 1/2

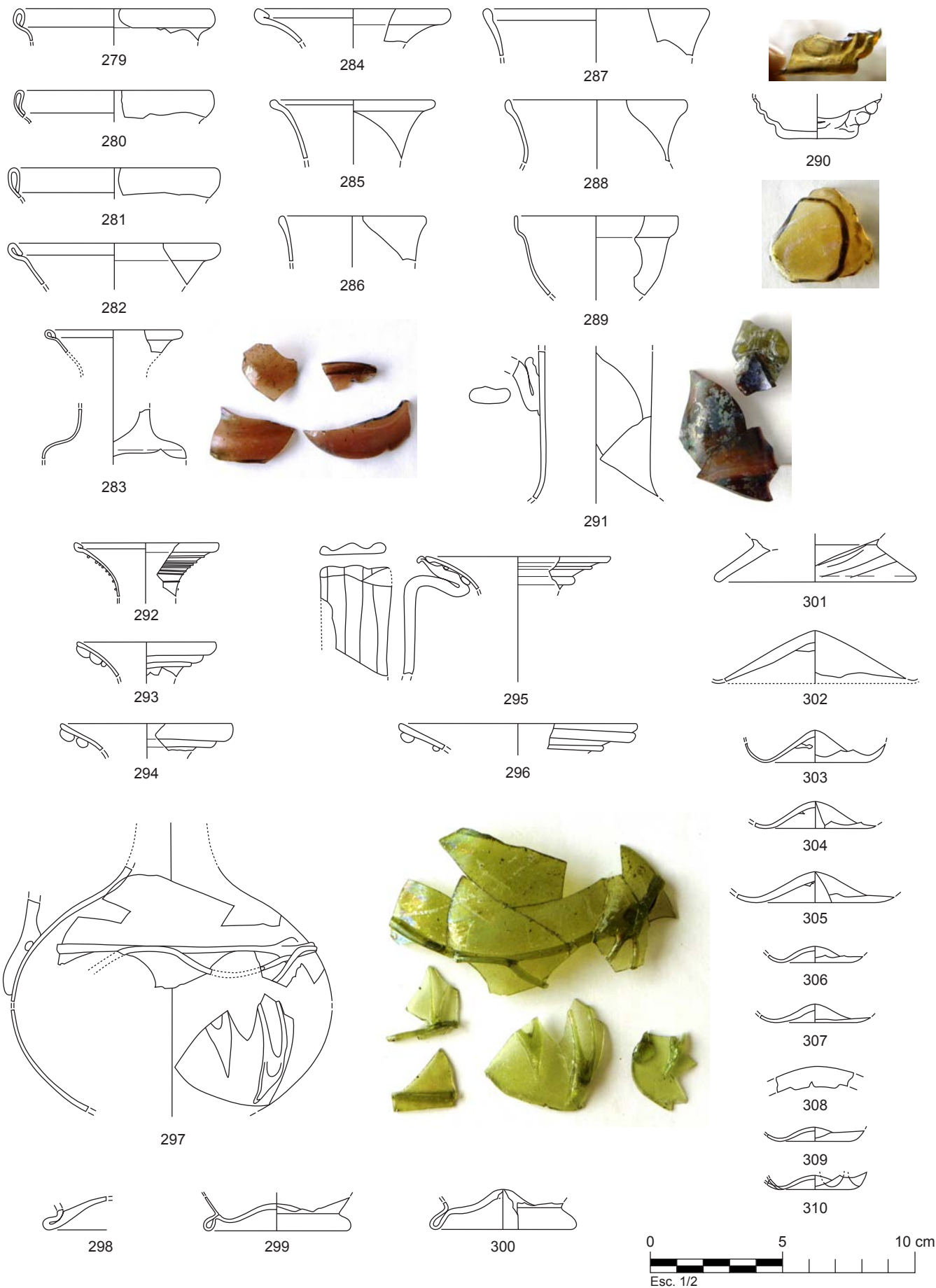

JARDÍ DEL CLAUSTRE DE LA CATEDRAL (Tarragona, Tarragonès), 1955  
 Nivells E i F  
 Cronologia: s. V

LÀMINA 327

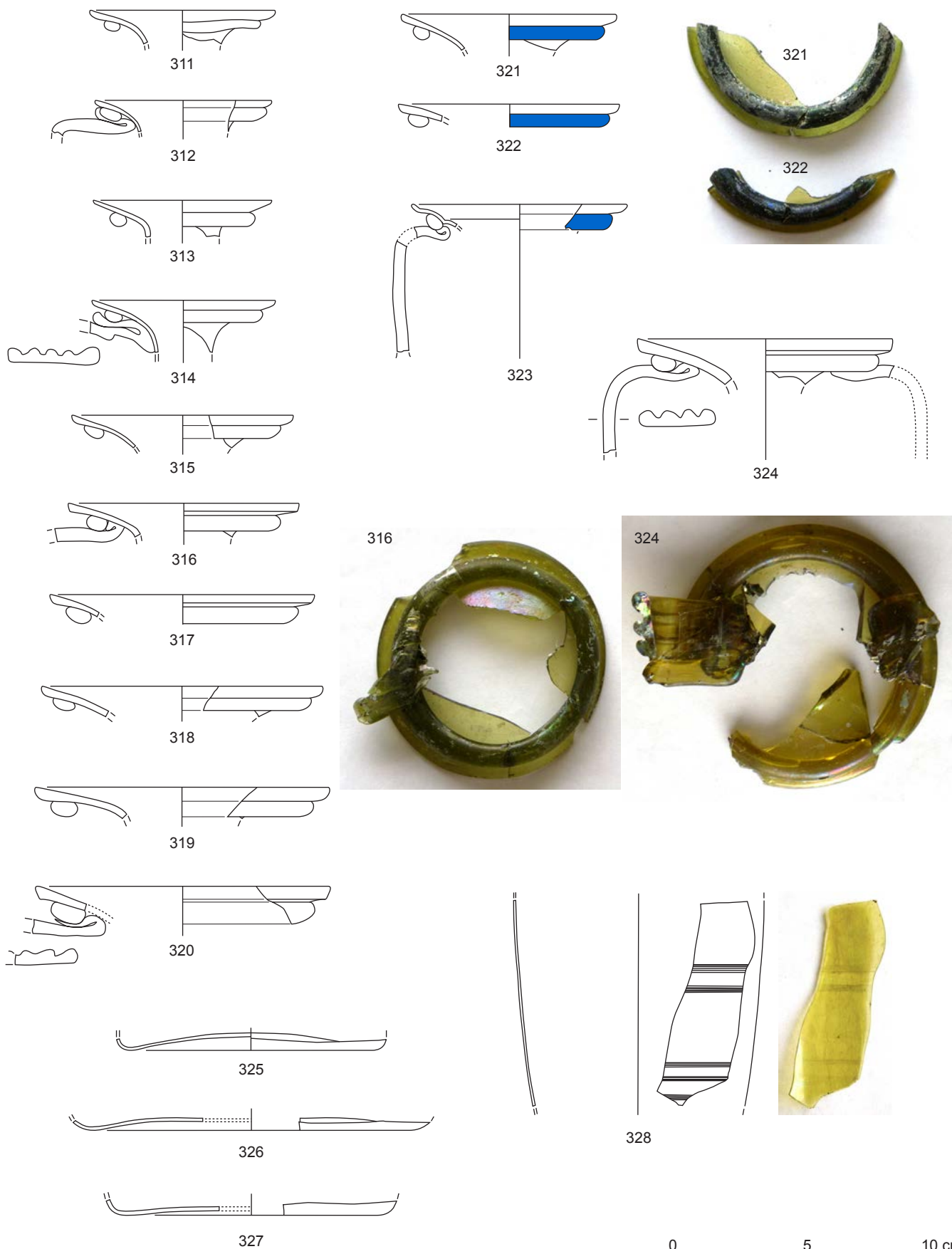

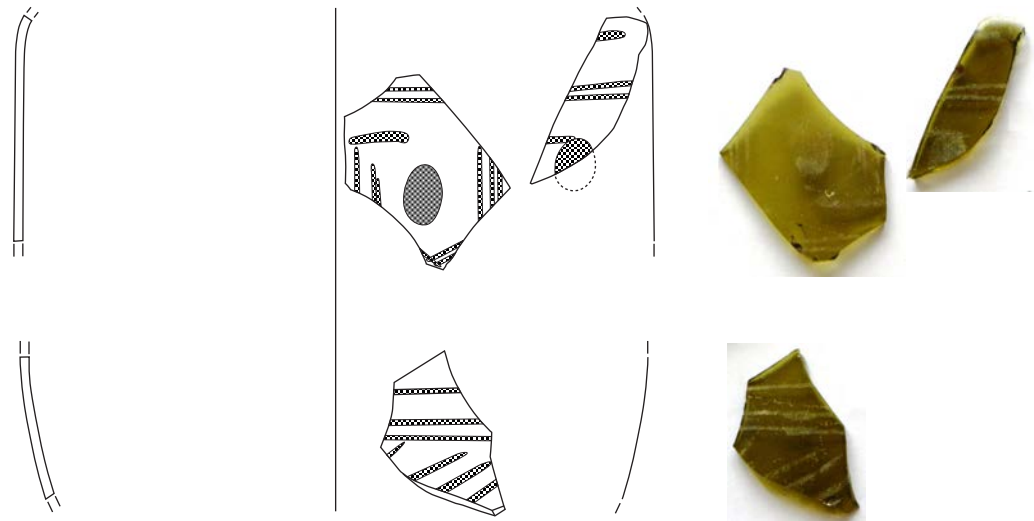

329

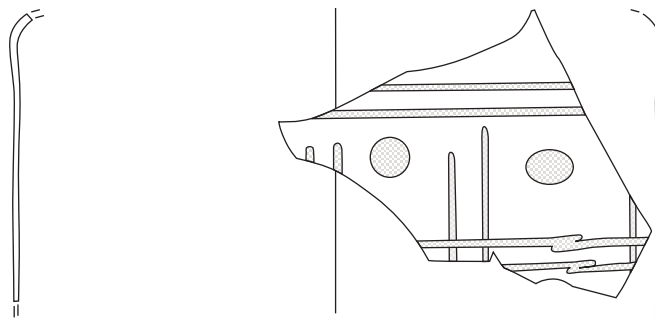

330

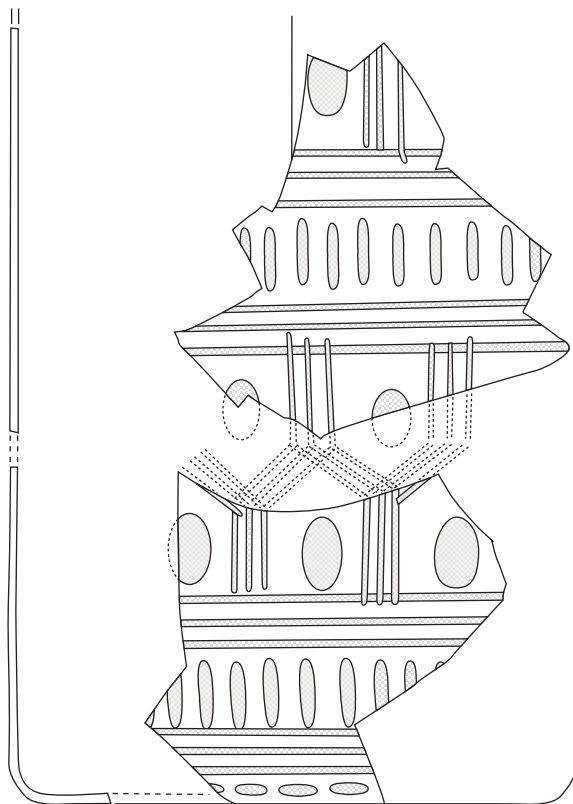
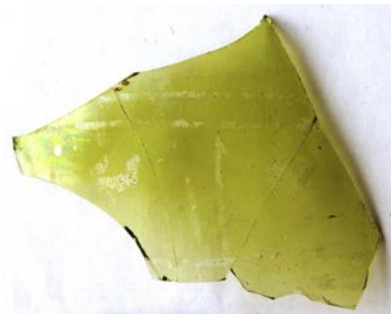

331

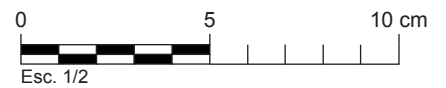

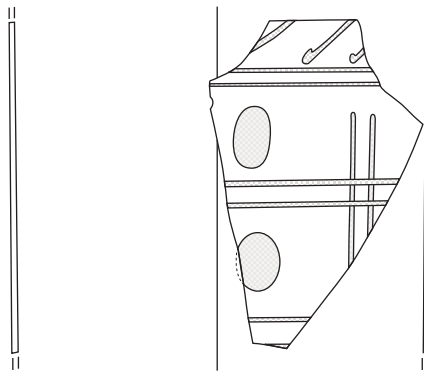

332

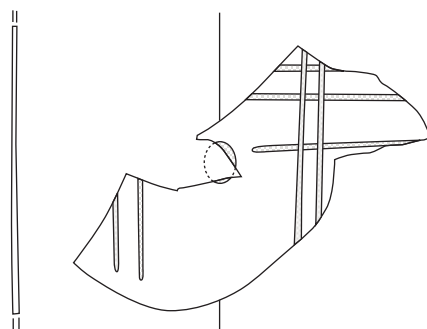

333

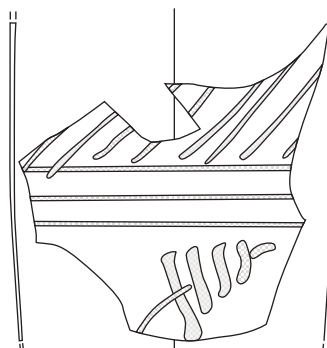

334



335

Nucli de vidre en brut

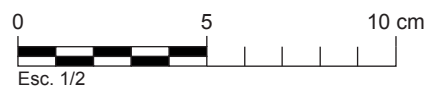

Vidre residual (s.I)

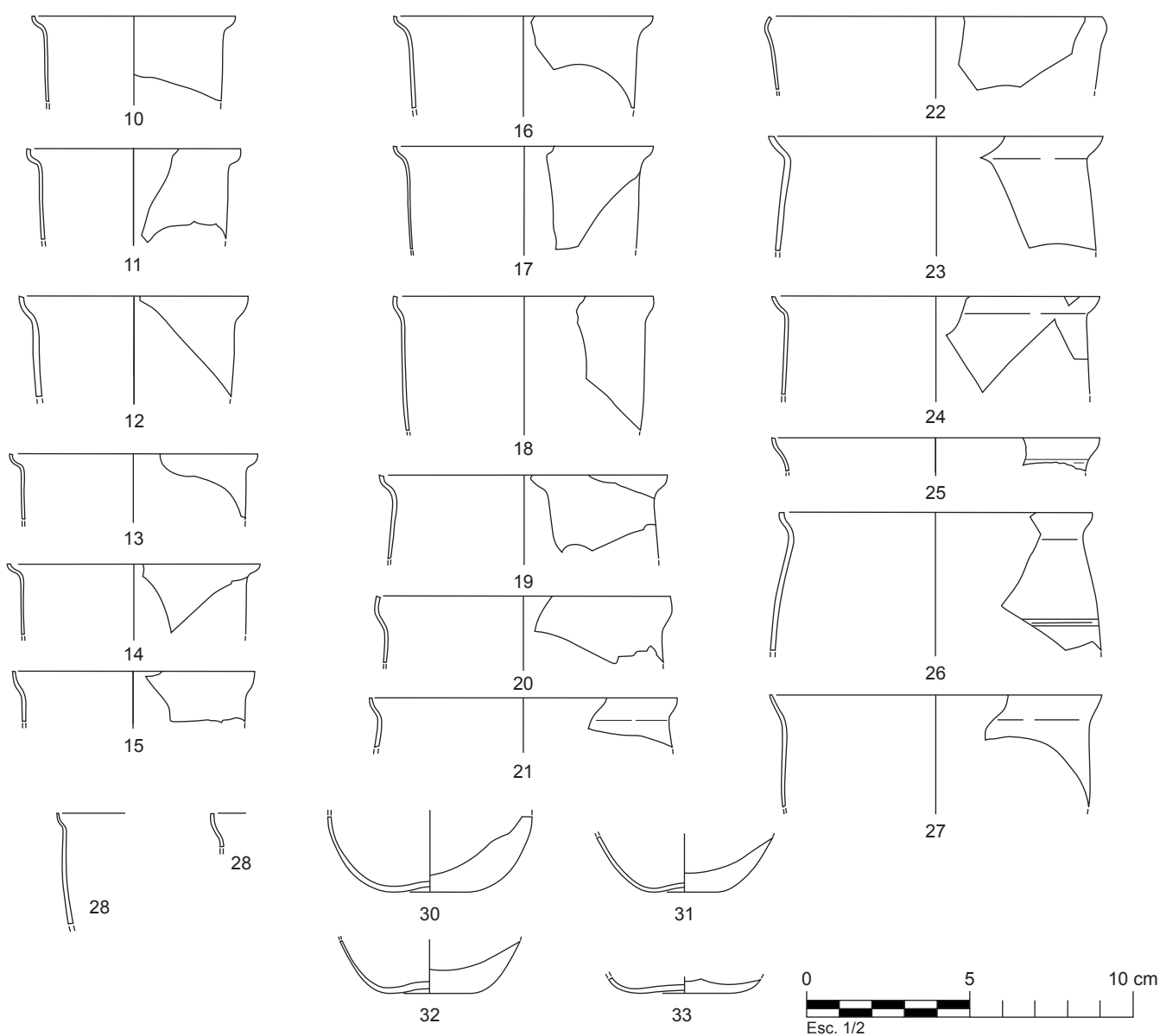
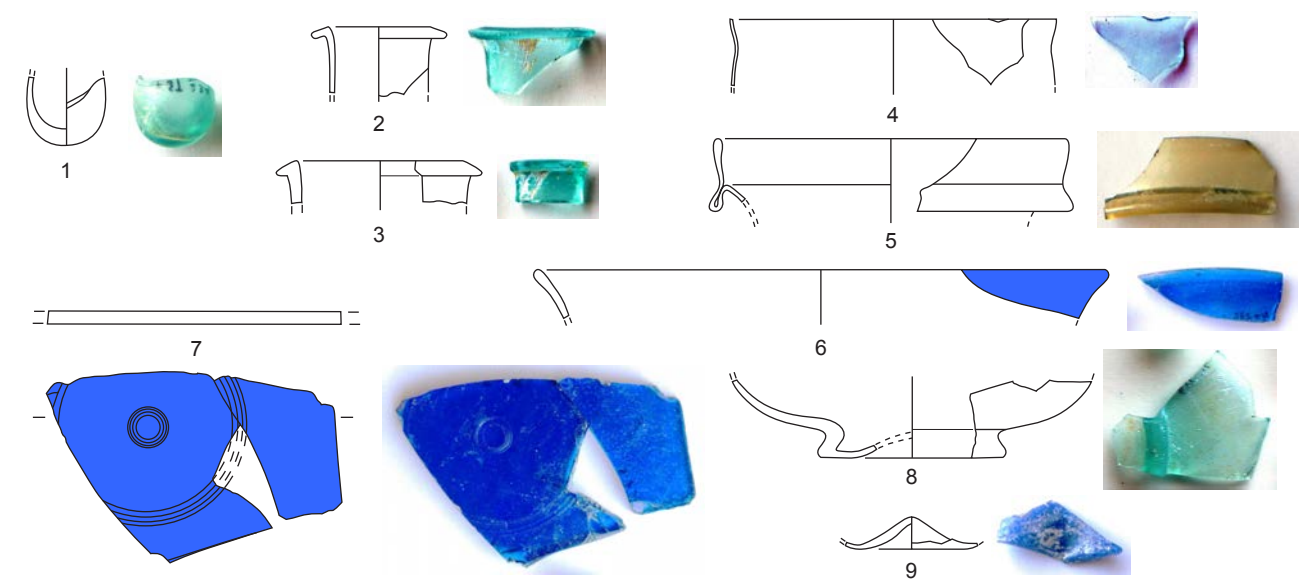

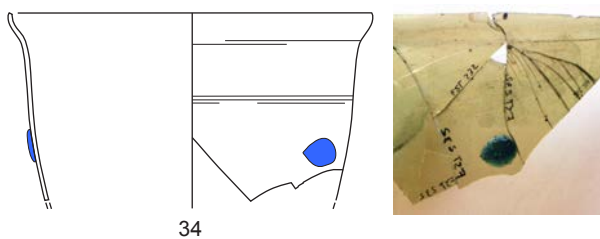

34

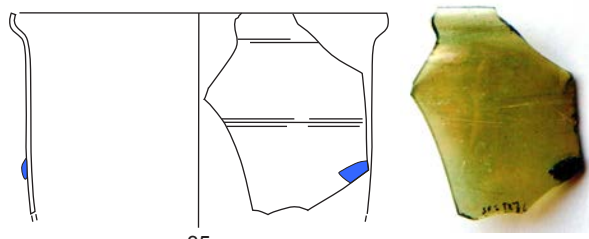

35

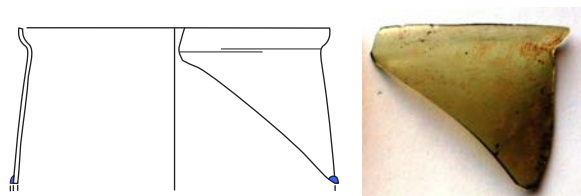

36

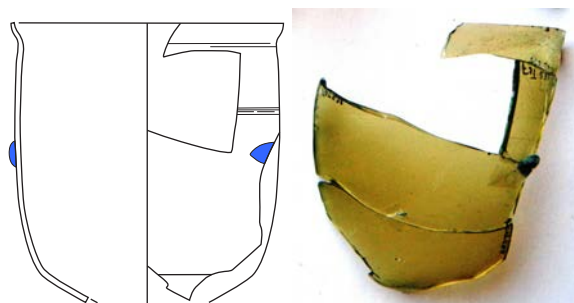

37



Fragments informes de gots amb gotes blaves



38

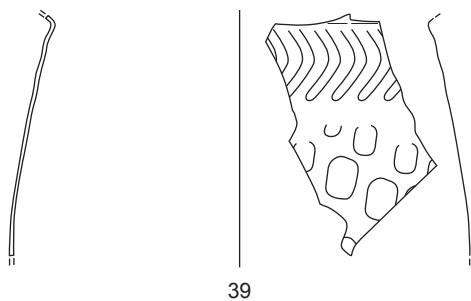

39

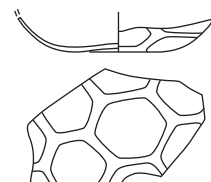

41

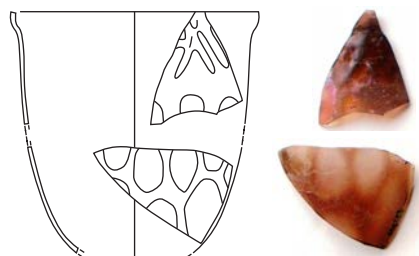

40



Got Is-107a com nº40  
Fotografia Artemis Gallery

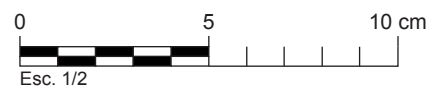



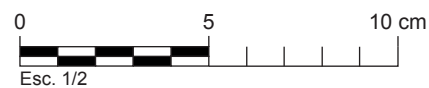
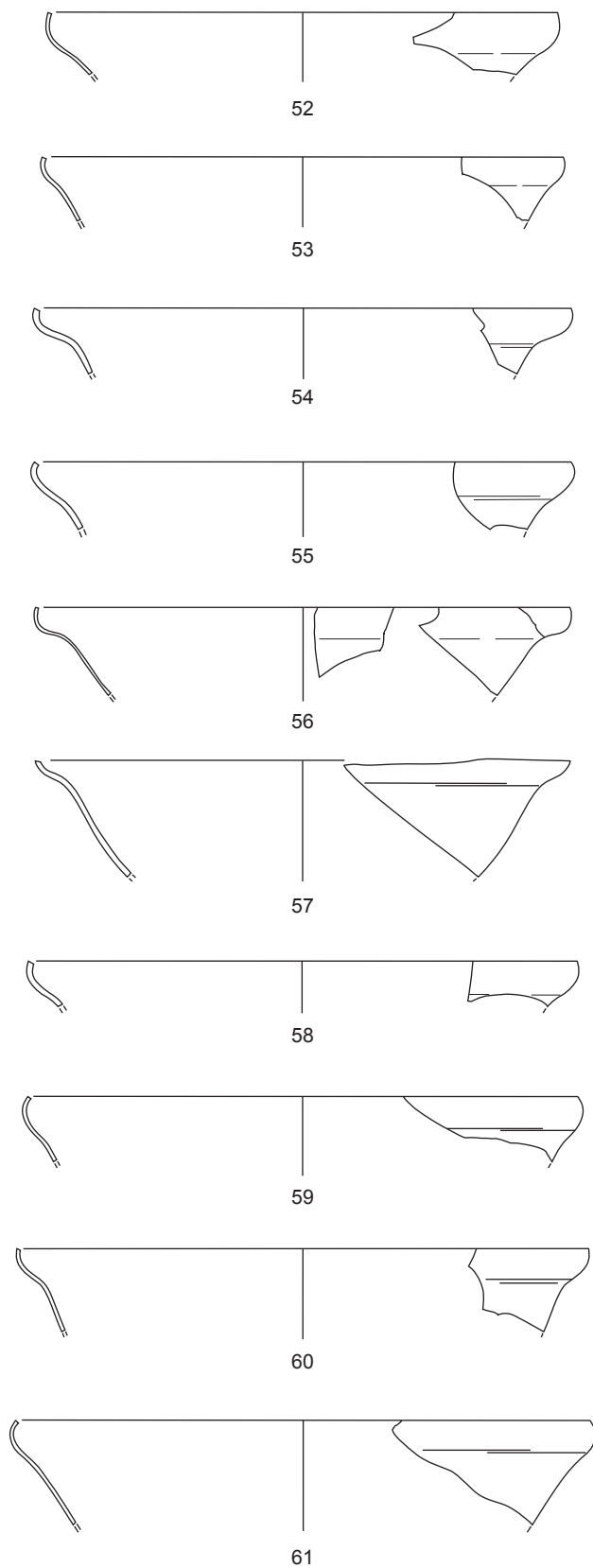
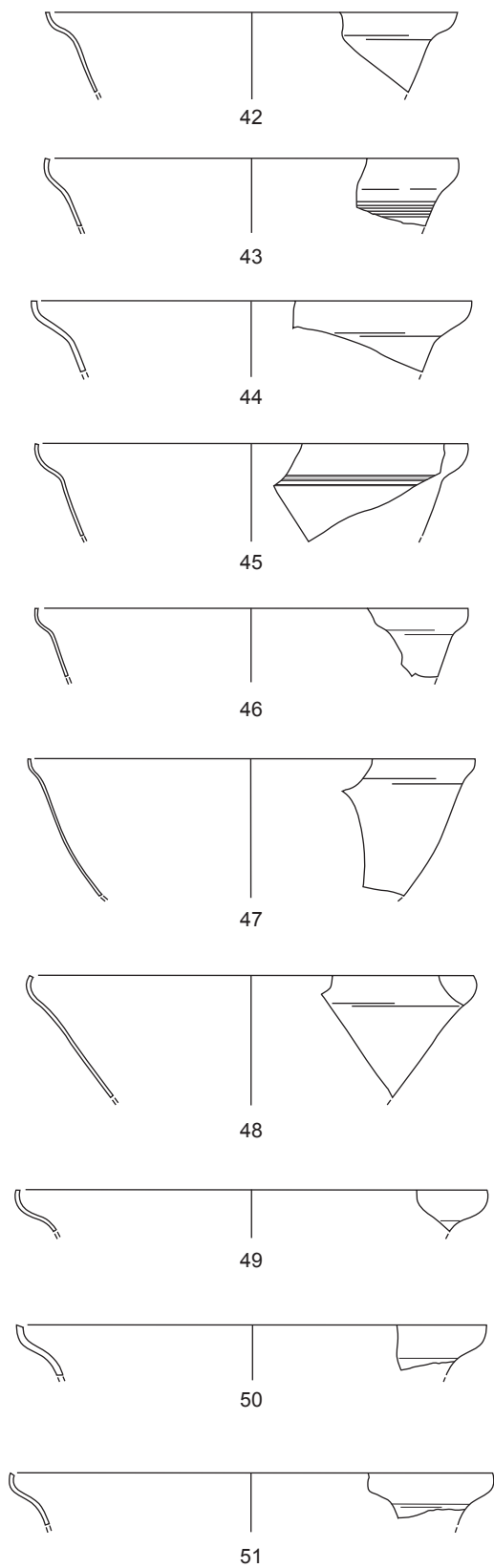

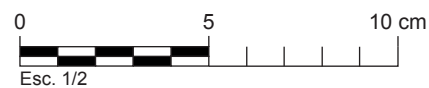
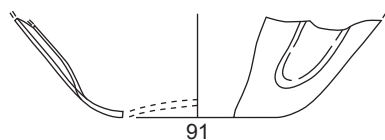
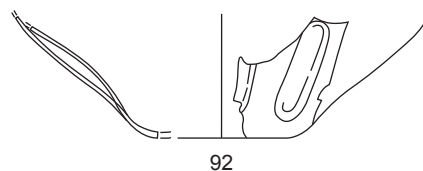
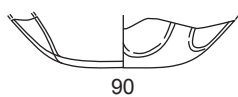
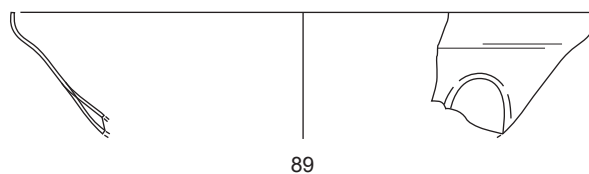
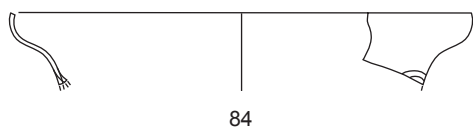
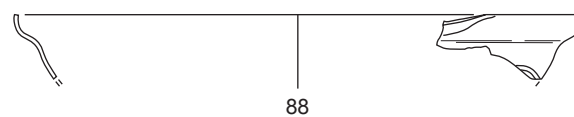
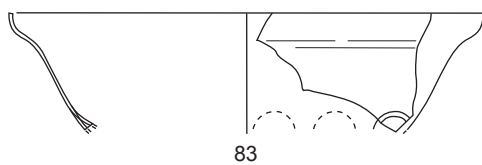
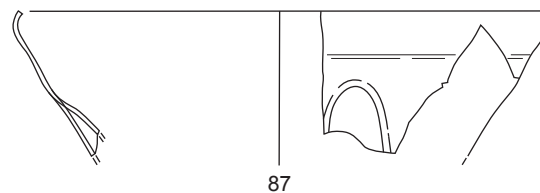
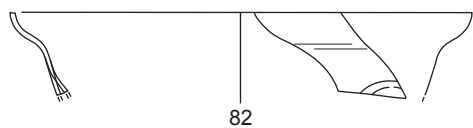
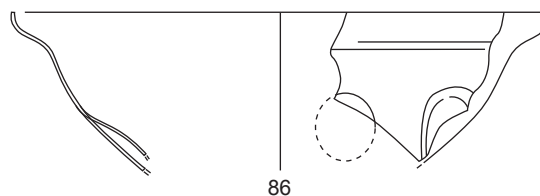
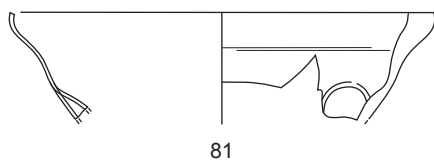
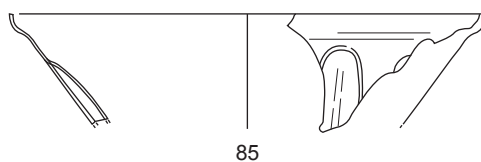
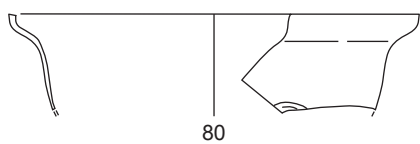
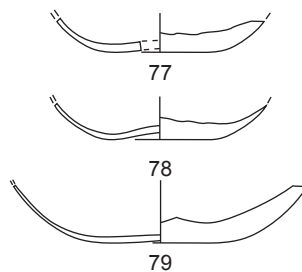
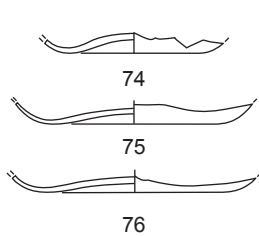
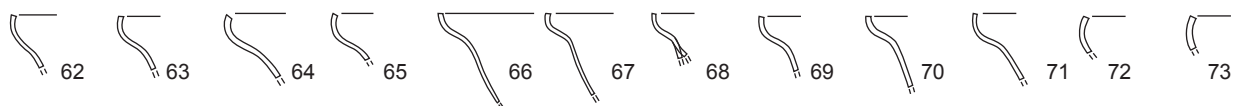

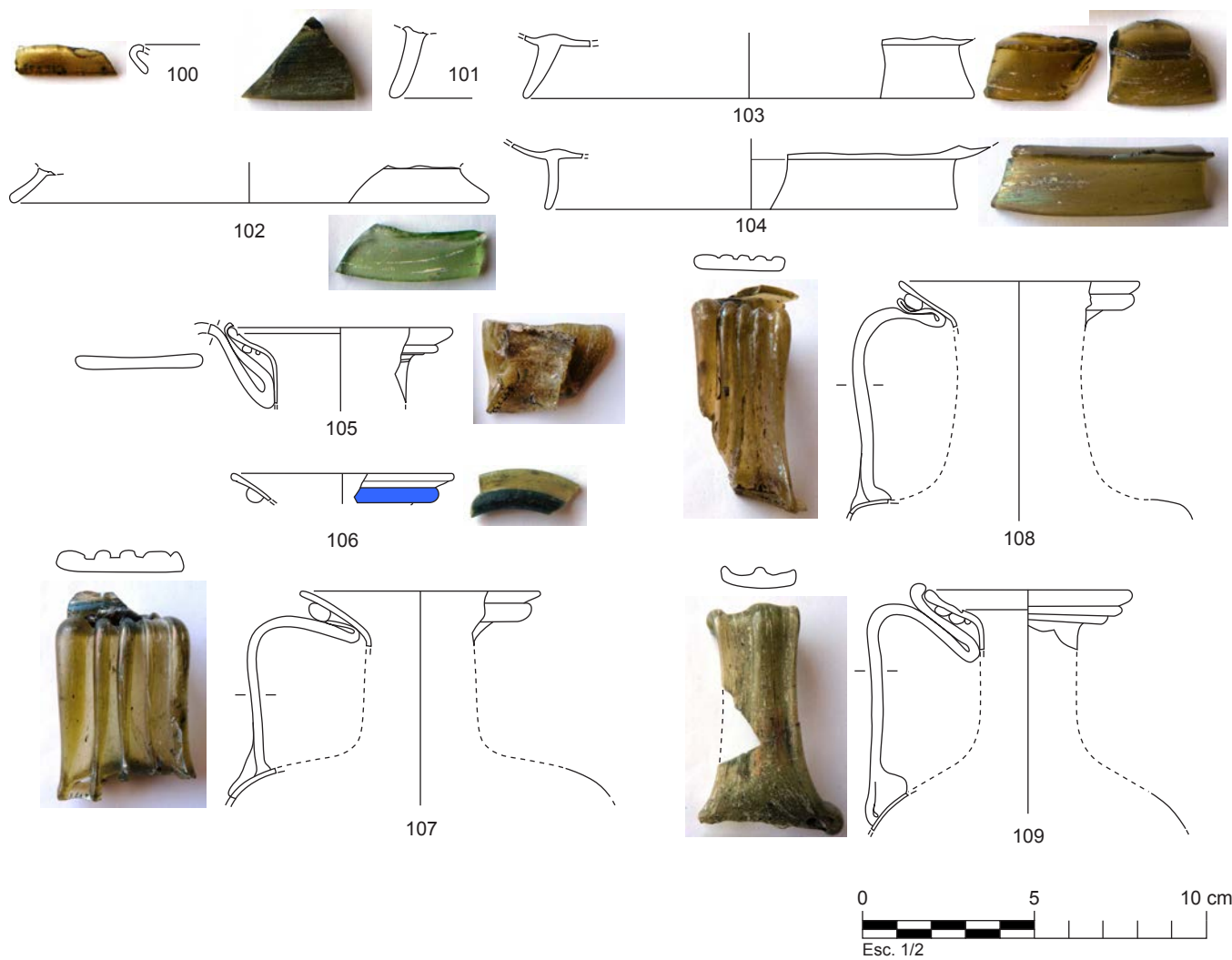
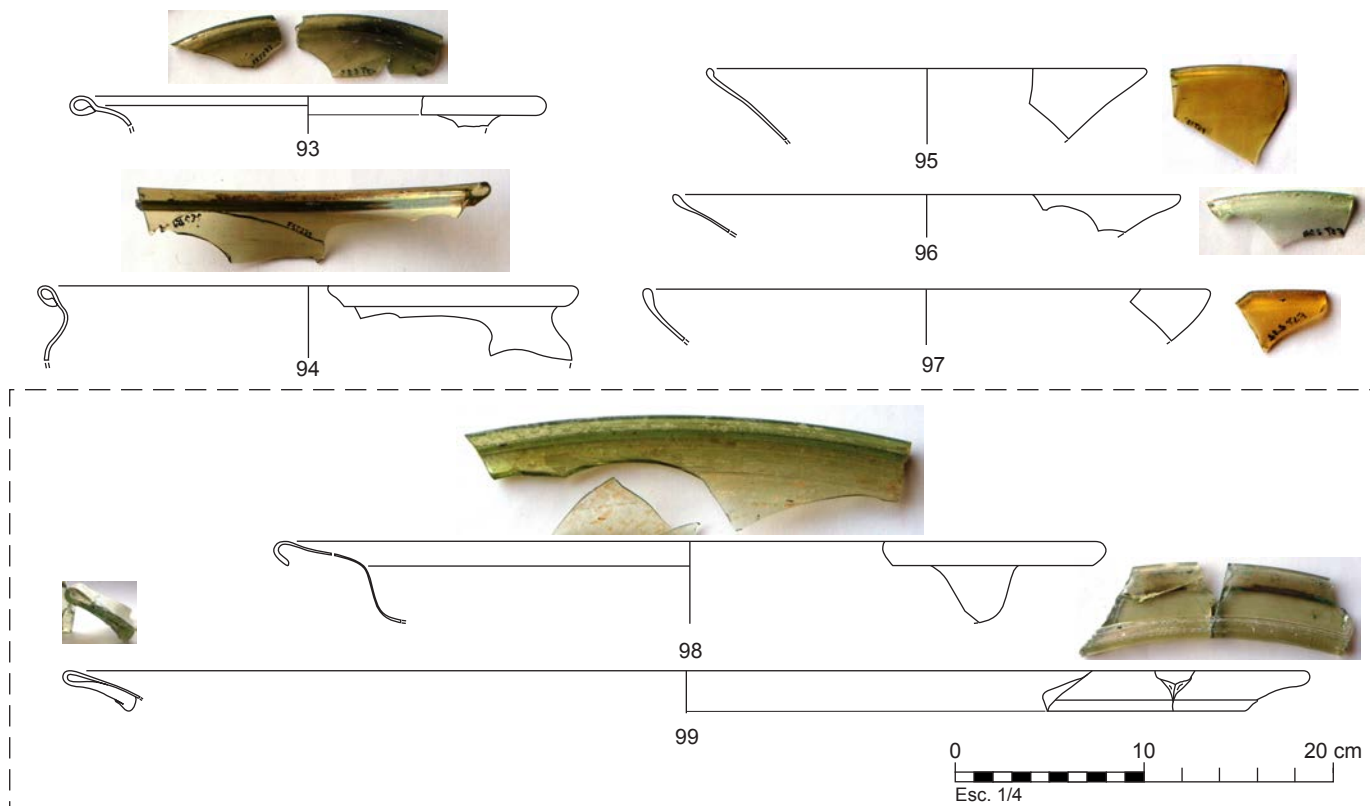

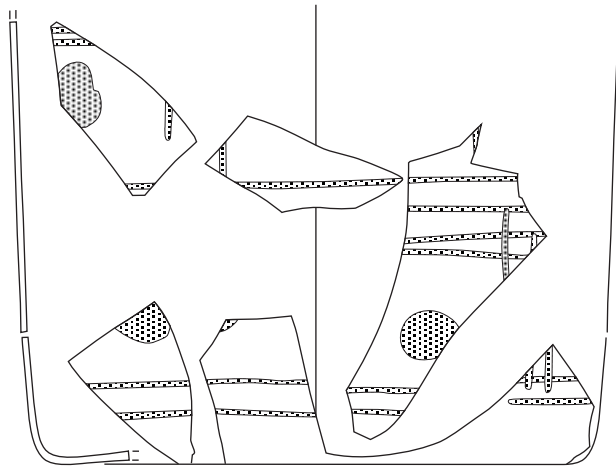

110

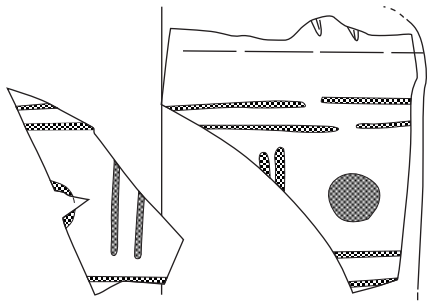

111

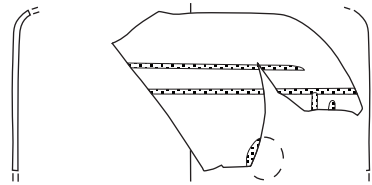

112

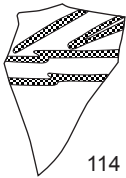

114



115

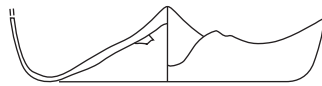

118

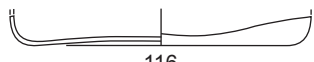

116



119

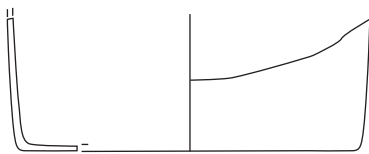

117



120



121

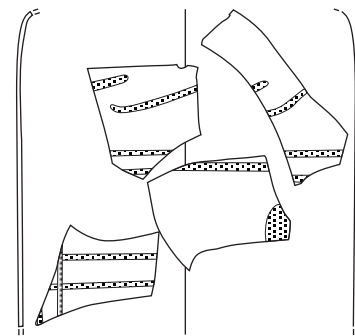

113

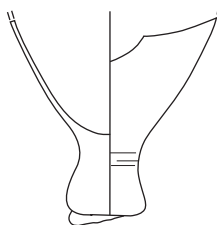

122

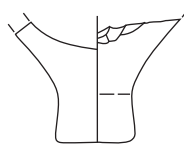

123

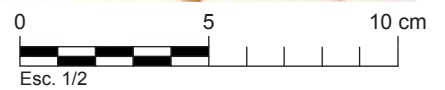

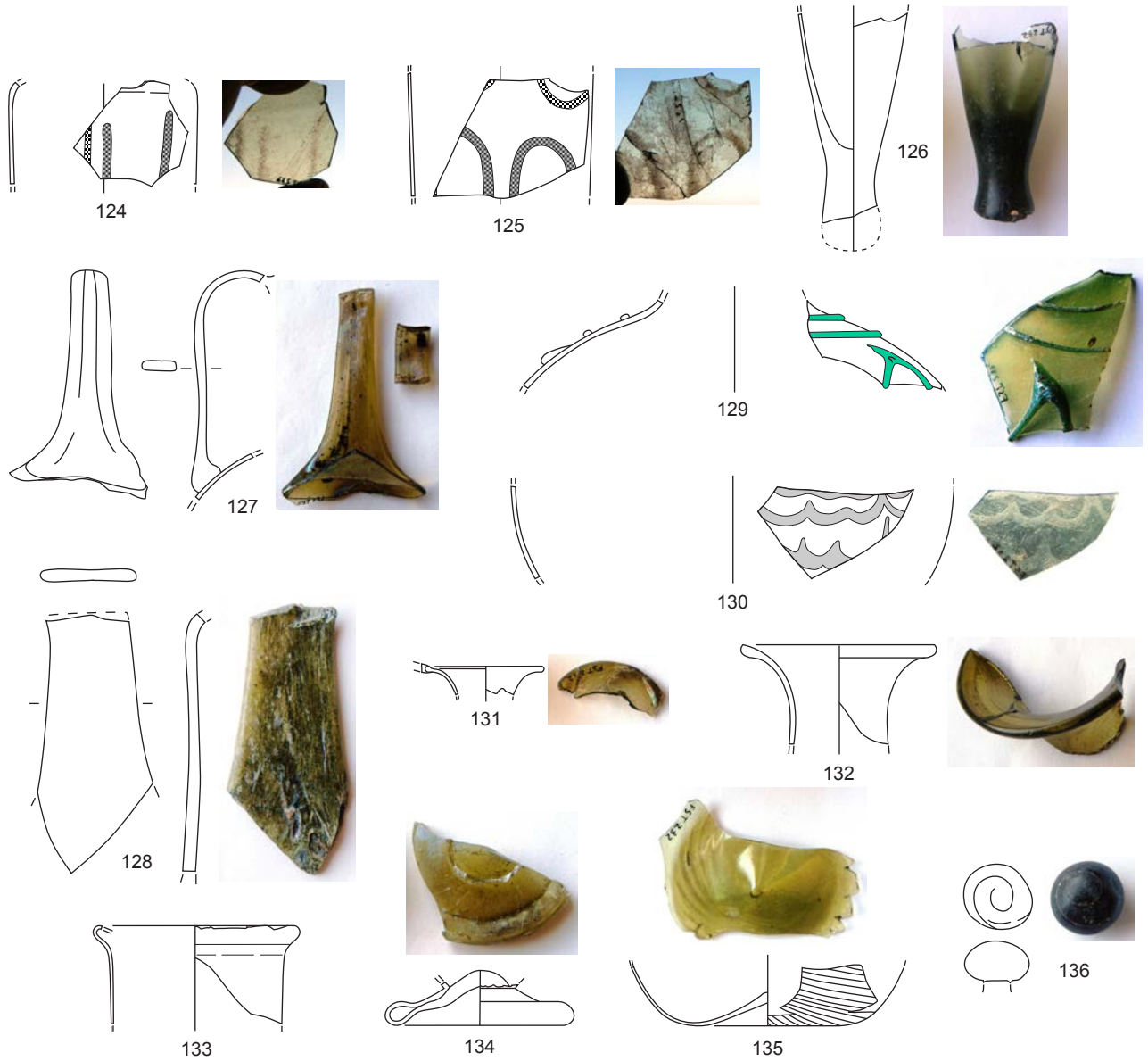

Rebuits de producció (moils)

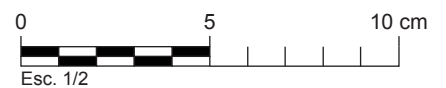
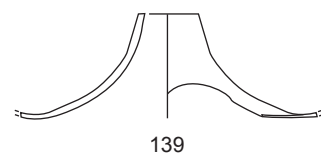
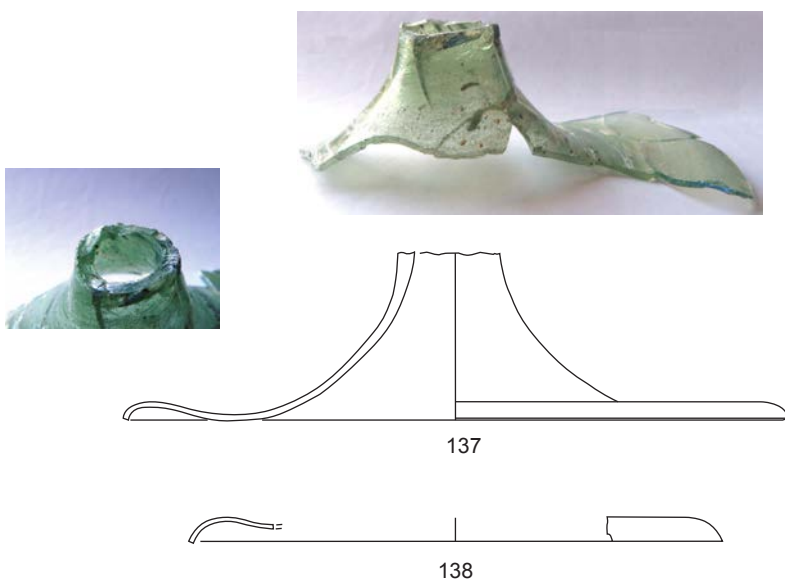

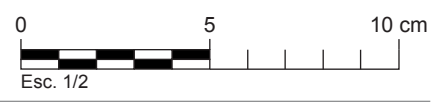
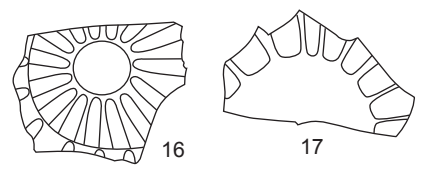
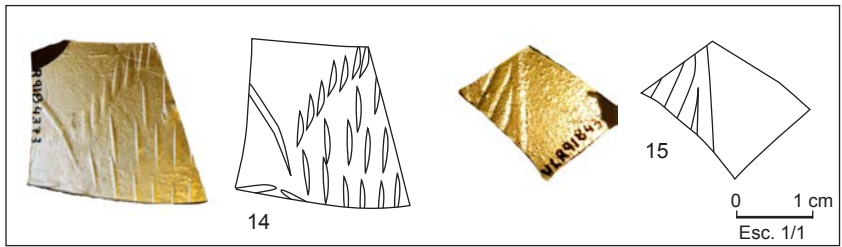
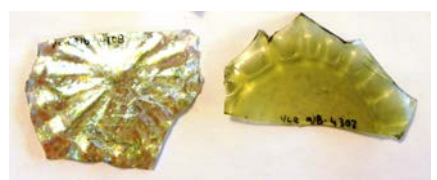
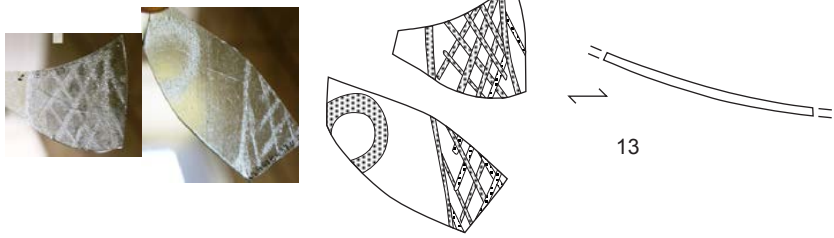
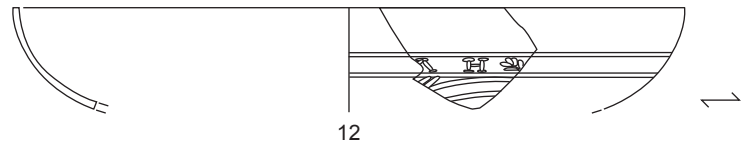
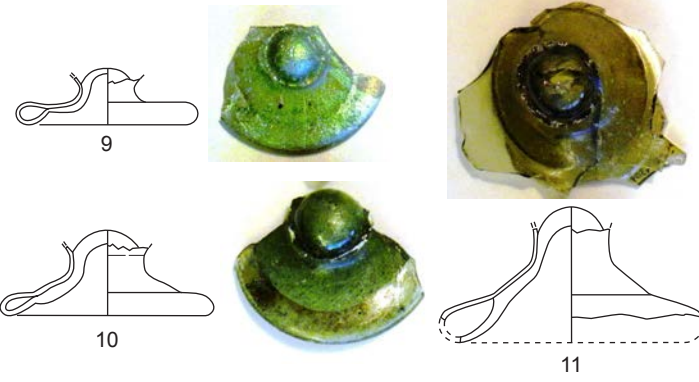
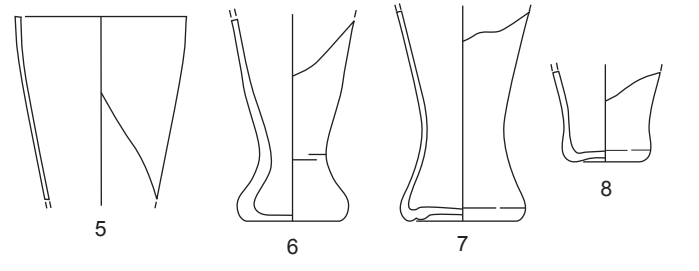
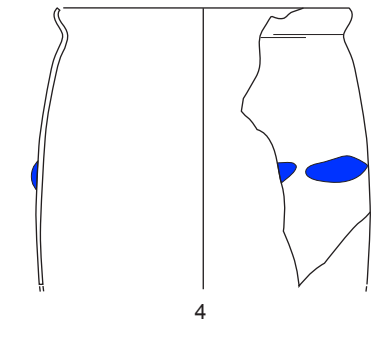
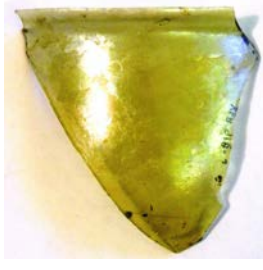
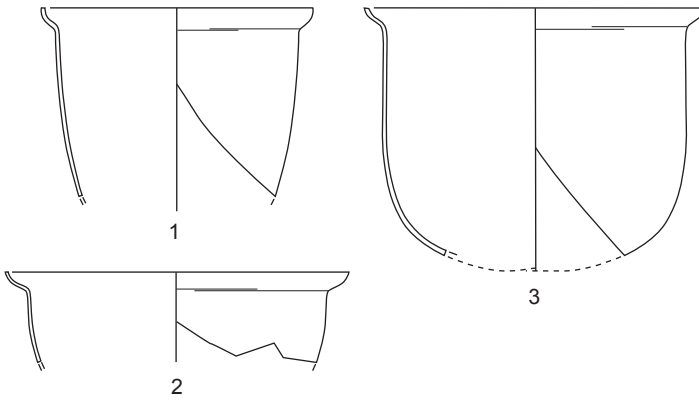

CARRER VILA-ROMA (Tarragona, Tarragonès), 1987  
 Ue. 918  
 Cronologia: s.V

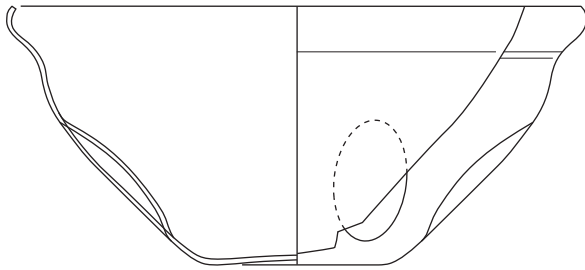

18

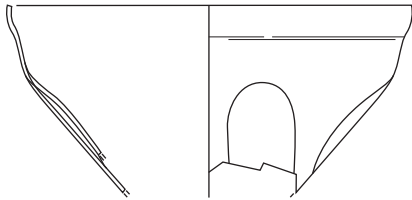
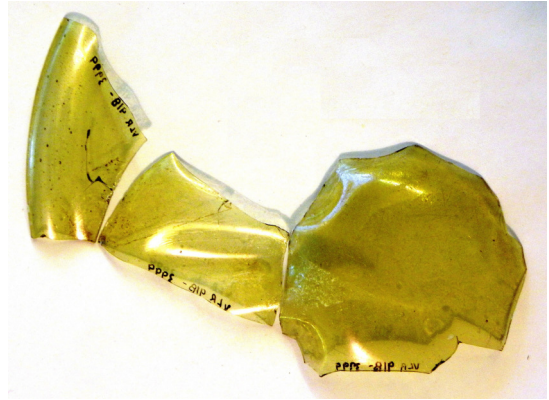

19

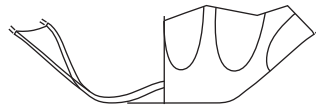

20



21



22

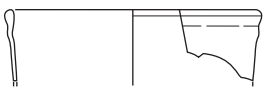

23

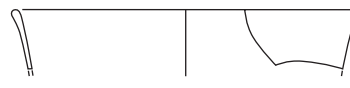

24



25



26

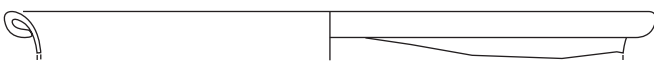

27



28



29



30

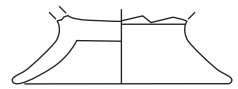

33



31

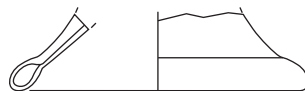

32

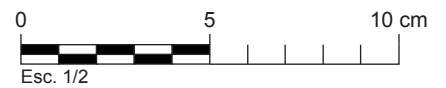

Esc. 1/2



34

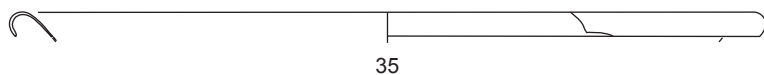

35

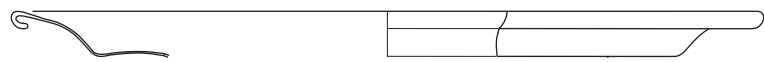

36



0 10 cm  
Esc. 1/4

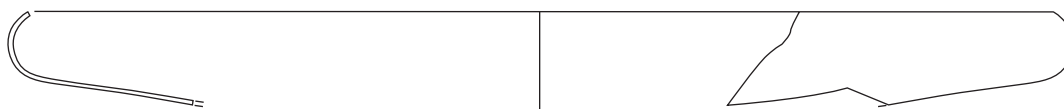

37

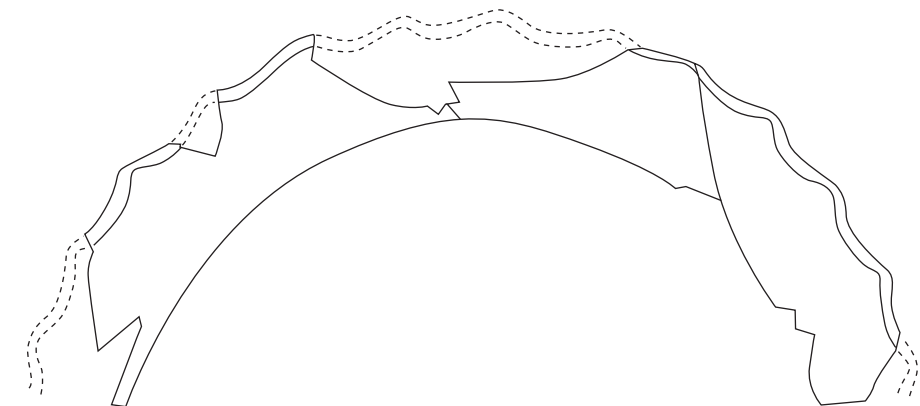

38



40

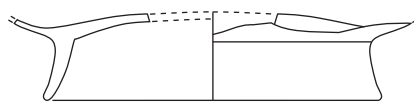

41

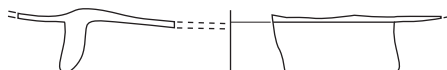

42

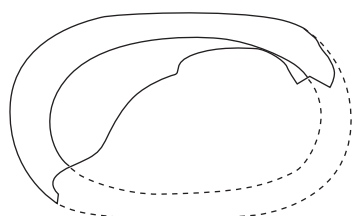

39

0 5 10 cm  
Esc. 1/2



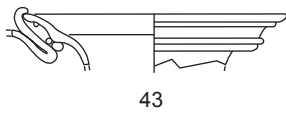

43

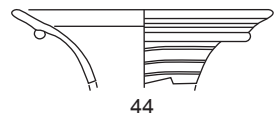

44

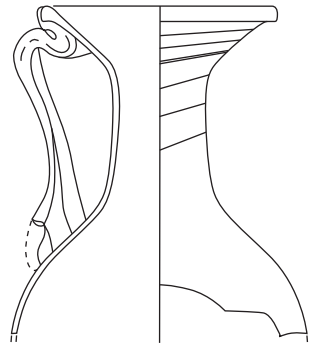

45

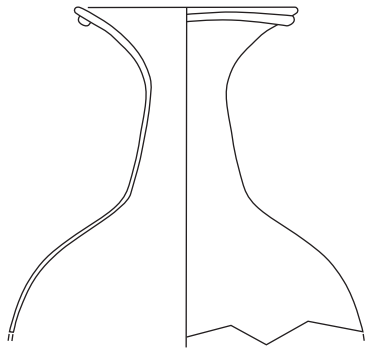

46

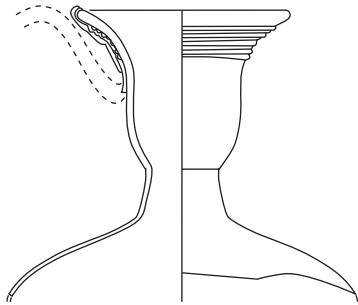

47

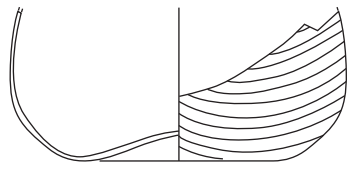

48

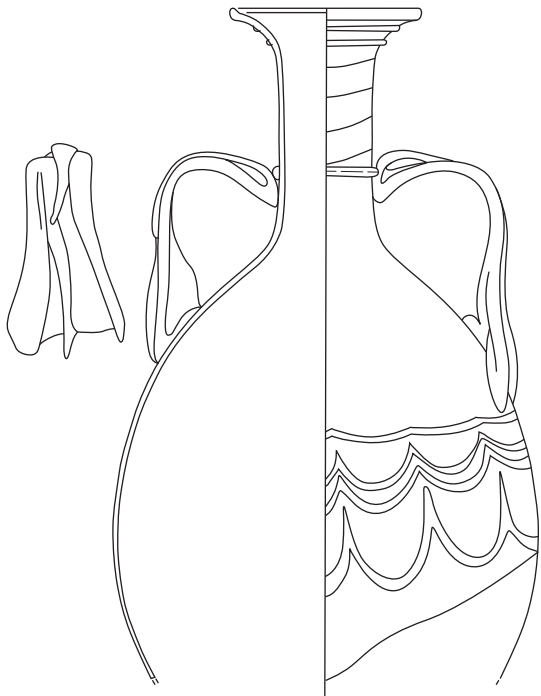

49



0 10 cm  
Esc. 1/4

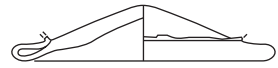
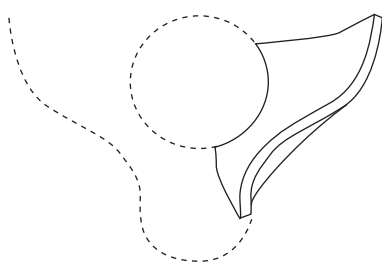

50

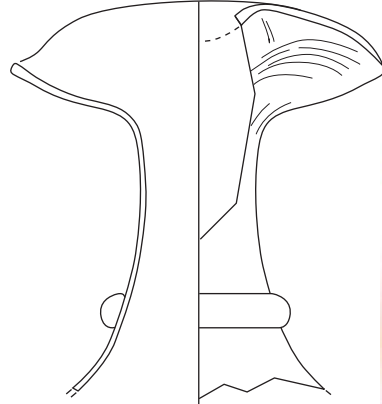

51



0 5 10 cm  
Esc. 1/2

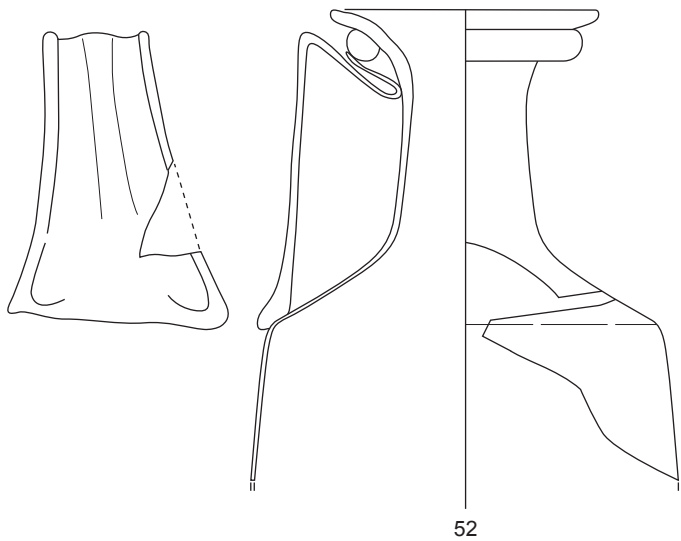

52

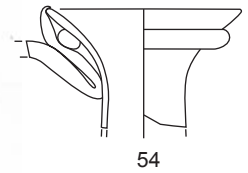

54

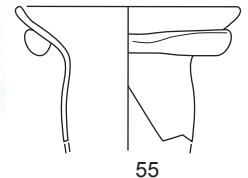

55

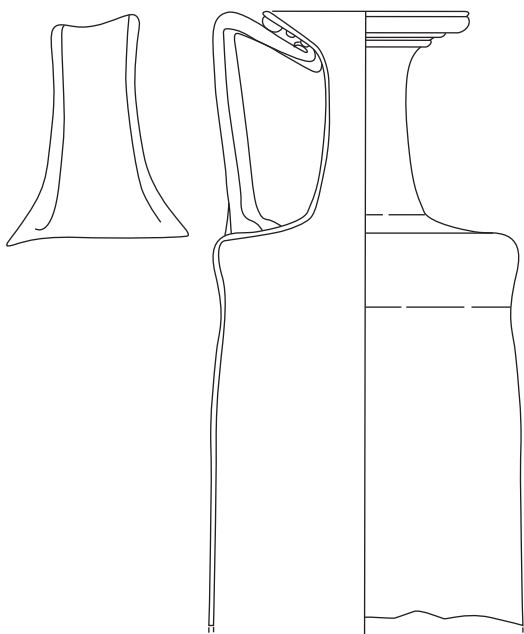

53

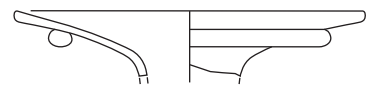

56

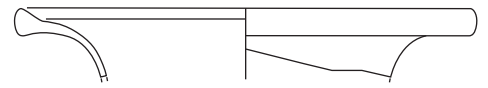

57



58

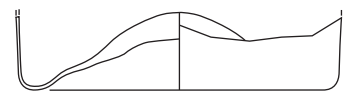

59



60

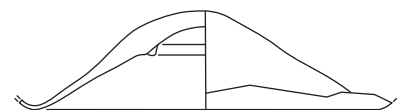

61

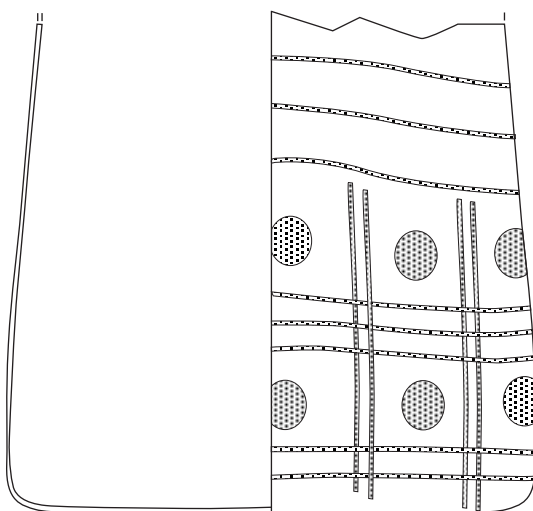

62

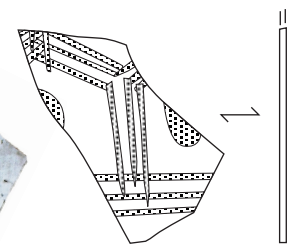
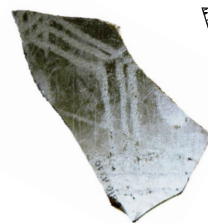

63

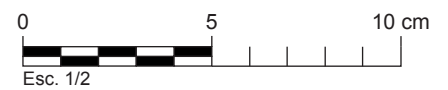

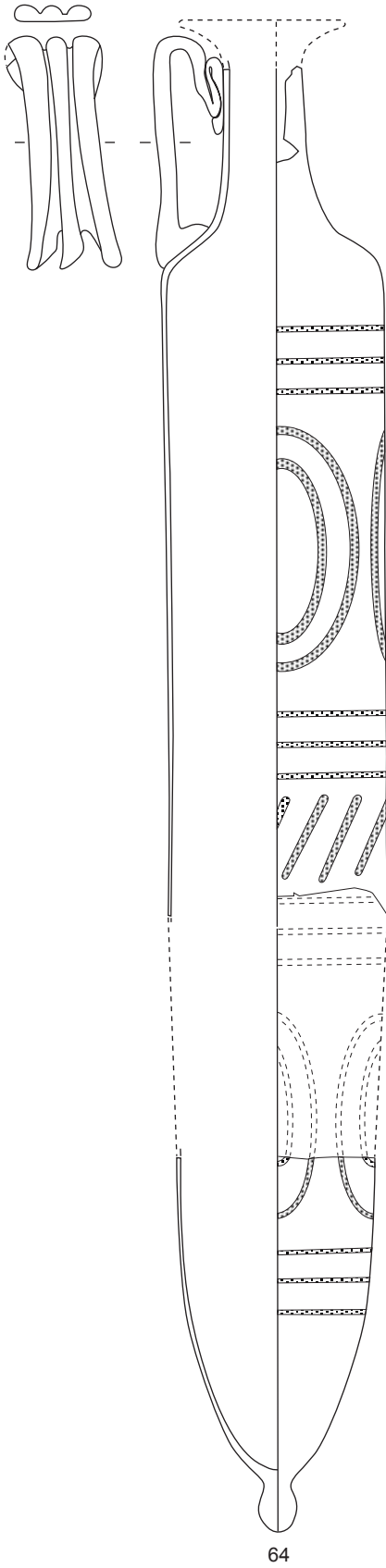

64

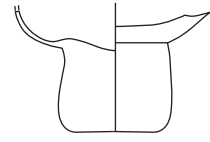

65

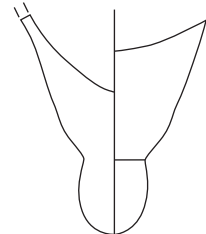

66



67

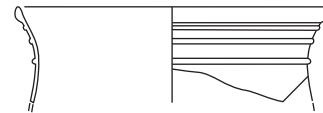

68

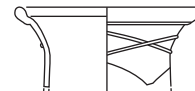

69

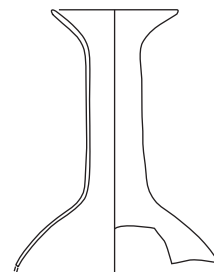

70

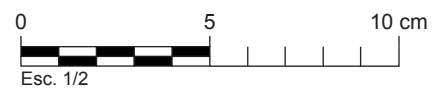

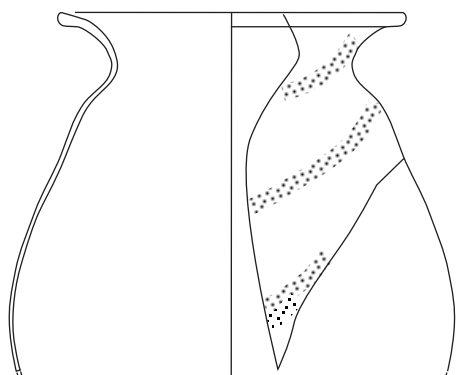

71

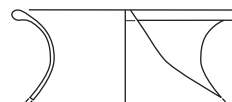

73

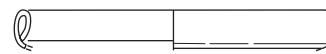
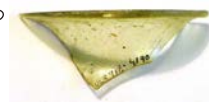

74



75

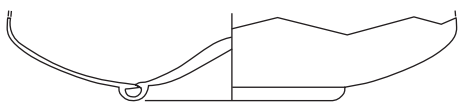

72

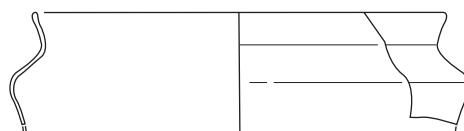

76

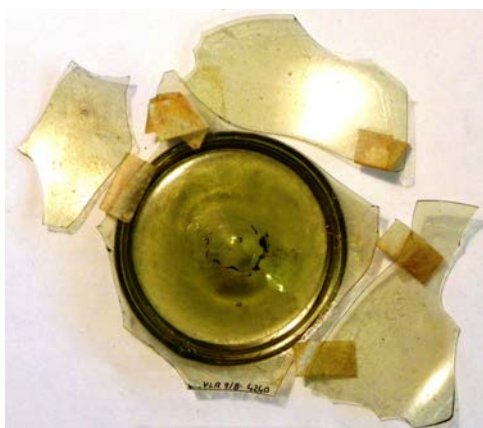

77

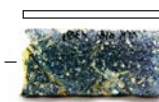

79



78

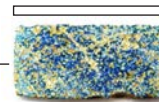

80



81

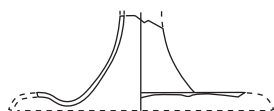

82

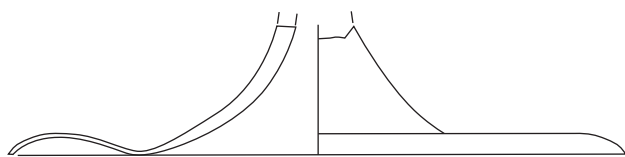

83

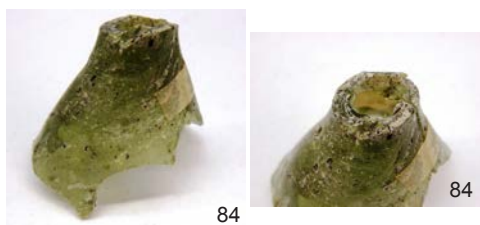

84

84

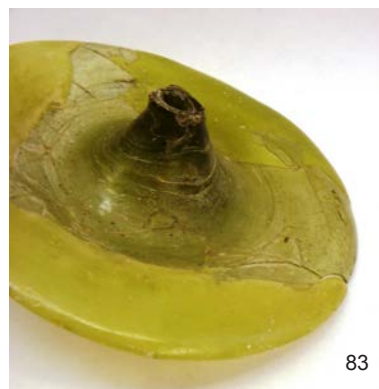

83

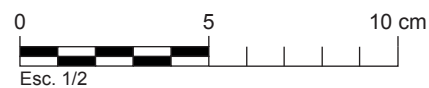

0

5

10 cm

Esc. 1/2

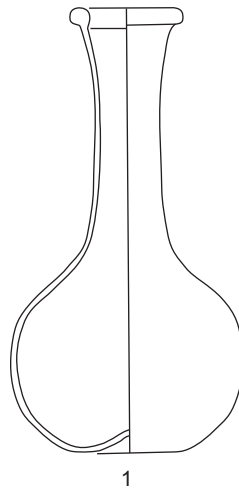

AAR-1217

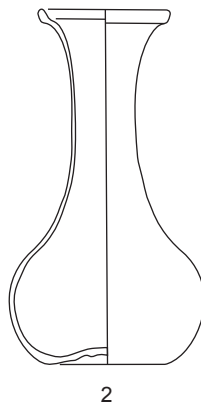

AAR-1226

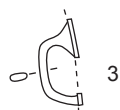

AAR-1213

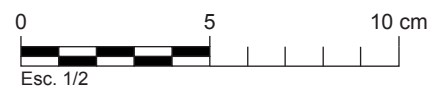
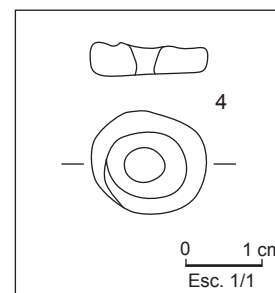

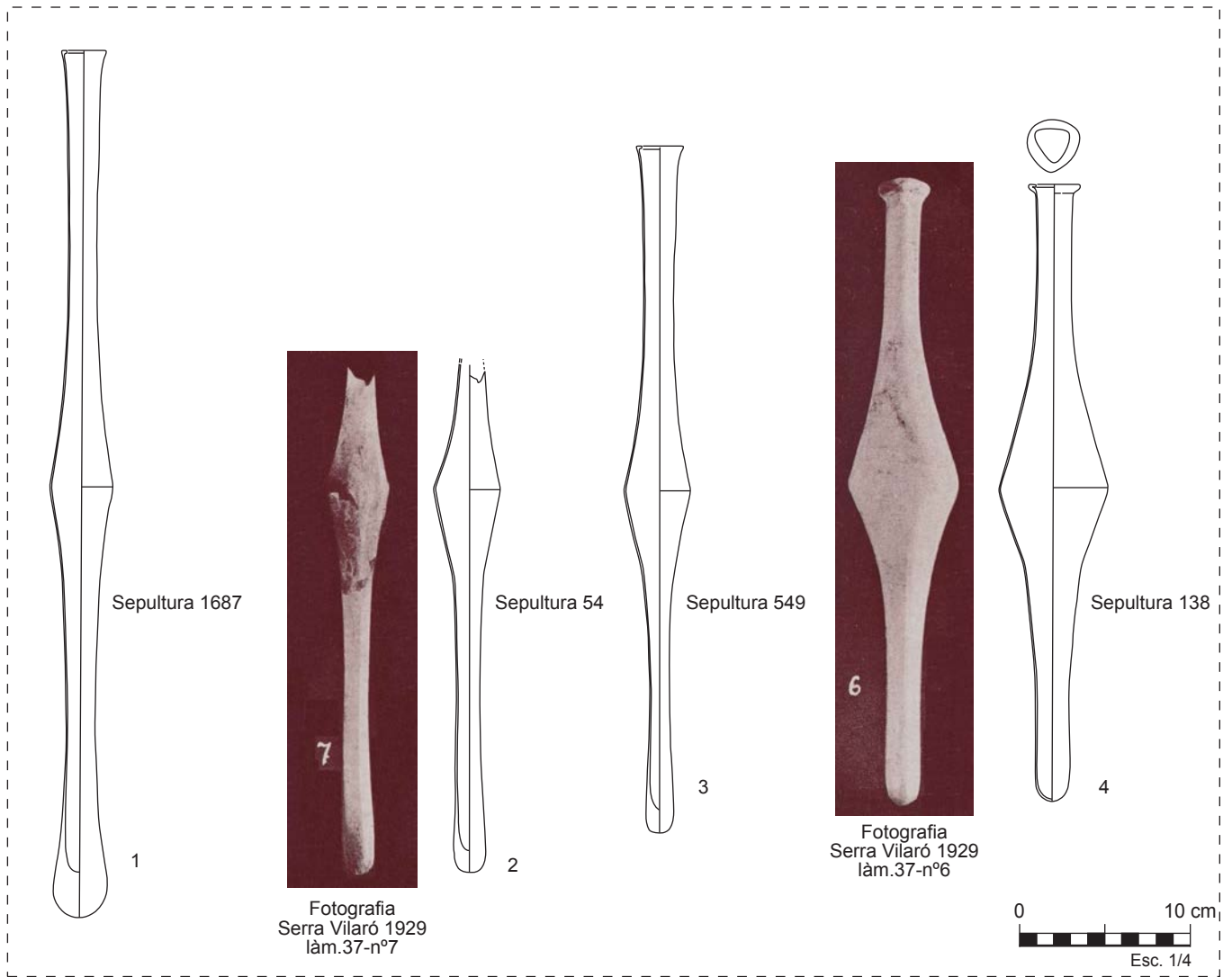

Sepultura 1687



Sepultura 549

Fotografies Serra Vilaró 1944, làm.27c i 27d

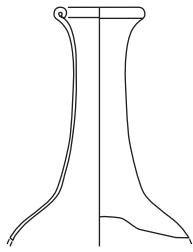

5

Sepultura 52

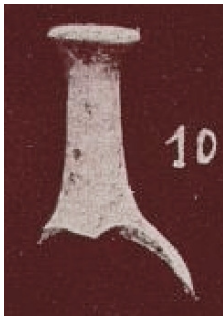

Fotografia  
Serra Vilaró 1929  
lám.37-nº10



Sepultura 830

Fotografia  
Serra Vilaró 1944  
lám.27a



6

Sepultura 830

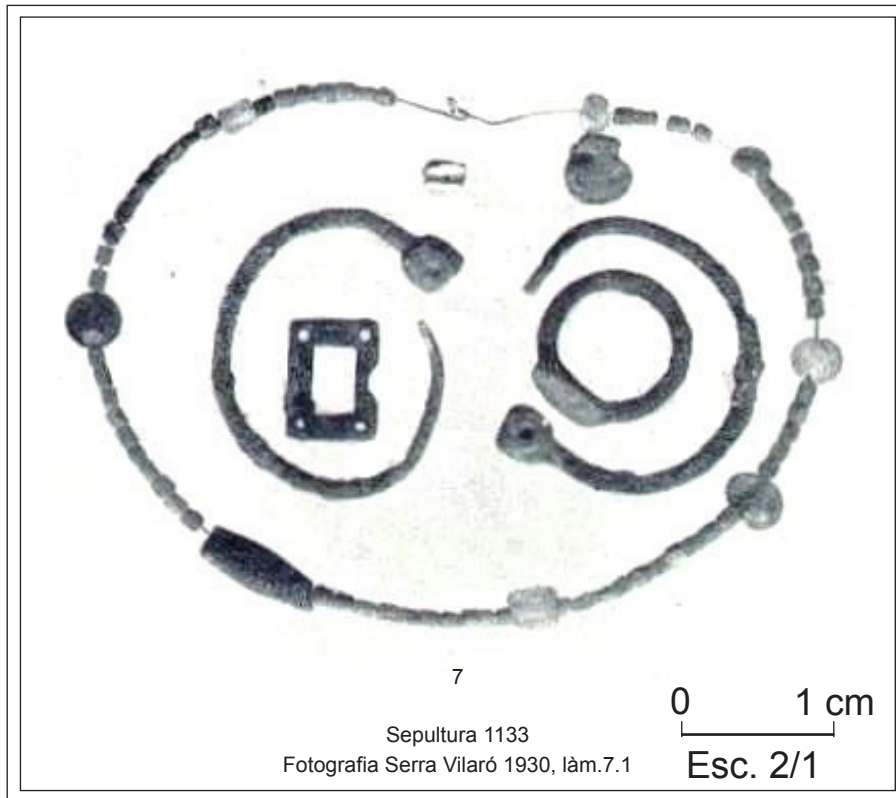
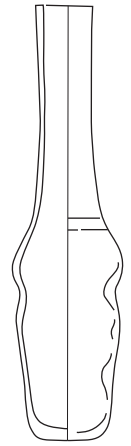
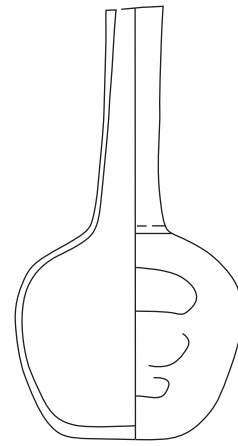

7

Sepultura 1133

Fotografia Serra Vilaró 1930, lám.7.1

0 1 cm

Esc. 2/1

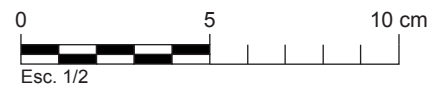

Esc. 1/2



Sepultura 1154

8



Sepultura 1236

9

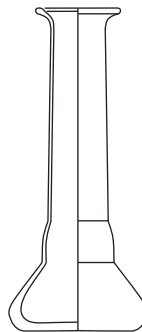

10

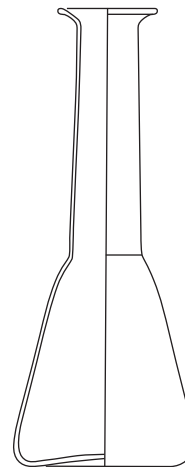

11

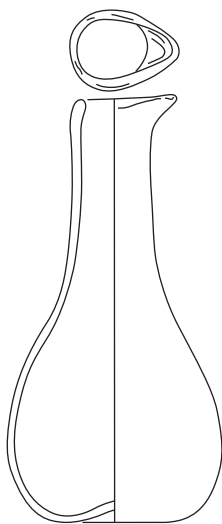

12

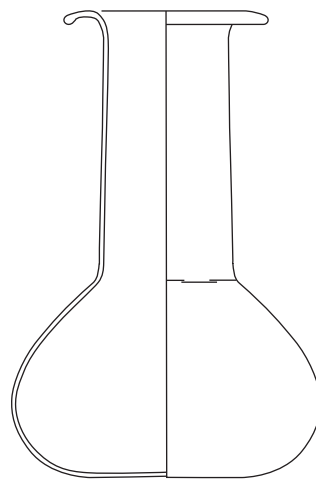

13

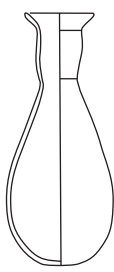

14

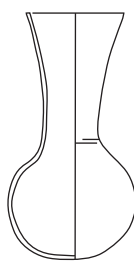

15

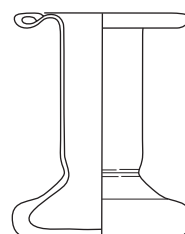

16

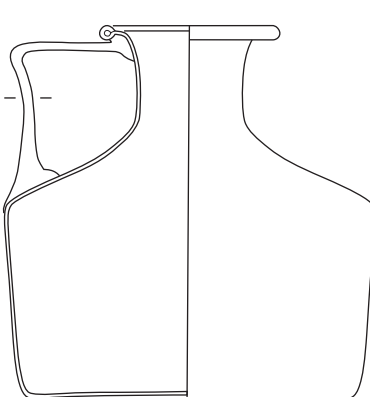
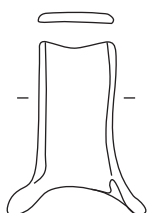

17

Tomba amb volta

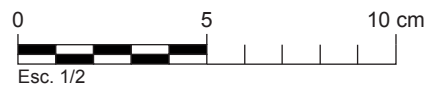

Esc. 1/2



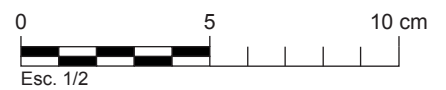
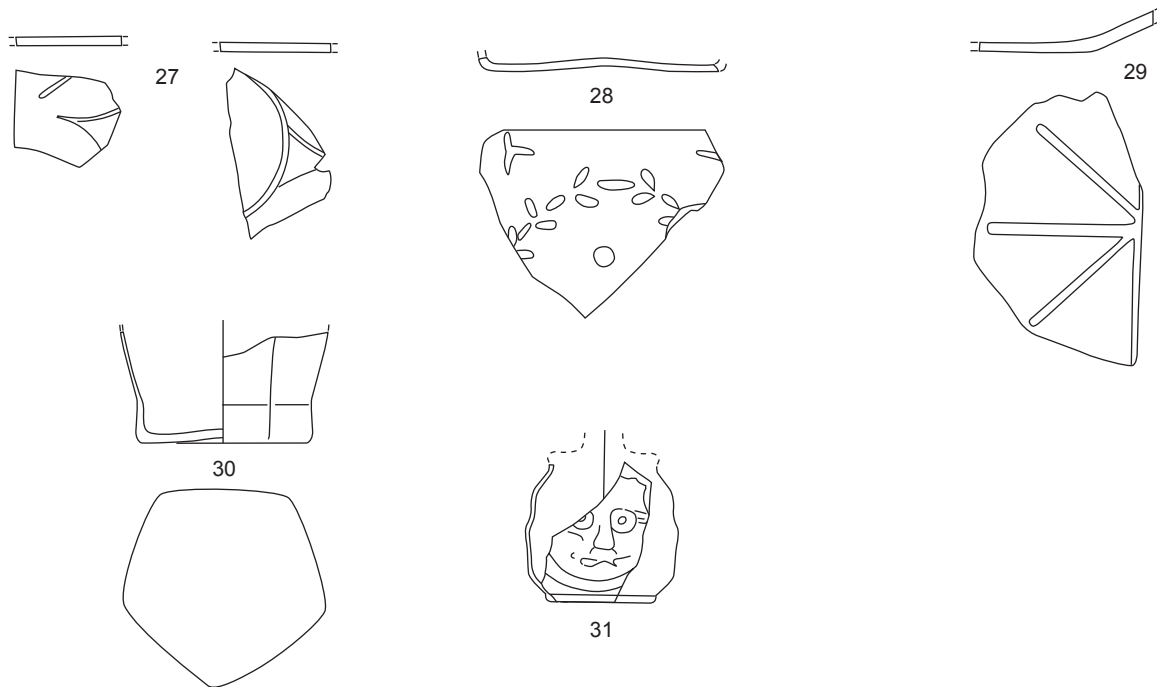
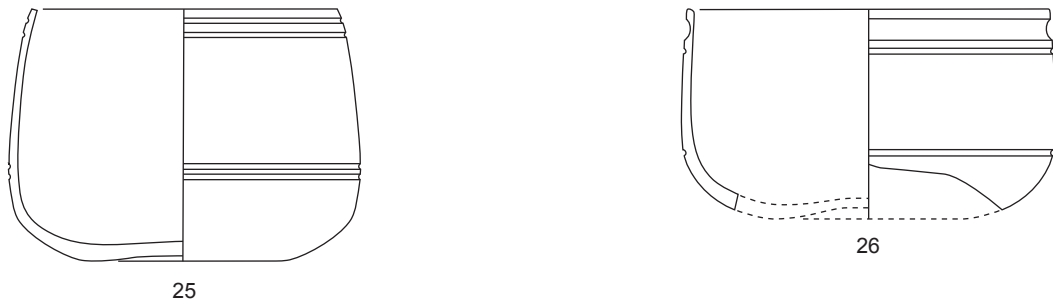
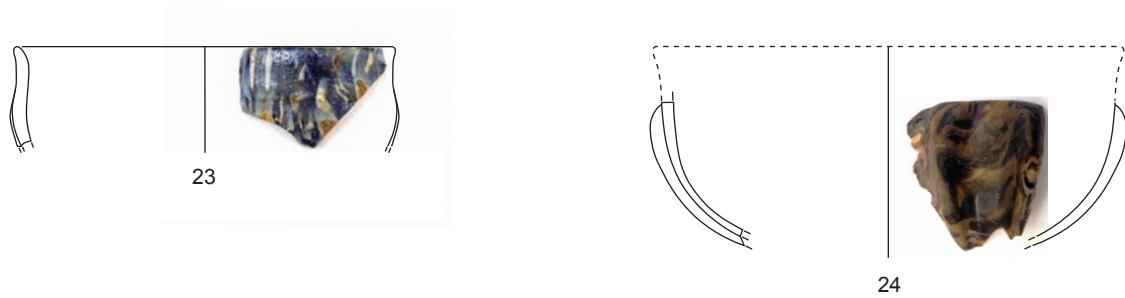
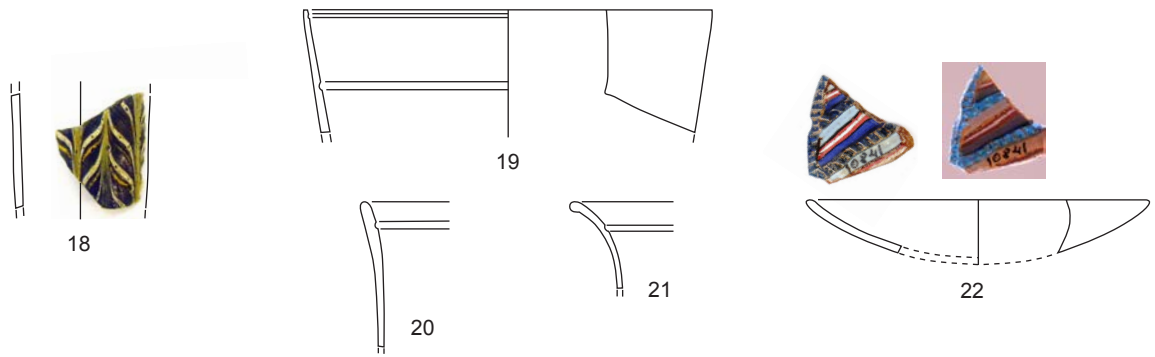

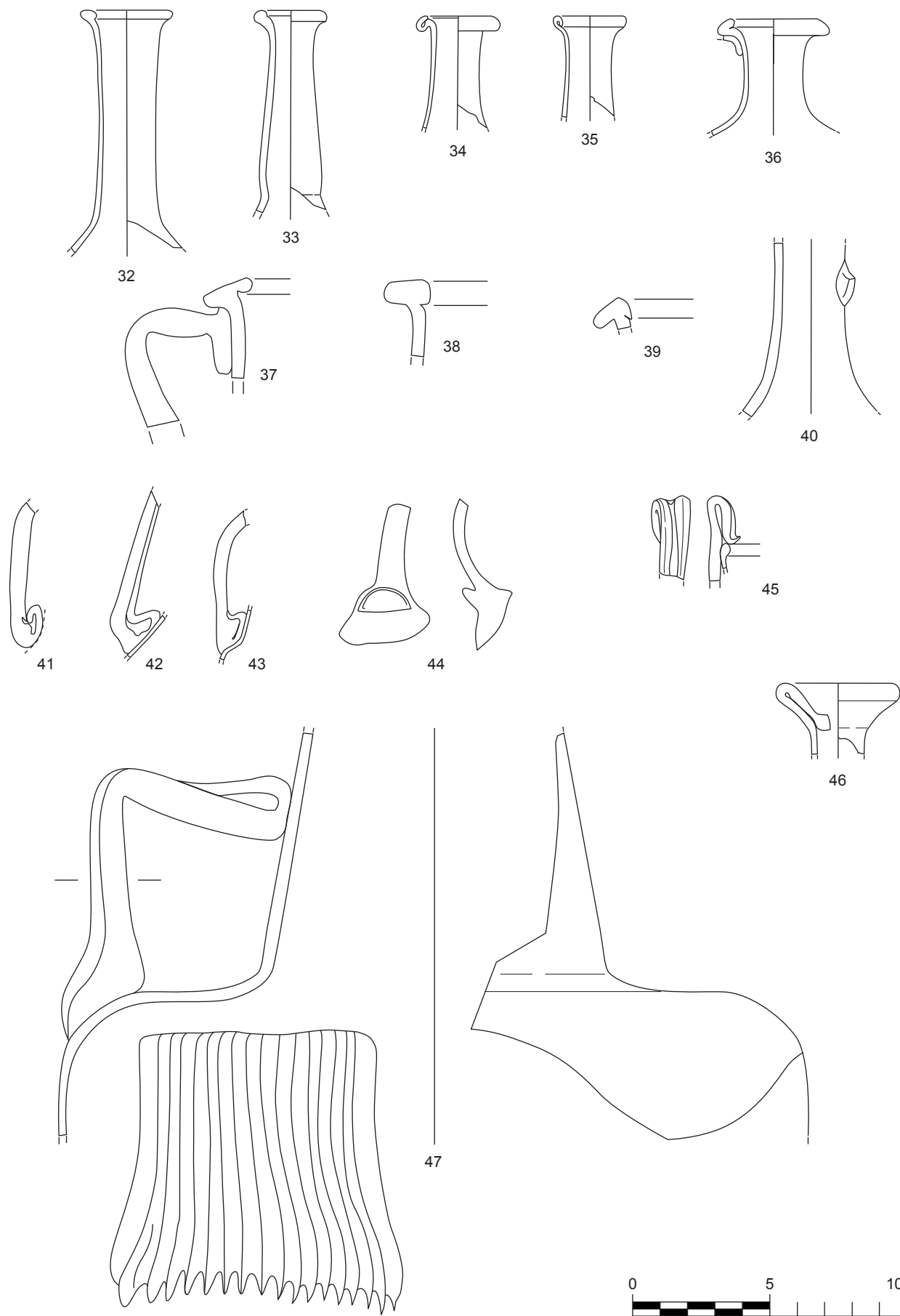

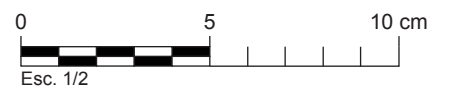
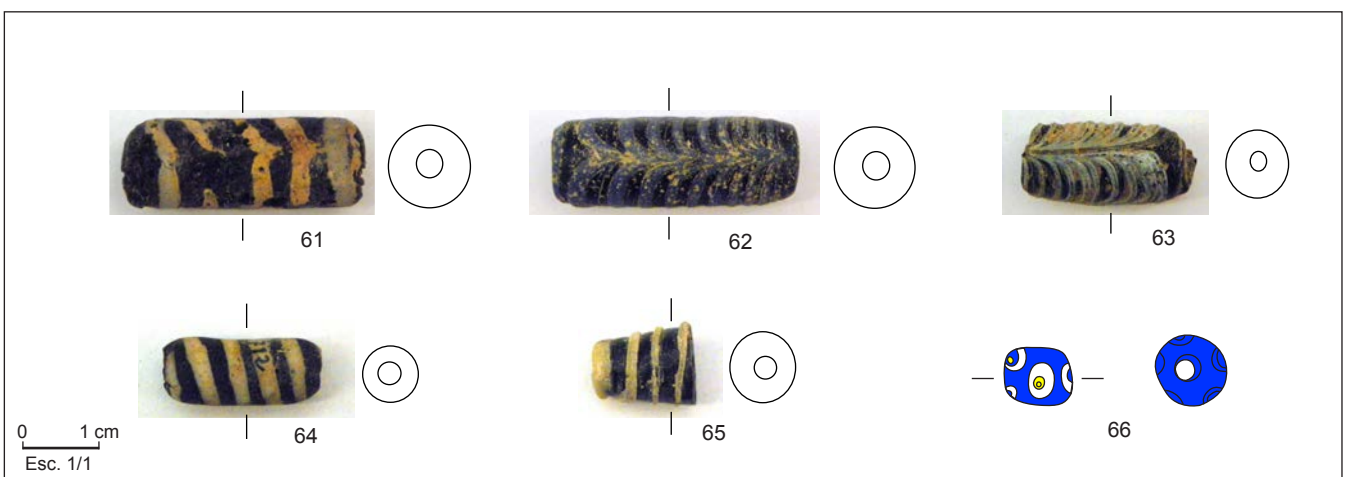
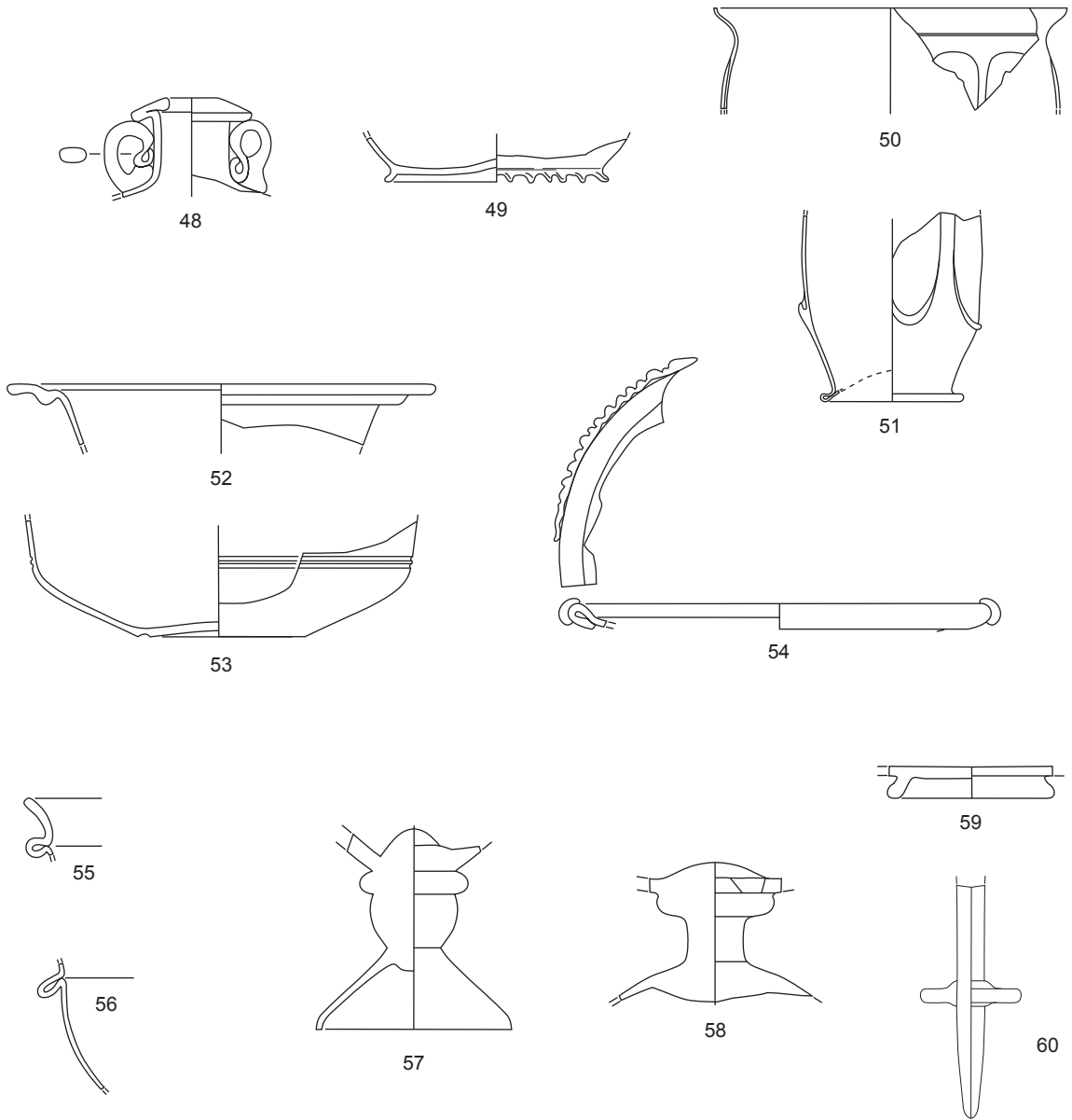

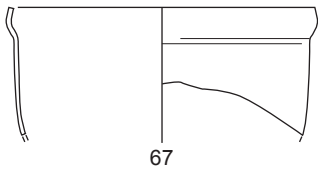

67

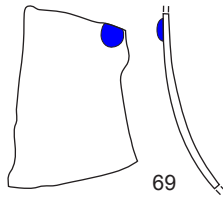

69

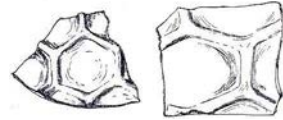

Dibuix de Serra Vilaró 1929 p.72, fig.52 i 53

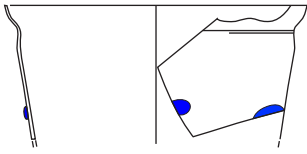

68

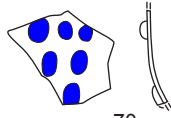

70

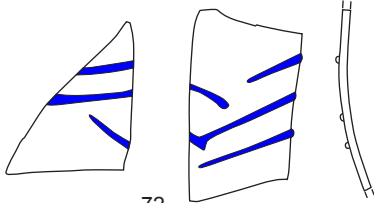
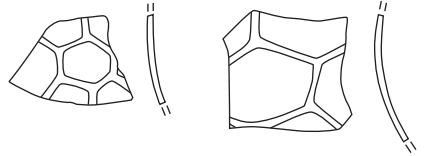

72

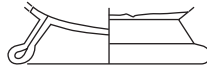

73

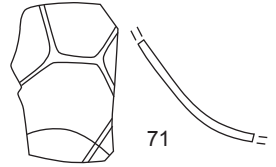

71

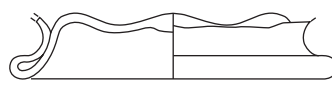

74



75

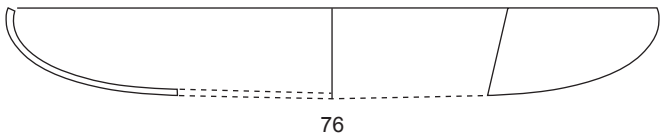

76

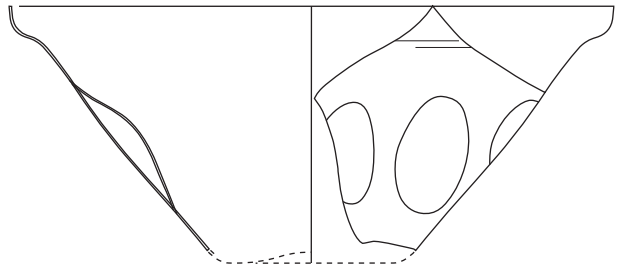

79

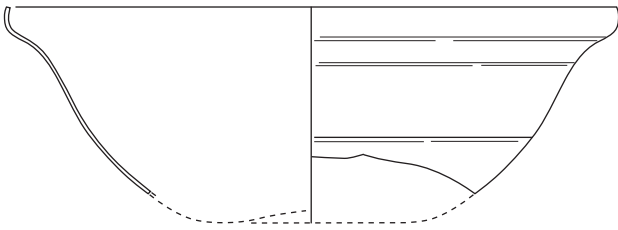

77

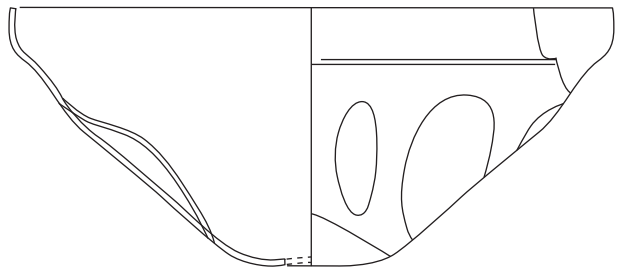

80



78

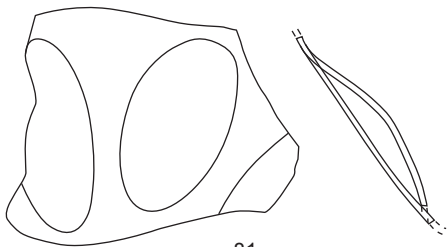

81

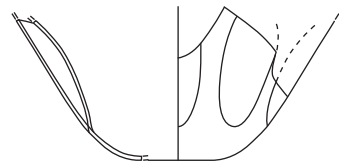

82

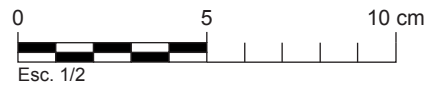

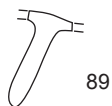
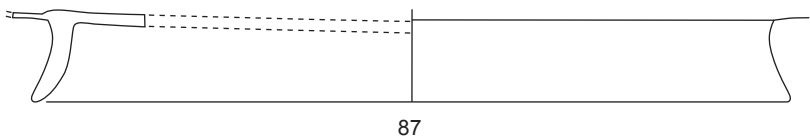
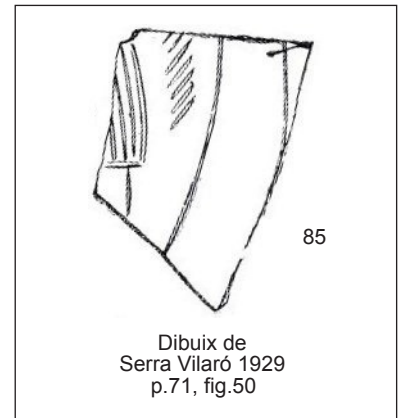
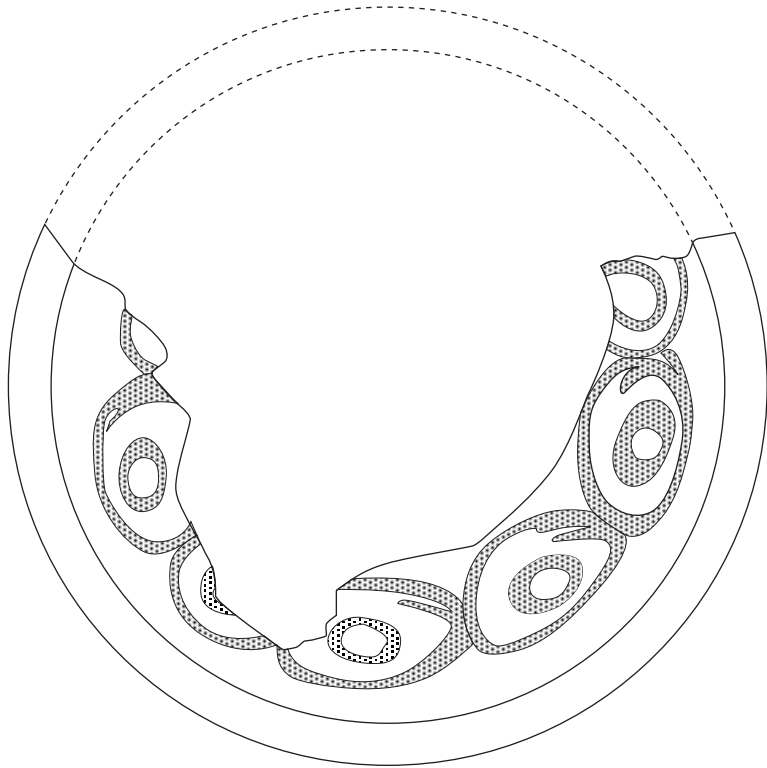
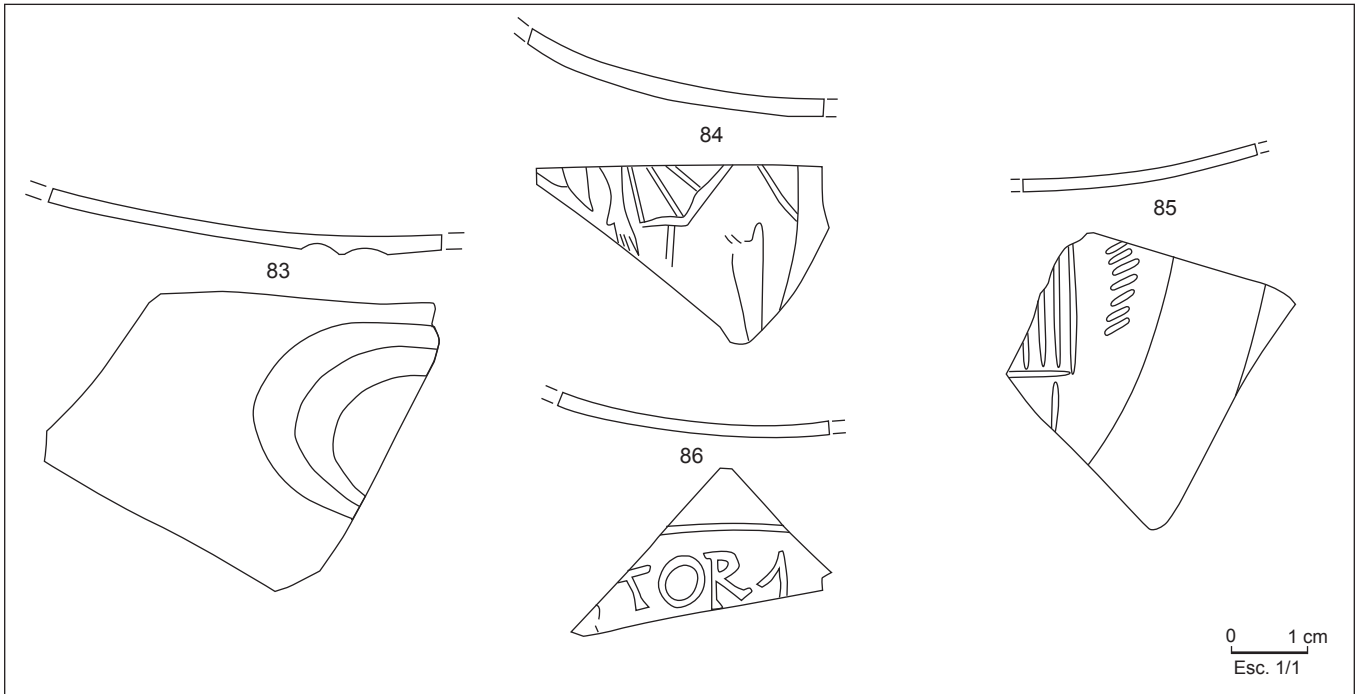

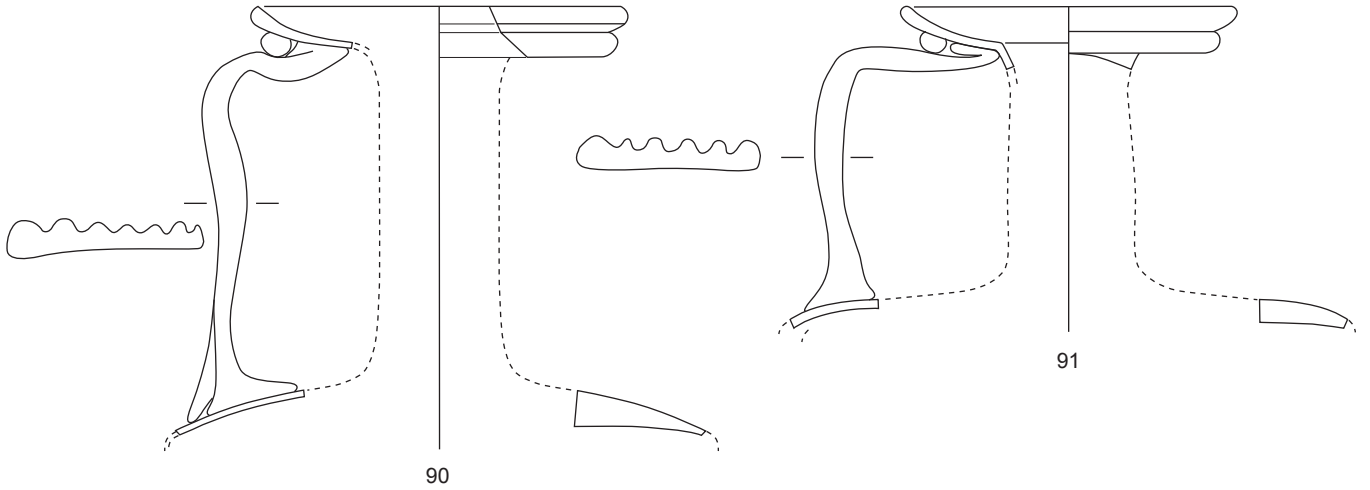

90

91

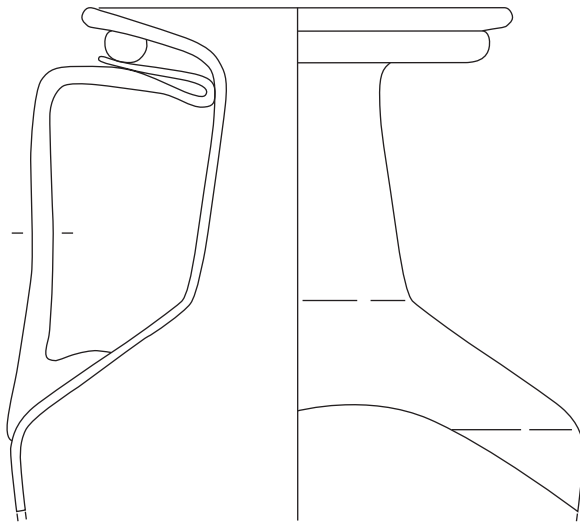
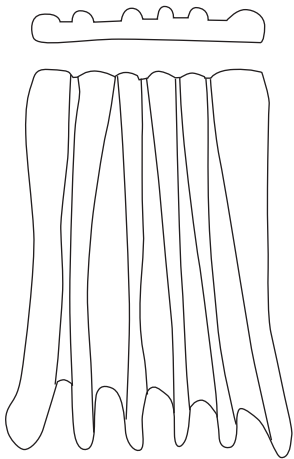

92

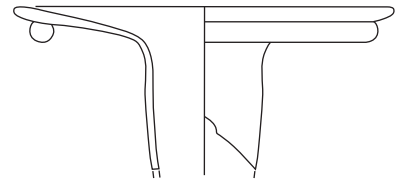

93

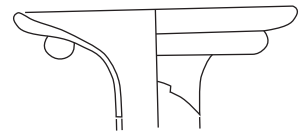

94

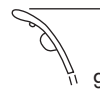

96



97



98



99

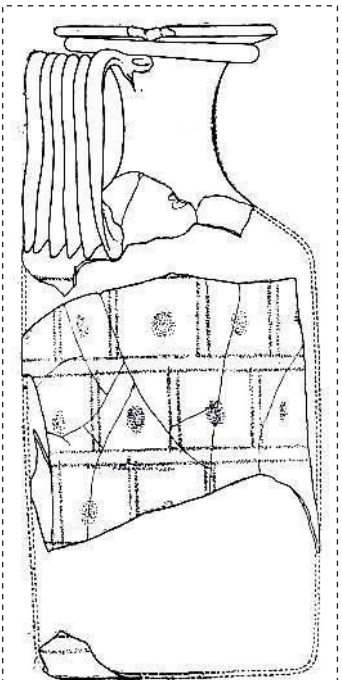

Dibuix amb la restitució d'una ampolla abrasada  
Serra Vilaró 1929, p.71, fig.48  
Escala aproximada 1/4

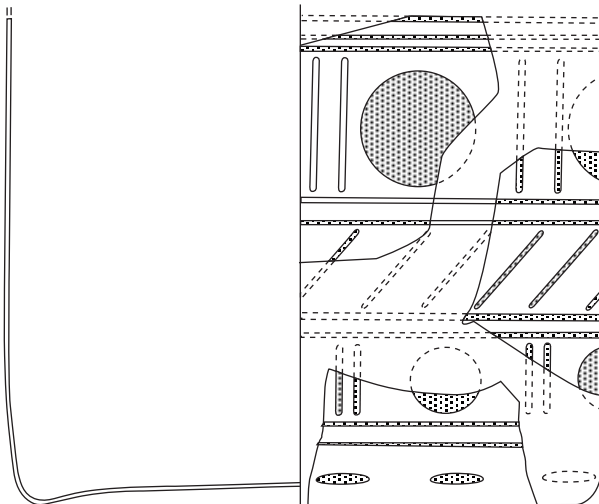

95

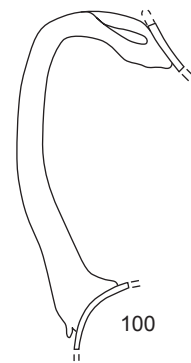

100

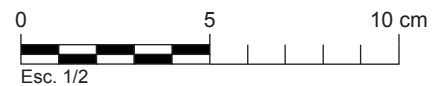

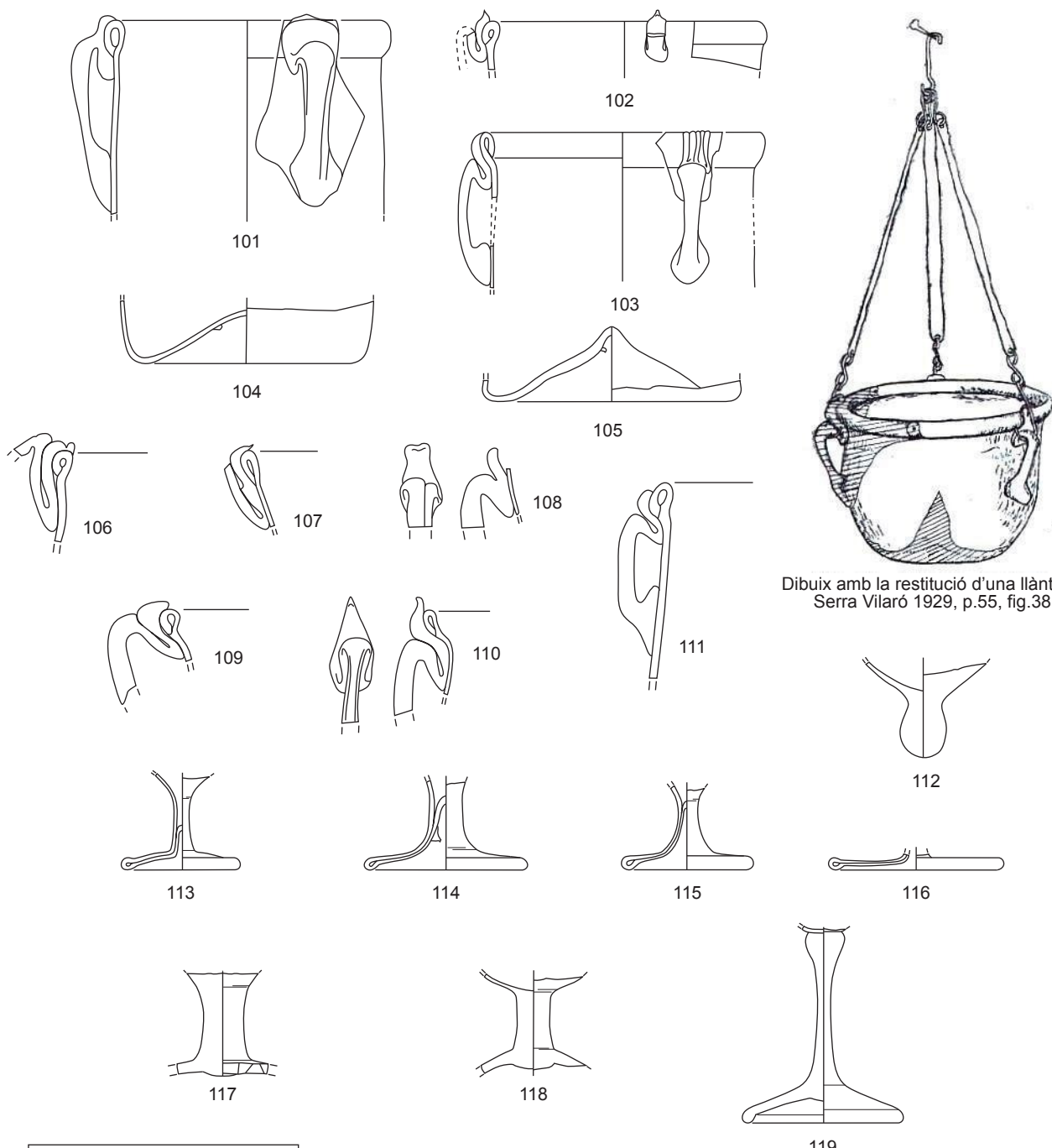

Dibuix amb la restitució d'una llàntia Serra Vilaró 1929, p.55, fig.38



Museu Necròpolis Paleocristiana  
NP-2300  
MNAT - Clixé 14939

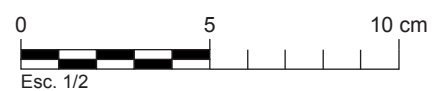
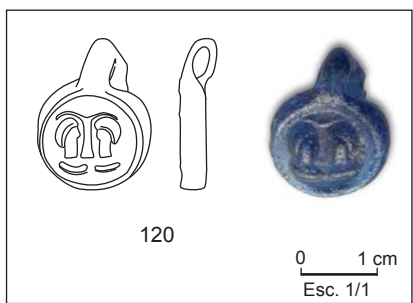

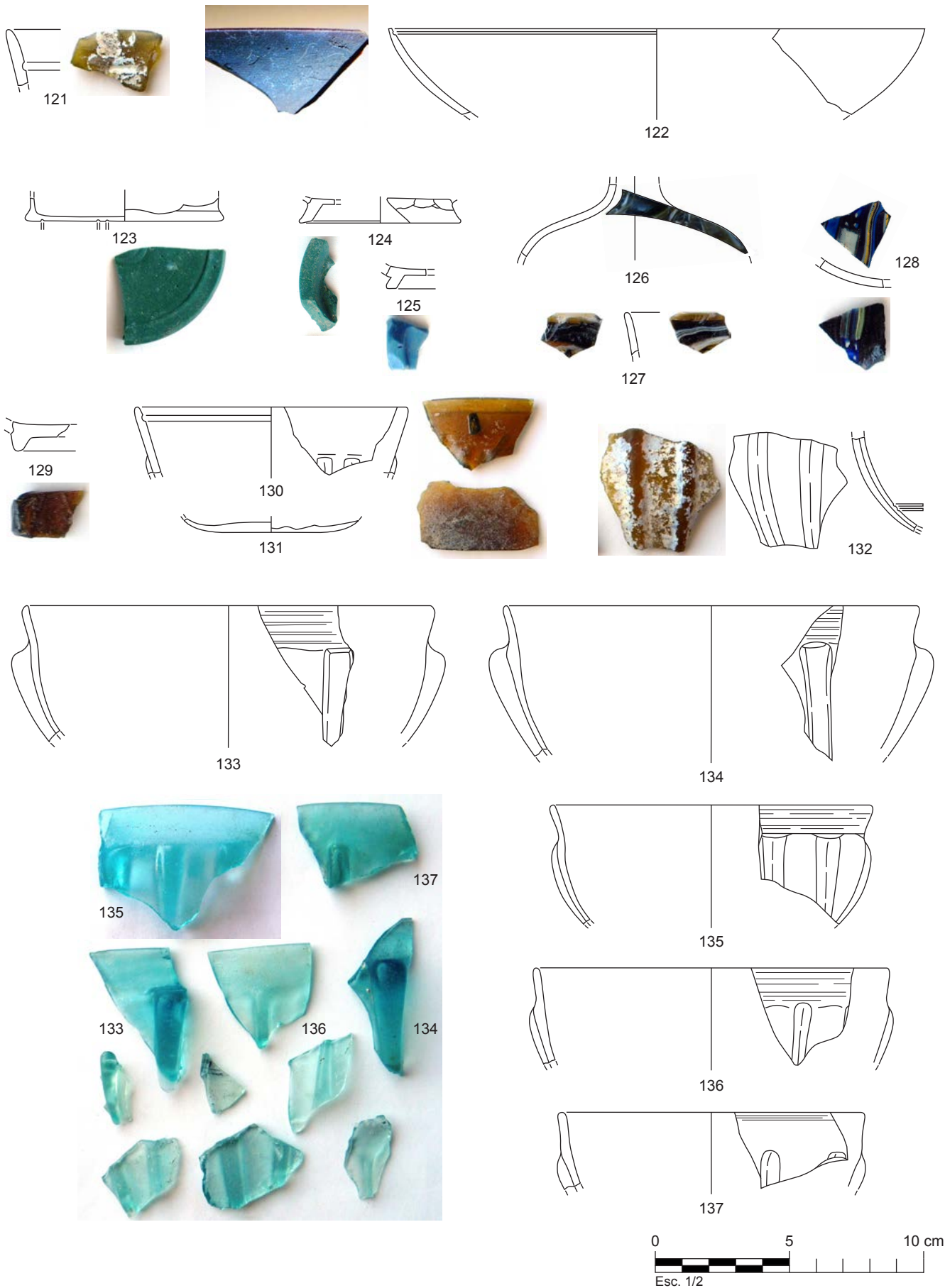



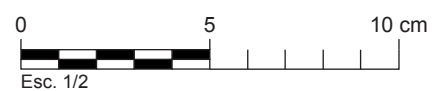
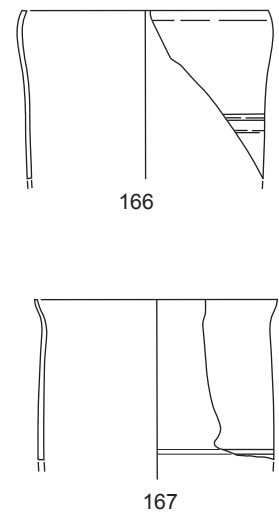
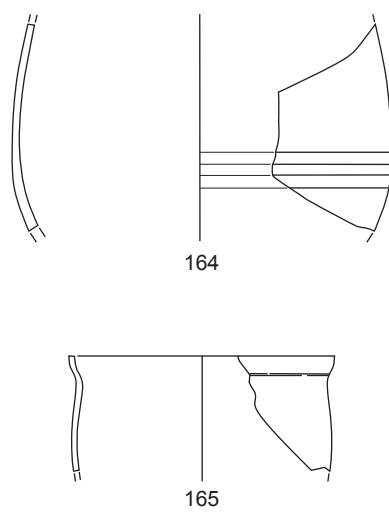
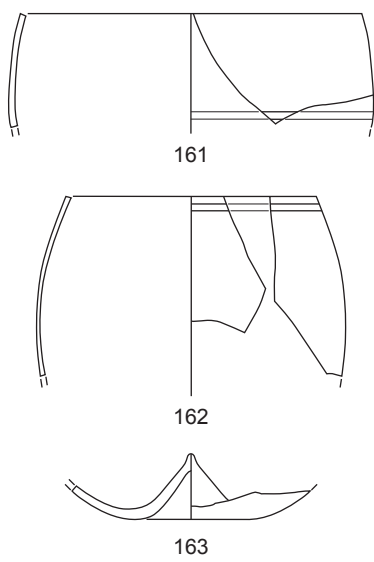
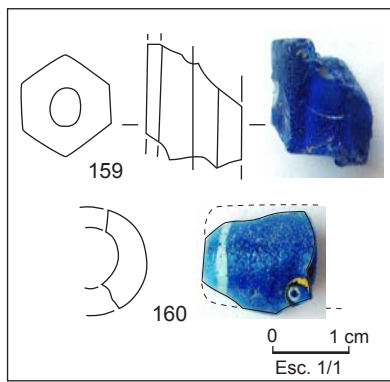
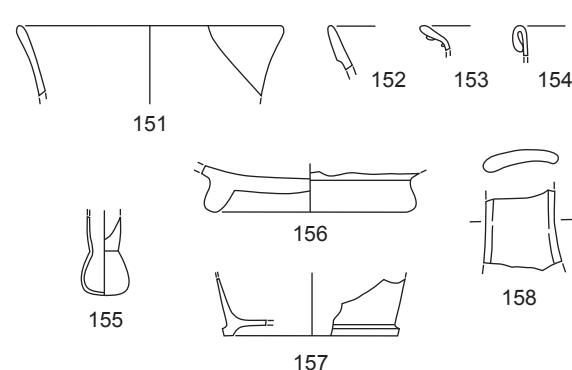
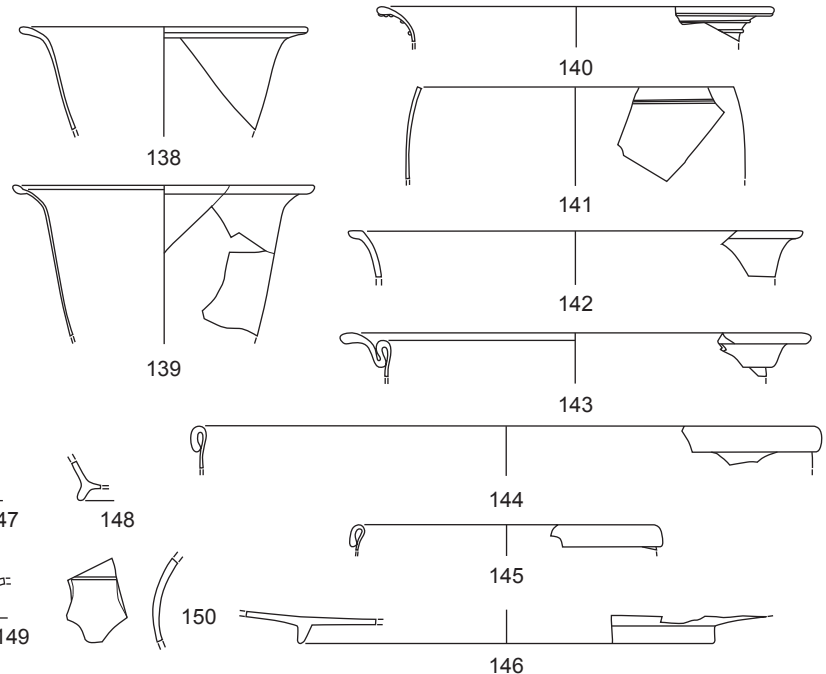

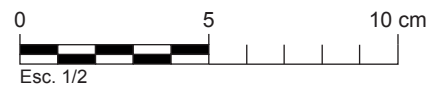
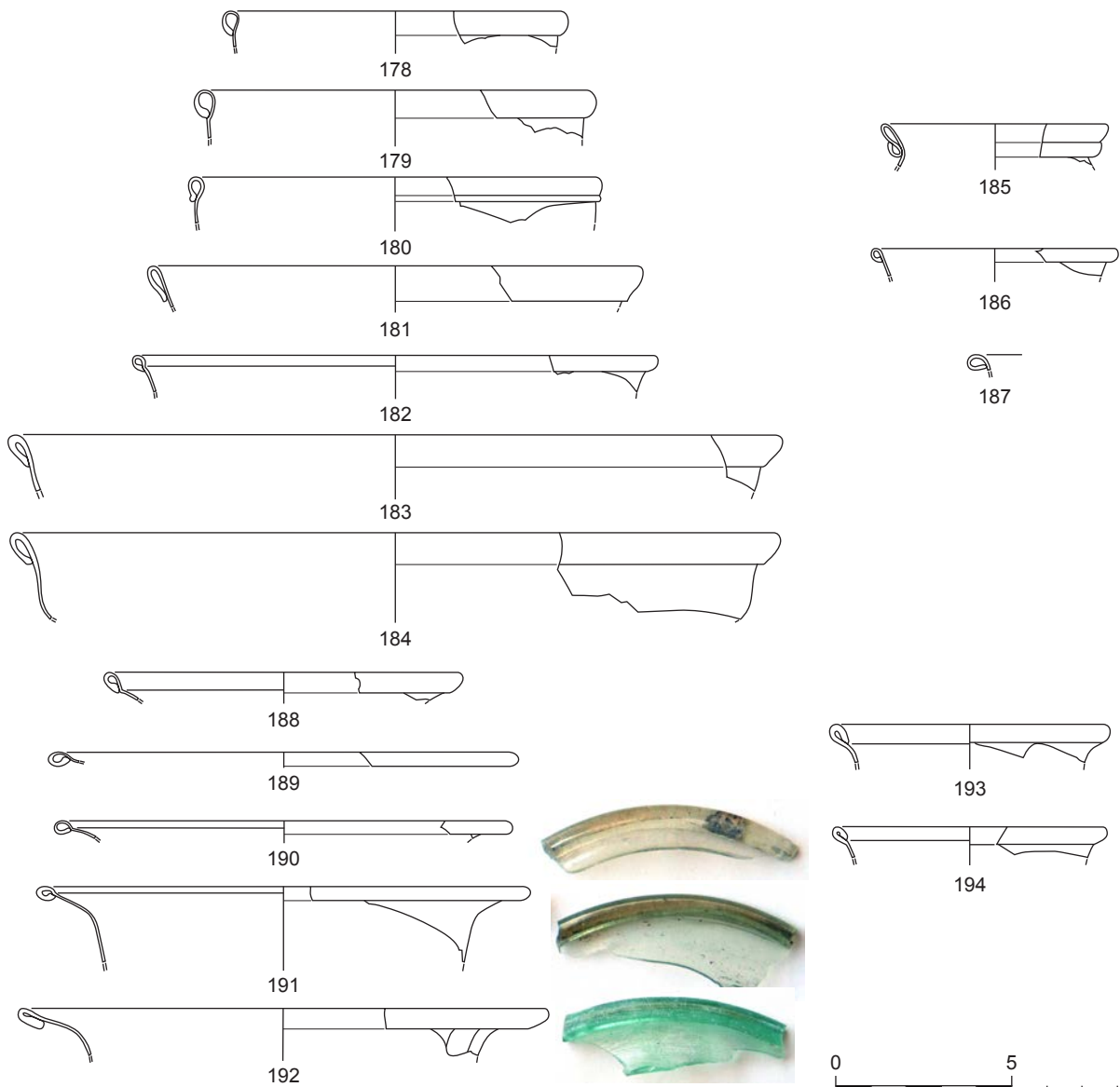
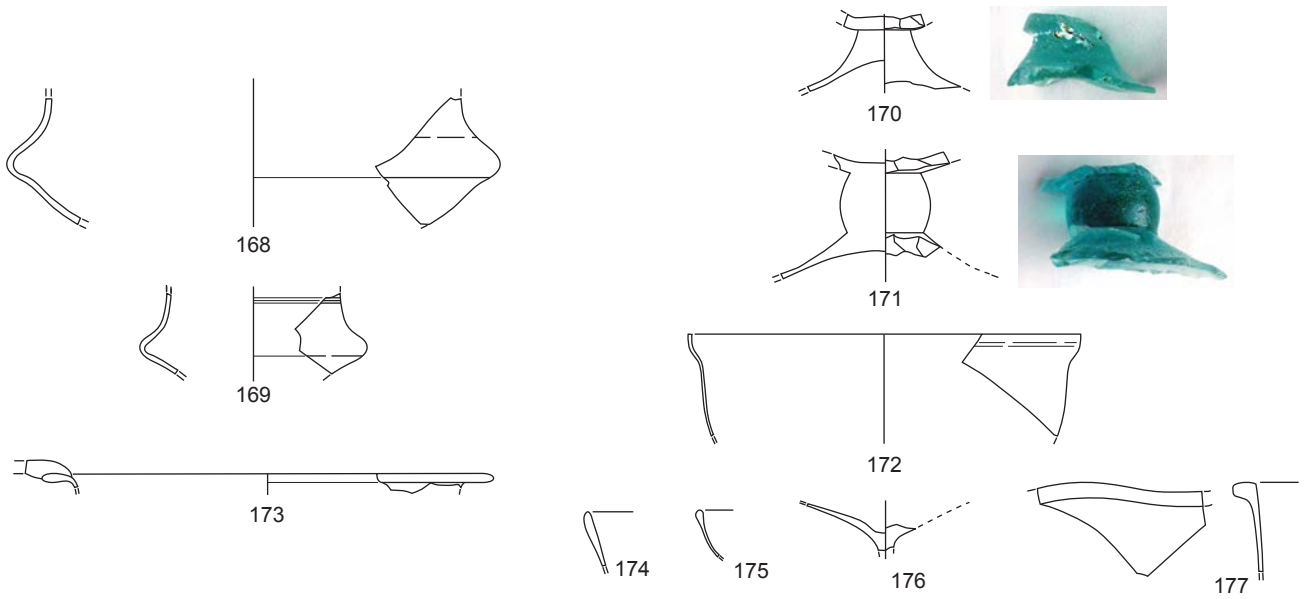

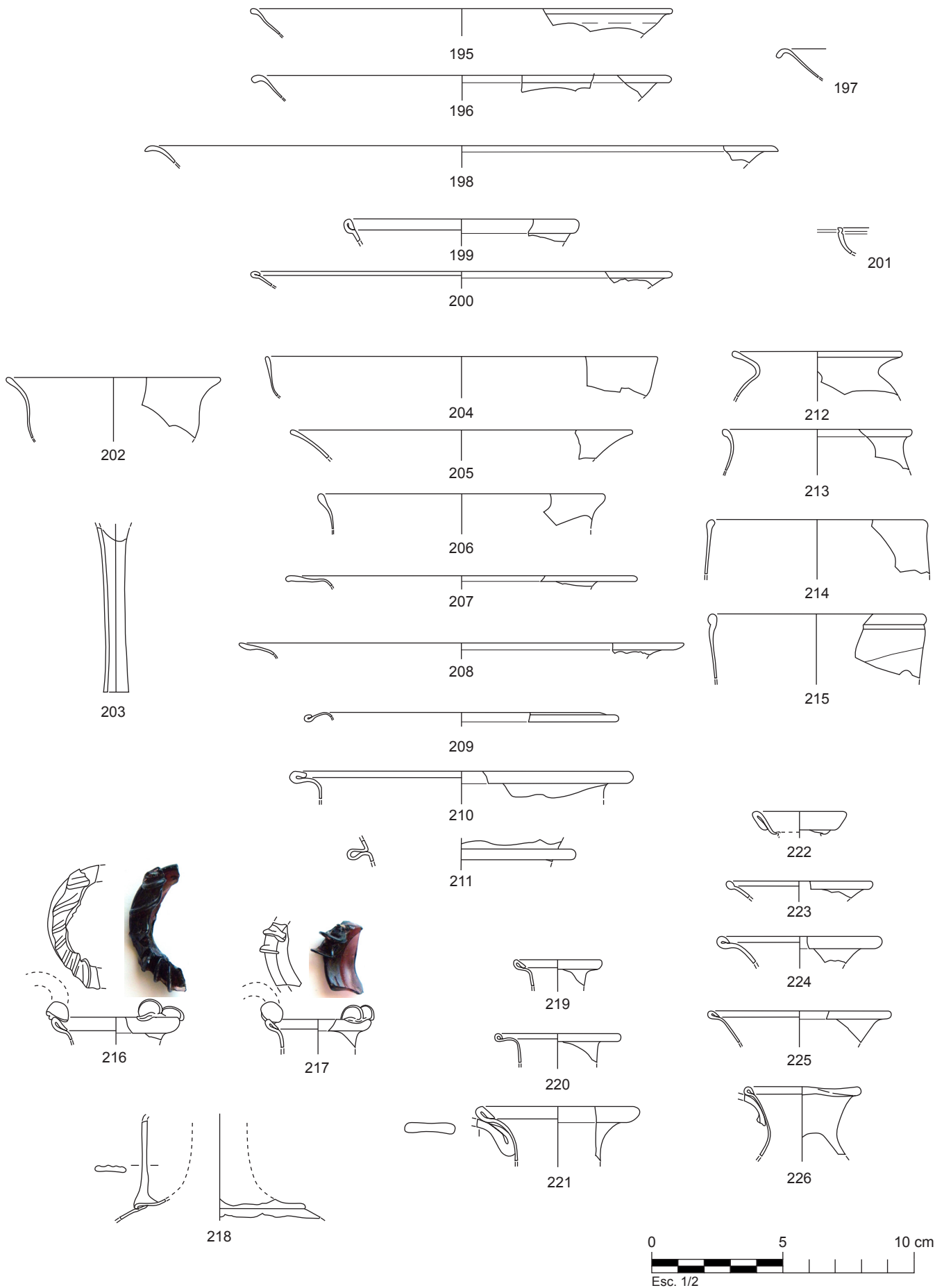

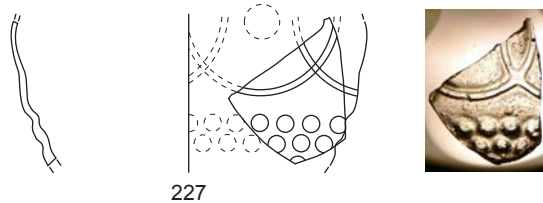

227

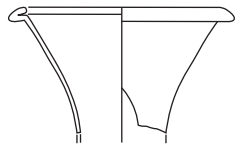

228

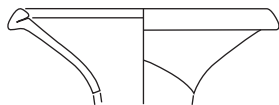

229



230

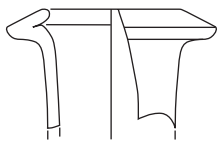

231



248

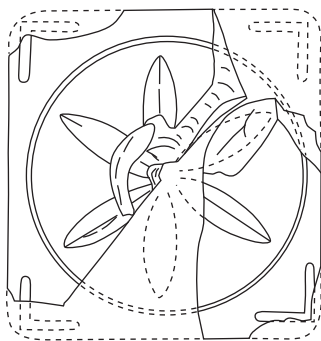

249

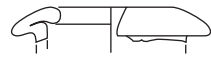

232



233



234

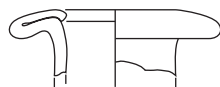

235



236

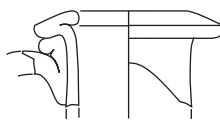

237



238

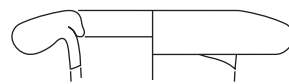

239



240

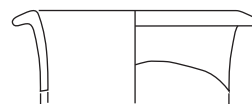

241

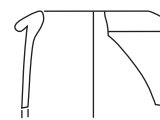

242

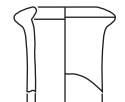

243

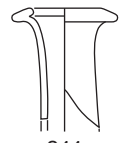

244

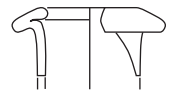

245

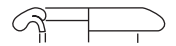

246



247

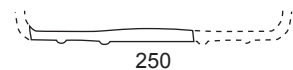

250

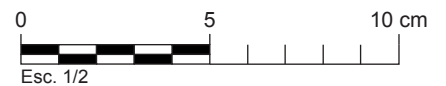
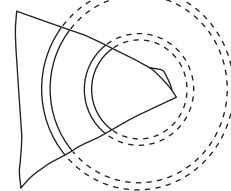

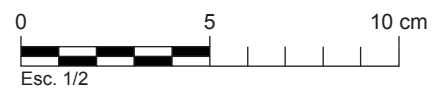
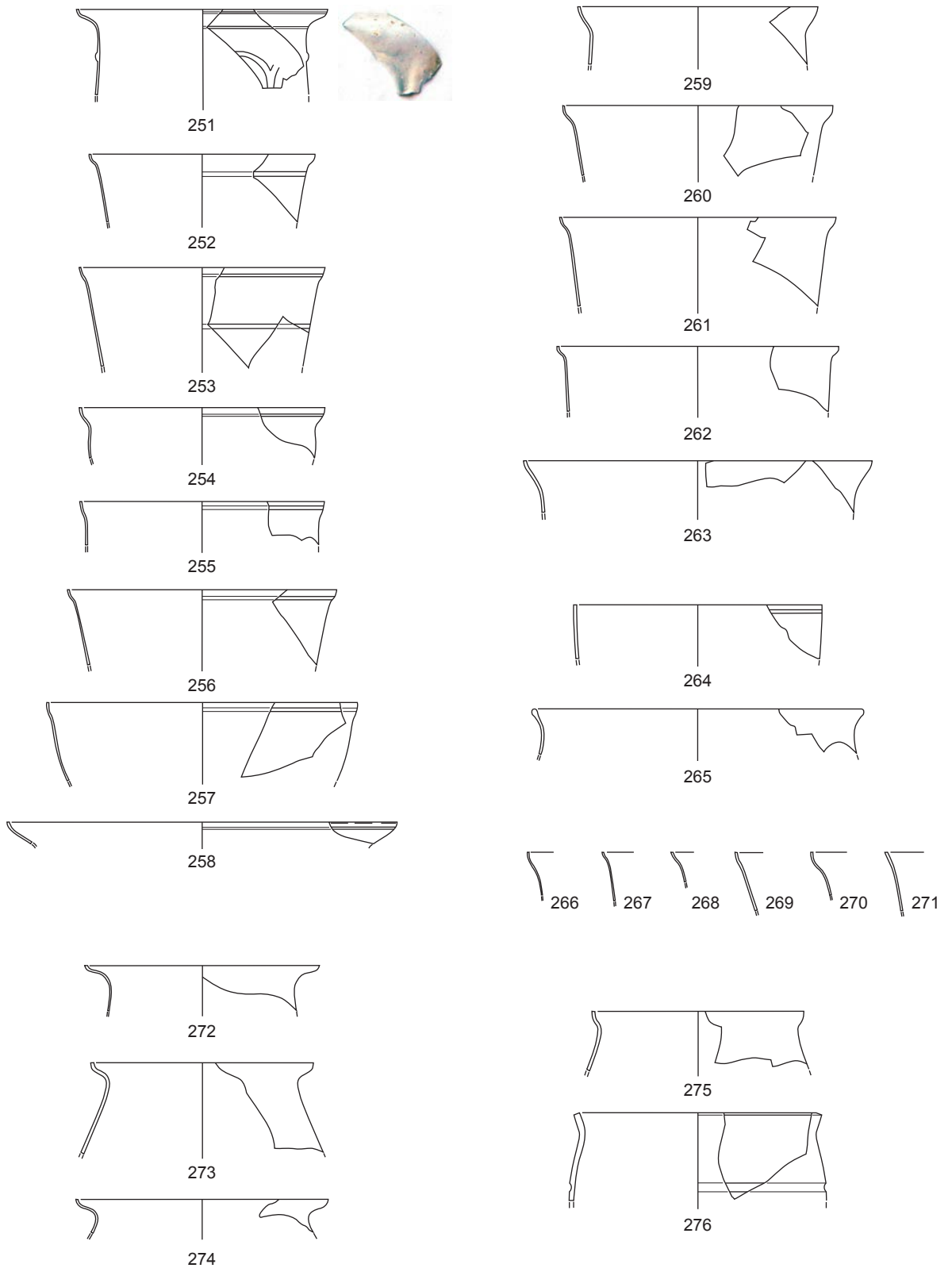

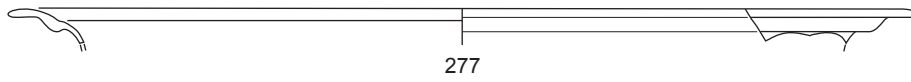

277



278

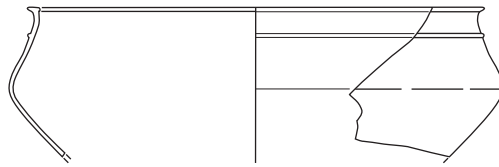

279

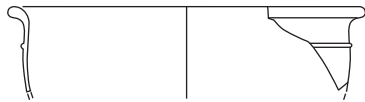

280

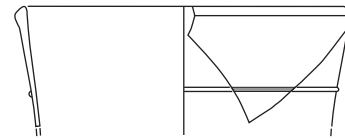

283



281

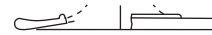

284



282



285

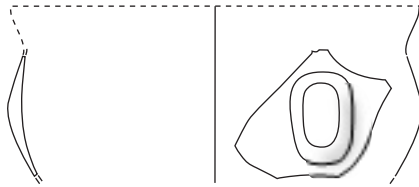

286

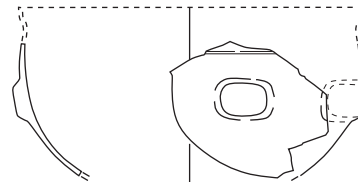

287



288

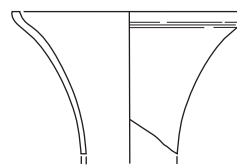

291

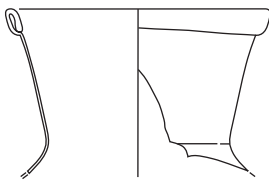
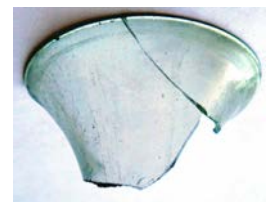

289



292

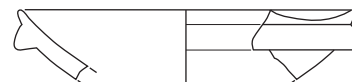

293



290

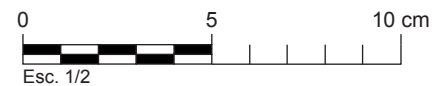

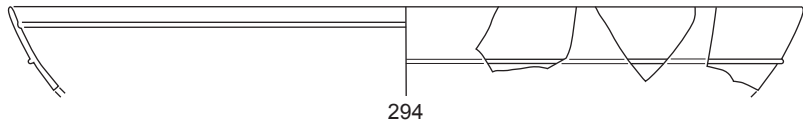

294

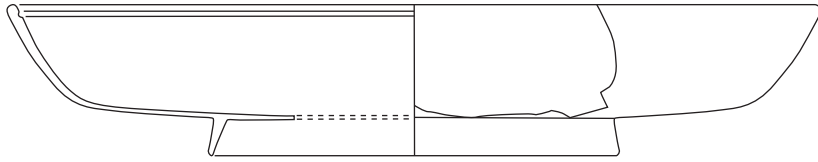

295

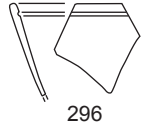

296

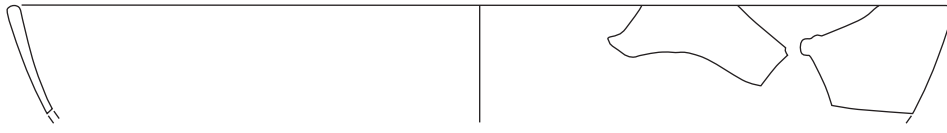

297



298

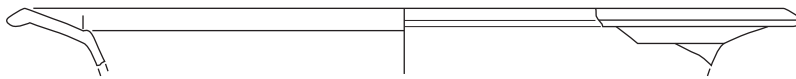

299

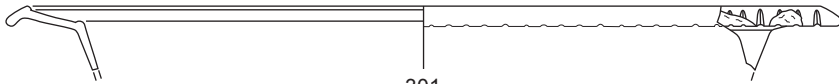

301

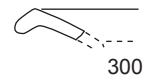

300

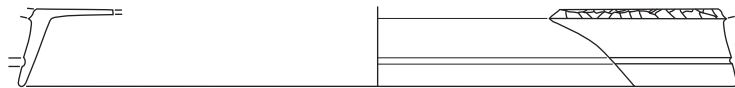

302

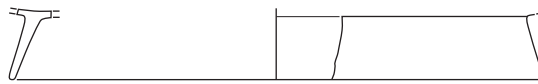

303



304

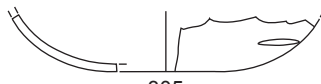

305

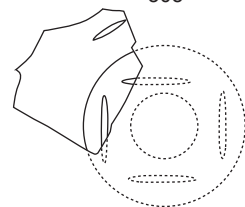

306

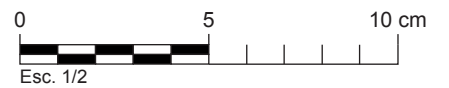
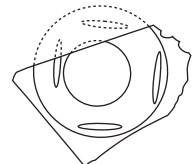

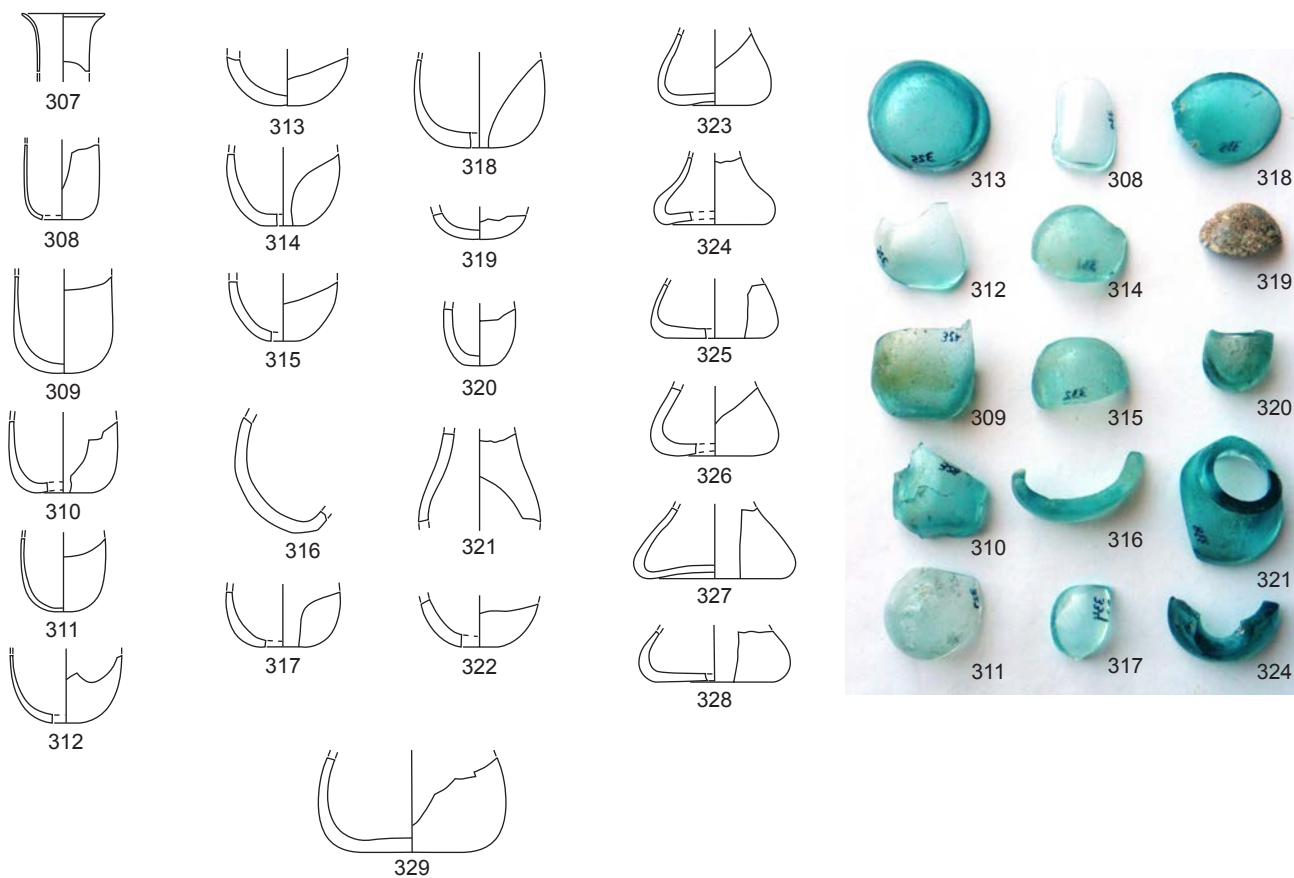

330 331 332



334



333



335

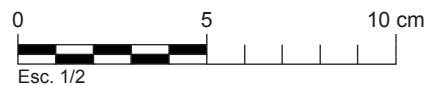



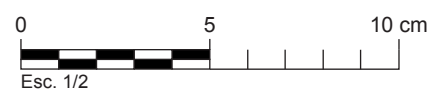
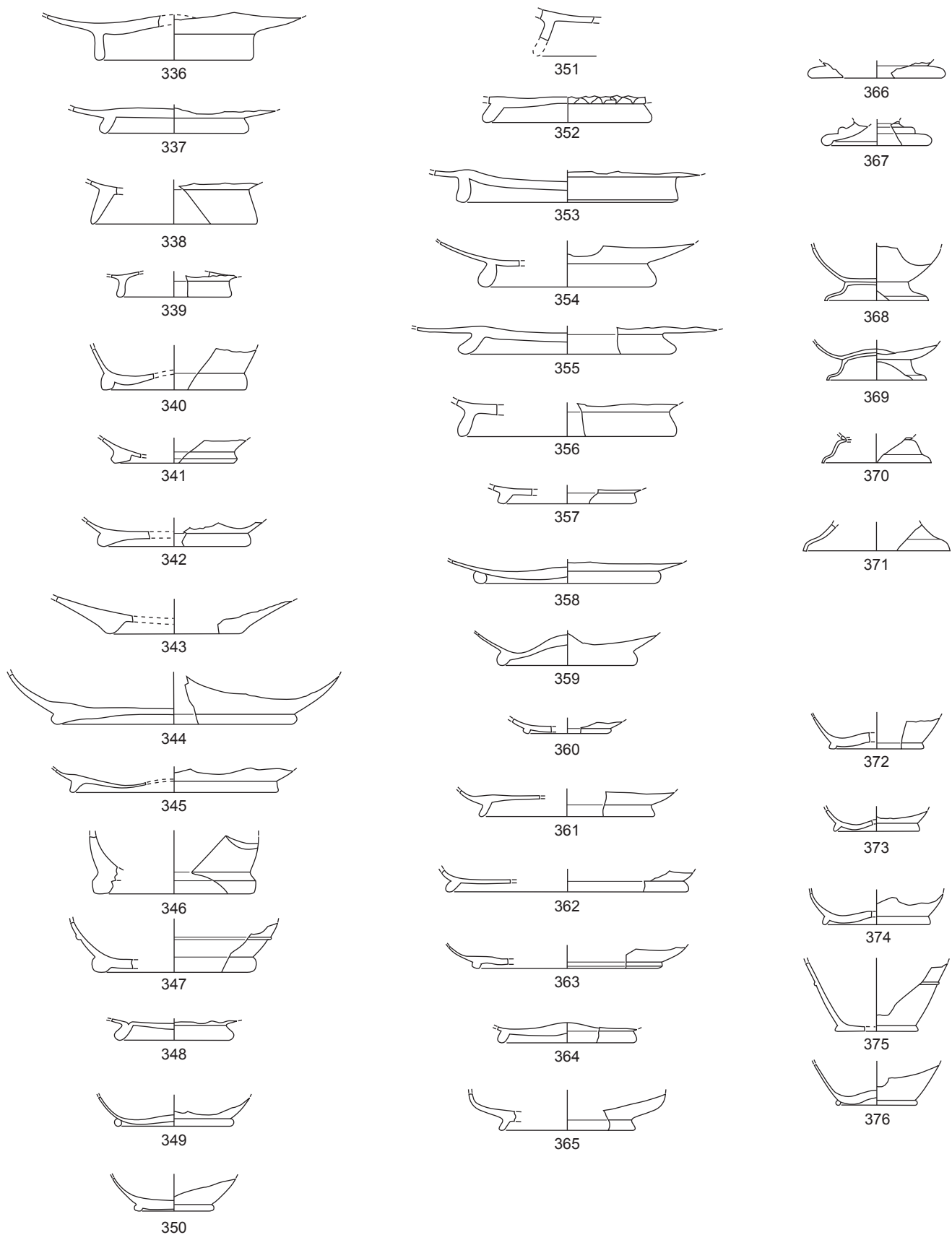

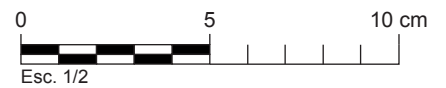
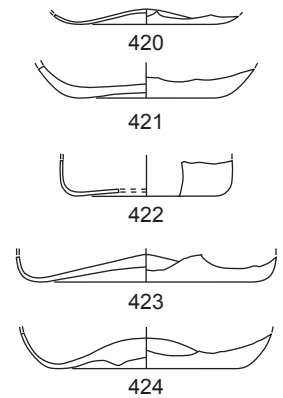
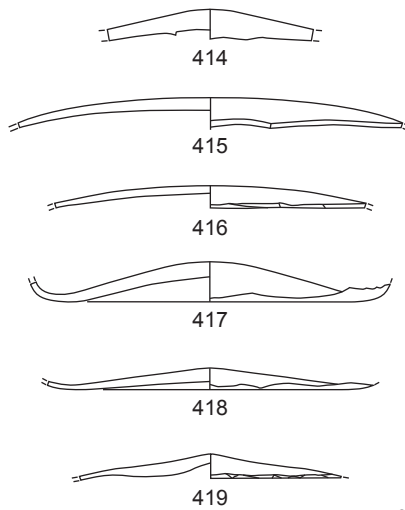
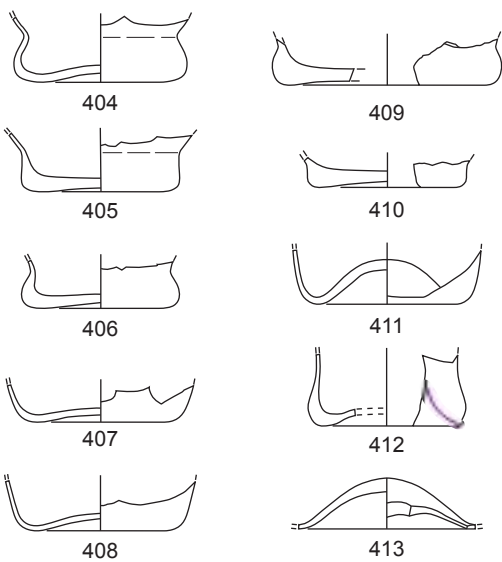
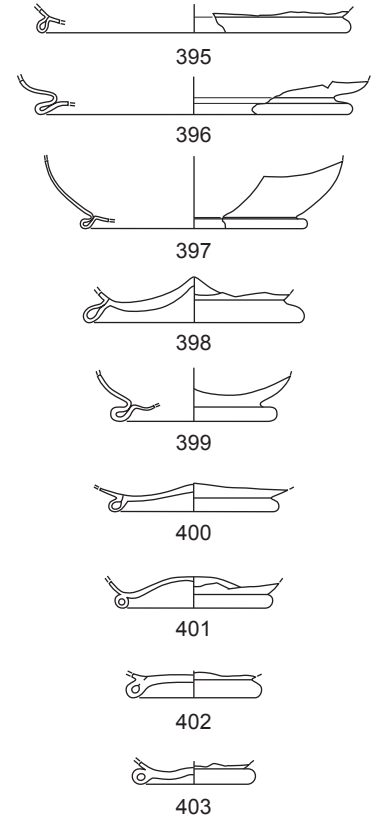
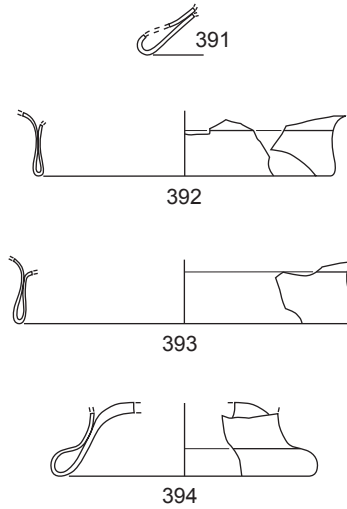
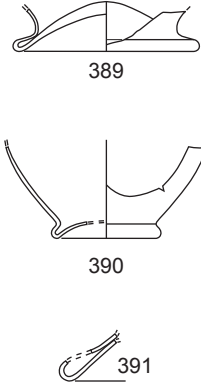
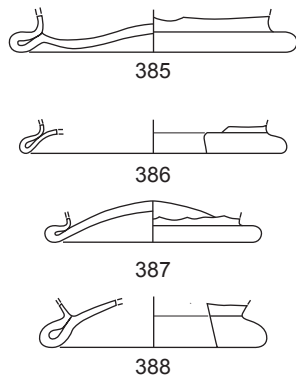
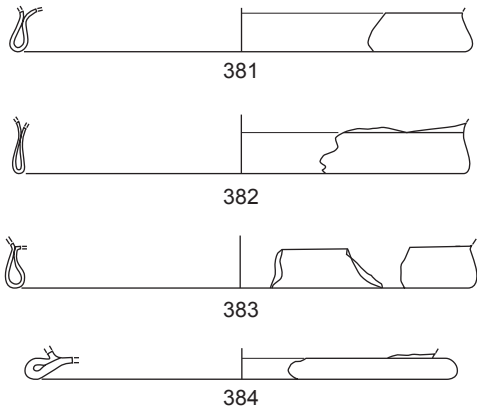
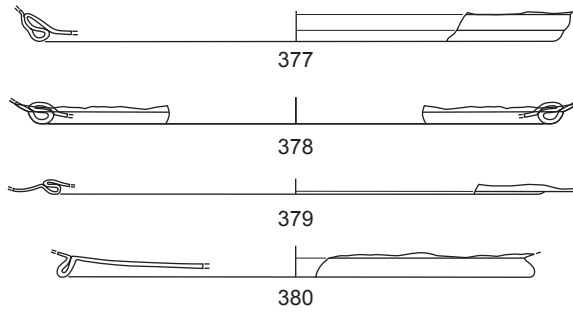

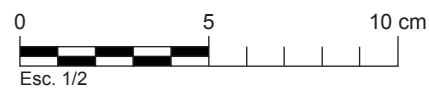
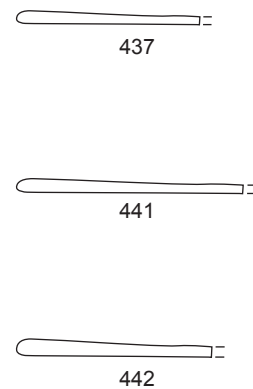
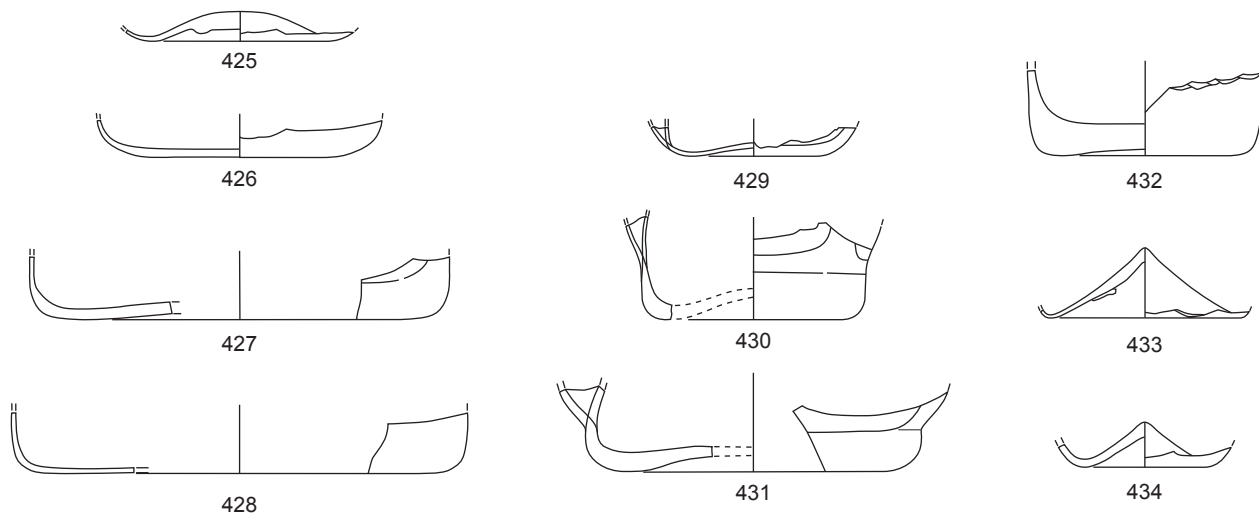

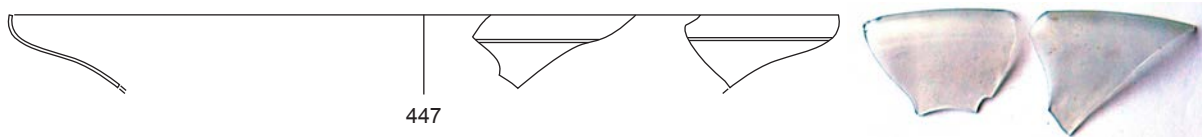

447

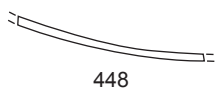

448

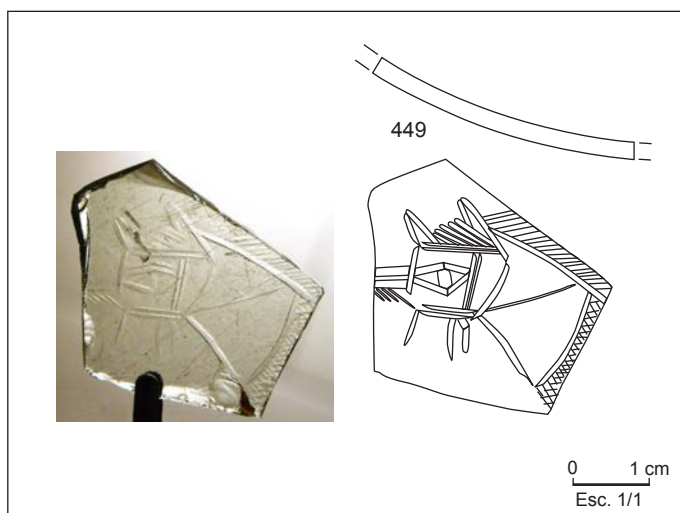
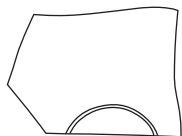

449

0 1 cm  
Esc. 1/1

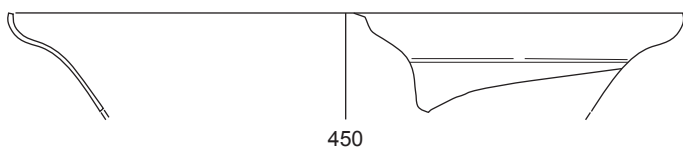

450

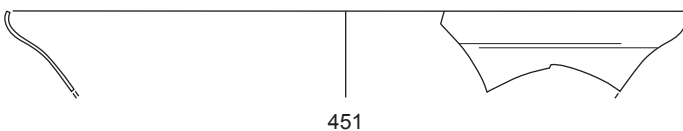

451



452

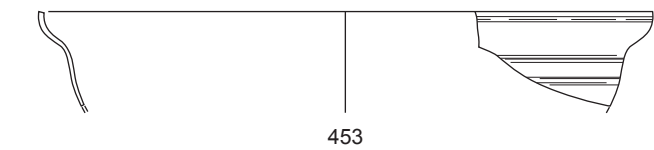

453

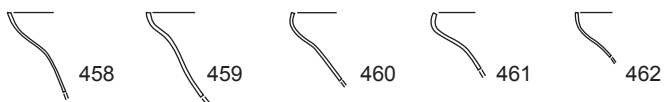

458

459

460

461

462



463

464

465

466

467

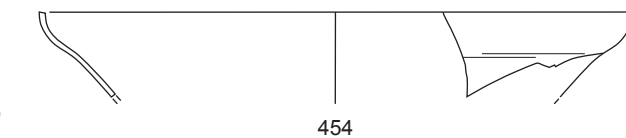

454



455



456



457

0 5 10 cm  
Esc. 1/2

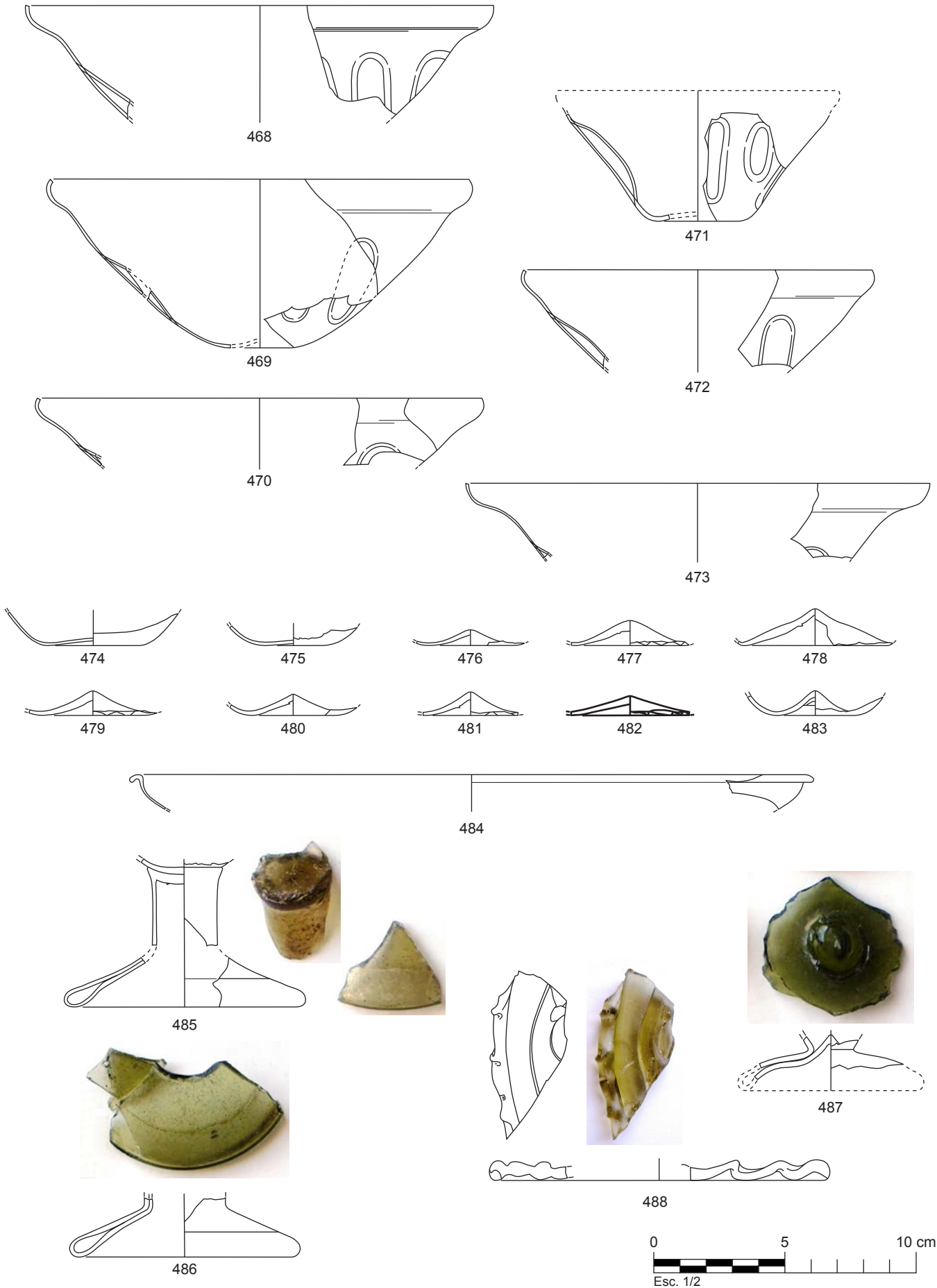

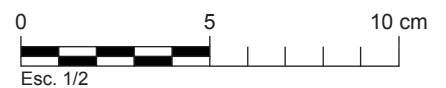
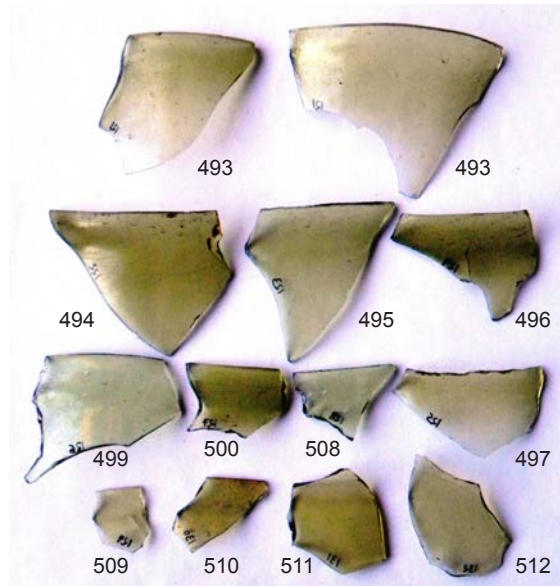

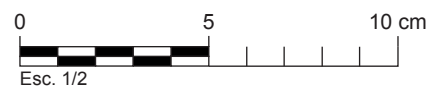
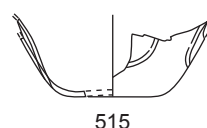
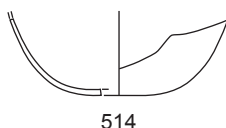
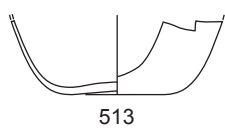
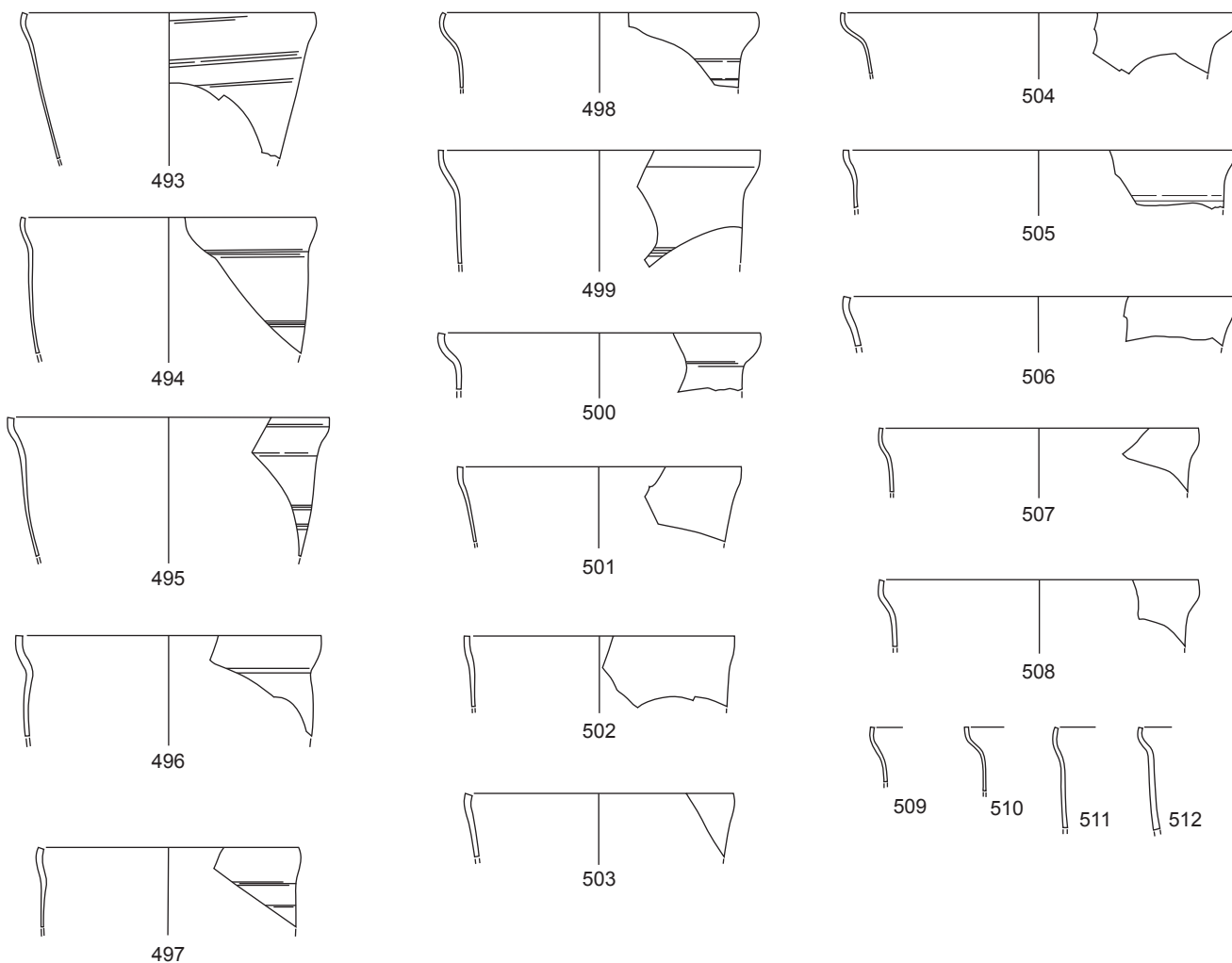
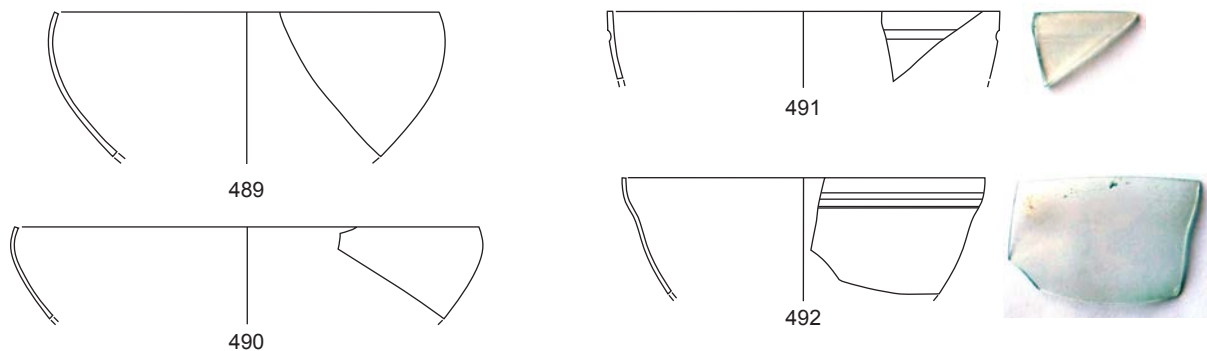

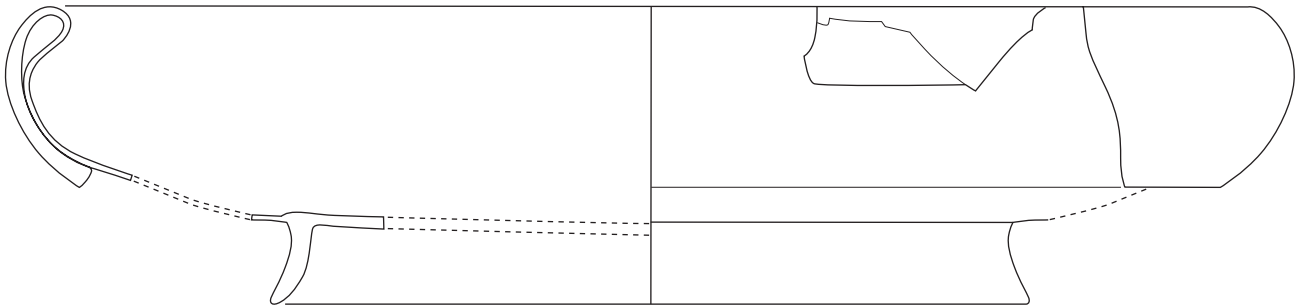
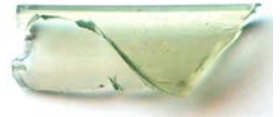
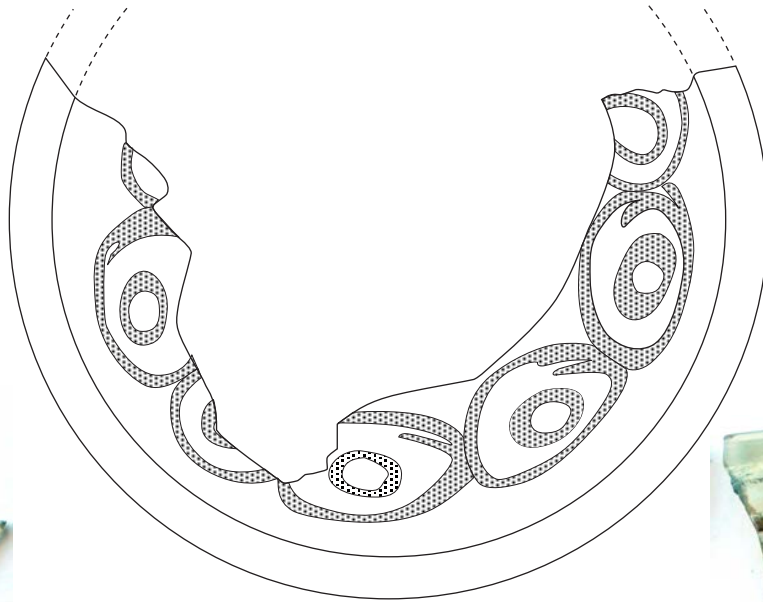
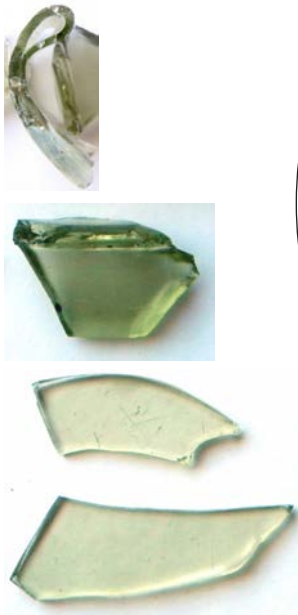

516

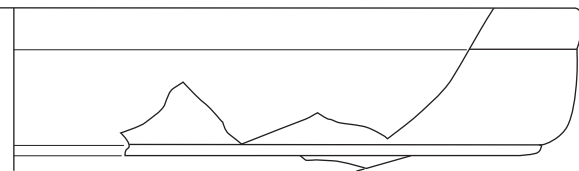
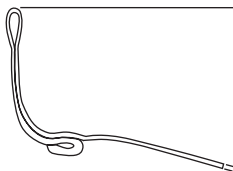

517

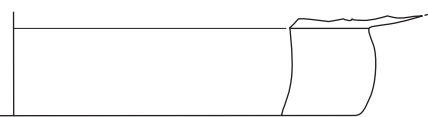
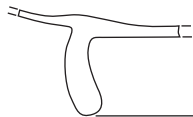
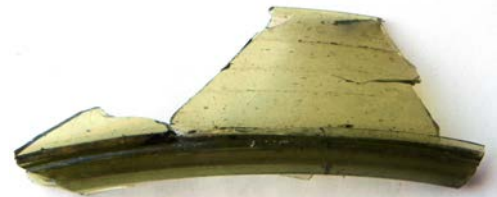

518

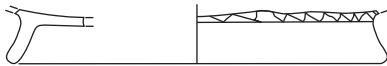

519

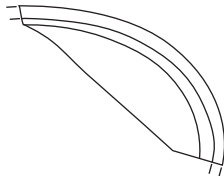

520



521

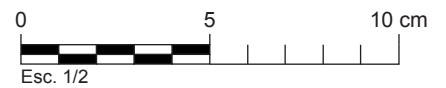



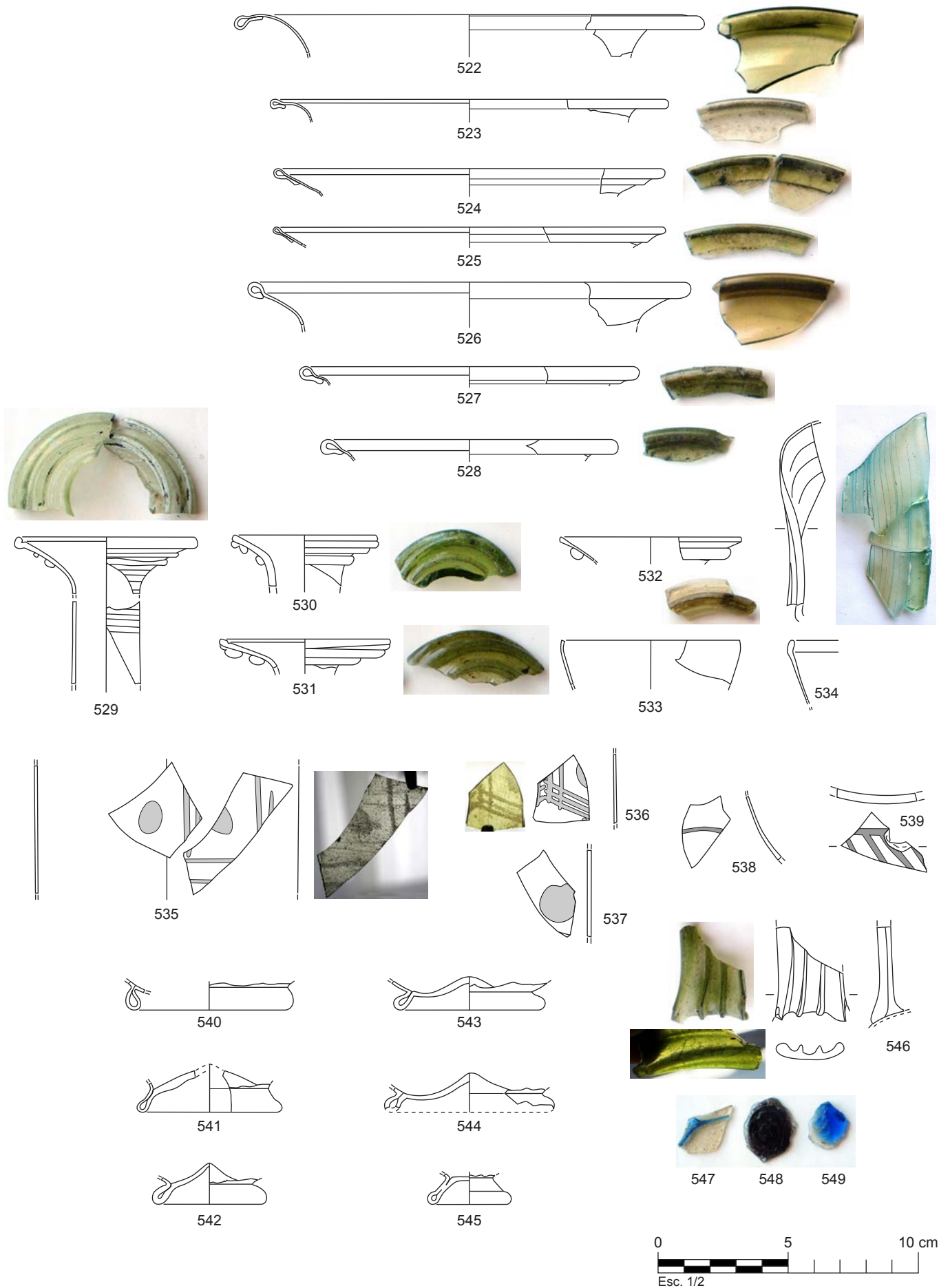

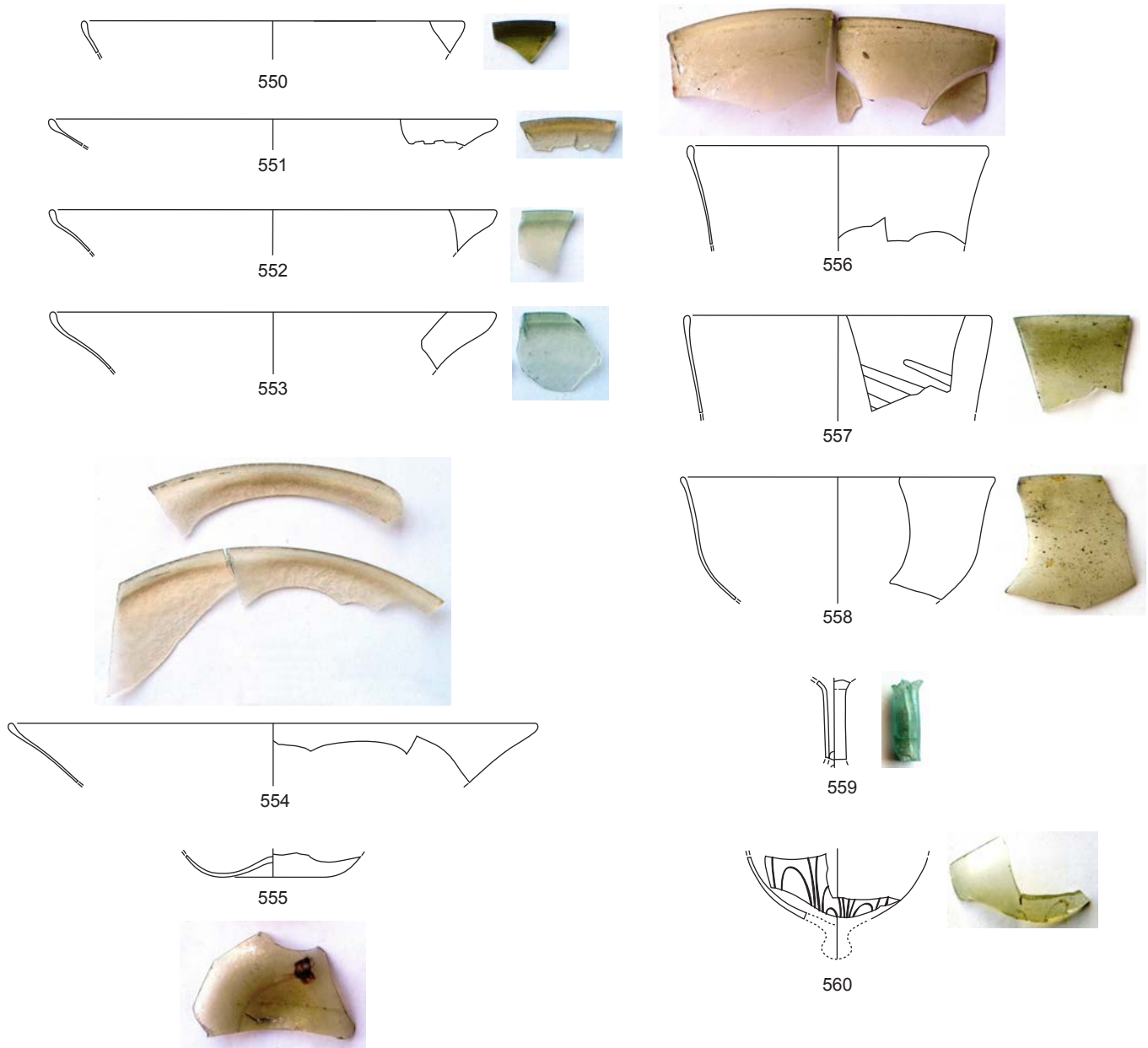

Fragment de vidre en brut / lingot i rebuig de producció

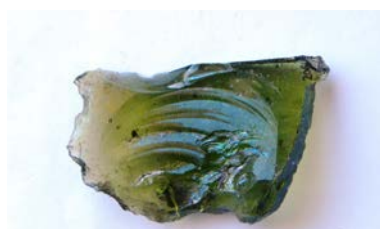

561

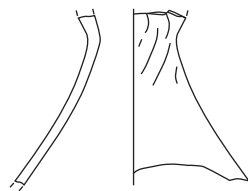

562

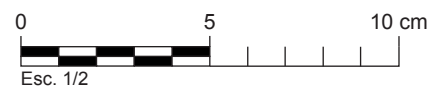

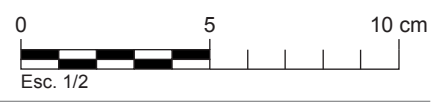
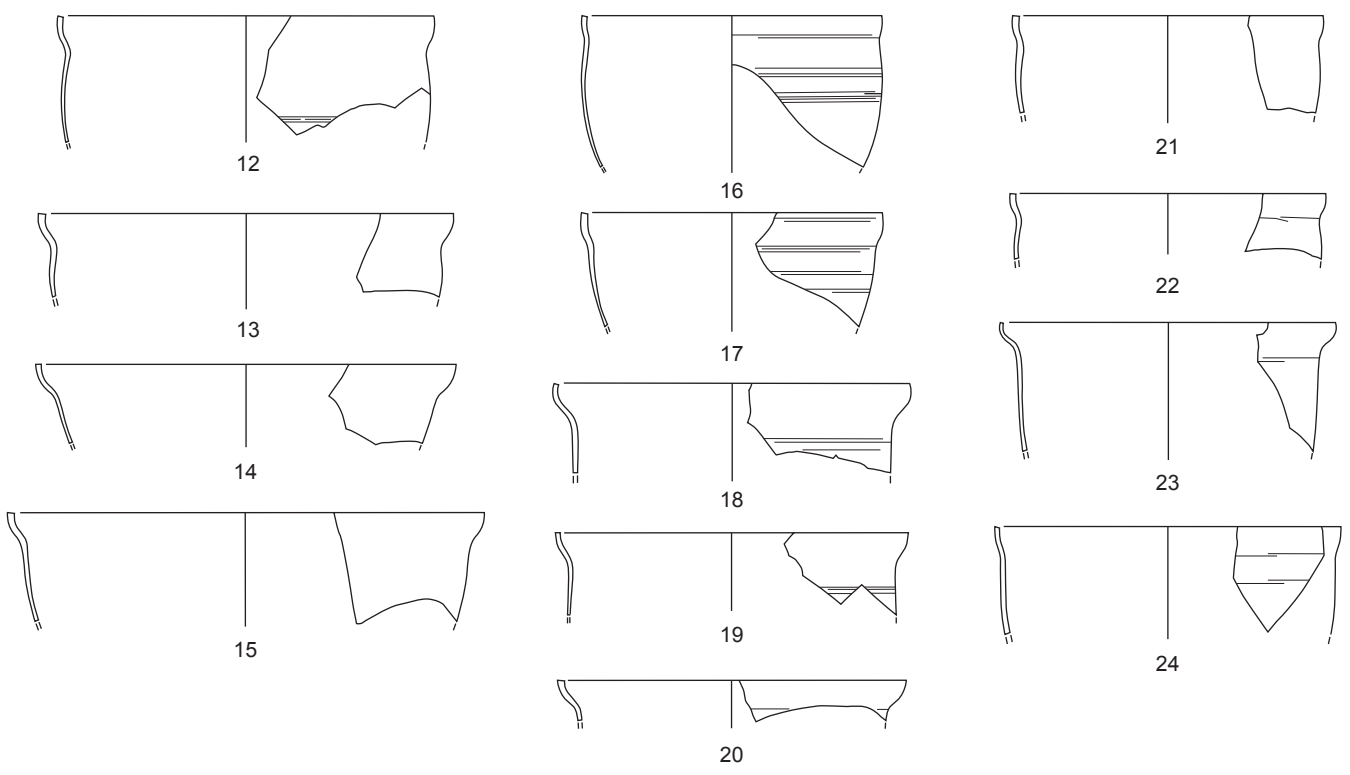
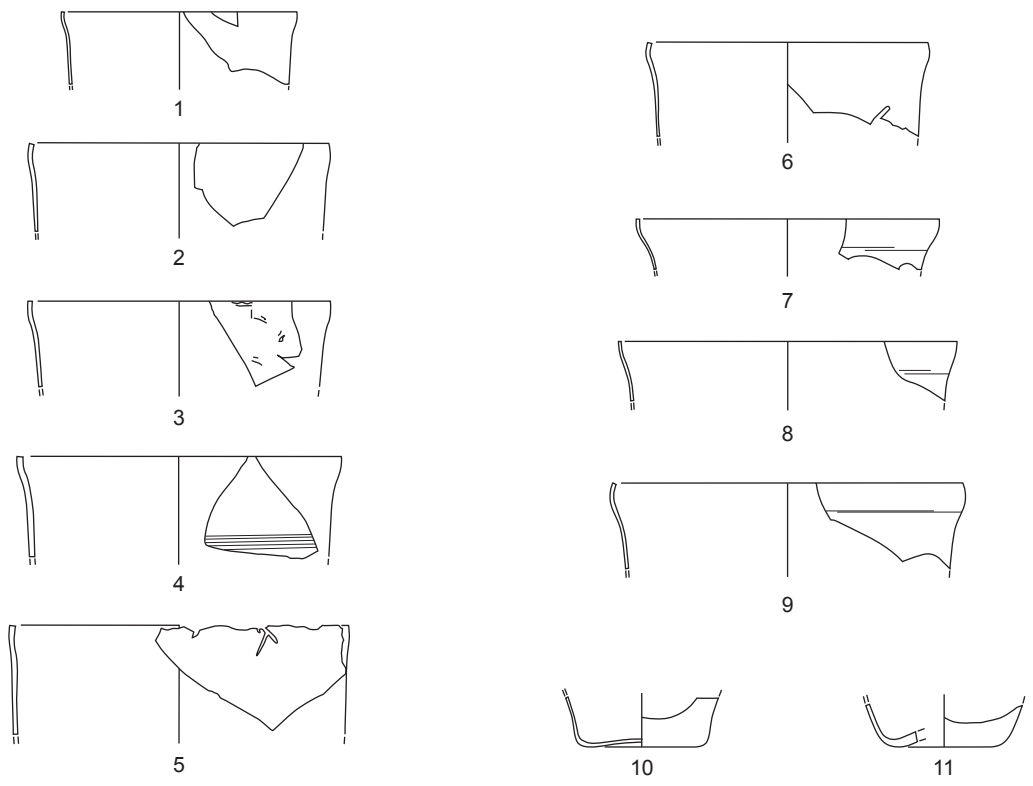

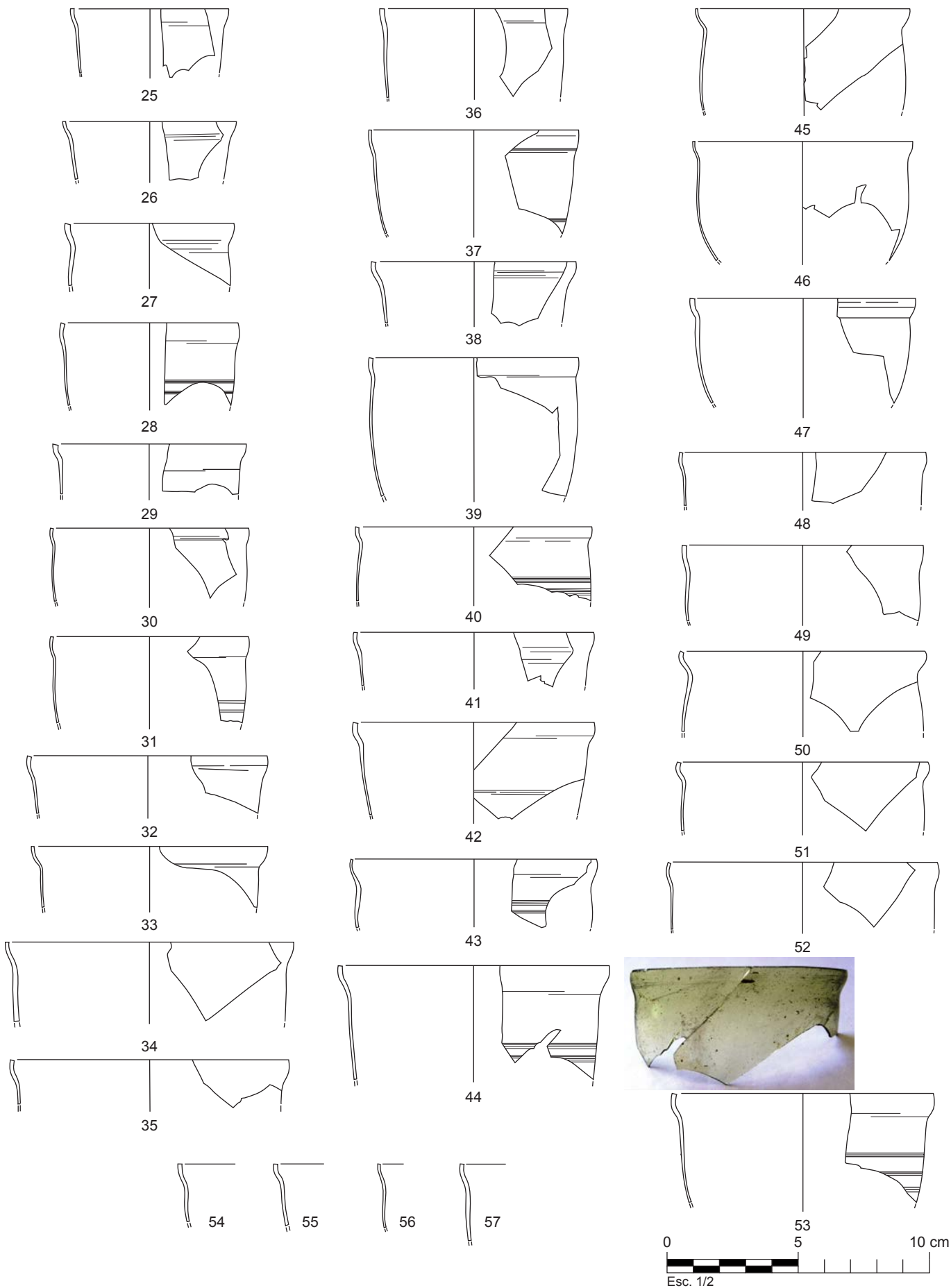

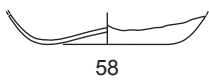

58

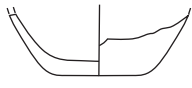

61



63

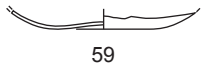

59

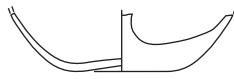

62



64

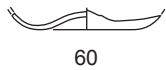

60

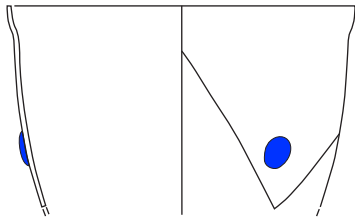

65

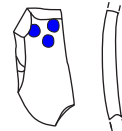

66



Fotografia extreta de STERN 2001, N°155

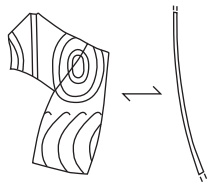

67

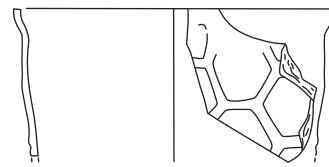

68

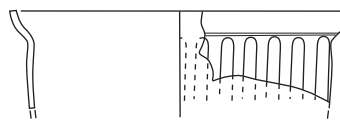

69



70

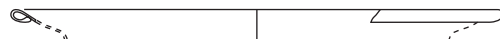

71

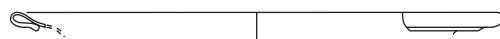

72

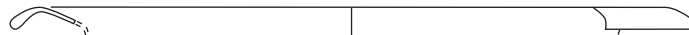

73



74

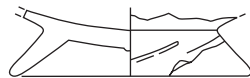

75



76

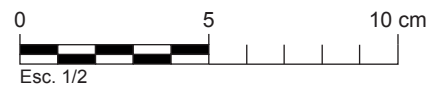

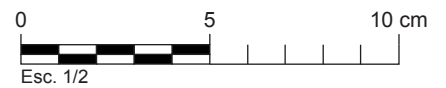
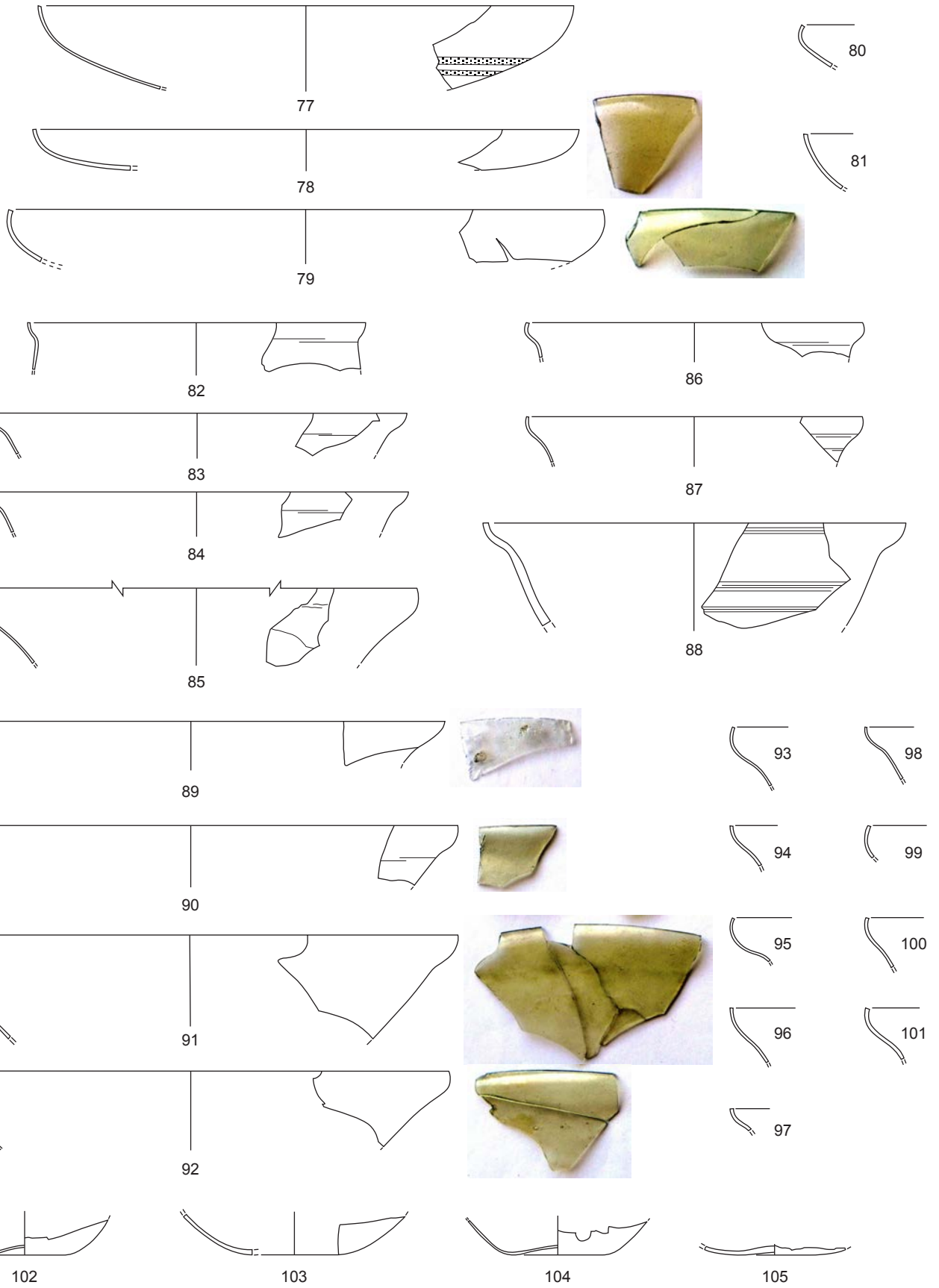

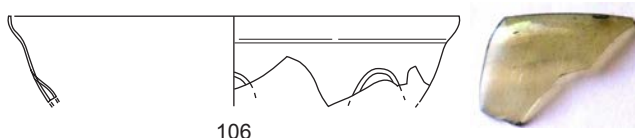

106



107

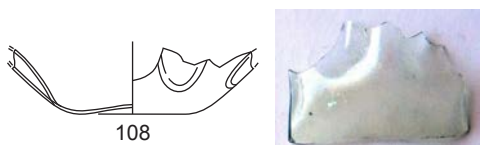

108

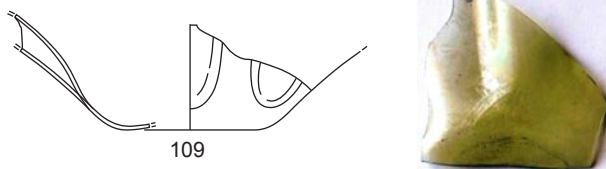

109

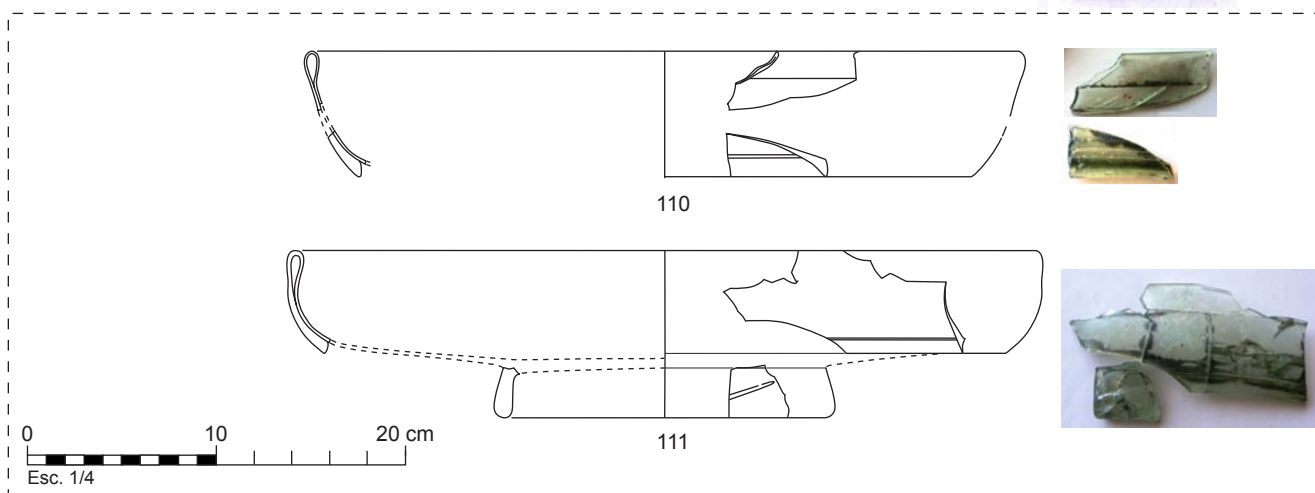

110

111

0 10 20 cm  
Esc. 1/4

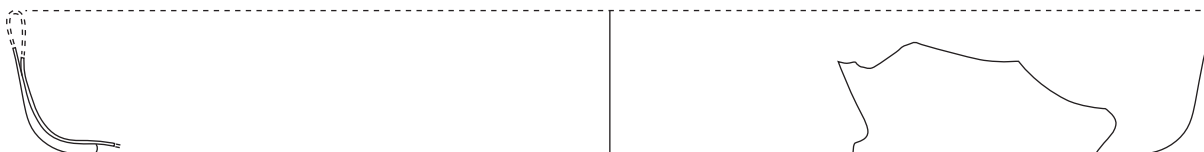

112

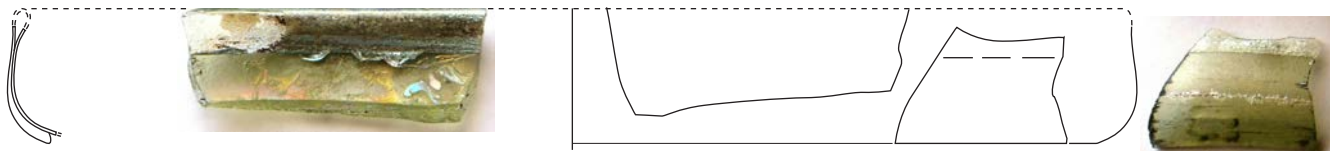

113

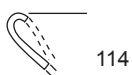

114

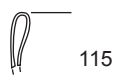

115

0 5 10 cm  
Esc. 1/2

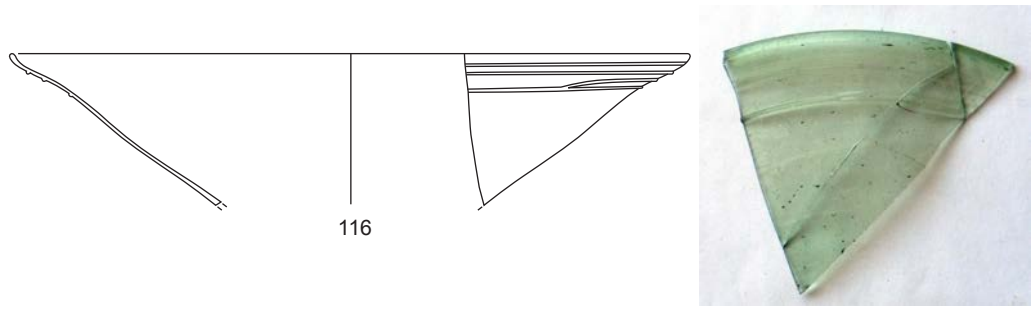

116

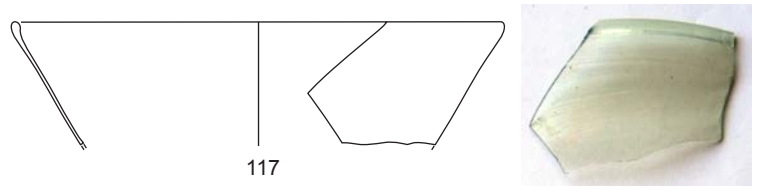

117

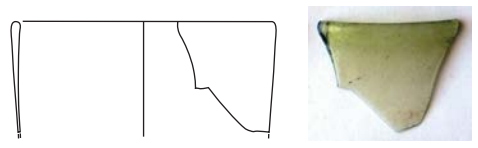

118

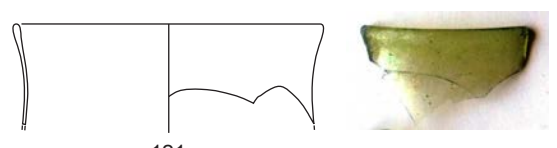

121

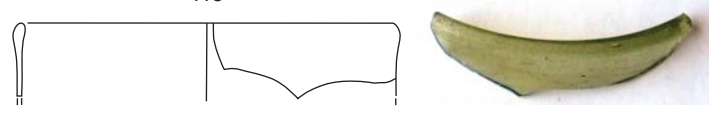

119



122

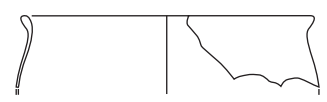

120

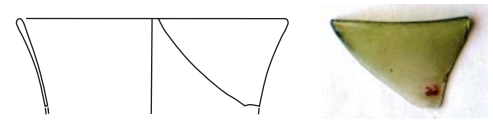

123

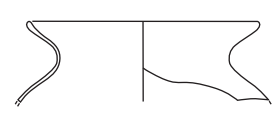

124

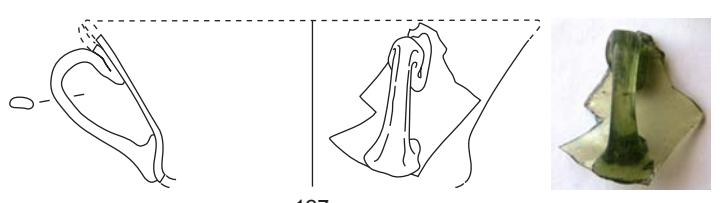

127

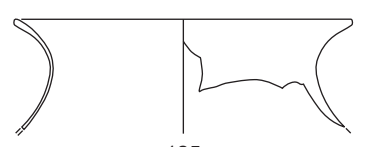

125

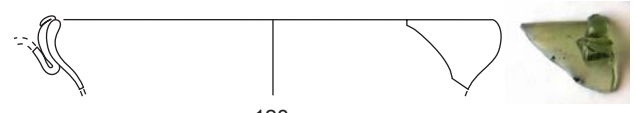

128

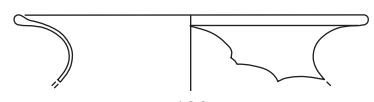

126



130



131

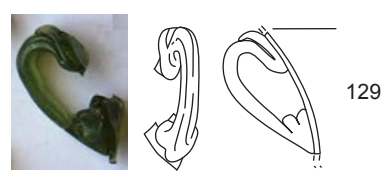

129

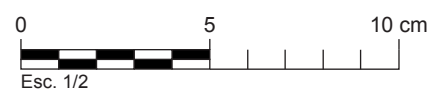



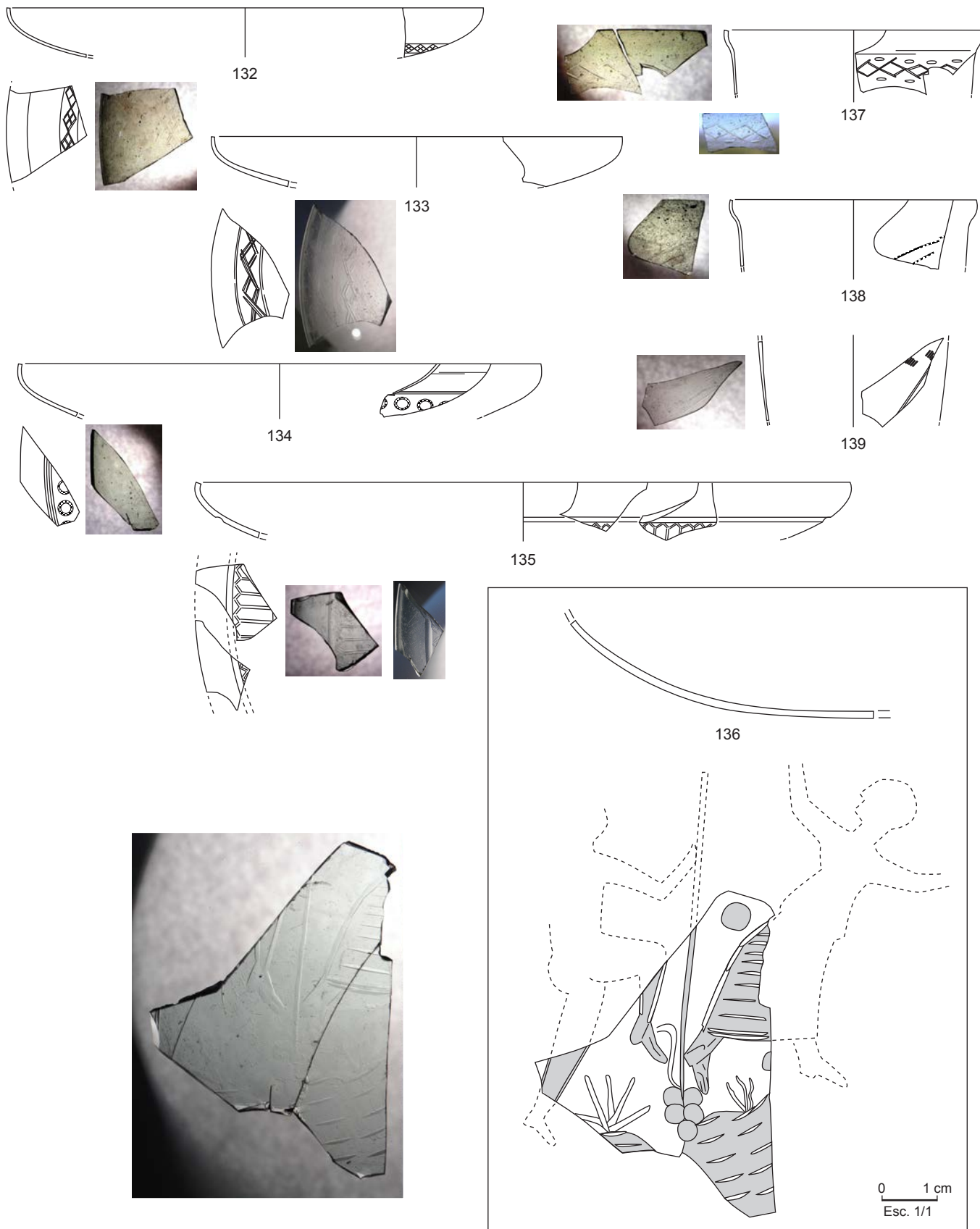

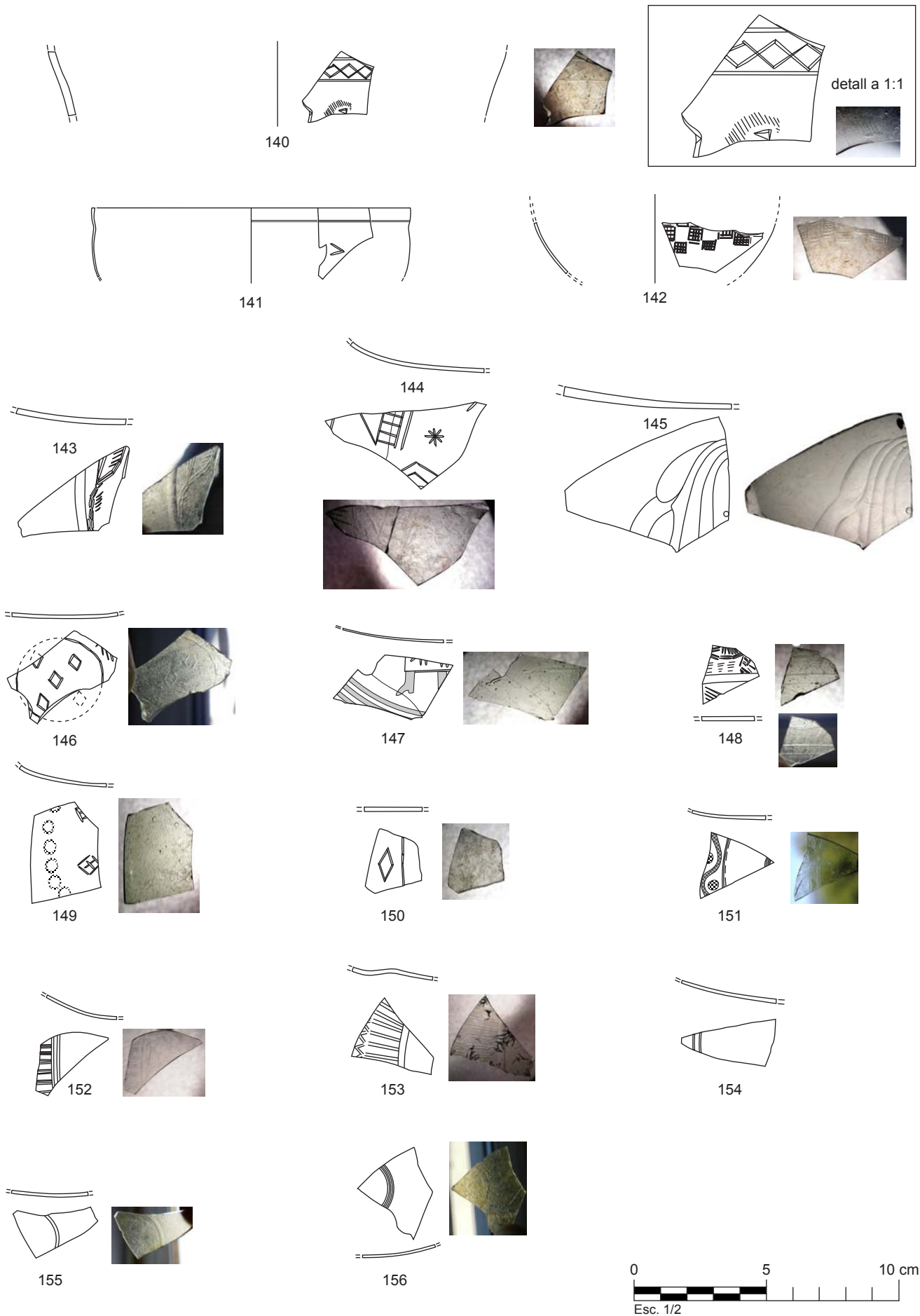

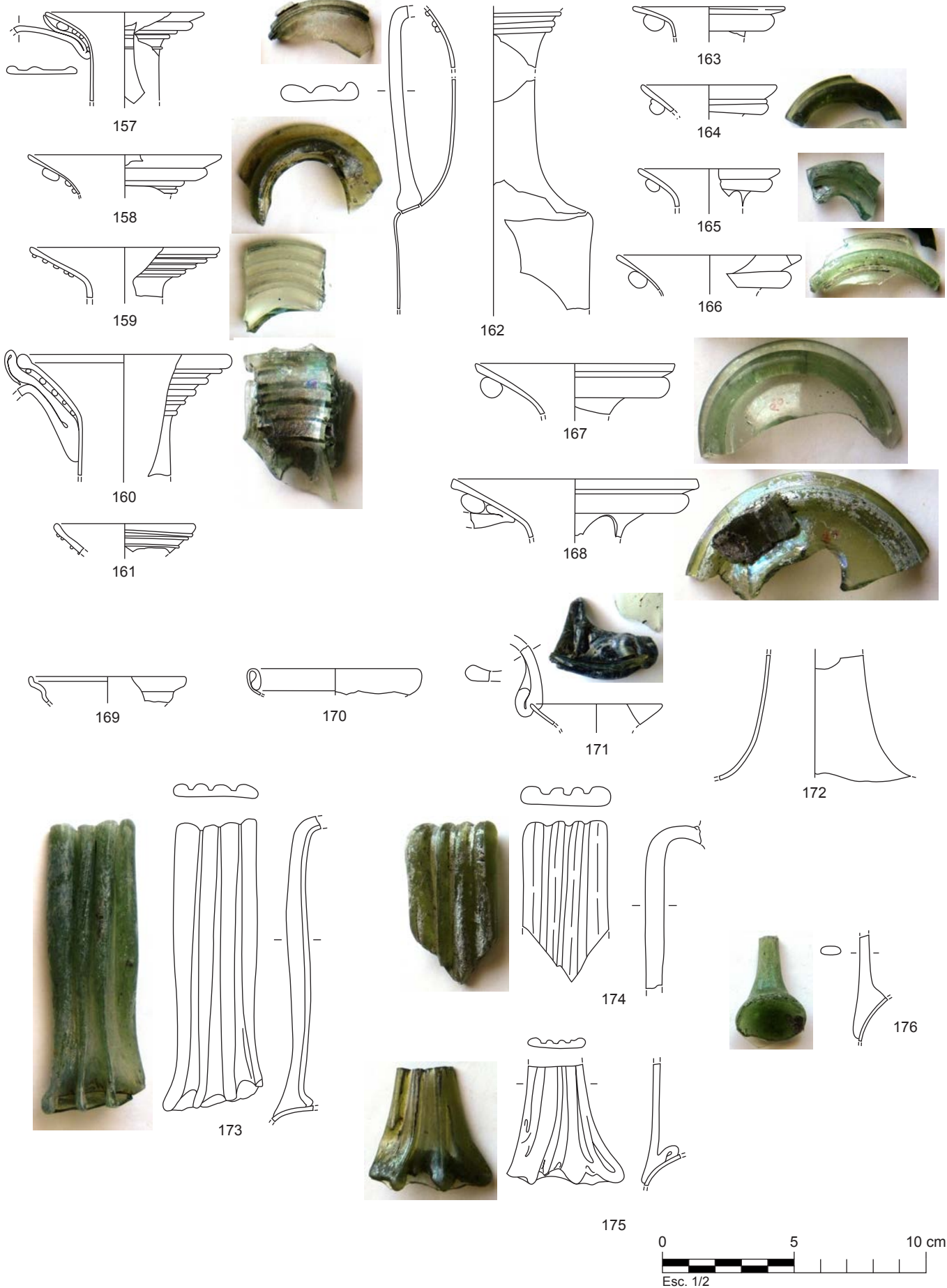

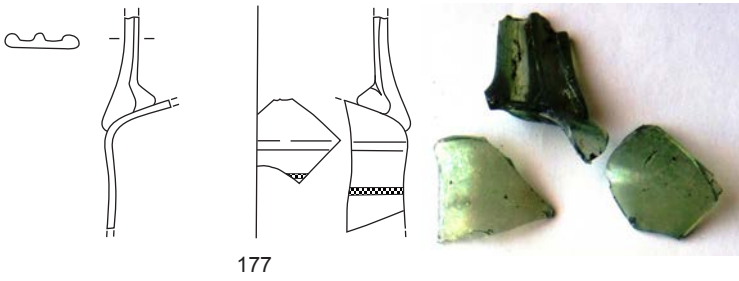

177

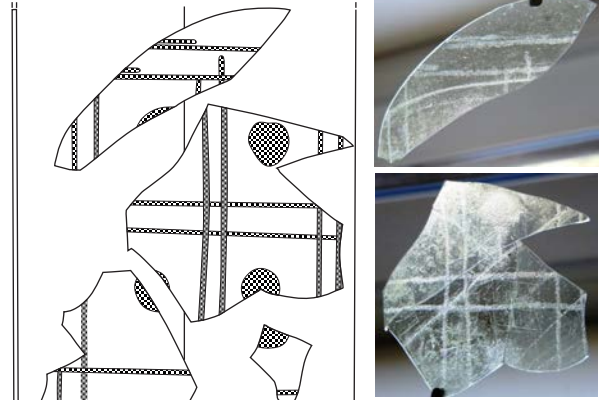

179

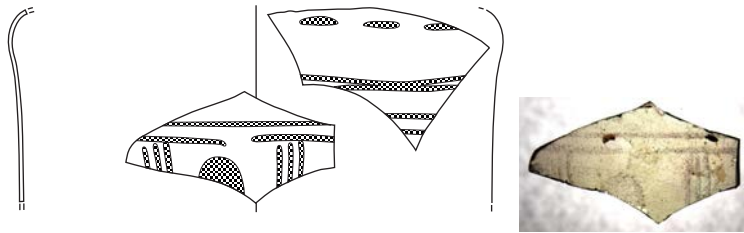

178

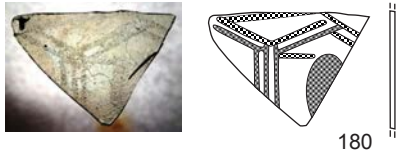

180

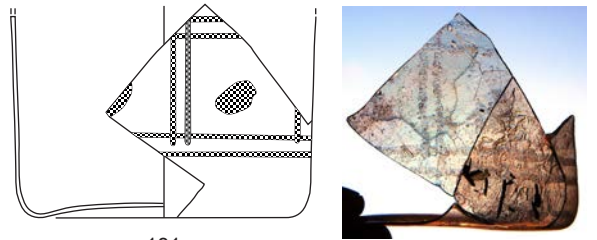

181

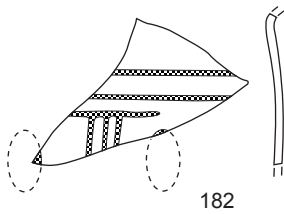
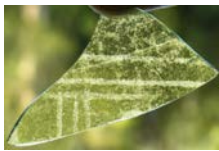

182

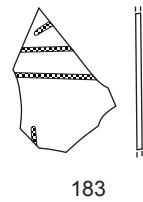

183

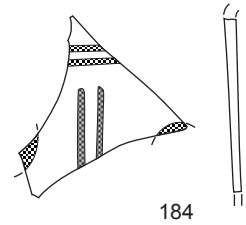

184

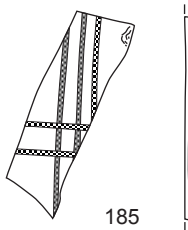

185

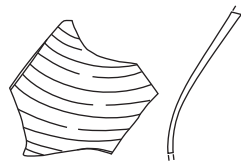
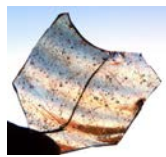

186

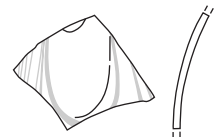

187



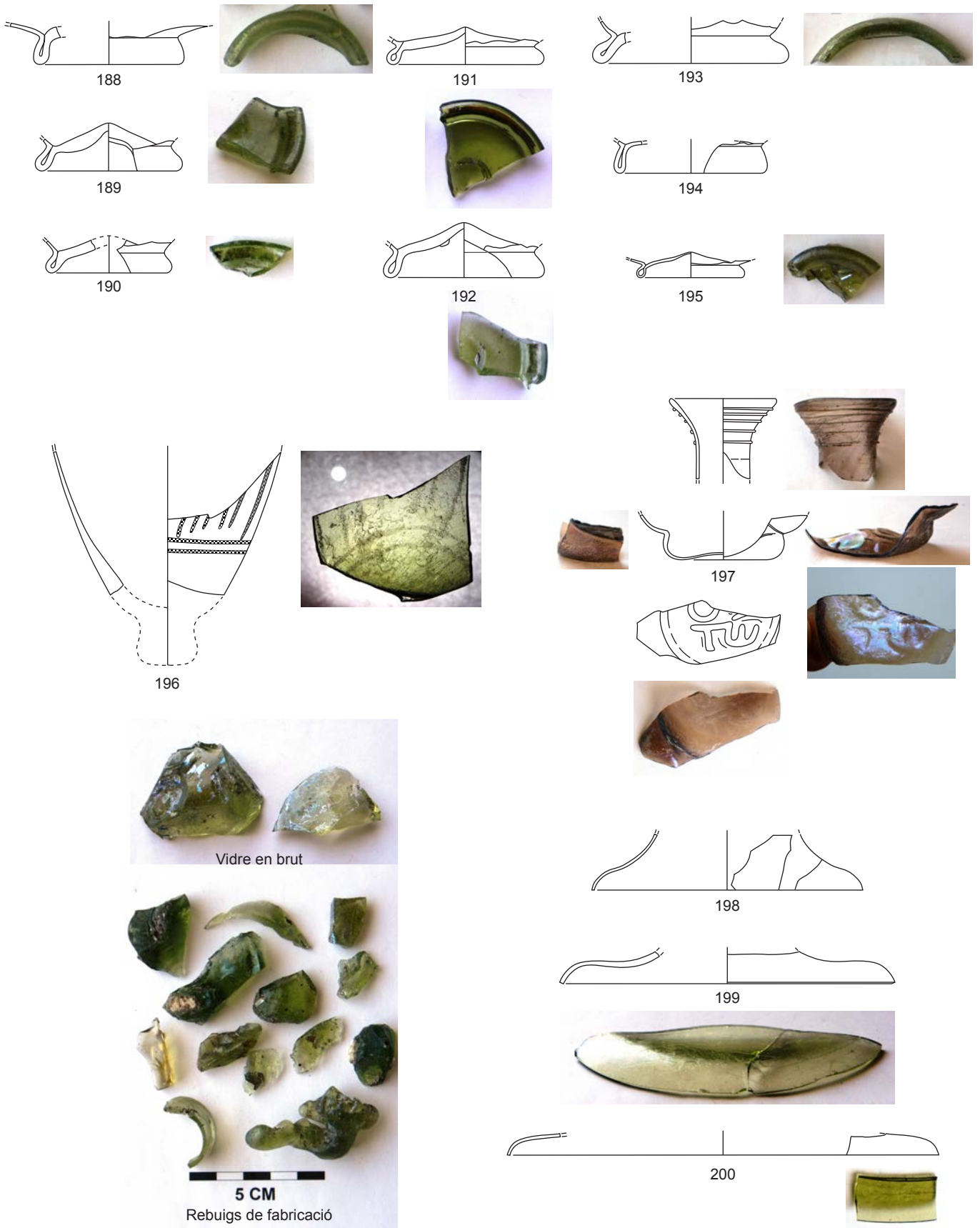

Vidre en brut

5 CM  
Rebuigs de fabricació

0 5 10 cm  
Esc. 1/2

UE.5136

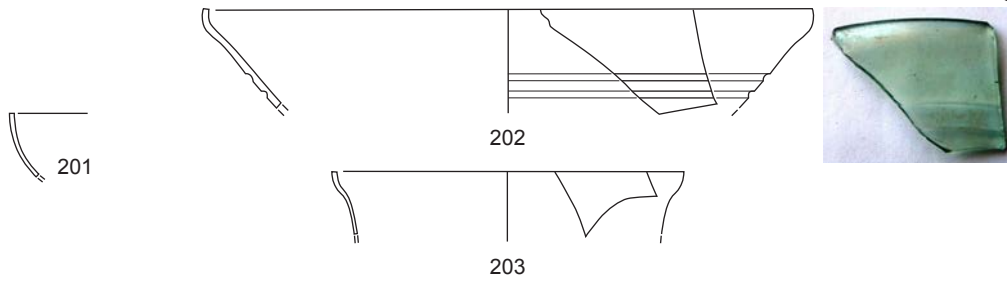

UE.5146

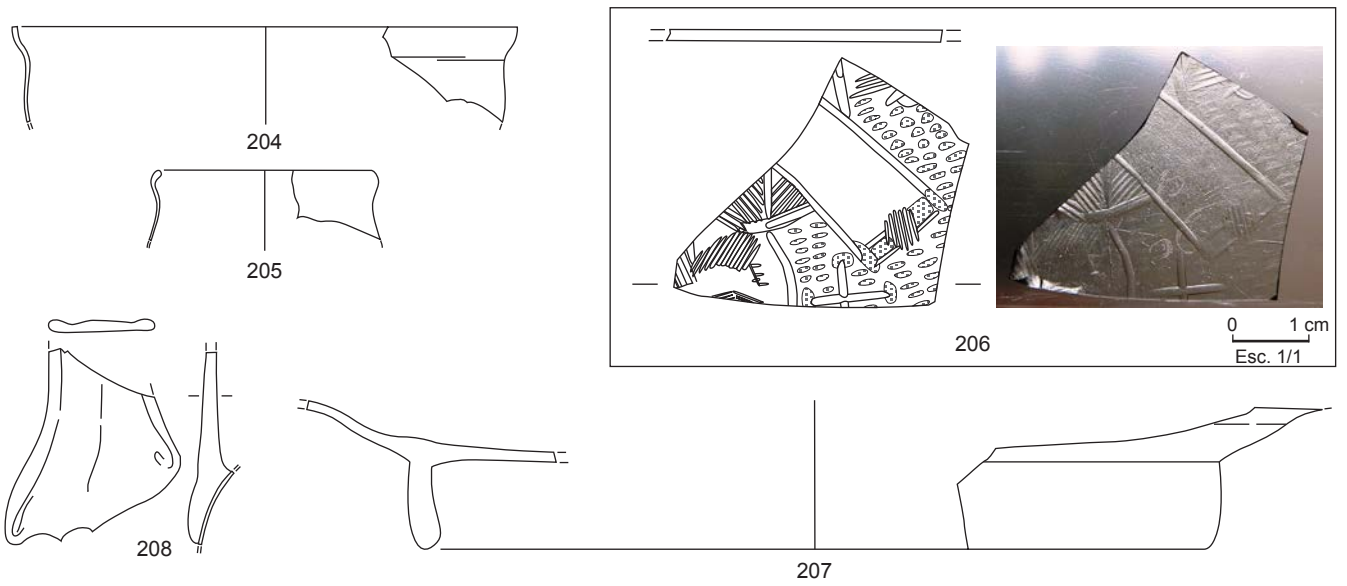

UE.5191

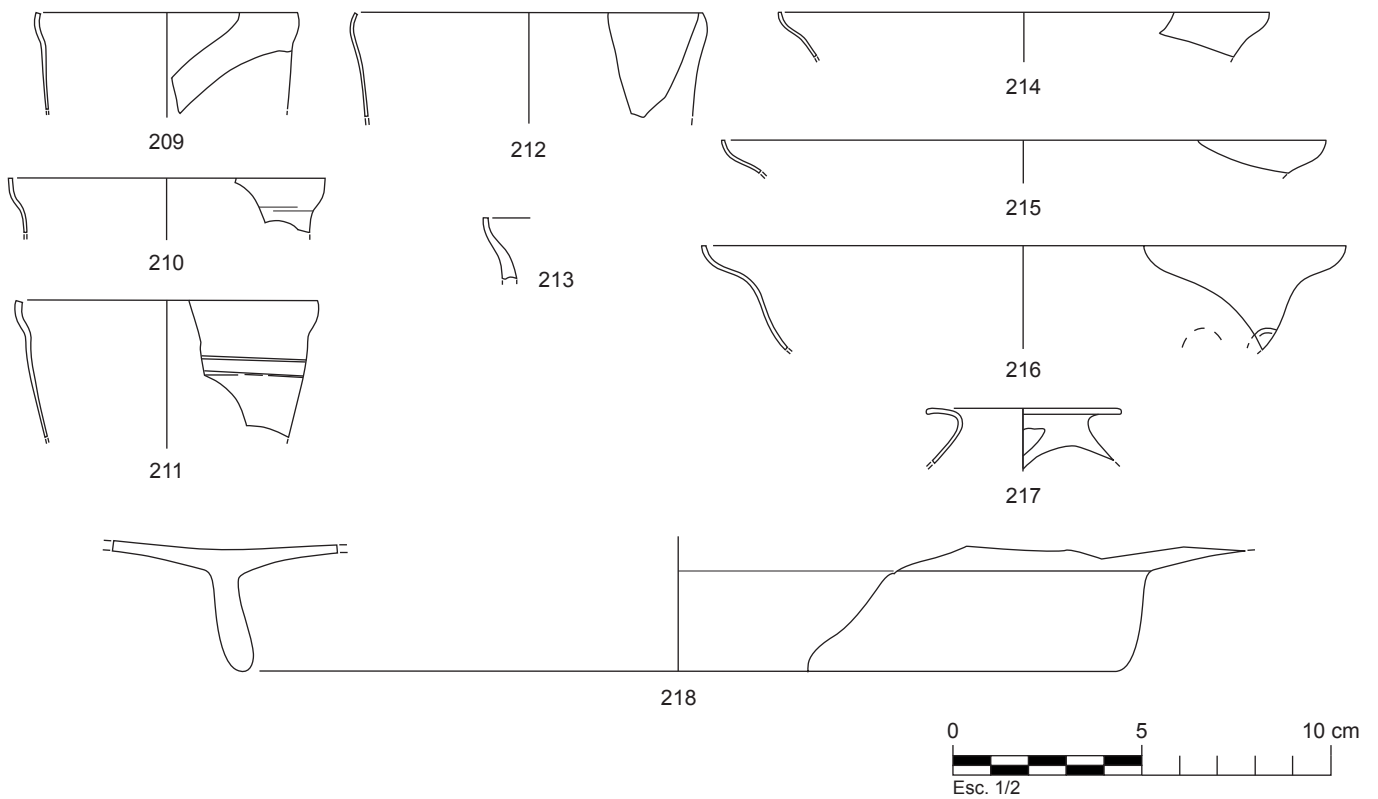

UE.5191

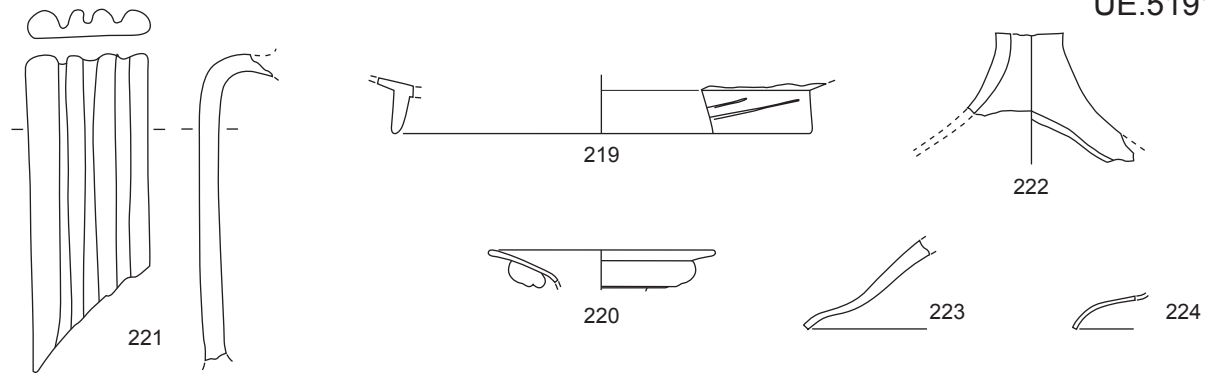

UE.5431

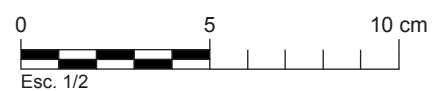
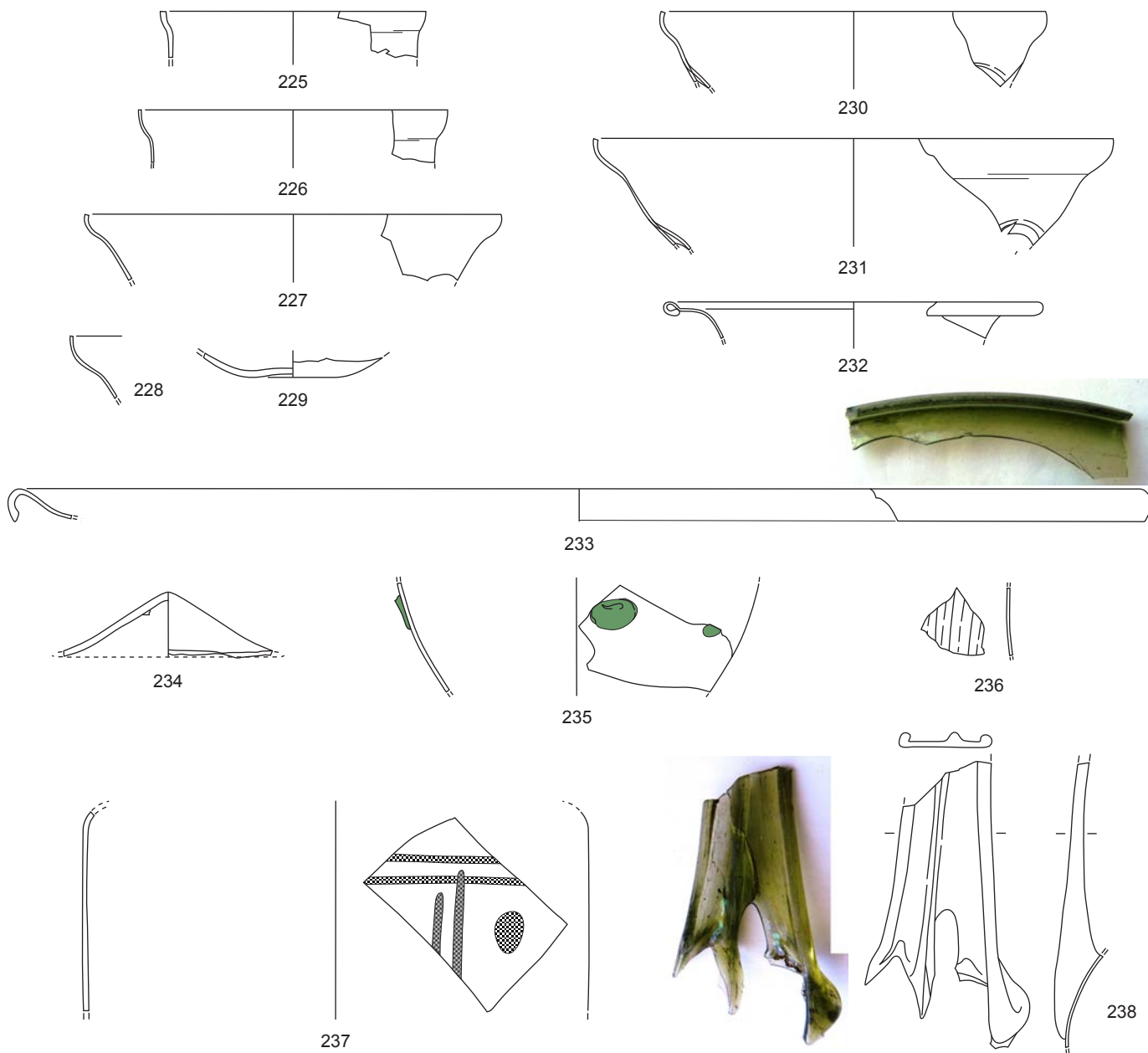

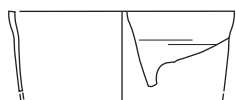

239



242

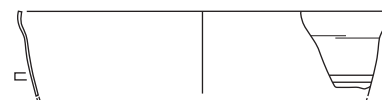

245

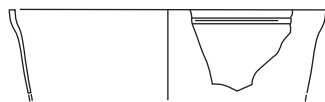

240

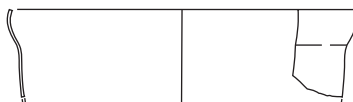

243



246

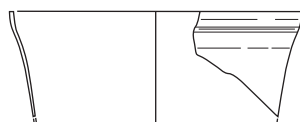

241

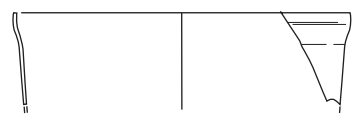

244

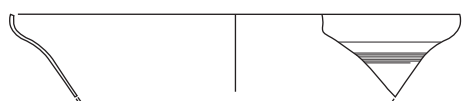

247



248



249

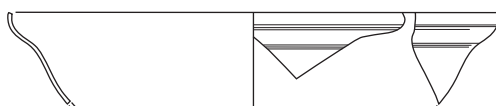

250

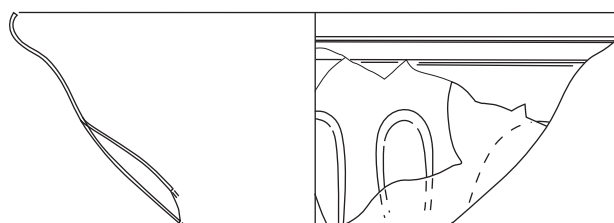

253

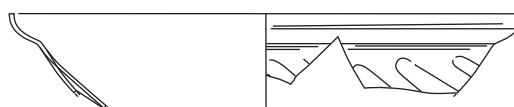

254



251



255



252

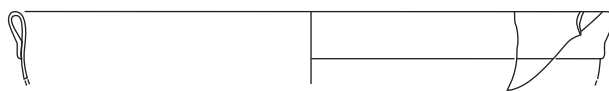

256

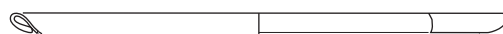

257



258

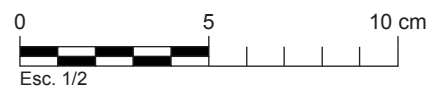



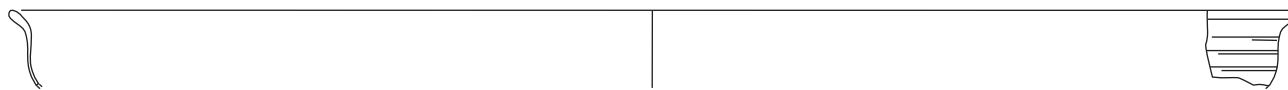

259

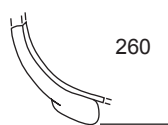

260

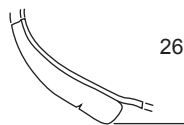

261

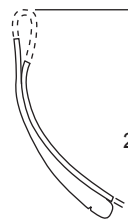

262



263



264

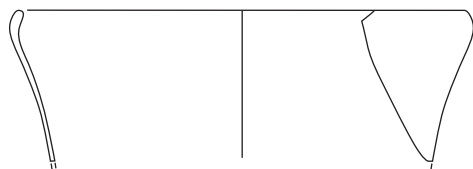

265

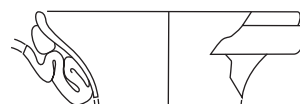

267

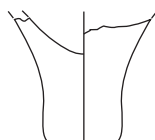

266

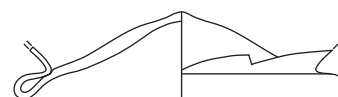

268



269

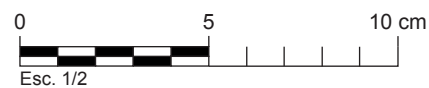
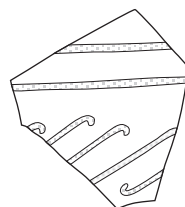

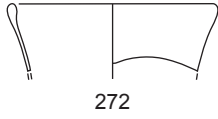
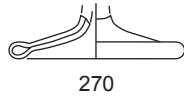

272

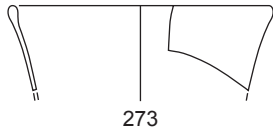

273

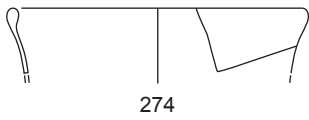

274



275



278



279

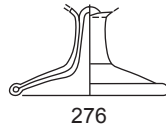

276

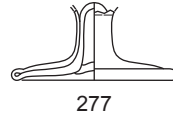

277

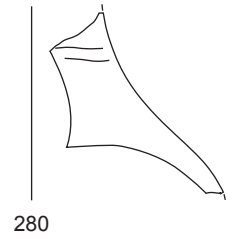

280



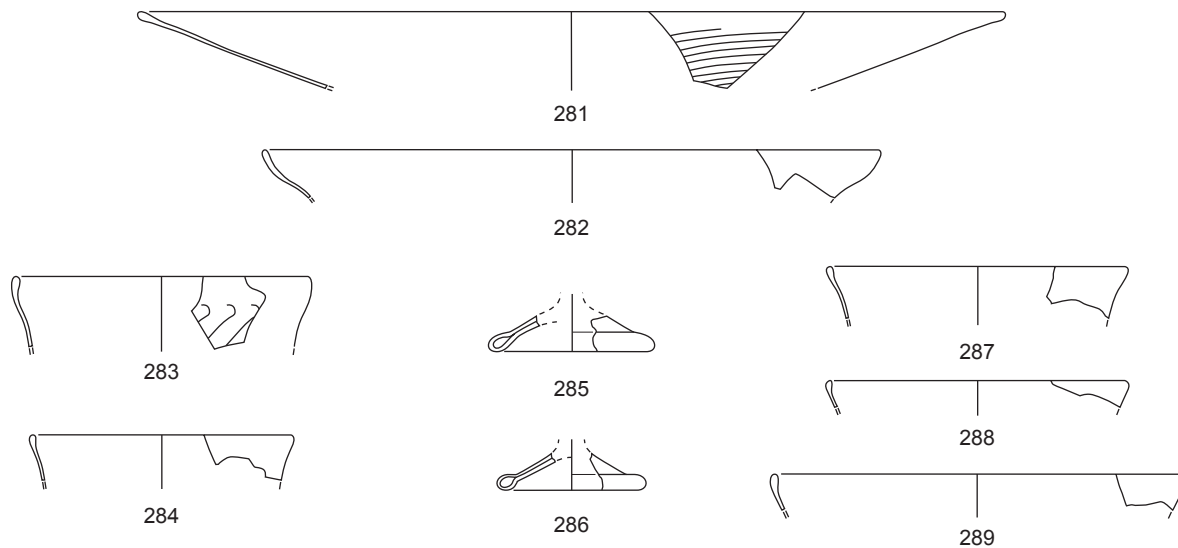

UE.5287

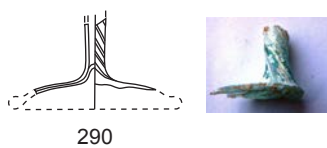

UE.5288

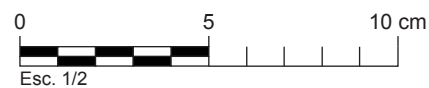
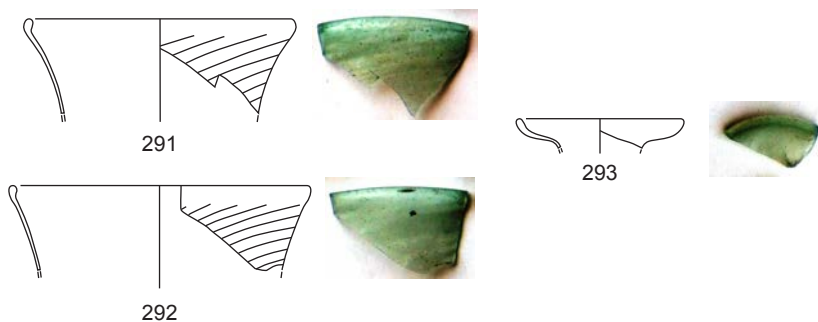

UE.5004

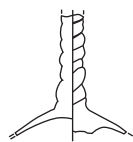

294



UE.5007

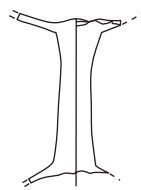

295



UE.5009

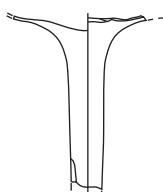

296



UE.5124

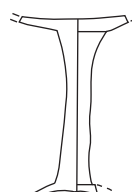

297



UE.5114

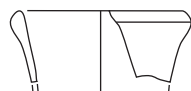

298

UE.5417

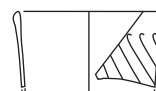

299

UE.58003

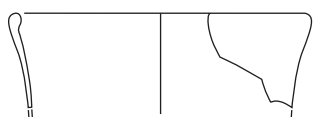

300

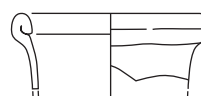

301



302

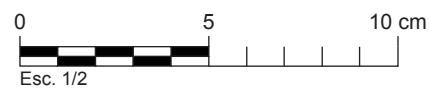
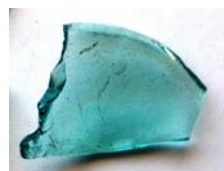

UE.1003

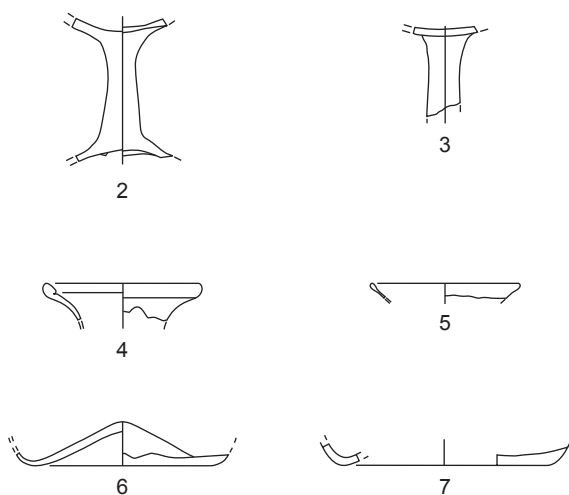
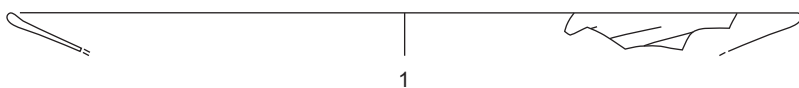

UE.1020

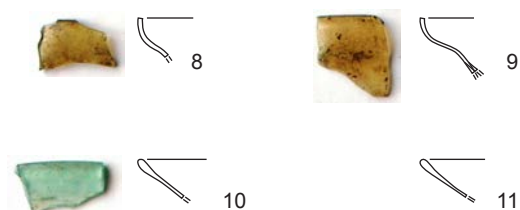

Fragments i esclats de nuclis de vidre en brut

UE.1028

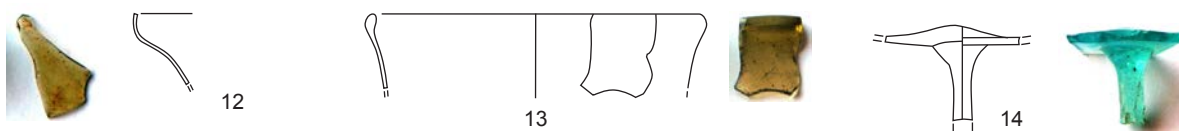

UE.1030

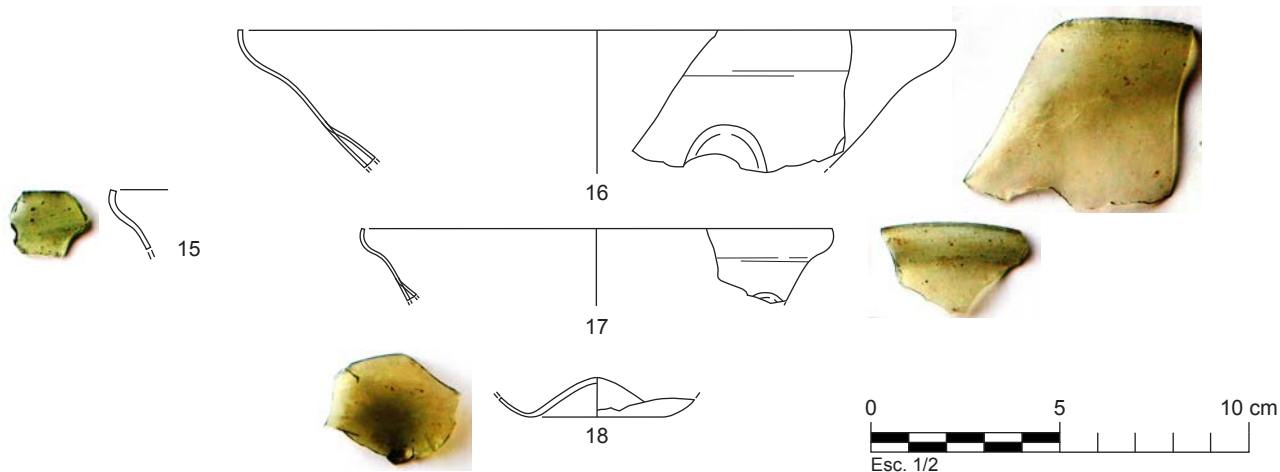

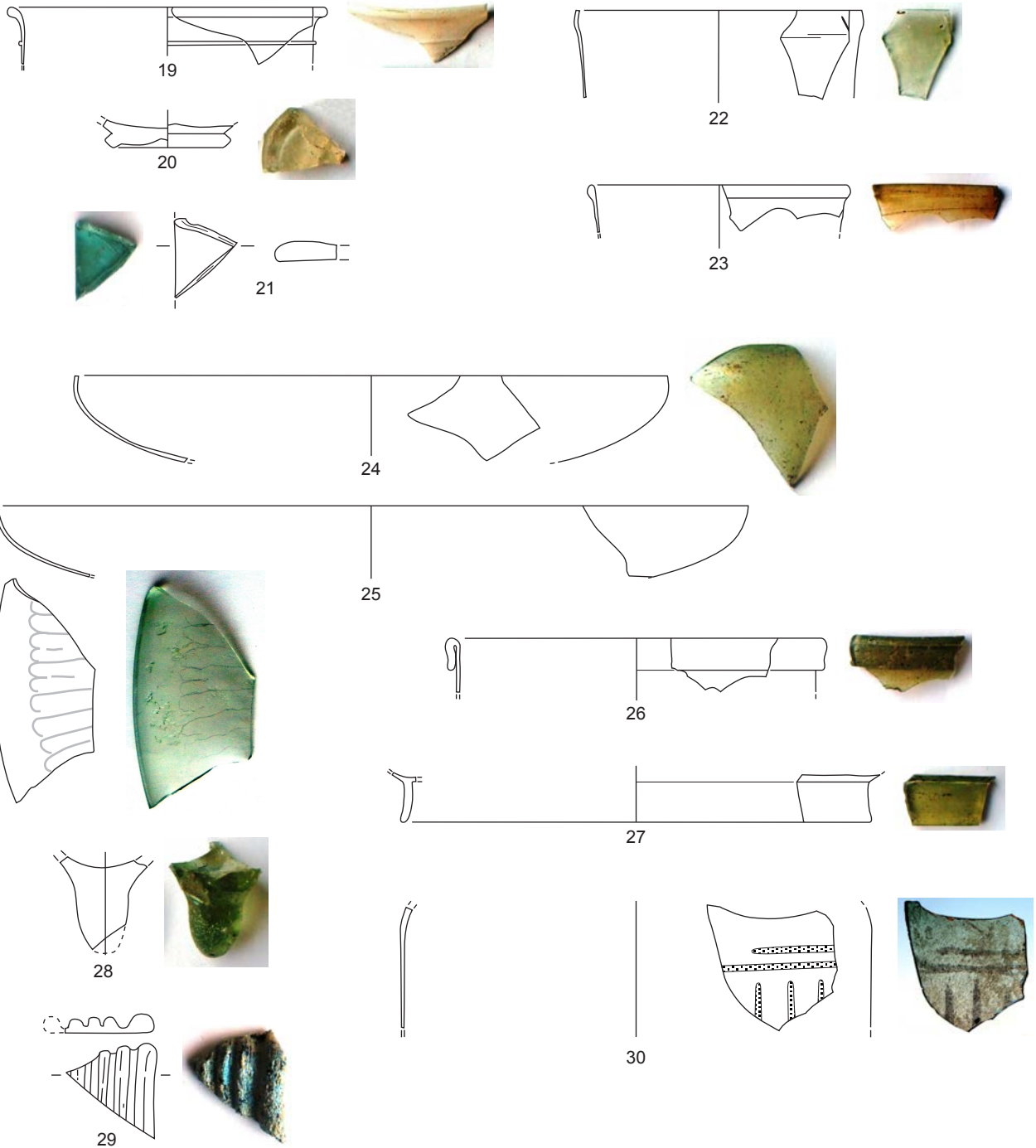

Fragments i esclats de nucli de vidre en brut

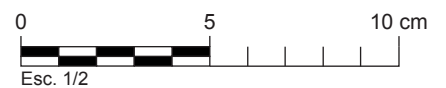
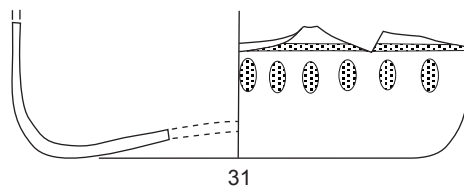

UE.1041

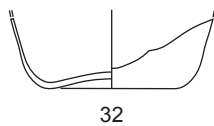

32



33



UE.1048

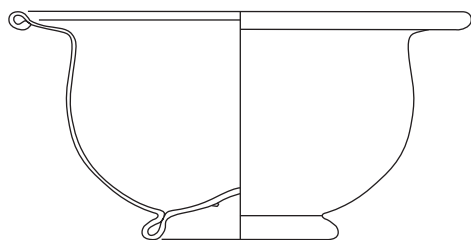

34

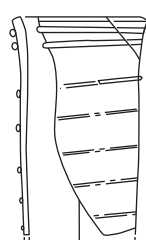

35

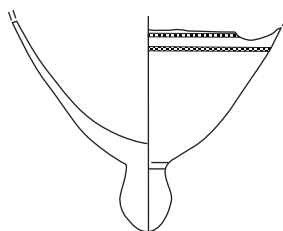

36



37

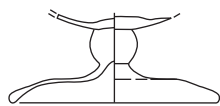

38

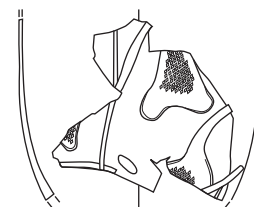

39



UE.1049

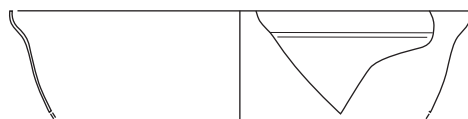

40



UE.1054



41

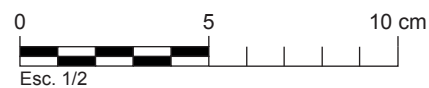

Esc. 1/2

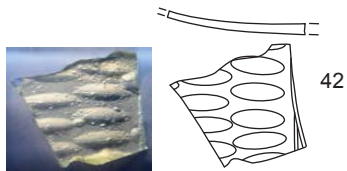

42

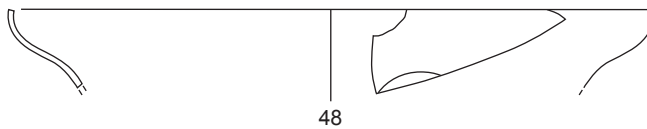

48



49

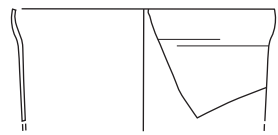

43

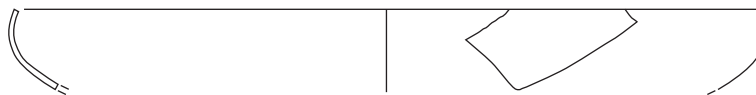

50



44



47



51

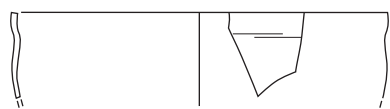

45

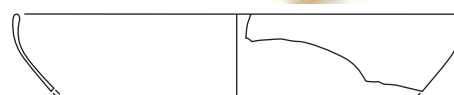

52



46

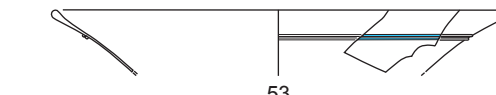

53



54

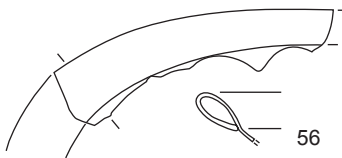

56

55

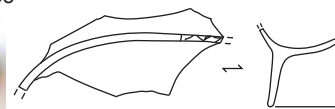

58



57



59

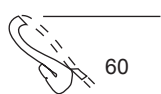

60

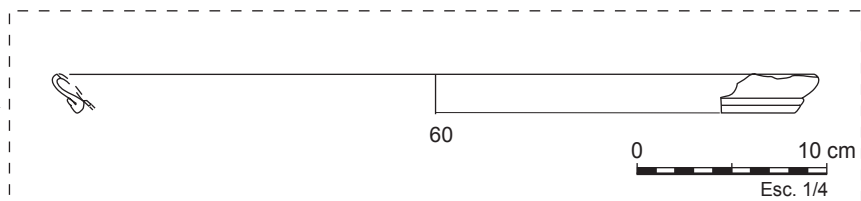

60



Esc. 1/4

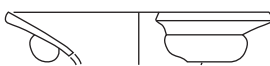

61

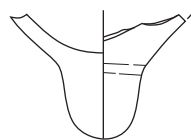

63

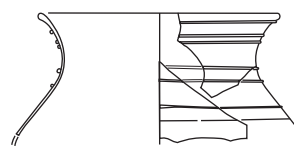

64

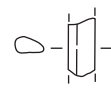

65



62

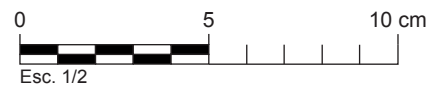

Esc. 1/2



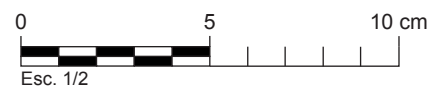
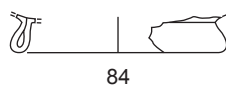
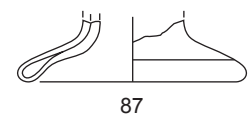
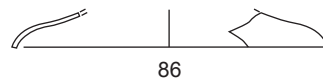
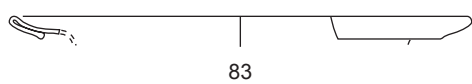
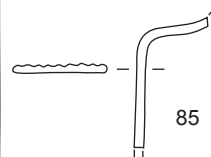
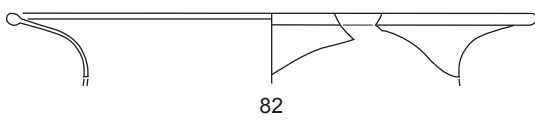
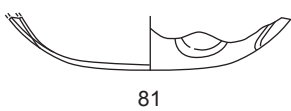
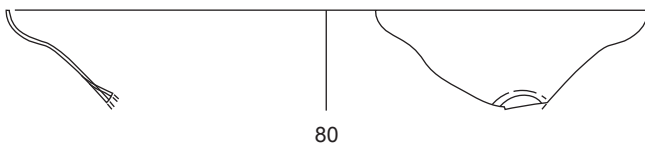
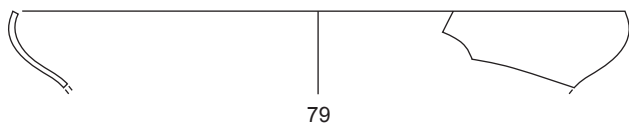
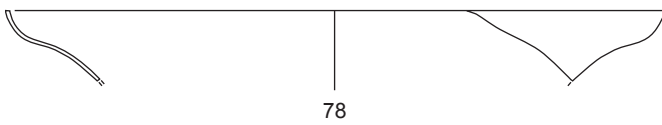
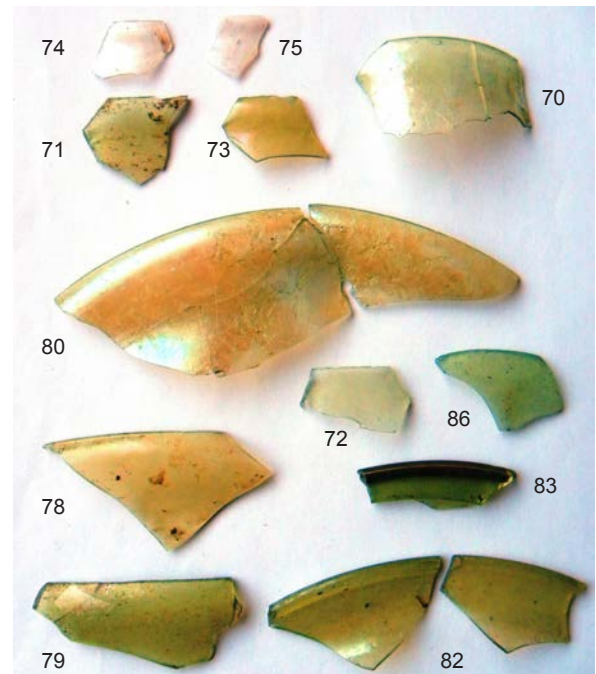
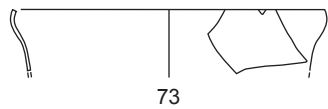
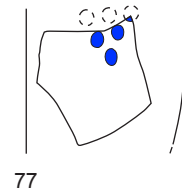
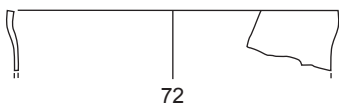
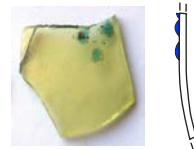
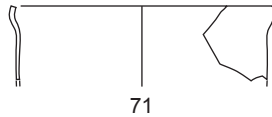
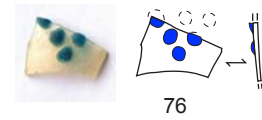
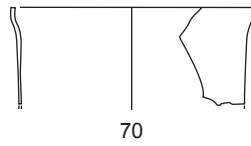
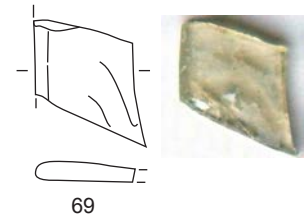
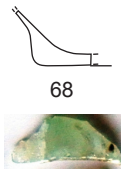
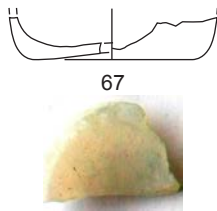

UE.1069

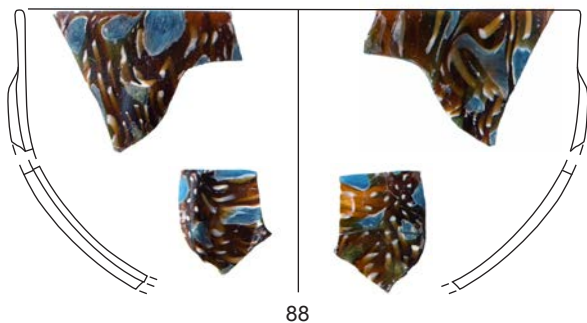

88

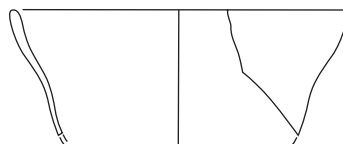

89

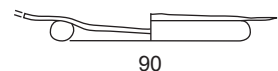

90



91



92

UE.1076

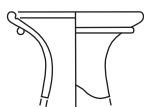

93

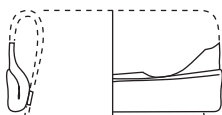

94

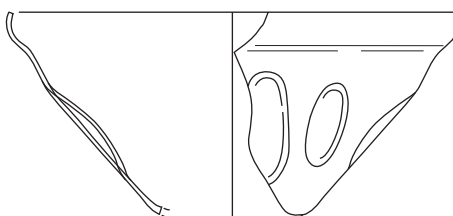

95

UE.1102



UE.1133



97



UE.1134



96



UE.1179

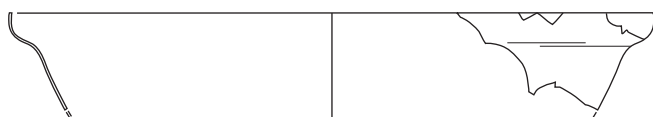

98

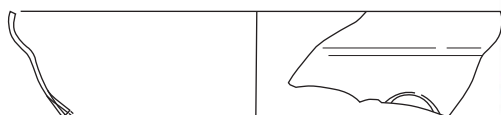

99



100



101



102

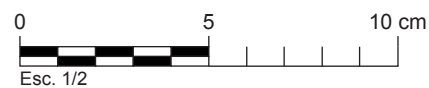

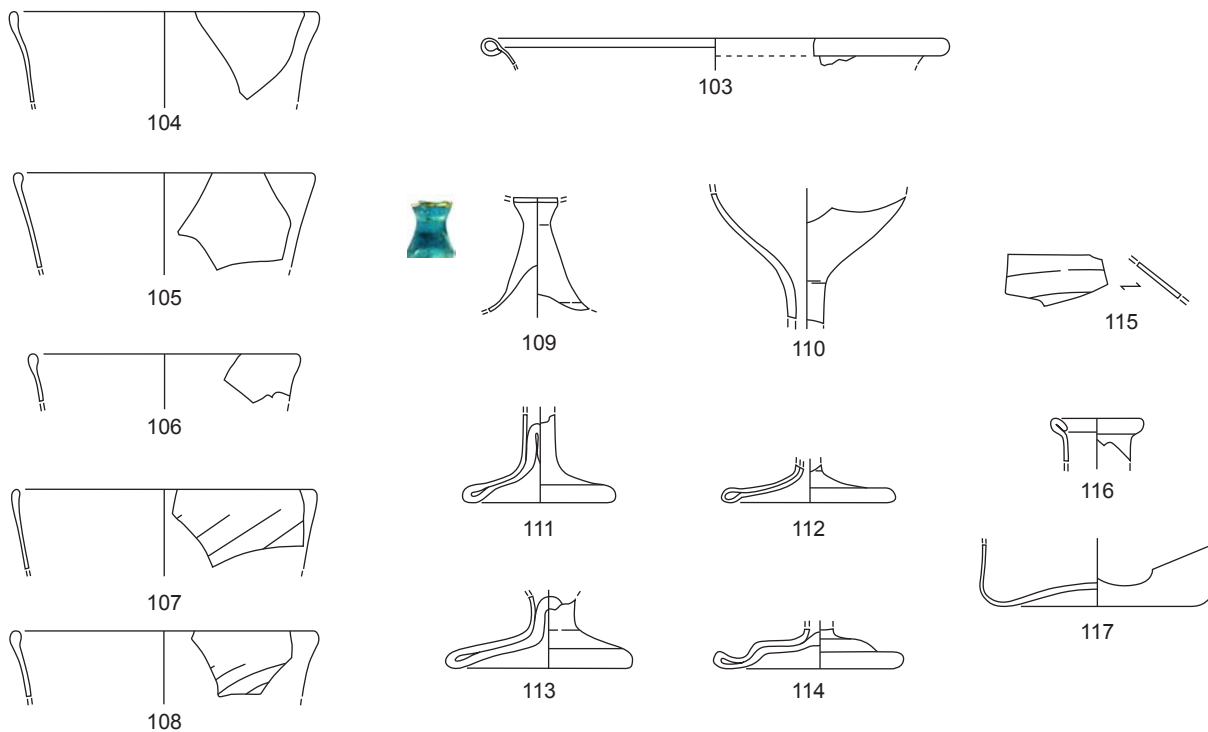

Fragments i esclats de nucli de vidre en brut

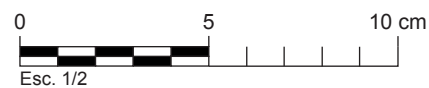

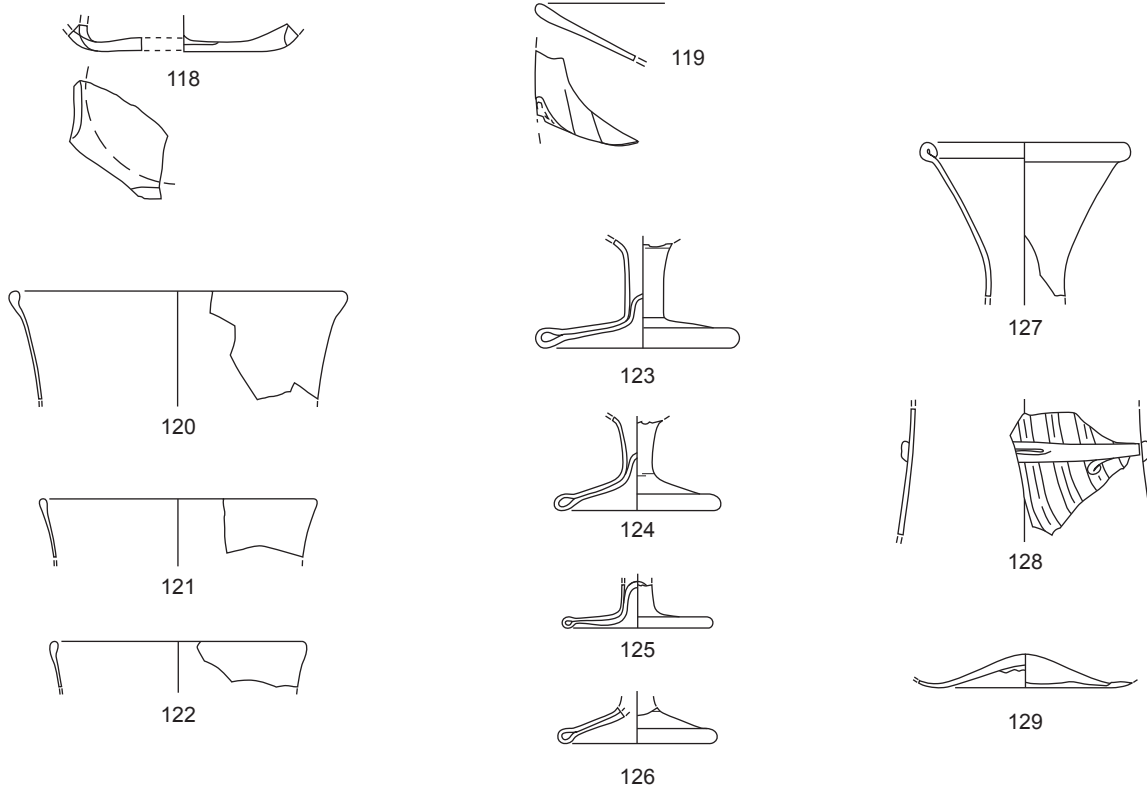

Fragments i esclats de nuclis de vidre en brut

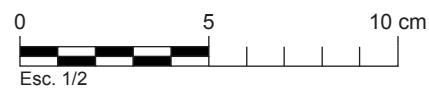

UE.2013

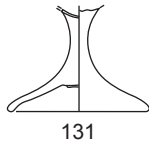
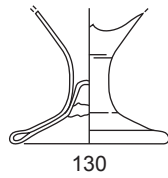

UE.2015

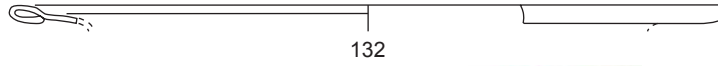

132

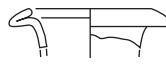

133



UE.3009



134

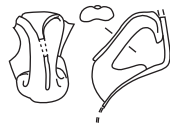

136



137

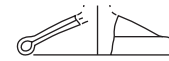

138

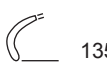

135

UE.3012

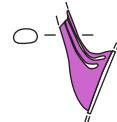

139

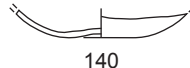

140

UE.3020



141

UE.3024



142



143

UE.3030

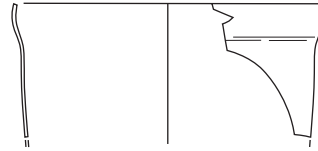

144

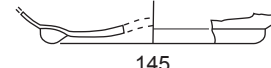
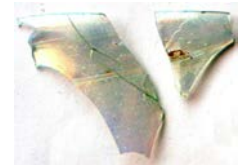

145



UE.3031



146

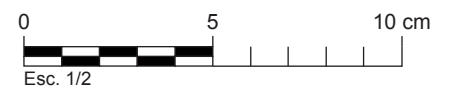

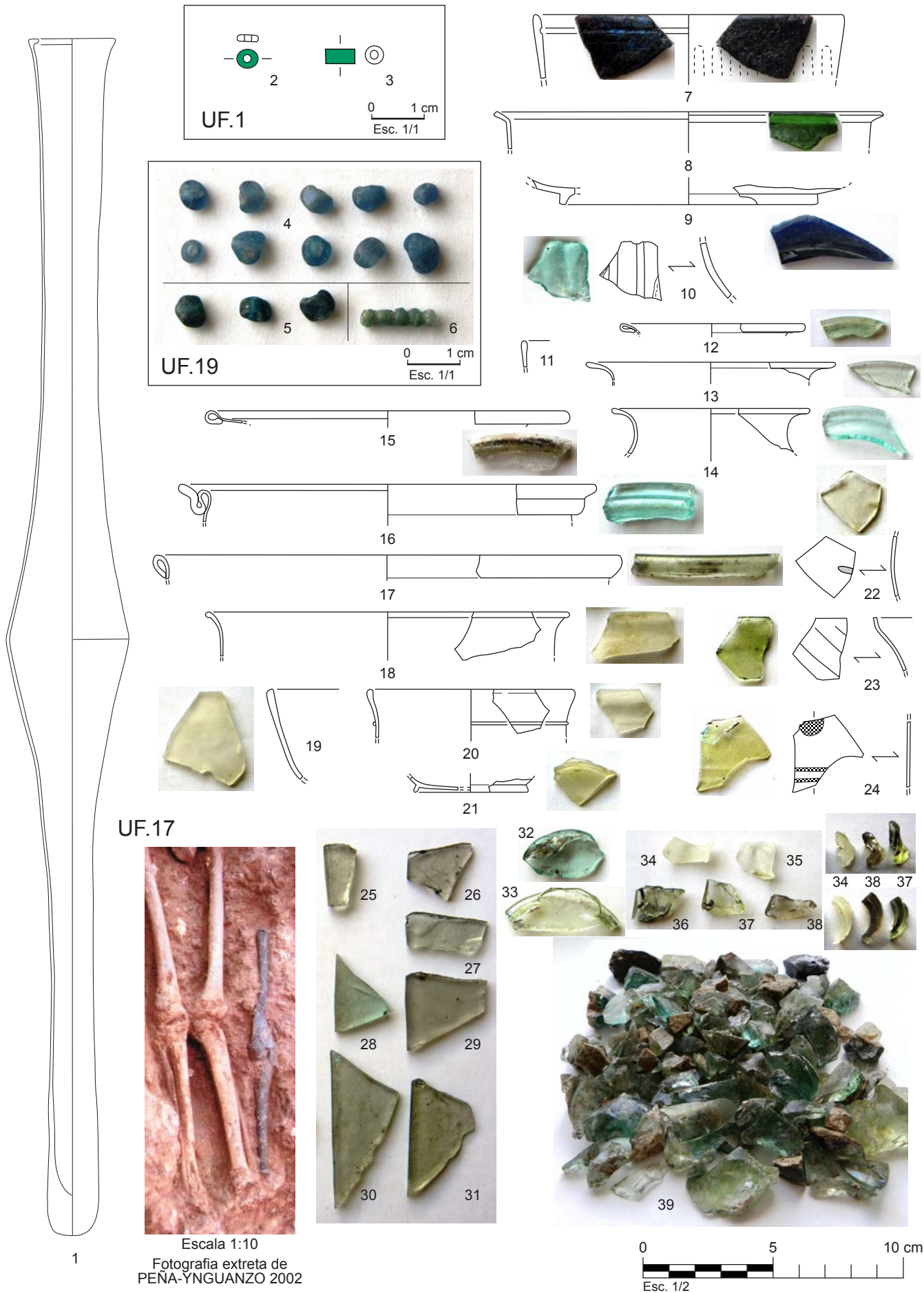

UF.1

UF.19

UF.17

Escala 1:10  
 Fotografia extreta de  
 PEÑA-YNGUANZO 2002

0 5 10 cm  
 Esc. 1/2

Parc de la ciutat 1987

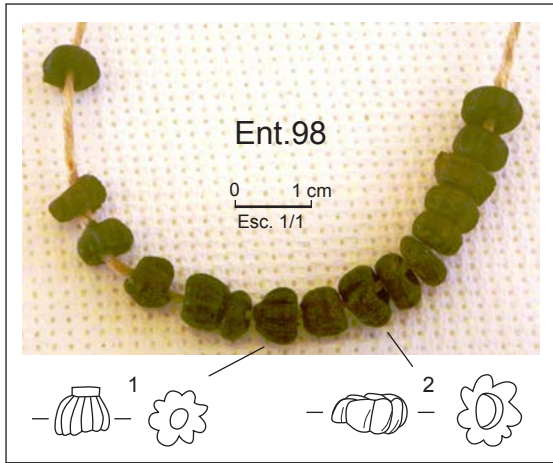

Mas Mallol - Mas Rimbau 1991

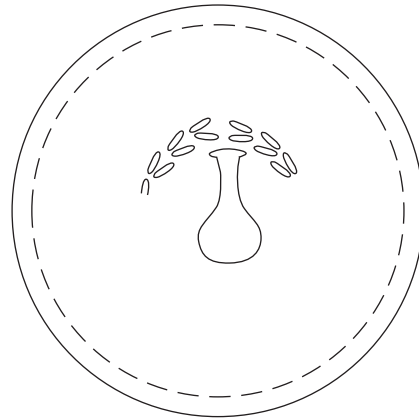
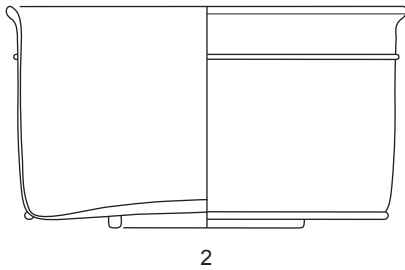
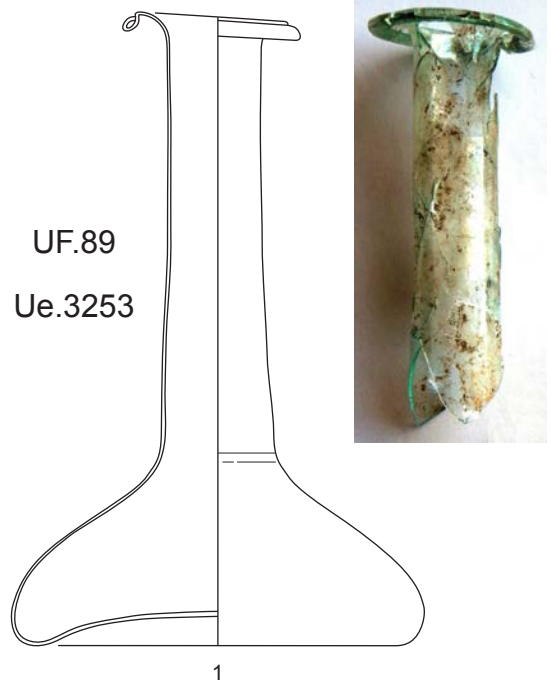

Mas Mallol - Mas Rimbau 1997



La Llosa (Cambrils)

Unitat Funerària 3

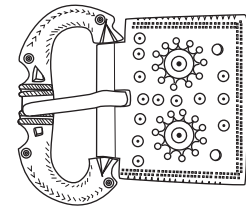
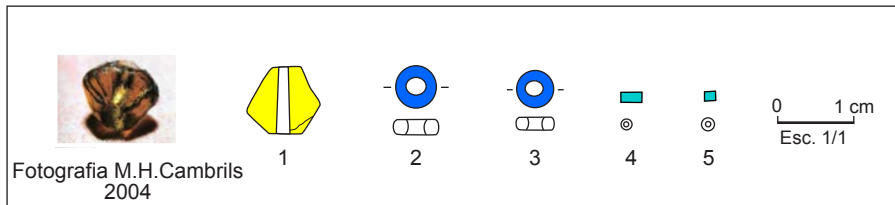

Sivella de bronze delphiniforme

Torre Bargallona (Cambrils)

UE.1

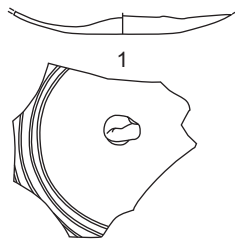

UE.51

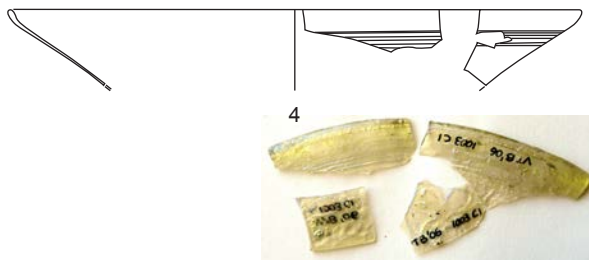
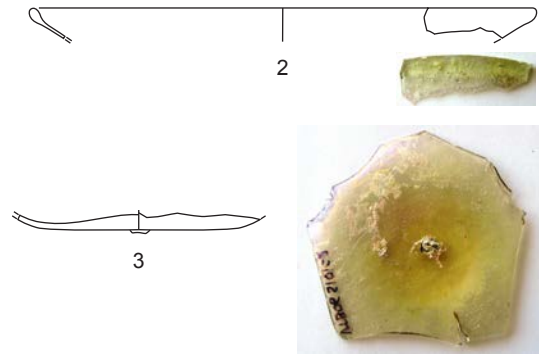

UE.1003

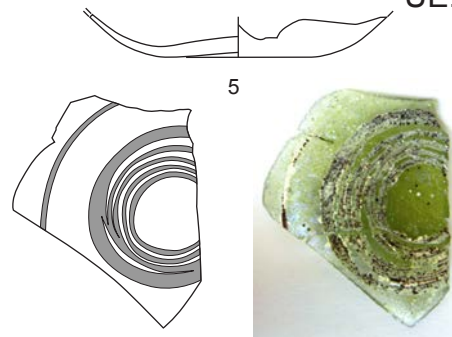

Roques de la Vilavella (Riudecols)

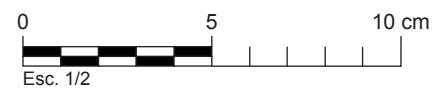
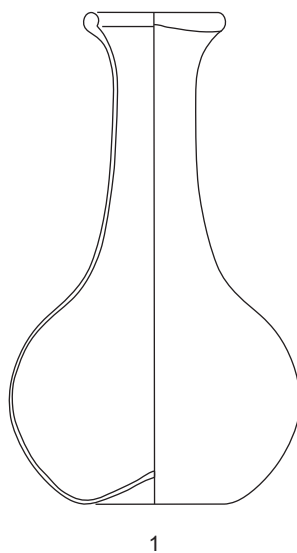



UE.2118

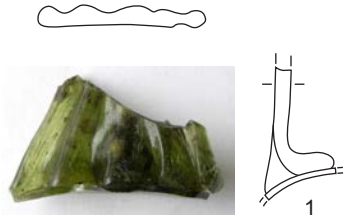

UE.2250

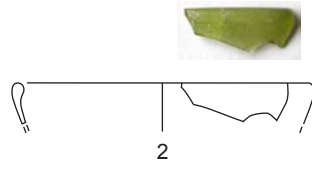

UE.2314

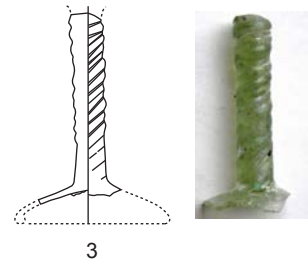

UE.3105

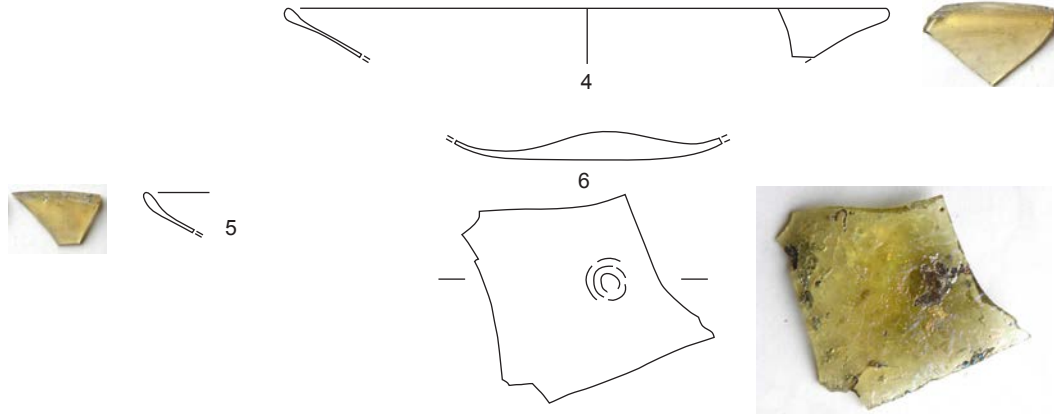

UE.3112

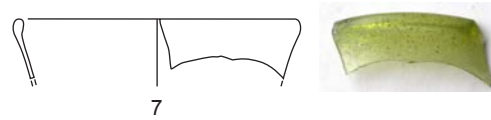

UE.3150

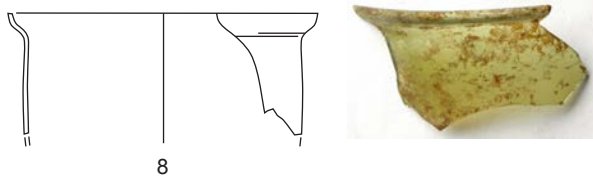

UE.3188

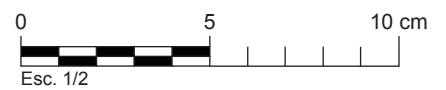
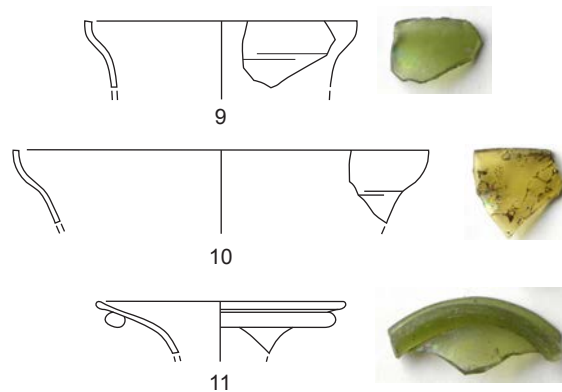

UE.3202

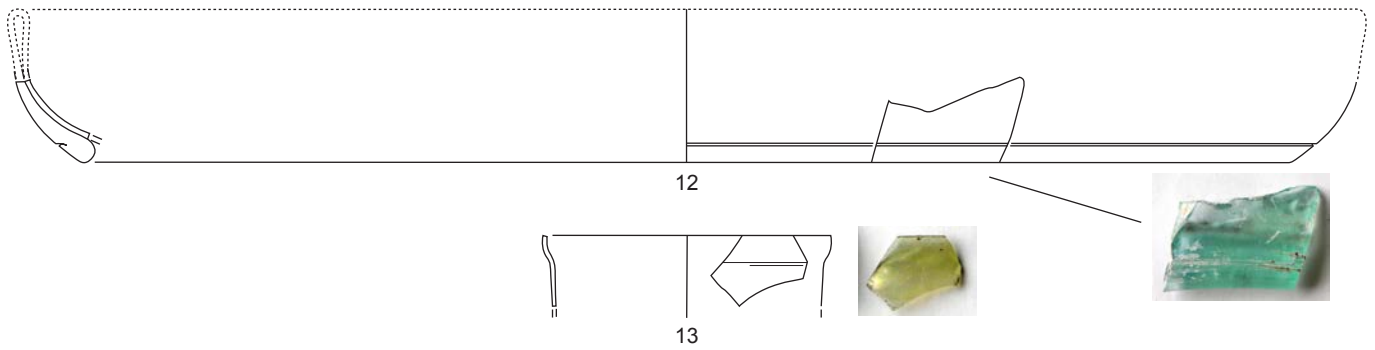

UE.3225

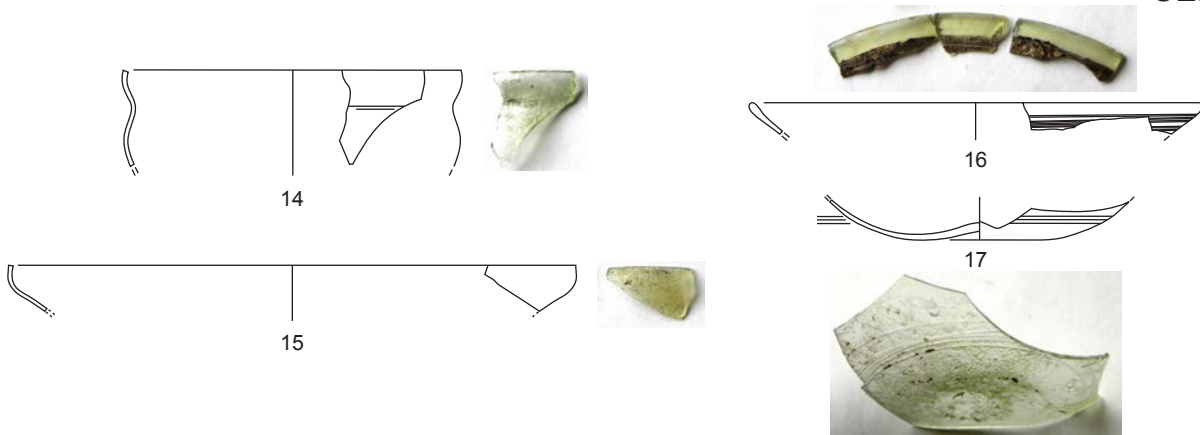

UE.3327



UE.3367

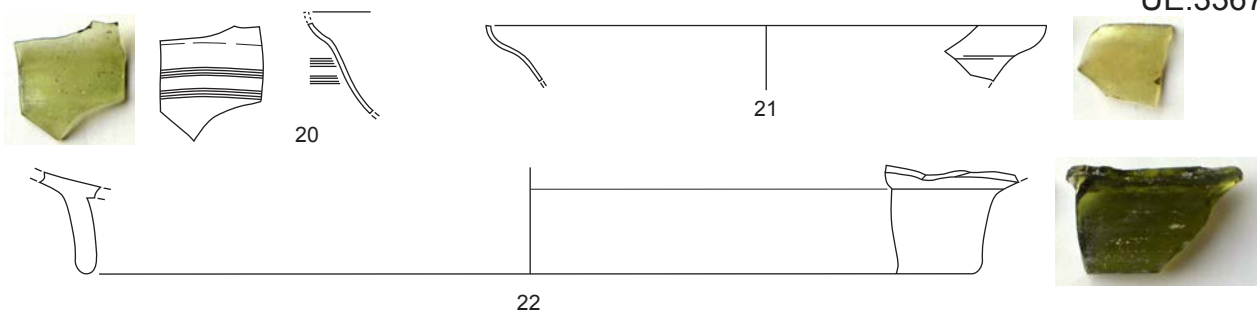

UE.3374

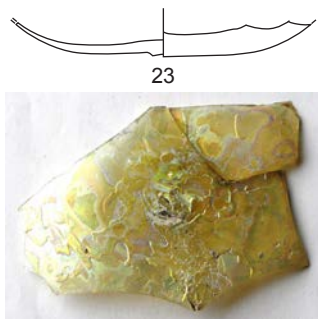

UE.3389

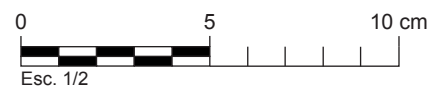
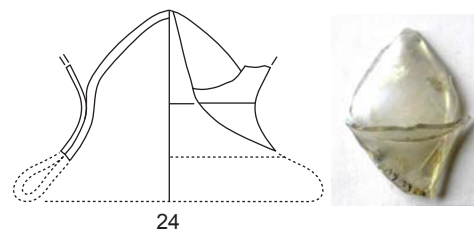

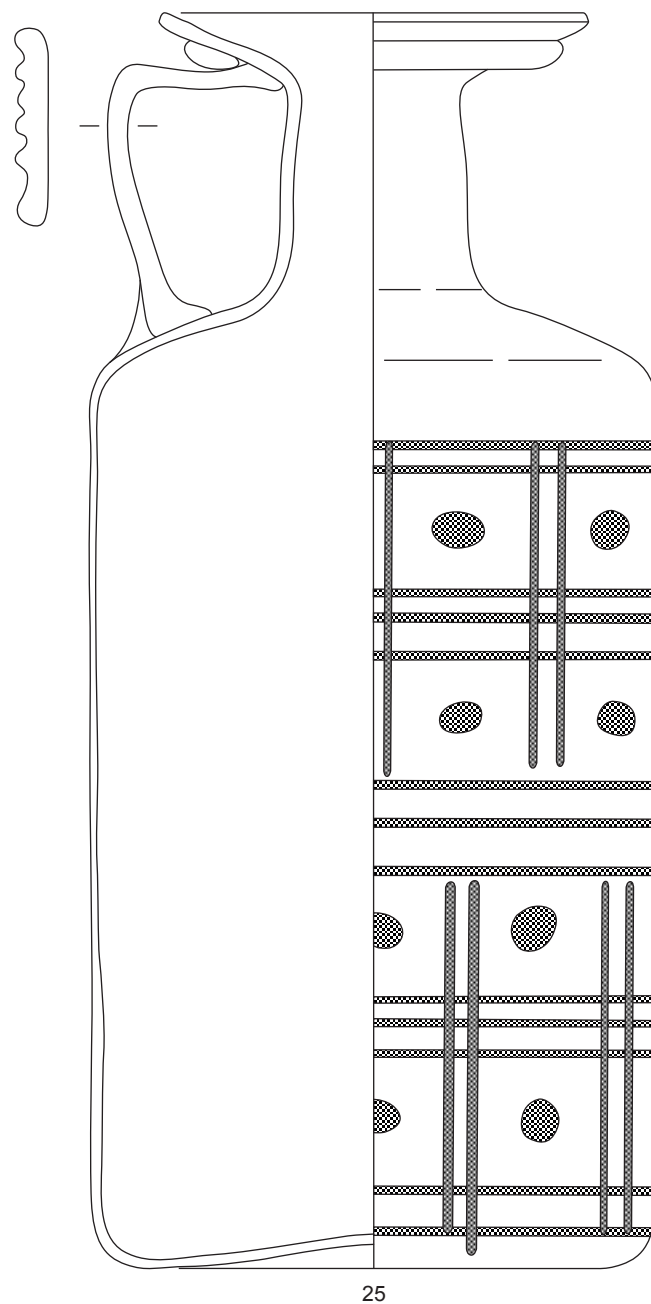

UE.5116

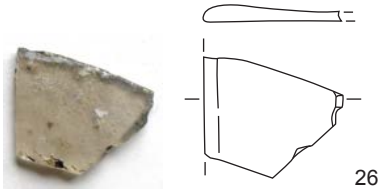

UE.5260

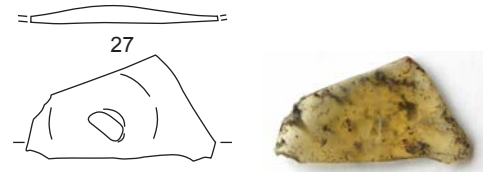

UE.5425

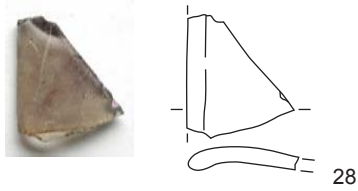

UE.5446

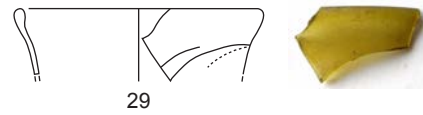

UE.5456

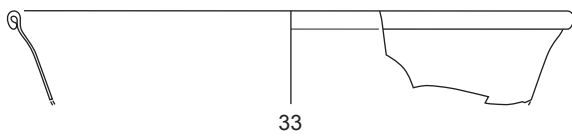
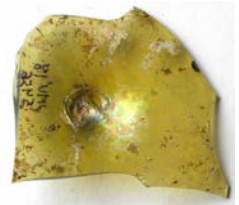
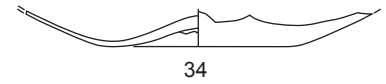
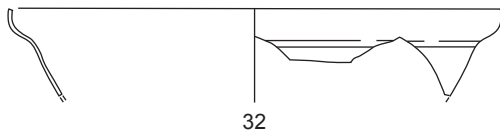
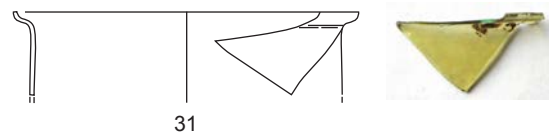
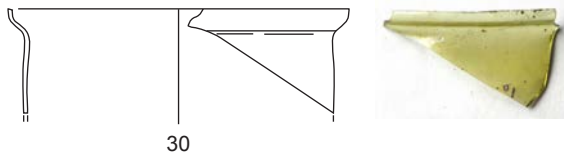

UE.5555

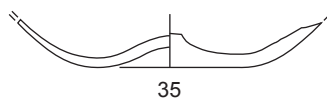

UE.5562



UE.5563

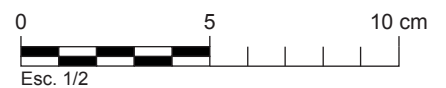

UE.5607

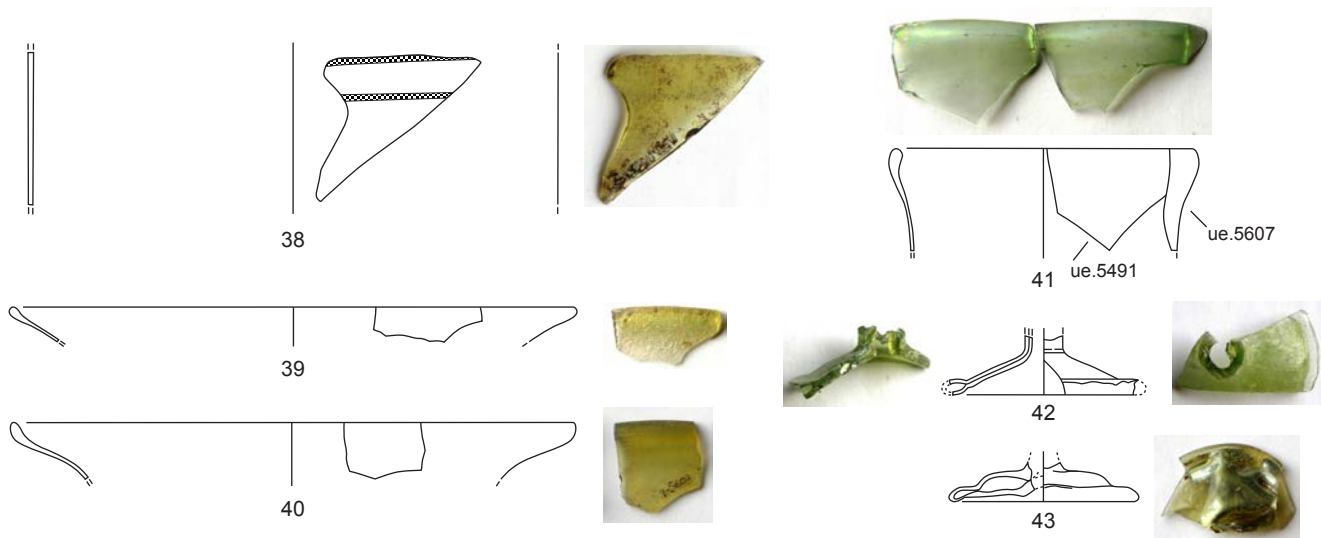

UE.5611

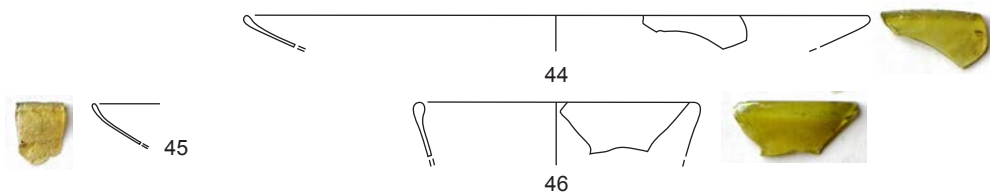

UE.5616



UE.5622



UE.5623

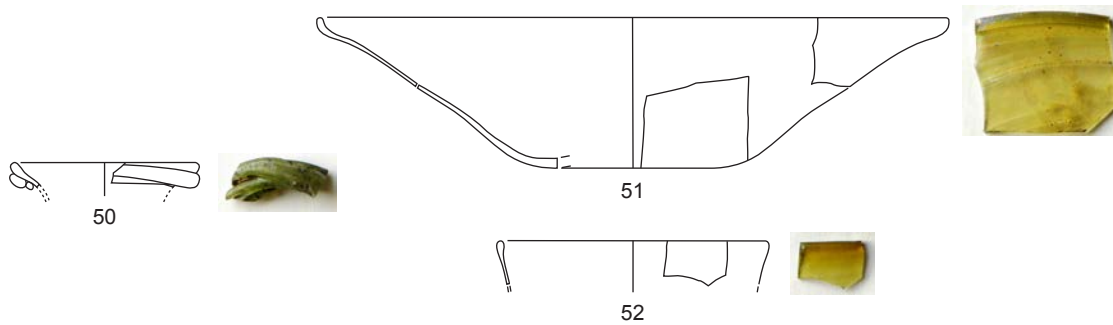

UE.5634

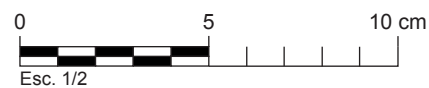
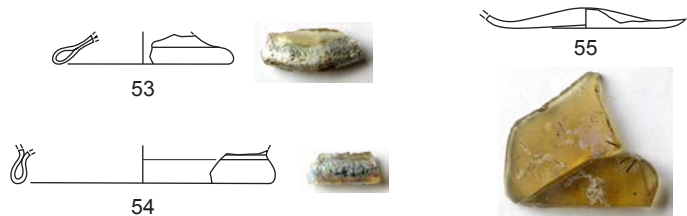

UE.5647

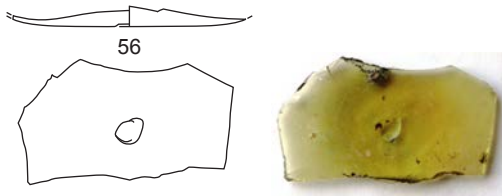

UE.5649

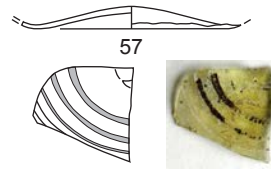

UE.5674

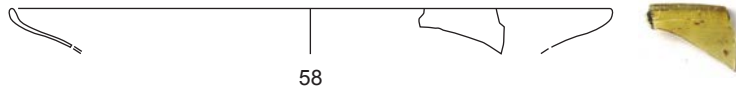

UE.5676

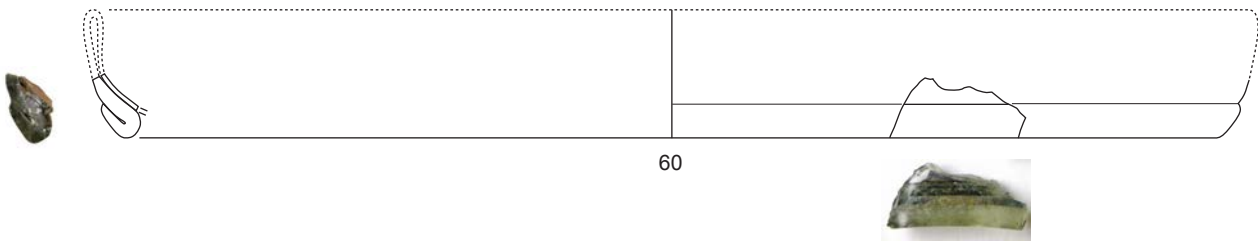
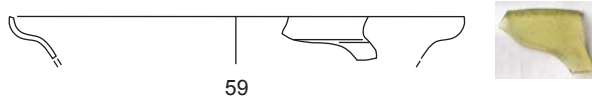

UE.5702

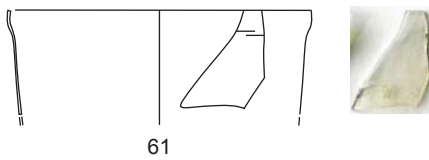

UE.5717



UE.5726

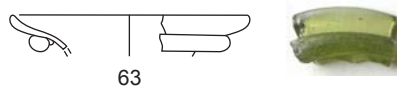

Mas d'en Verd de Farena (Mont-ral)

Tomba 1

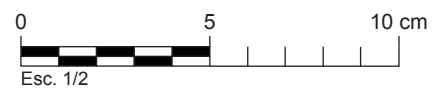
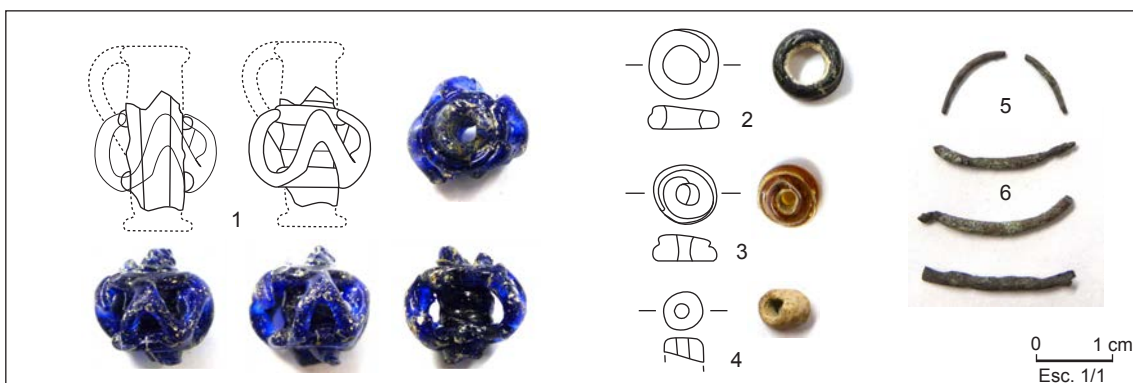

VILARDIDA (Montferri, Alt Camp), 2018-2019. MAS D'EN VERD (Mont-ral, Alt Camp), 1954  
 Vilardida, UEs: 5647, 5649, 5674, 5676, 5702, 5717 i 5726. Mas d'en Verd, Tomba 1.  
 Cronologia: s. IV-VIII

LÀMINA 410

UE.1001

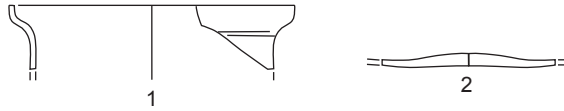

UE.1101



UE.1119



UE.1136



UE.1143



UE.1204

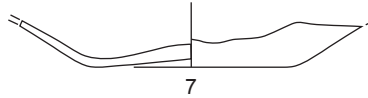

UE.1206

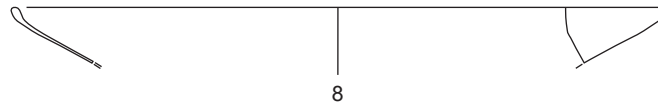

UE.2204

SB-contrapès premsa

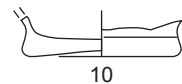
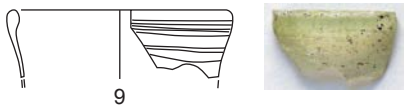

SC-NP-C

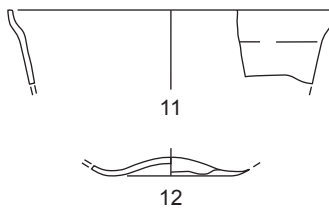

SC-C1-N5

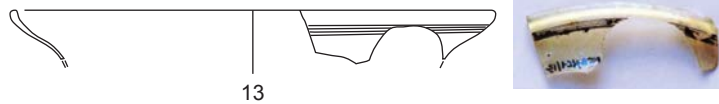

Supeficial-1988

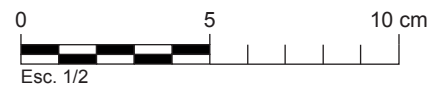

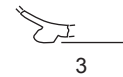
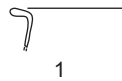

---

Cala T-Sud, nivell paviment

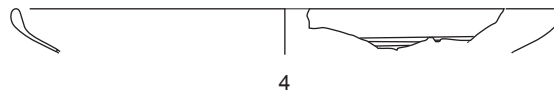

---

Cala T-Nord, àmbit 2-nivell 1

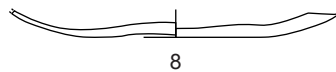
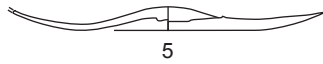

---

Conjunt XIV, nivell 1

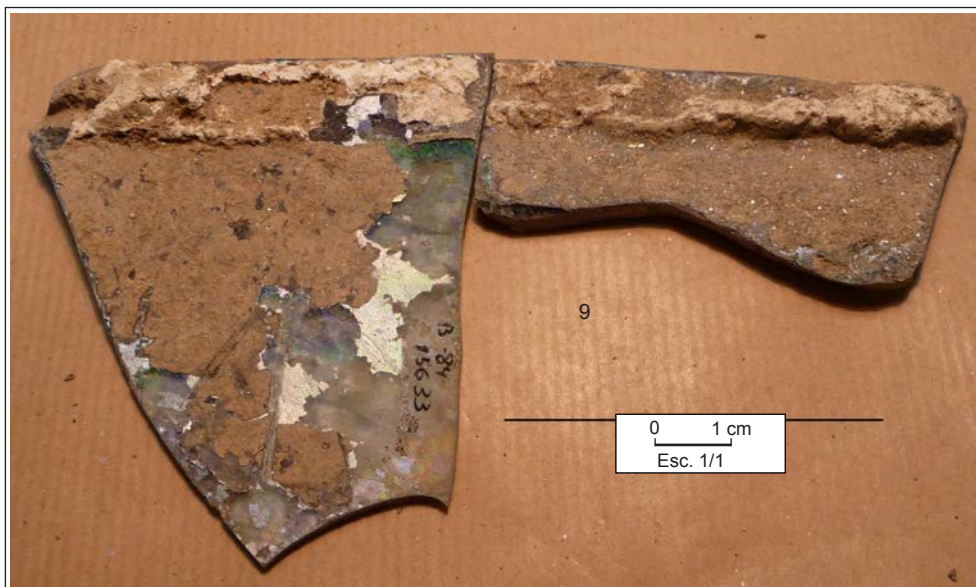

Fotografia de Margarida Genera 2009. N° registre B'84-15633

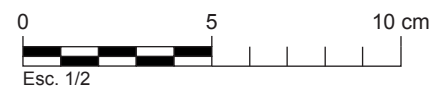



UE.301

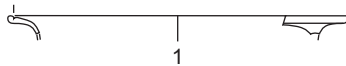

UE.303

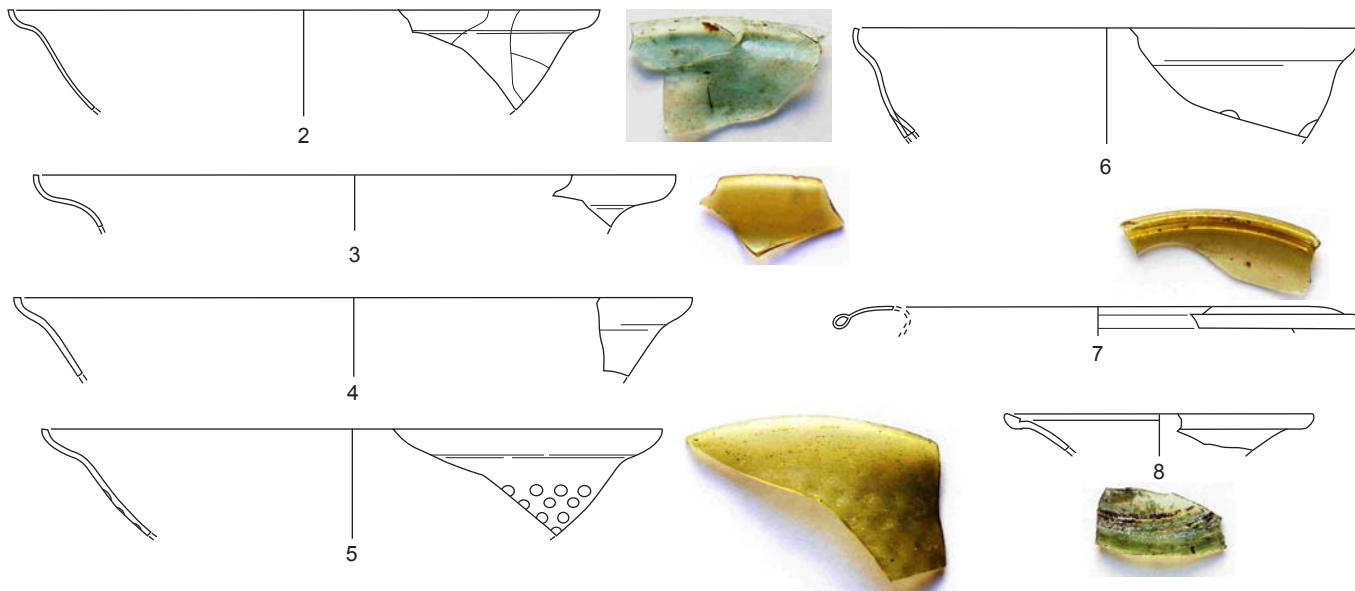

UE.304



UE.309

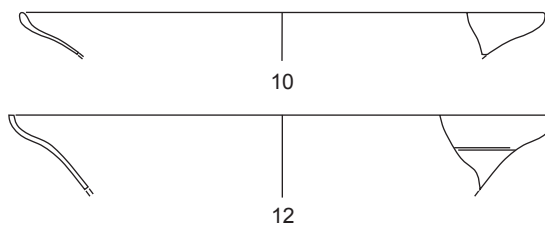

UE.317

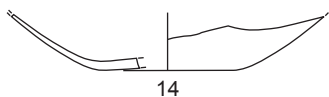

UE.318



UE.320

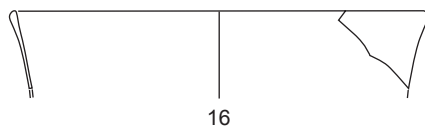

UE.104

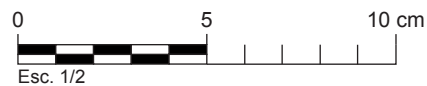
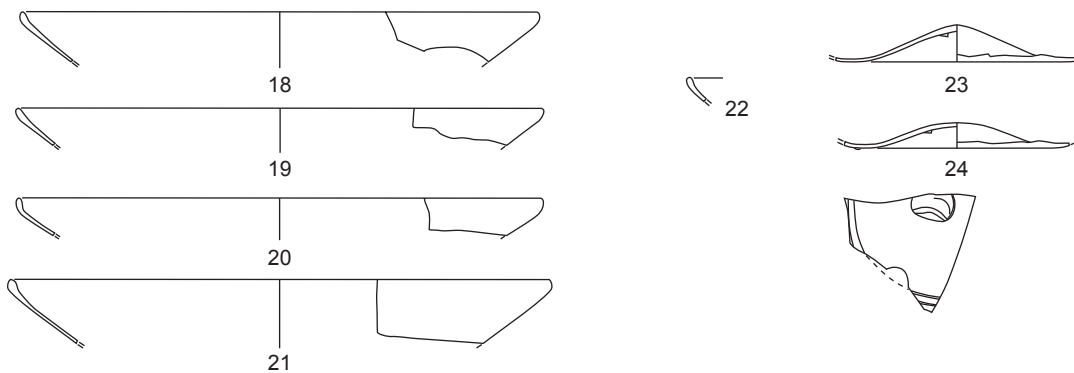

UE.2036

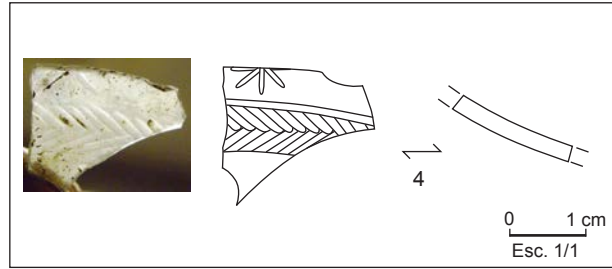
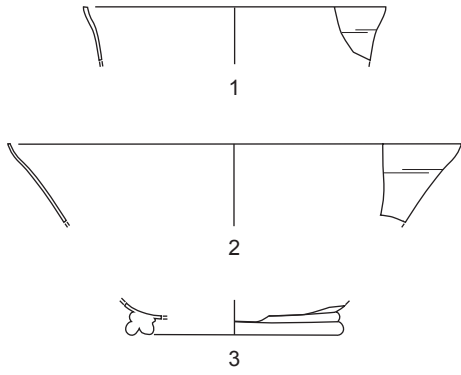

UE.2060

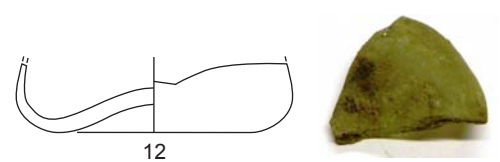
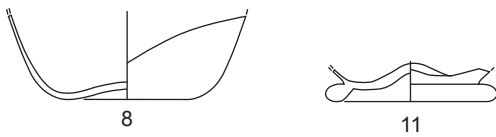
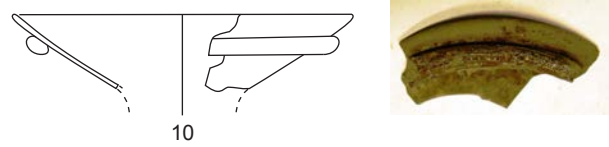
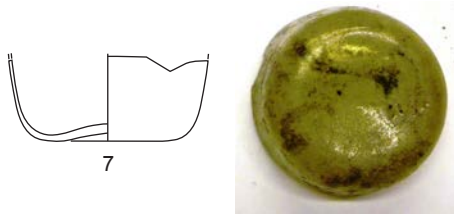
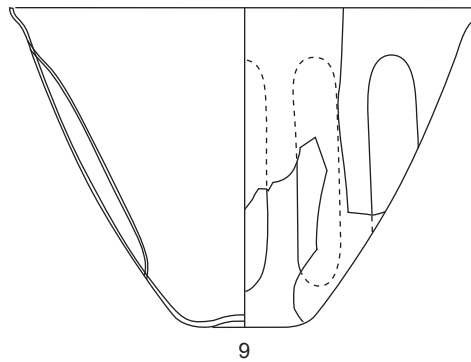
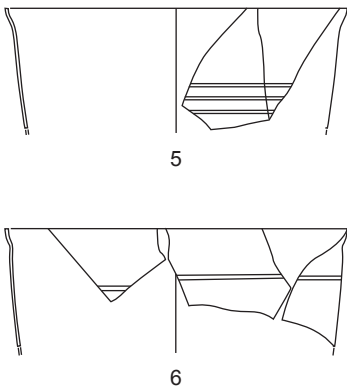

UE.2063

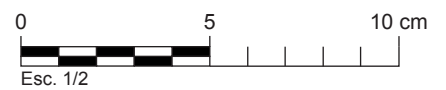
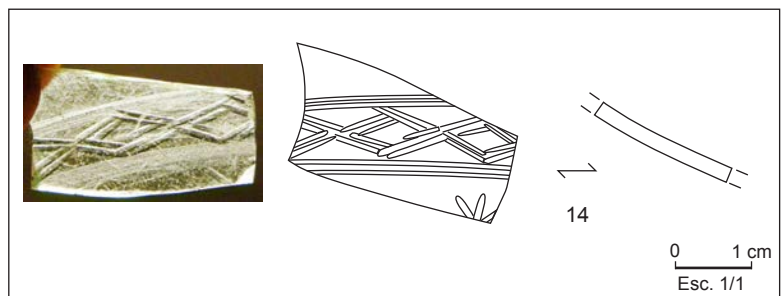

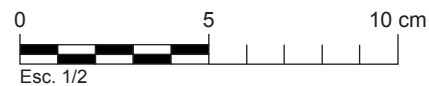
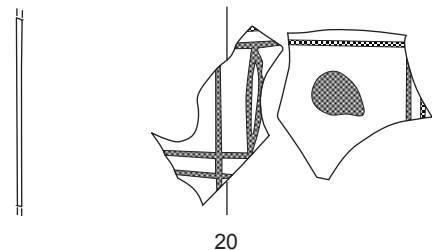
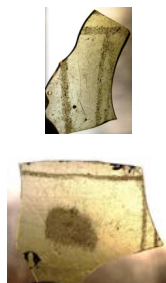
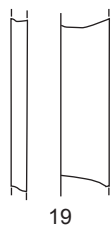
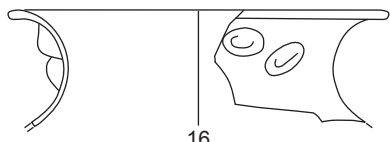
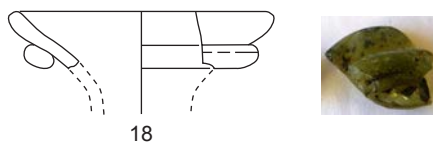
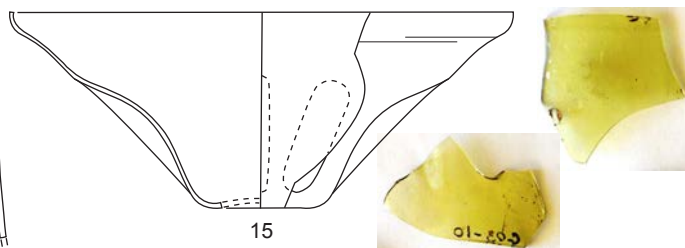
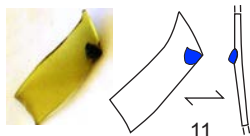
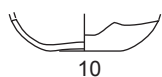
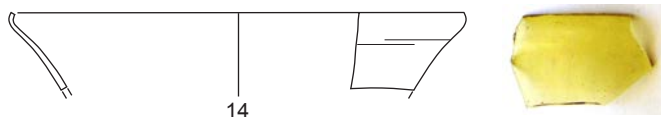
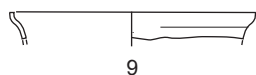
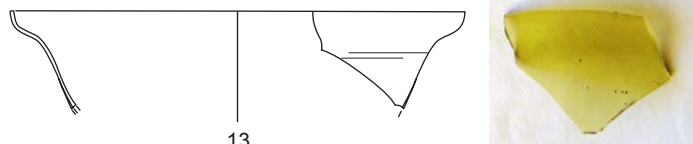
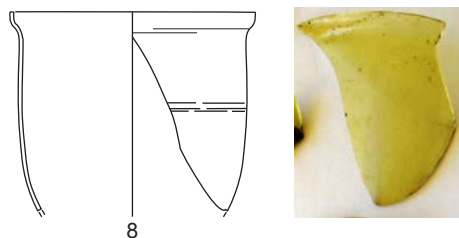
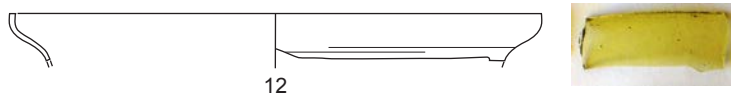
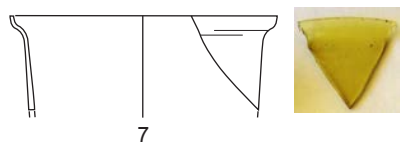
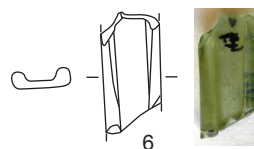
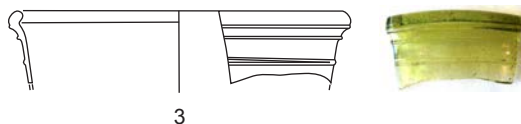
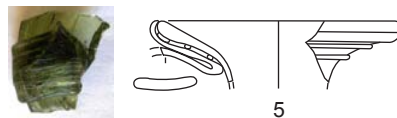
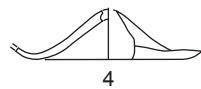
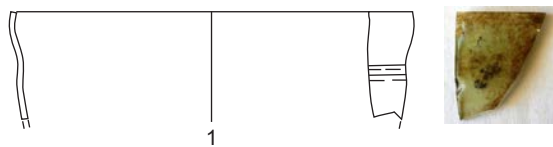

Guissona 2003

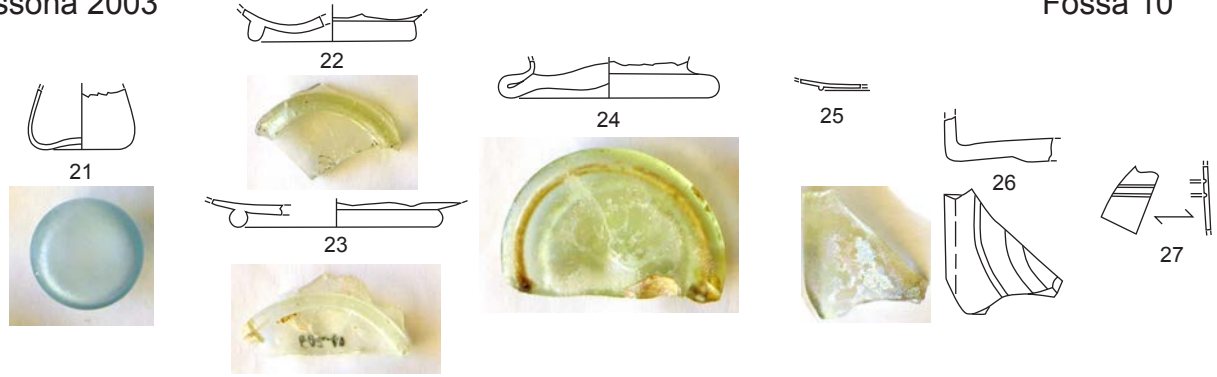

Fossa 10

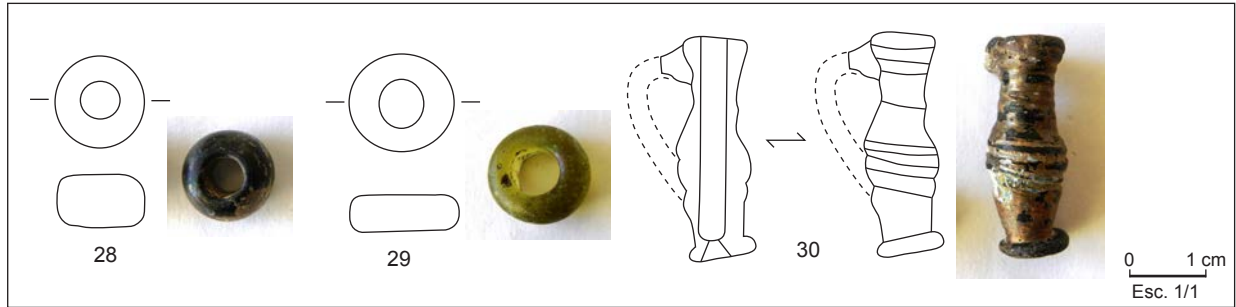

Guissona-Casa I 1999

Període 7



Període 5

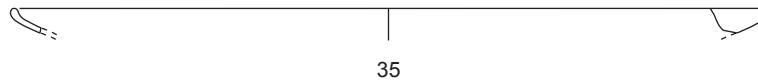

Període 4A-Torcular

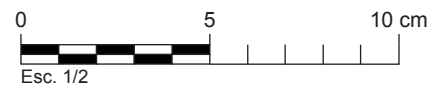
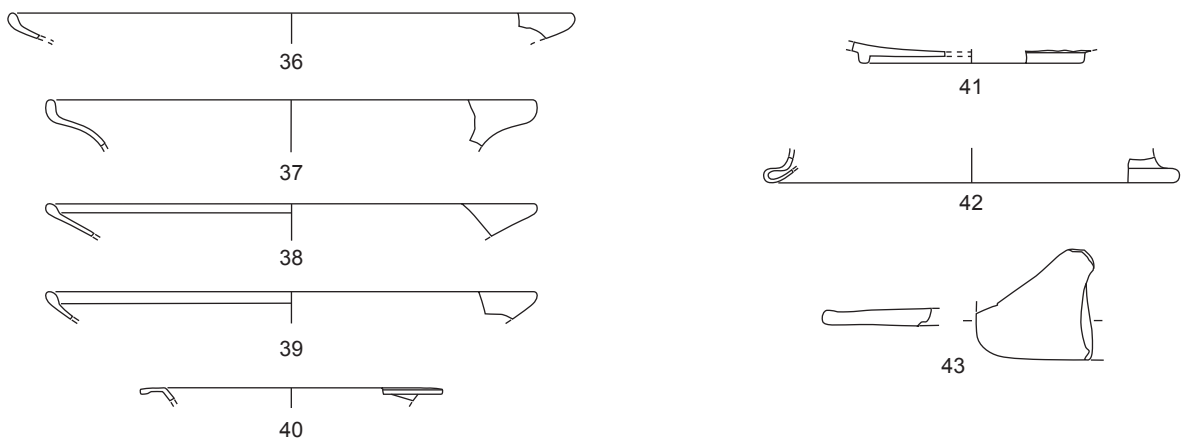

Guissona-Casa I 1999

Període 4A-Calculatorium

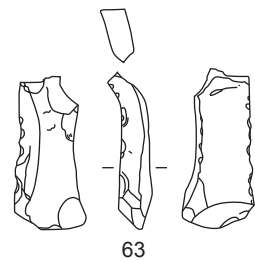
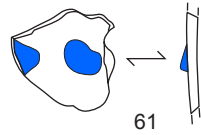
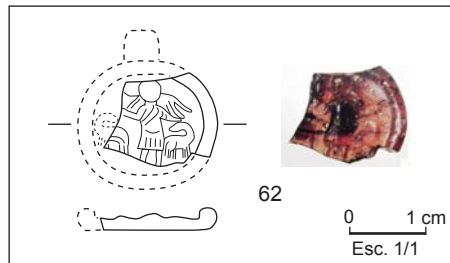
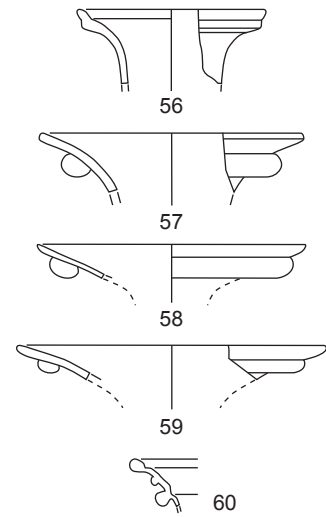
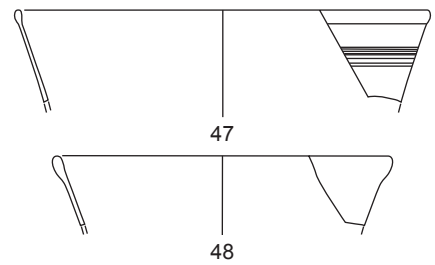
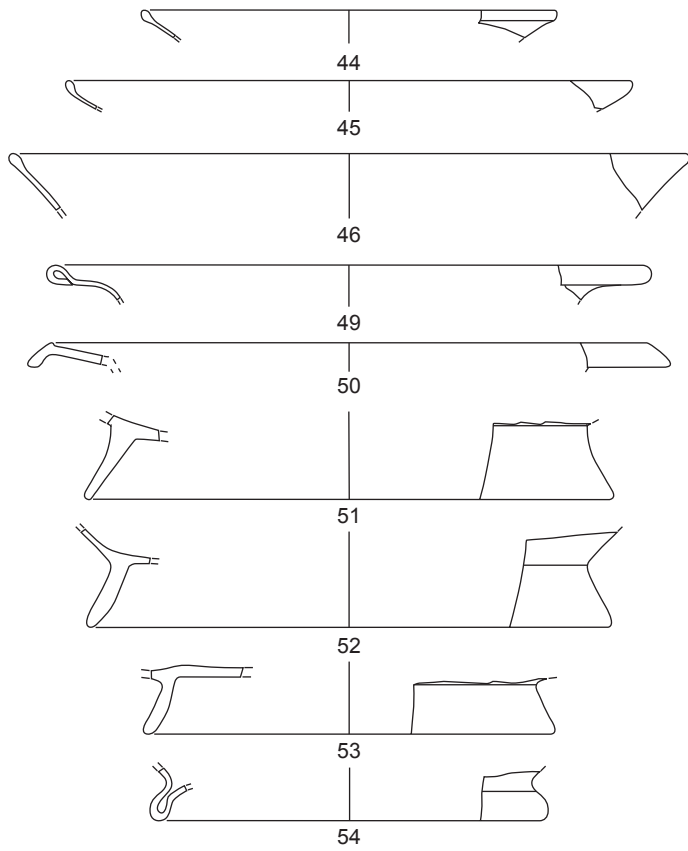

Període 4B

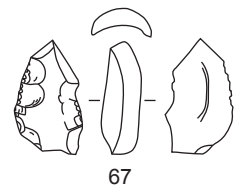
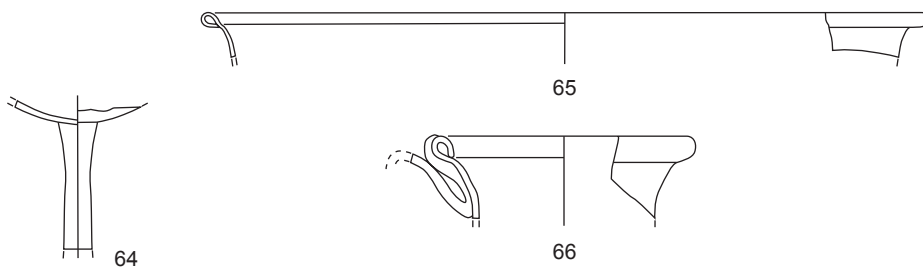

Període 2C

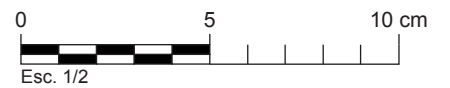
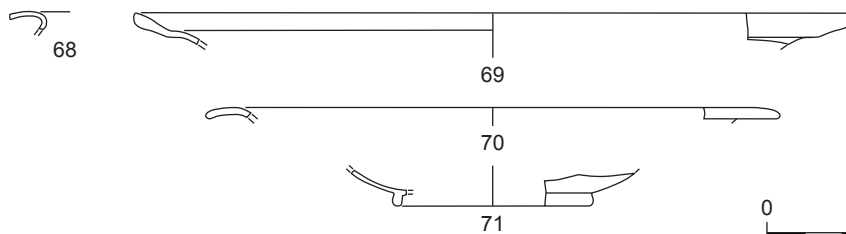

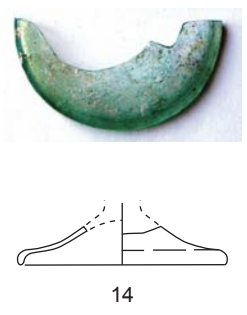
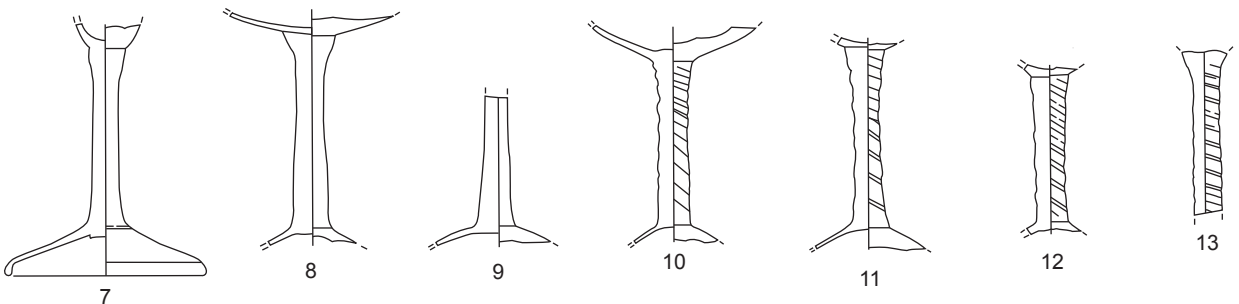
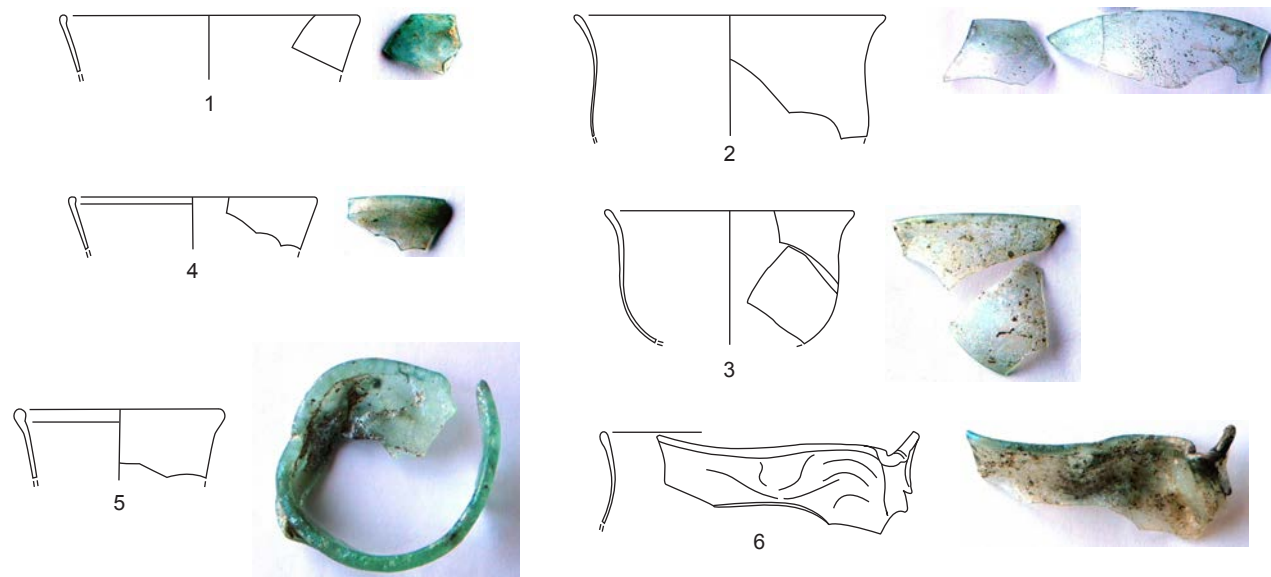

Fotografia de Roderic Pita  
1968

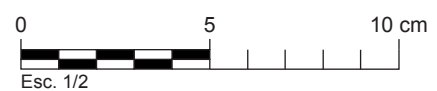

SECTOR PROTHESIS

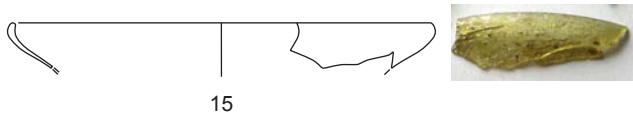

15



16

SECTOR CUADRO 1 TRINXERA

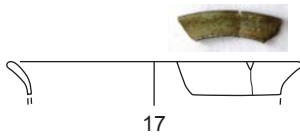

17

SECTOR CUADRO 2 TRINXERA

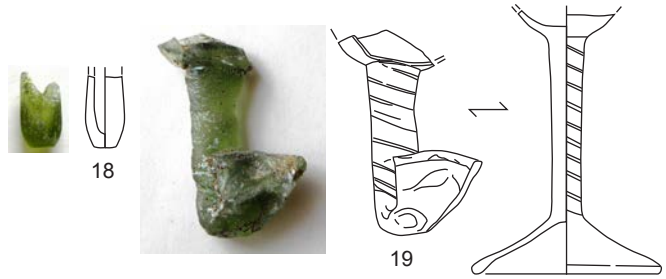

18

19

SECTOR P.45

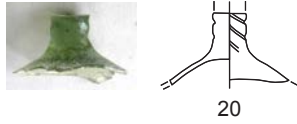

20

SECTOR P.46

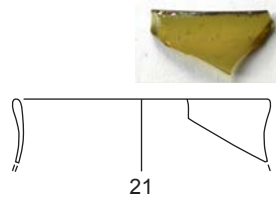

21

SECTOR III

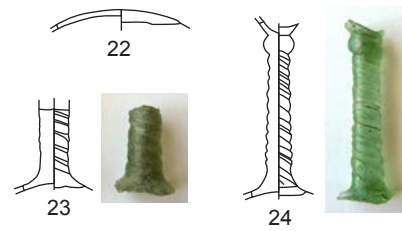

22

23

24

SECTOR IV



25

SECTOR V

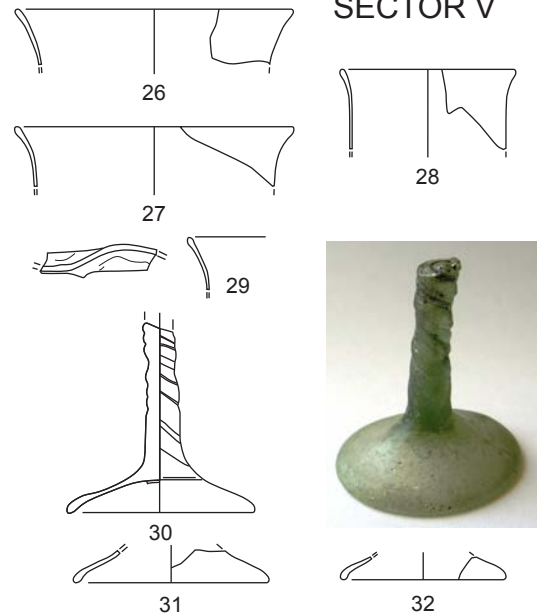

26

27

28

29

30

31

32

SECTOR VI

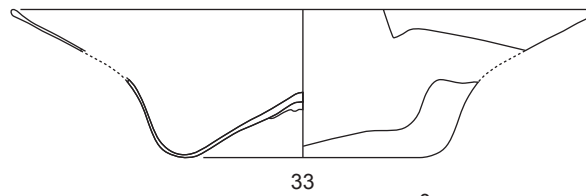

33

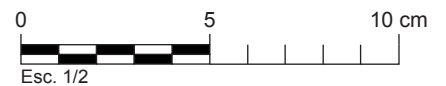

SECTOR VII Corredor

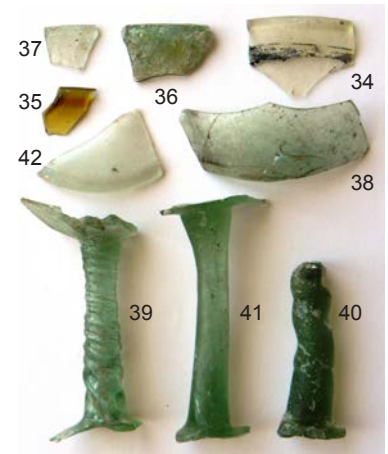
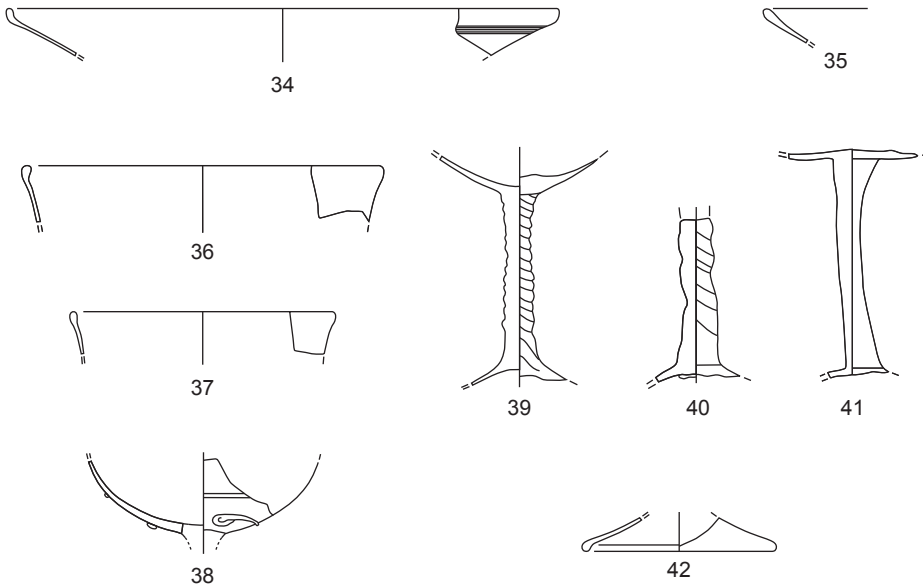

SECTOR VII. HAB. 01

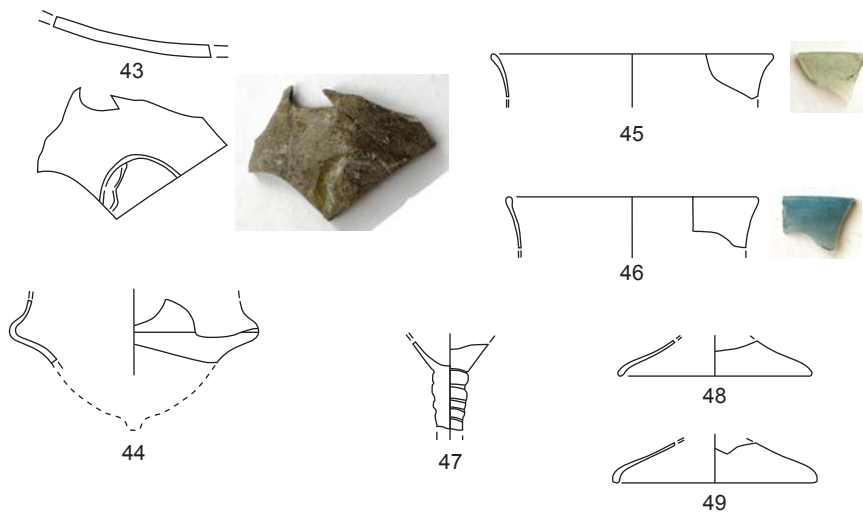

SECTOR VII. HAB. 1

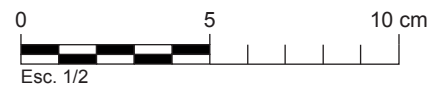
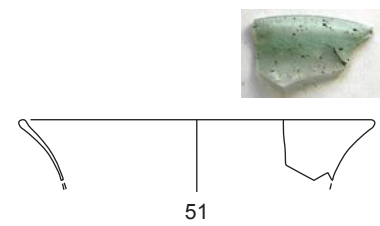
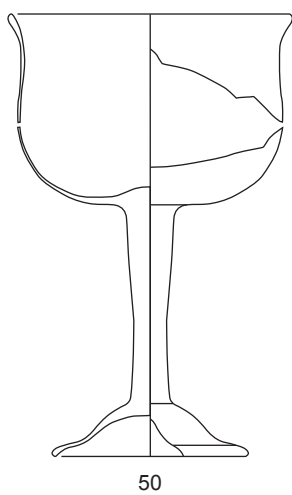





SECTOR VII. HAB. 7

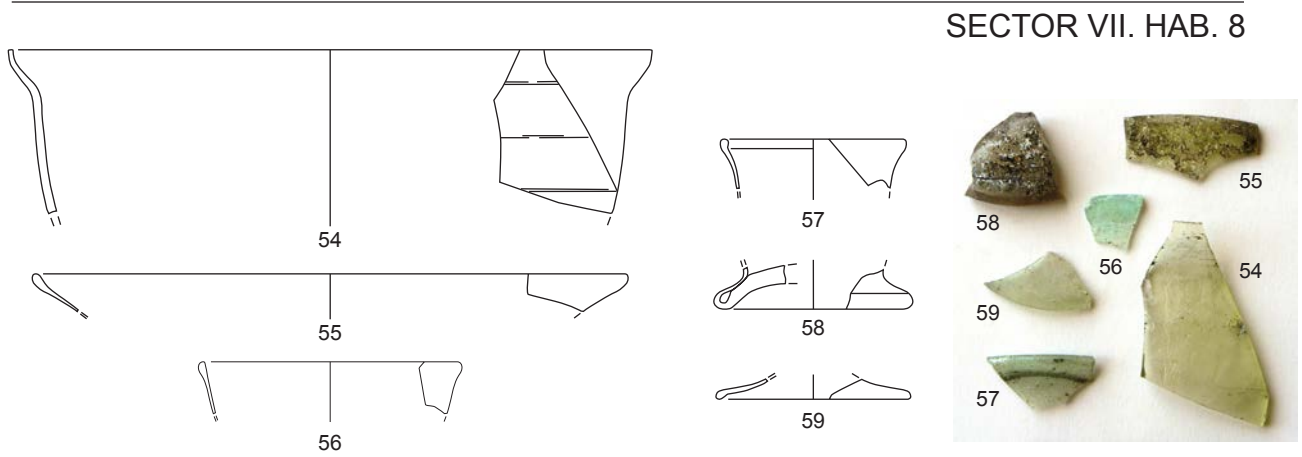

SECTOR VII. HAB. 8

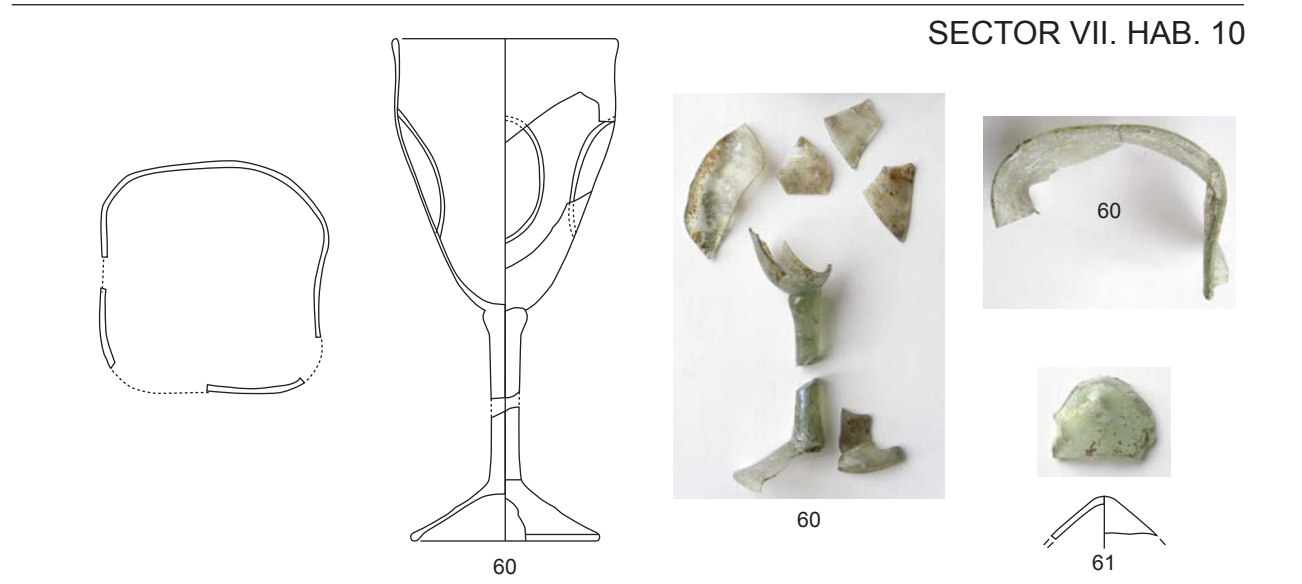

SECTOR VII. HAB. 10

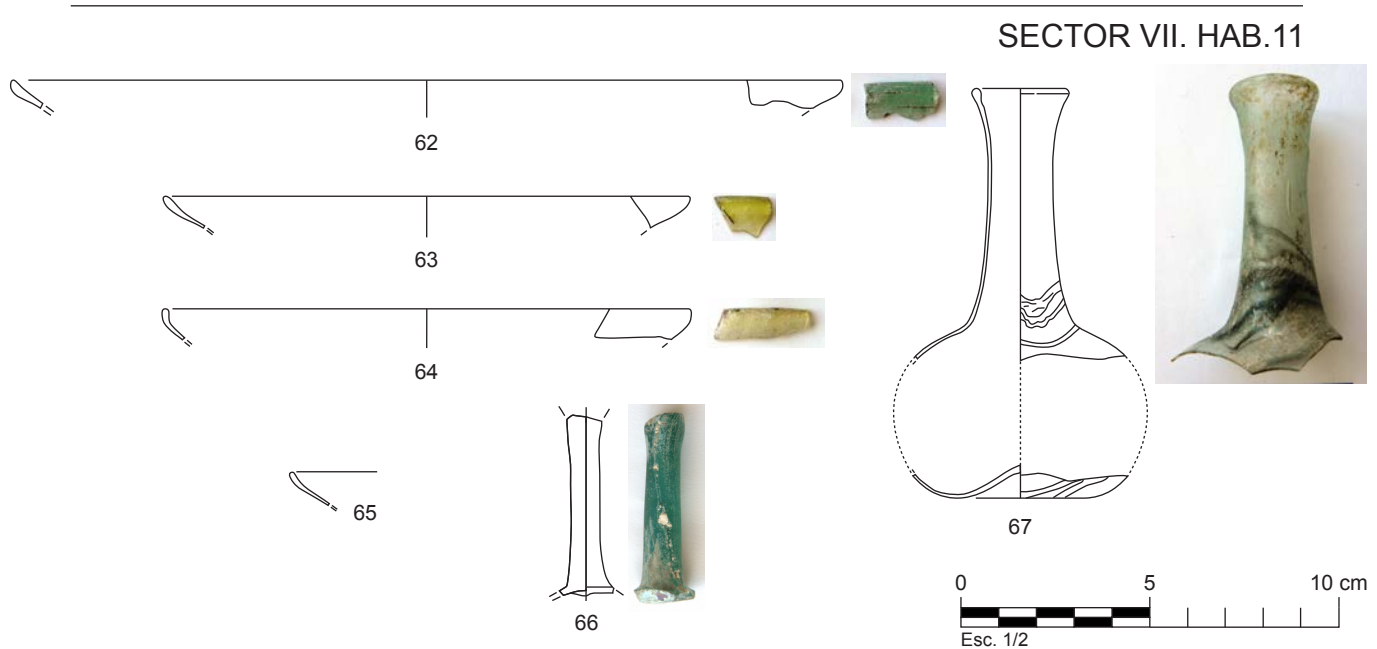

SECTOR VII. HAB. 11

SECTOR VII. HAB. 12

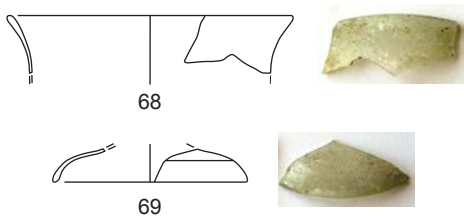

SECTOR VII. HAB. 13

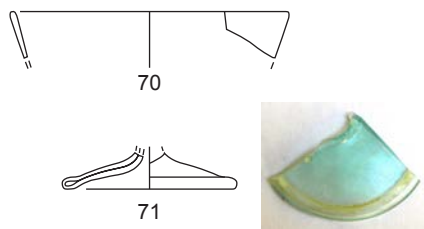

SECTOR VII. HAB. 14

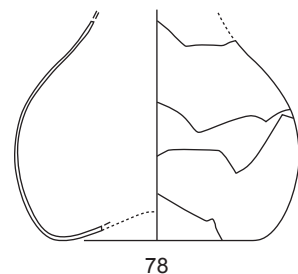
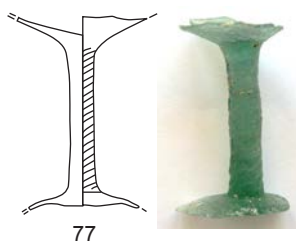
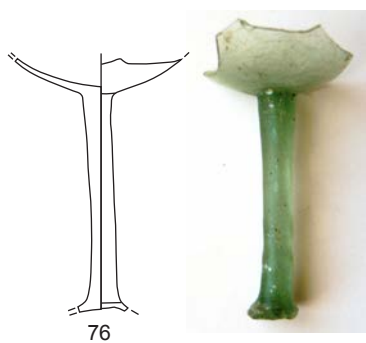
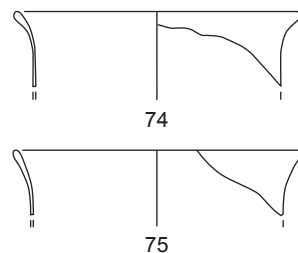
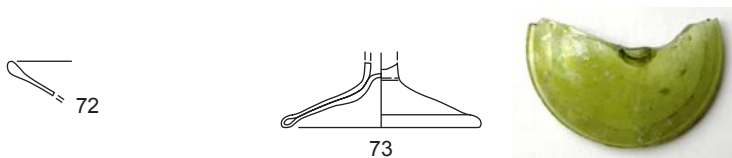

SECTOR VII. HAB. 15

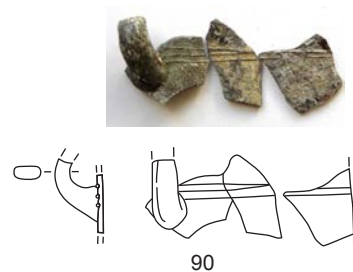
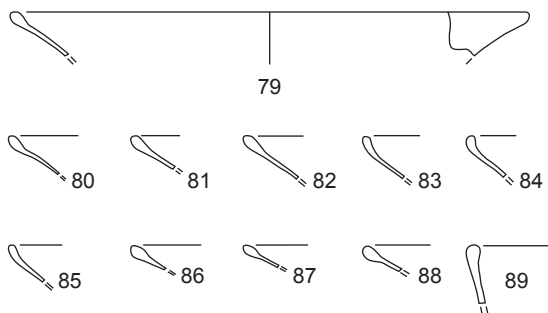

SECTOR VII. SENSE CONTEXT

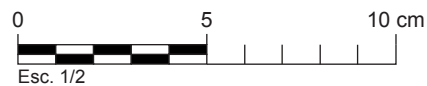
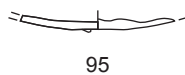
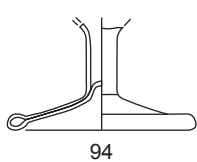
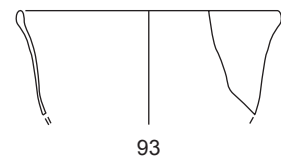
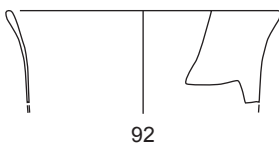
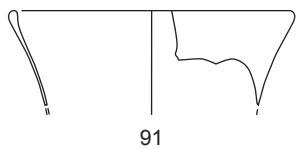

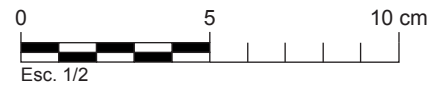
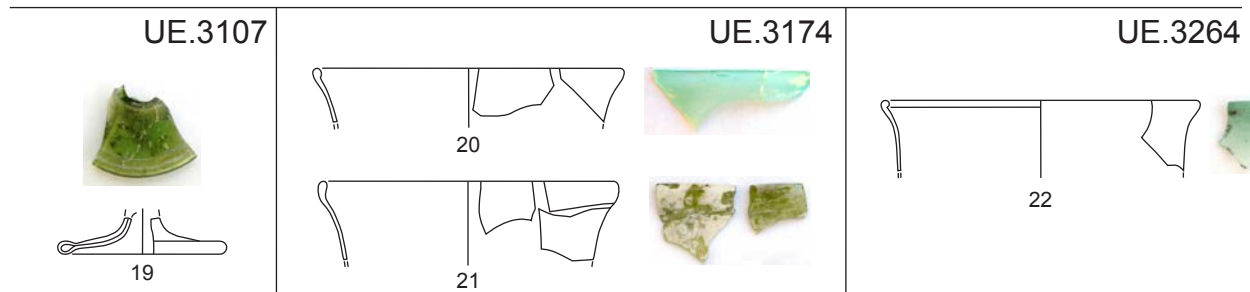
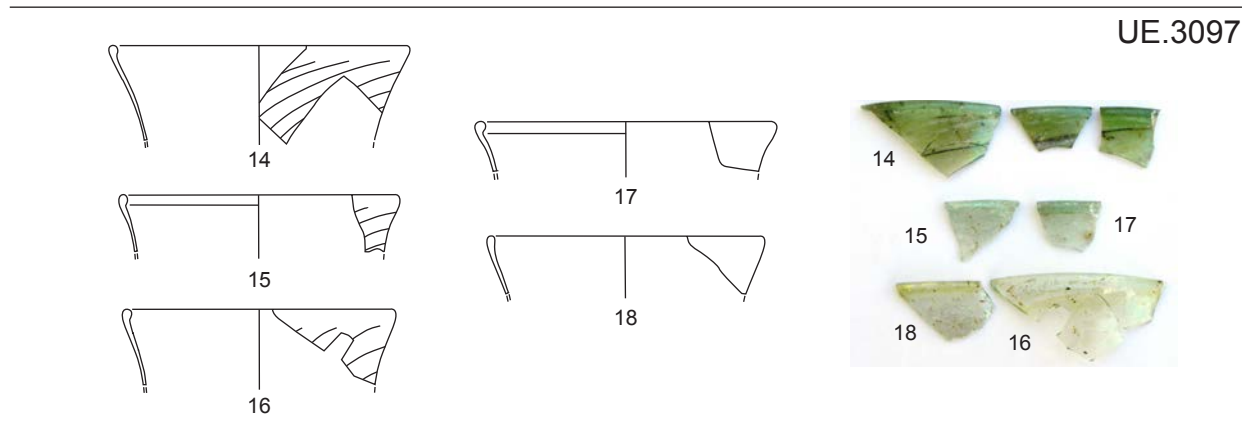
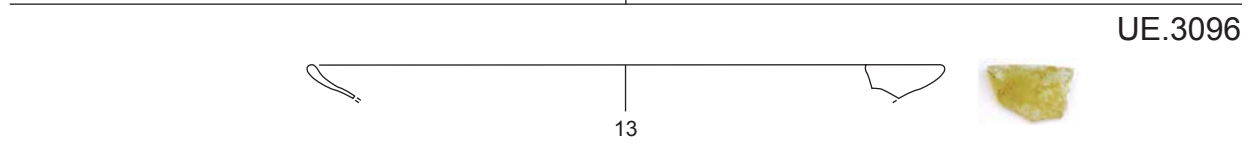
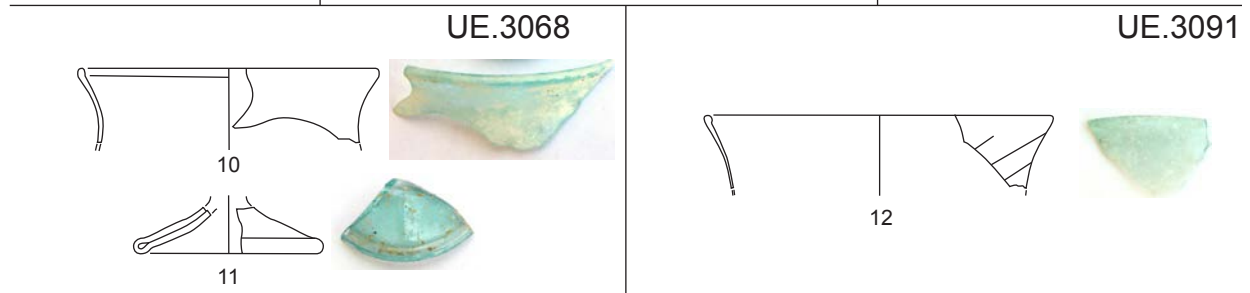
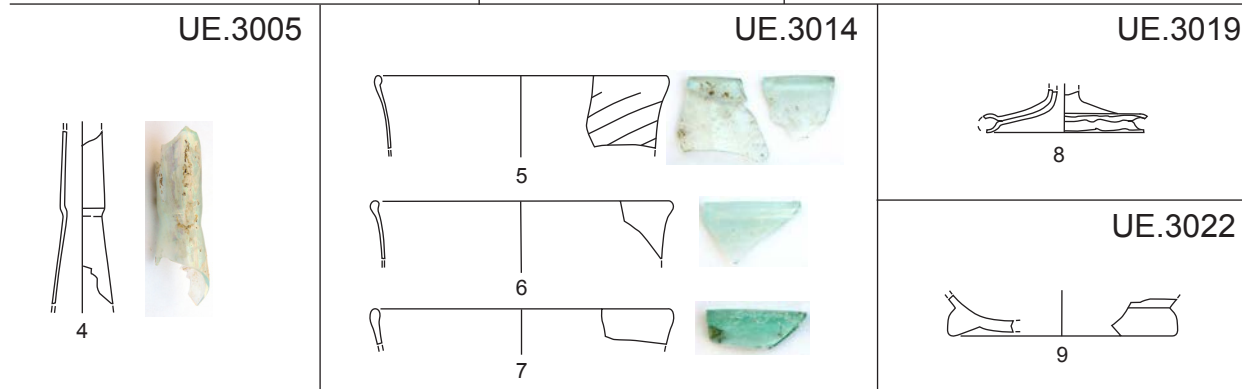
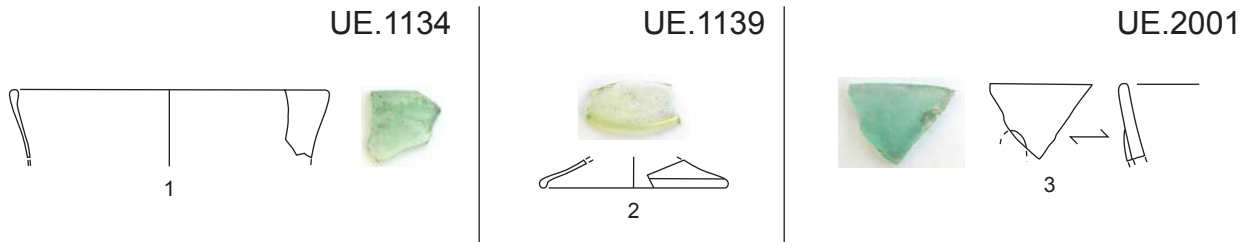

UE.3293

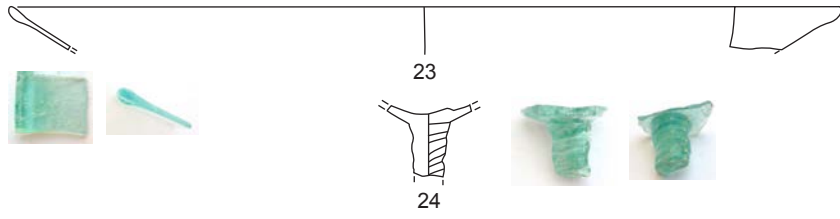

UE.3315



UE.3325



UE.3329

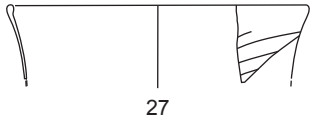

UE.3362

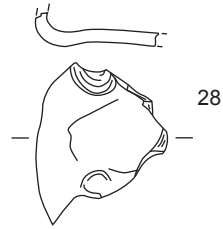

UE.3373

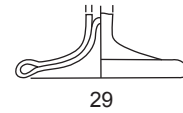

UE.3404

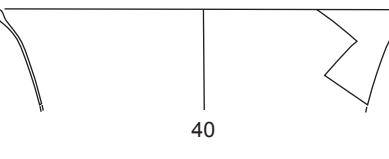
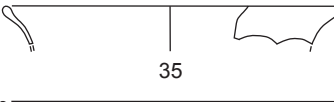
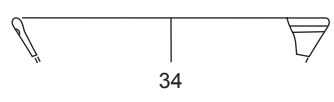
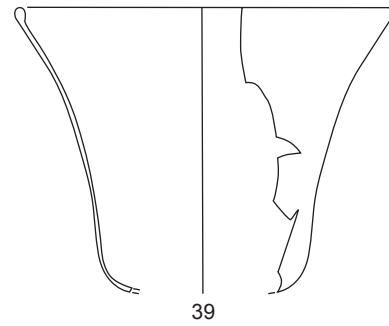
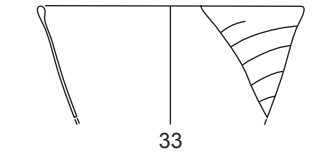
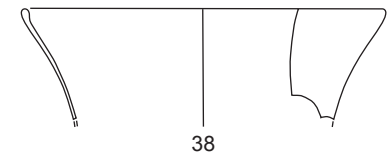
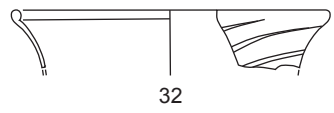
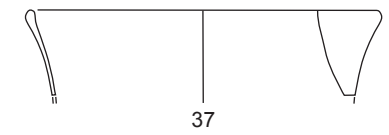
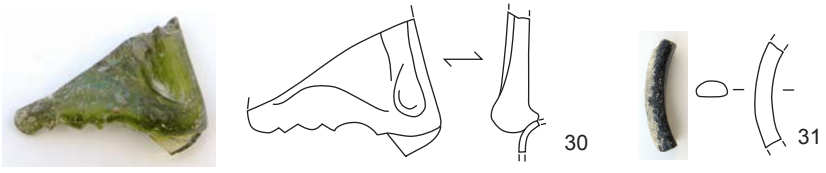

UE.3441

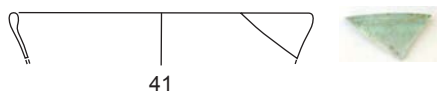

UE.3595

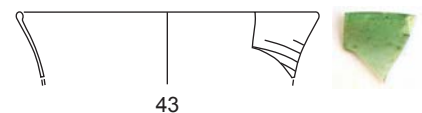

UE.3469

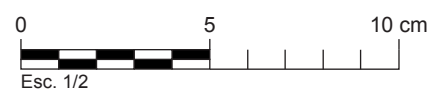
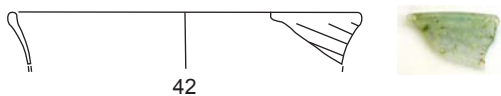

UE.8142

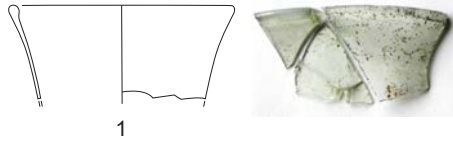

UE.8159



UE.8529

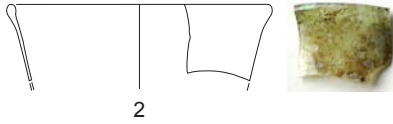

UE.8150

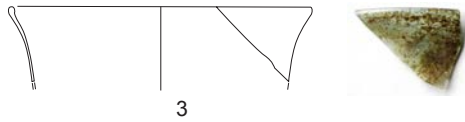

UE.8161

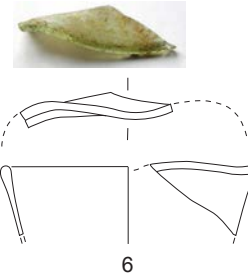

UE.8161

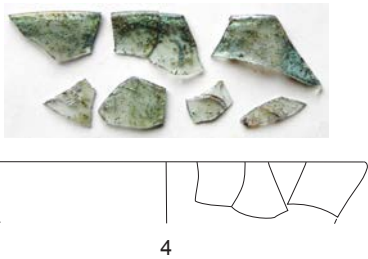

UE.8142

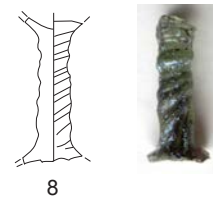

UE.6143

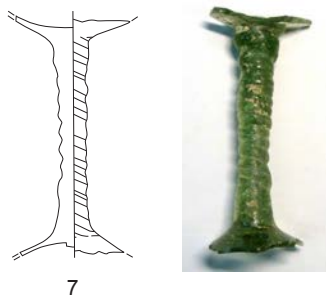

UE.6033



UE.8001

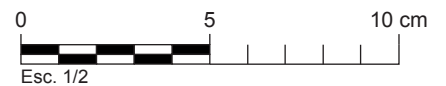
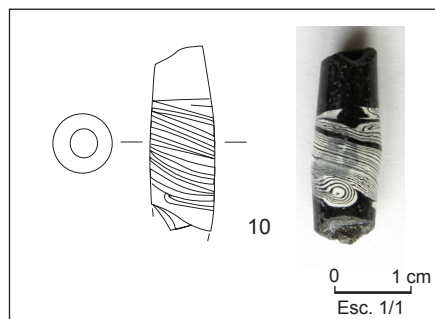

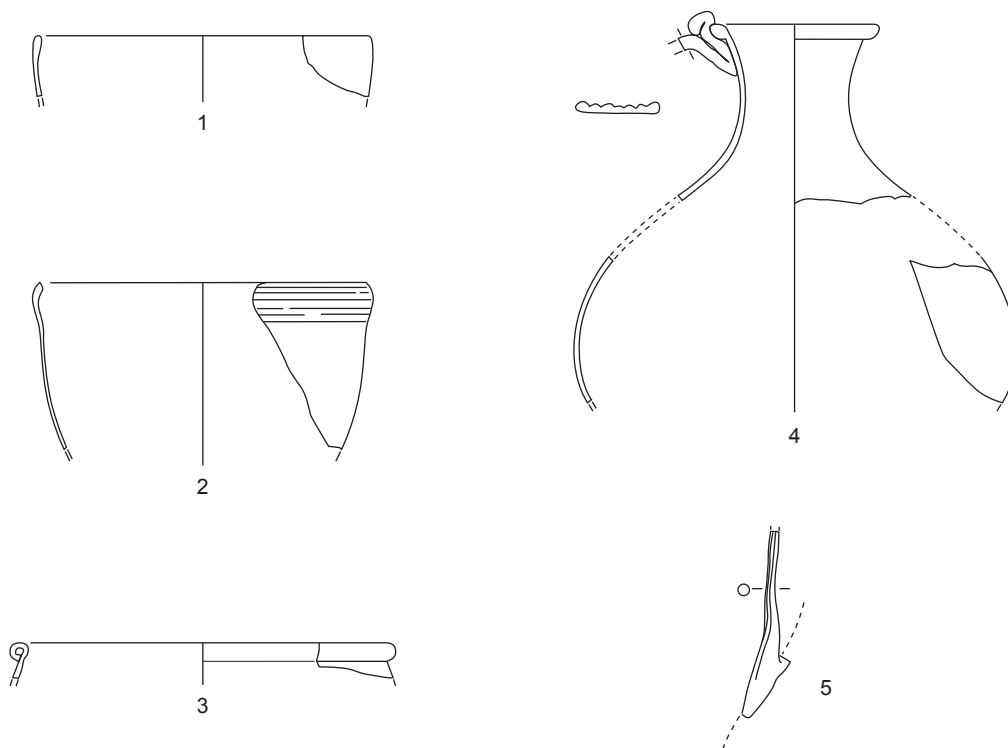

---

---

COVA COLOMERA 1983

Sector C

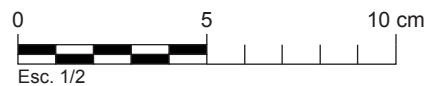
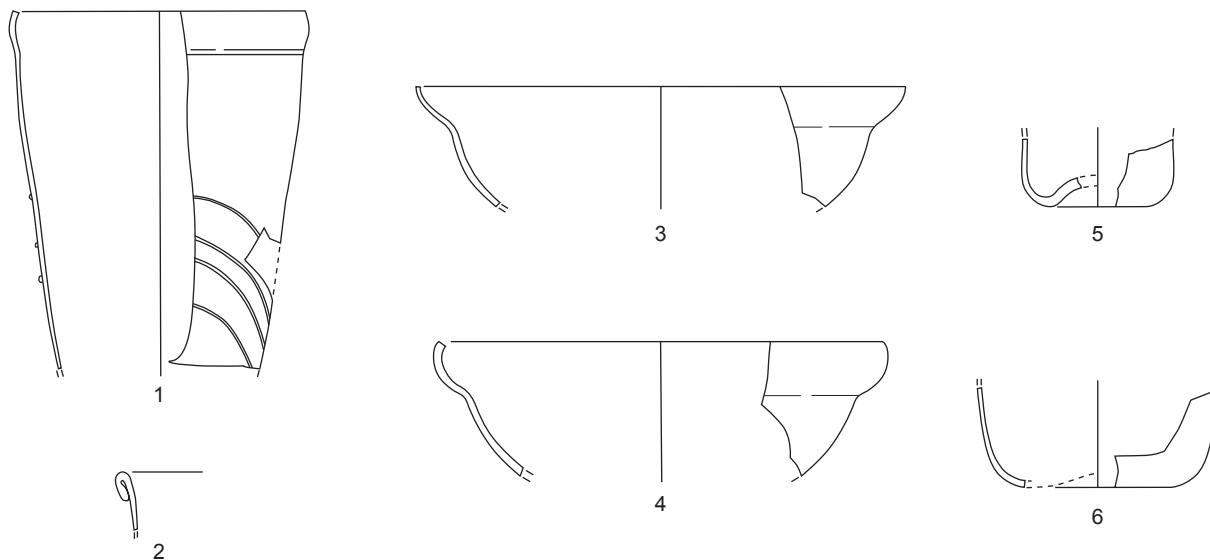

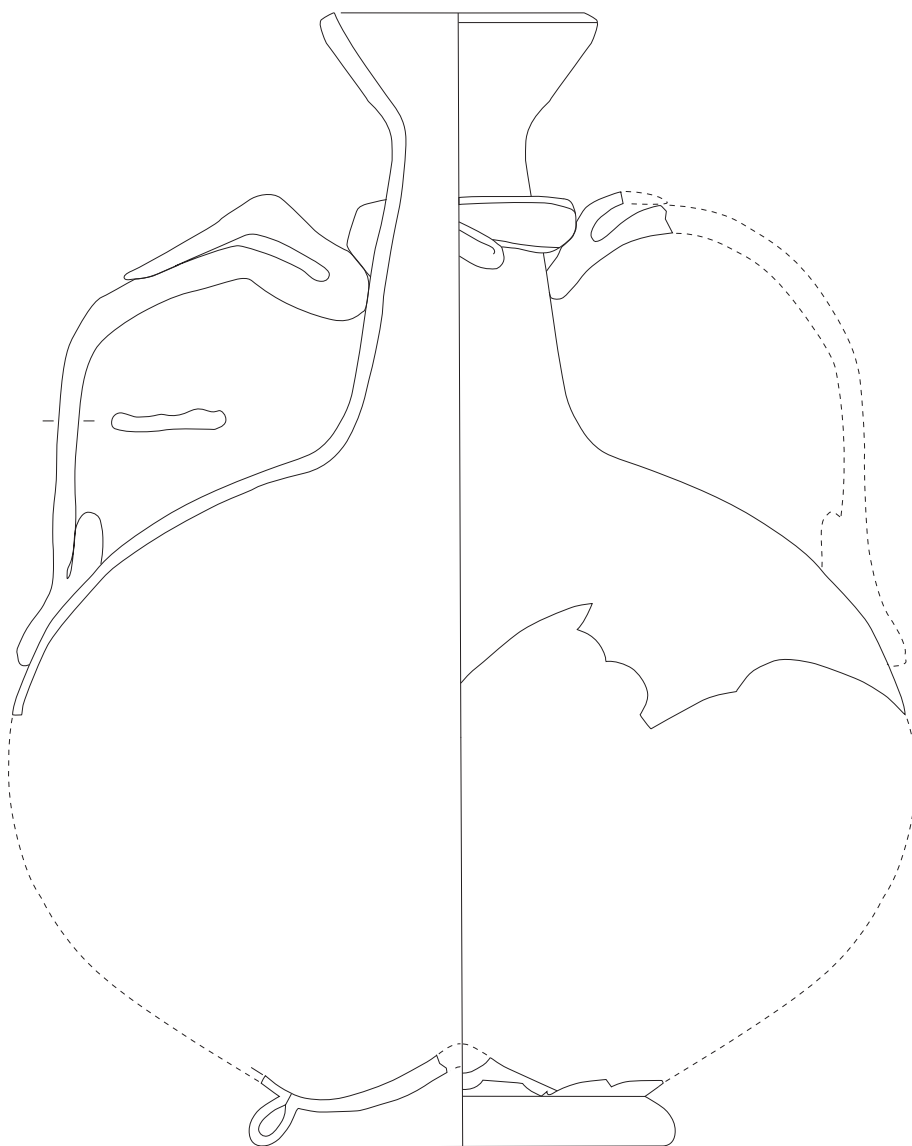
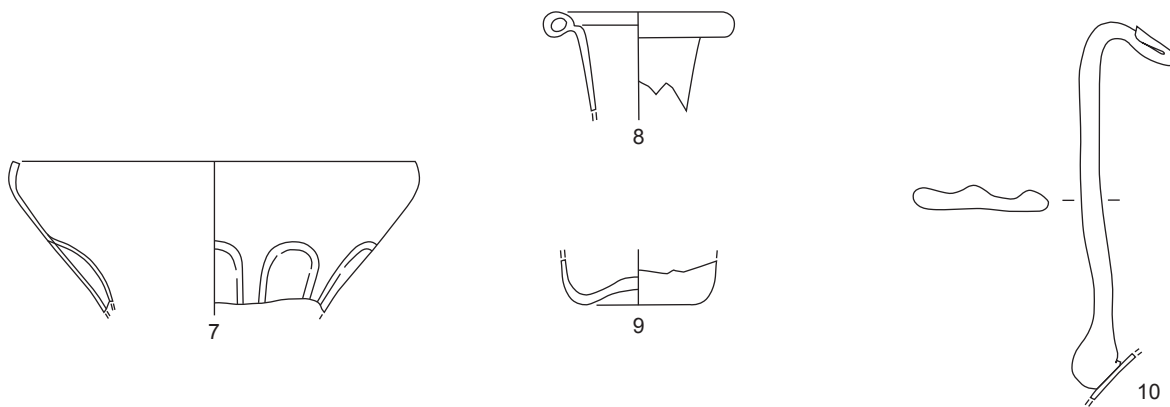

11

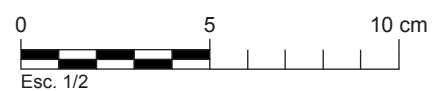

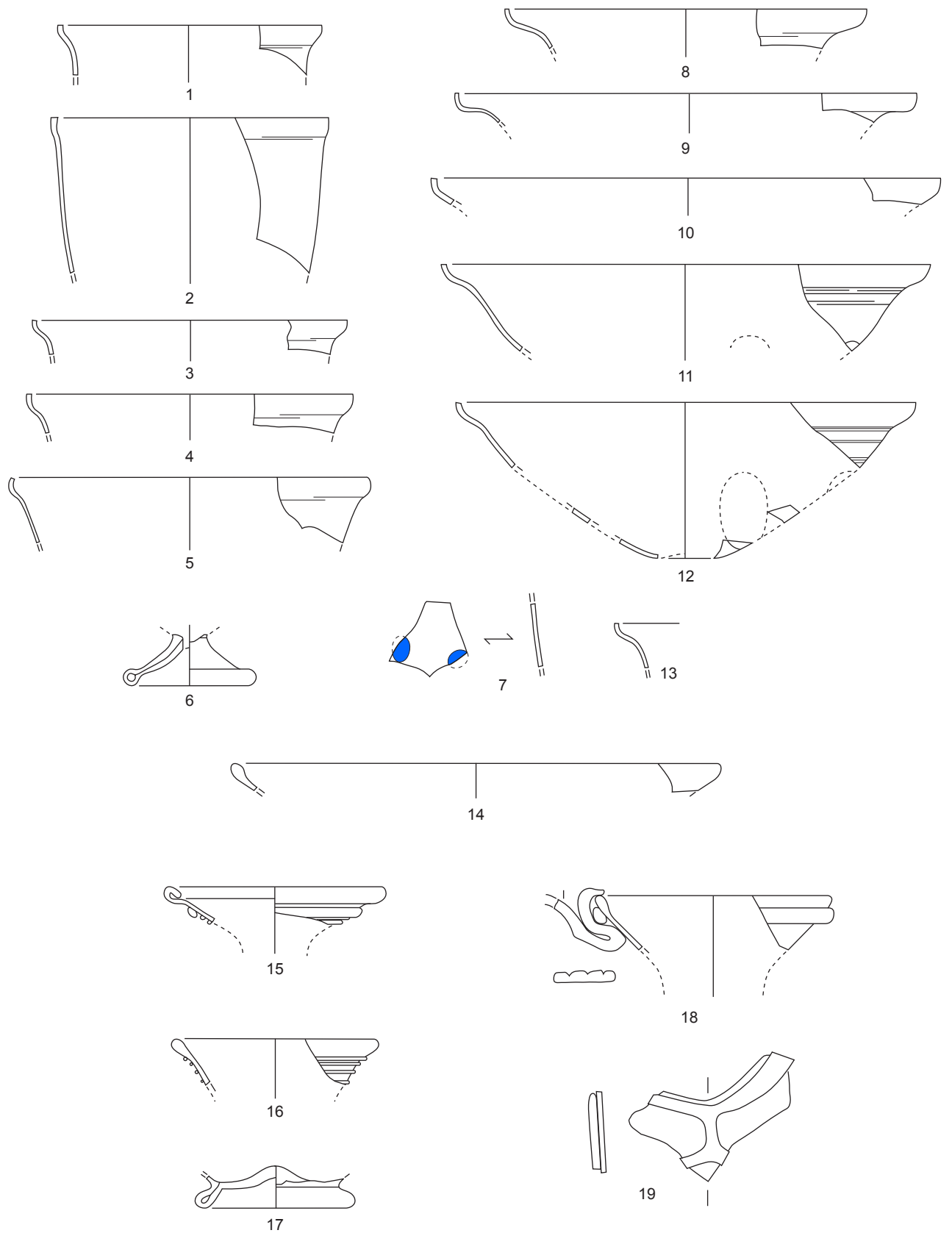

0 5 10 cm  
Esc. 1/2



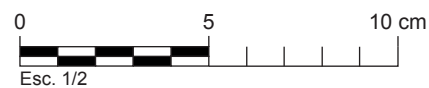
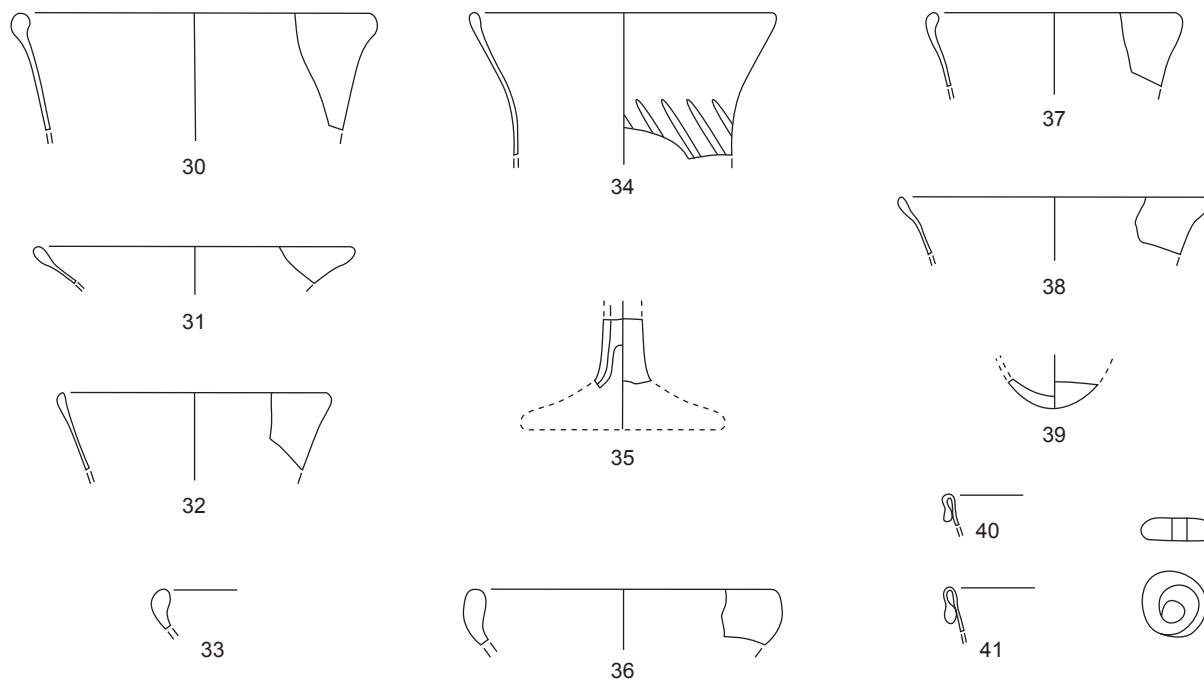
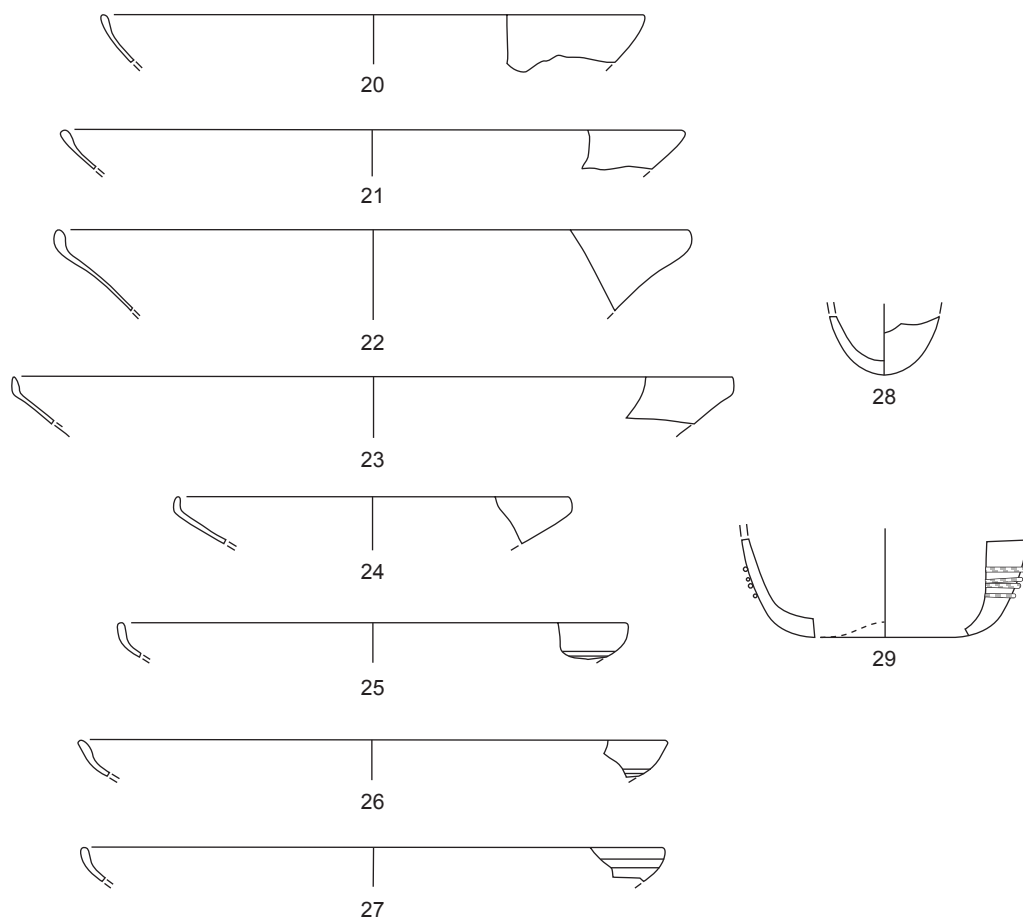

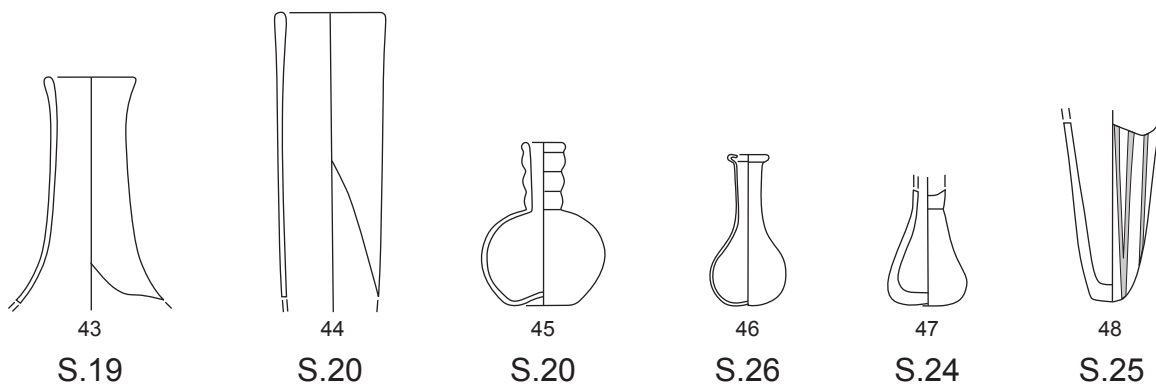

Camp Vermell (Sant Julià de Lòria-Andorra)

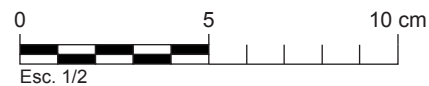
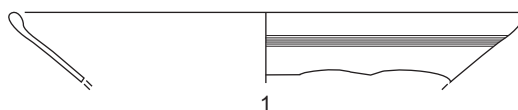

EL ROC D'ENCLAR (Santa Coloma), 1979-1993 i CAMP VERMELL (Sant Julià de Lòria)  
 Roc d'Enclar: Sepultures 19, 20, 24, 25 i 26 (Reelaborat a partir de D. FOY 1997)  
 Cronologia: s.V-X

LÀMINA 430