

TREBALL 2

***In vivo* modulation of 5-hydroxytryptamine release in mouse prefrontal cortex by local 5-HT_{2A} receptors: effect of antipsychotic drugs.**

Analía Bortolozzi, Mercè Amargós-Bosch, Albert Adell, Llorenç Díaz-Mataix, Jordi Serrats, Sebastià Pons i Francesc Artigas

European Journal of Neuroscience 18, 1235-1246 (2003).

Estudis precedents del nostre laboratori havien examinat com els receptors de serotonina 5-HT_{2A} de l'EPFm modulen el sistema serotoninèrgic en el cervell de rata (Martín-Ruiz *et al.*, 2001; treball 1 de la present tesi). Degut a la importància dels ratolins per l'existència de soques d'aquesta espècie nul·les per a diferents receptors de 5-HT, en aquest treball fem un estudi complet del control de l'alliberació de 5-HT en l'EPF mitjançada pel receptor 5-HT_{2A} (incloent estudis anatòmics de localització del receptor) en el cervell de ratolí. Tots els resultats presentats concorden amb els observats en rata.

També examinem com afecta la aplicació local d'antipsicòtics a l'increment en l'alliberació de 5-HT induïda pel DOI resultant en una reversió del l'efecte tant pels antipsicòtics clàssics com pels atípics.

In vivo modulation of 5-hydroxytryptamine release in mouse prefrontal cortex by local 5-HT_{2A} receptors: effect of antipsychotic drugs

Analía Bortolozzi, Mercè Amargós-Bosch, Albert Adell, Llorenç Díaz-Mataix, Jordi Serrats, Sebastià Pons and Francesc Artigas

Department of Neurochemistry, Institut d'Investigacions Biomèdiques de Barcelona (CSIC), IDIBAPS, 08036 Barcelona, Spain

Keywords: α_1 -adrenoceptors, AMPA receptors, glutamate, hallucinogens, 5-HT_{1A} receptors

Abstract

In the rat, postsynaptic 5-hydroxytryptamine_{2A} receptors medial prefrontal cortex control the activity of the serotonergic system through changes in the activity of pyramidal neurons projecting to the dorsal raphe nucleus. Here we extend these observations to mouse brain. The prefrontal cortex expresses abundant 5-hydroxytryptamine_{2A} receptors, as assessed by immunohistochemistry, Western blots and *in situ* hybridization procedures. The application of the 5-hydroxytryptamine_{2A/2C} agonist DOI (100 μ M) by reverse dialysis in the medial prefrontal cortex doubled the local release of 5-hydroxytryptamine. This effect was reversed by coprefusion of tetrodotoxin, and by the selective 5-hydroxytryptamine_{2A} receptor antagonist M100907, but not by the 5-hydroxytryptamine_{2C} antagonist SB-242084. The effect of DOI was also reversed by prazosin (α_1 -adrenoceptor antagonist), BAY \times 3702 (5-hydroxytryptamine_{1A} receptor agonist), NBQX (α -amino-3-hydroxy-5-methyl-4-isoxazole-4-propionate/kainic acid antagonist) and 1S,3S-ACPD (mGluR II/III agonist), but not by dizocilpine (*N*-methyl-D-aspartate antagonist). α -Amino-3-hydroxy-5-methyl-4-isoxazole-4-propionate mimicked the 5-hydroxytryptamine elevation produced by DOI, an effect also reversed by BAY \times 3702. Likewise, the coprefusion of classical (chlorpromazine, haloperidol) and atypical antipsychotic drugs (clozapine, olanzapine) fully reversed the 5-hydroxytryptamine elevation induced by DOI. These observations suggest that DOI increases 5-hydroxytryptamine release in the mouse medial prefrontal cortex through the activation of local 5-hydroxytryptamine_{2A} receptors by an impulse-dependent mechanism that involves/requires the activation of local α -amino-3-hydroxy-5-methyl-4-isoxazole-4-propionate receptors. This effect is reversed by ligands of receptors present in the medial prefrontal cortex, possibly in pyramidal neurons, which are involved in the action of antipsychotic drugs. In particular, the reversal by classical antipsychotics may involve blockade of α_1 -adrenoceptors, whereas that of atypical antipsychotics may involve 5-hydroxytryptamine_{2A} receptors and α_1 -adrenoceptors.

Introduction

Serotonin (5-hydroxytryptamine, 5-HT) acts on different pre- and postsynaptic receptors to modulate neural function (Barnes & Sharp, 1999). Serotonergic neurons participate in many physiological functions, and are involved in the pathophysiology and treatment of psychiatric disorders (Jacobs & Azmitia, 1992; Montgomery, 1994; Meltzer, 1999). Many higher brain functions reside in the prefrontal cortex (Fuster, 1997), and prefrontal abnormalities occur in certain psychiatric conditions, such as major depression and schizophrenia (Andreasen *et al.*, 1997; Drevets *et al.*, 1997).

5-HT_{2A} receptors are predominantly located in the neocortex, with a large density in the prefrontal cortex (Pazos *et al.*, 1985; Pompeiano *et al.*, 1994), which suggests an involvement in higher brain functions, such as working memory (Williams *et al.*, 2002). Moreover, 5-HT_{2A} receptor agonists, such as LSD or 1-[2,5-dimethoxy-4-iodophenyl-2-aminopropane] (DOI) are hallucinogens, whereas atypical antipsychotic drugs and some antidepressant drugs (e.g. nefazodone, trazodone) possibly exert their therapeutic action partly through the blockade of

5-HT_{2A} receptors (Titeler *et al.*, 1988; Kroeze & Roth, 1998; Meltzer, 1999).

In the rat, prefrontal 5-HT_{2A} receptors are located on pyramidal neurons and, to a lower proportion, in γ -aminobutyric acidergic (GABAergic) interneurons (Willins *et al.*, 1997; Jakab & Goldman-Rakic, 1998; Jakab & Goldman-Rakic, 2000; Cornea-Hebert *et al.*, 1999). The axons of layer V pyramidal neurons constitute the main output of the prefrontal cortex and project to many subcortical regions, including the brainstem aminergic nuclei (Aghajanian & Wang, 1977; Thierry *et al.*, 1983; Sesack *et al.*, 1989; Takagishi & Chiba, 1991; Sesack & Pickel, 1992; Hajós *et al.*, 1998; Jodo *et al.*, 1998; Peyron *et al.*, 1998; Au-Young *et al.*, 1999). Consistently with these anatomical relationships, it has been shown that the medial prefrontal cortex (mPFC) of the rat controls the activity of midbrain serotonergic neurons (Hajós *et al.*, 1998; Celada *et al.*, 2001; Martín-Ruiz *et al.*, 2001). In particular, the stimulation of prefrontal 5-HT_{2A} receptors by the 5-HT_{2A/2C} agonist DOI increased serotonergic firing rate in the dorsal raphe nucleus (DR) and 5-HT release in mPFC by a 5-HT_{2A}-dependent mechanism (Martín-Ruiz *et al.*, 2001). These effects are mediated by an activation of pyramidal neurons in mPFC (Puig *et al.*, 2003) and involve α -amino-3-hydroxy-5-methyl-4-isoxazole-4-propionate (AMPA)-mediated glutamatergic inputs (Martín-Ruiz *et al.*,

Correspondence: Dr F. Artigas, as above.
E-mail: fapnqi@iibb.csic.es

Received 10 June 2003, accepted 17 June 2003

doi:10.1046/j.1460-9568.2003.02829.x

2001; Puig *et al.*, 2003), as also observed for the 5-HT-elicited, 5-HT_{2A}-mediated excitation of layer V pyramidal neurons (Aghajanian & Marek, 1997; Aghajanian & Marek, 1999; Aghajanian & Marek, 2000).

The above experiments have been conducted in rat brain. However, it is not known whether the same chain of events takes place in other mammalian species. Because of the interest of murine transgenic models to investigate the mechanism of action of psychotropic drugs, in the present study we extended our observations to mouse brain, also examining the effect of antipsychotic drugs on the stimulatory action of DOI. These drugs are used for the treatment of schizophrenia and treatment-resistant depression (Kroeze & Roth, 1998; Ostroff & Nelson, 1999; Shelton *et al.*, 2001; Marangell *et al.*, 2002), and show high affinity for receptors present in pyramidal neurons, such as 5-HT_{2A} and α_1 -adrenoceptors (Sebban *et al.*, 1999; Arnt & Skarsfeldt, 1998; Bymaster *et al.*, 1999a, b).

Materials and methods

Animals

C57BL/6 adult male mice (Iffa Credo, Lyon, France) weighing 22–28 g at the time of experiments were kept in a controlled environment (12 h light : dark cycle and 22 ± 2 °C room temperature) with food and water provided *ad libitum*. Animal procedures were approved by a local Ethical Committee and care followed the European Union regulations (O.J. of E.C. L358/1 18/12/1986).

Drugs and reagents

5-HT oxalate (S)-AMPA, chlorpromazine, DOI, dizocilpine [(+) MK-801], 2,3-dihydroxy-6-nitro-7-sulphamoyl-benzo(f)quinoxaline (NBQX), 6-chloro-5-methyl-1-[6-(2-methylpyridin-3-yloxy) pyridin-3-yl carbamoyl] indoline (SB 242084), prazosin and tetrodotoxin (TTX) were from Sigma/RBI (Natick, MA, USA). 1S,3S-Aminocyclopentane dicarboxylic acid (1S,3S-ACPD), haloperidol and clozapine were from Tocris (Bristol, UK). *R*-(-)-2-[4-[(chroman-2-ylmethyl)-amino]-butyl]-1,1-dioxo-benzo[d]isothiazolone-HCl (BAY \times 3702), citalopram-HBr, *R*-(+)- α -(2,3-dimethoxyphenyl)-1-[4-fluorophenylethyl]-4-piperidinemethanol (M100907) (Lilly code LY 368675) and olanzapine were from Bayer AG, H. Lundbeck A/S and Eli Lilly, respectively. Other materials and reagents were from local commercial sources. For the assessment of local effects, drugs were dissolved in the perfusion fluid or water (except clozapine, dissolved in acetic acid, and olanzapine, dissolved in HCl), and diluted to appropriate concentrations in artificial cerebrospinal fluid (aCSF). Concentrated solutions (1 mM; pH adjusted to 6.5–7 with NaHCO₃ when necessary) were stored at –80 °C and working solutions were prepared daily by dilution in aCSF. Concentrations are expressed as free bases. Control mice were perfused for the entire experiment with aCSF. The bars in the figures show the period of drug application (corrected for the void volume of the system).

Surgery and microdialysis procedures

The microdialysis procedures were adapted from those previously described for rats (Adell & Artigas, 1998). Thus, the shaft of the concentric dialysis probes was made up of 15-mm-long, 25-gauge (0.51 mm OD, 0.30 mm ID) stainless-steel tubing (A-M systems, Carlsborg, WA, USA). The inflow and outflow tubes threaded through the 25-gauge tubing consisted of fused silica capillary tubing of 0.11 mm OD and 0.04 mm ID (Polymicro Technologies, Phoenix, AZ, USA). The upper exposed ends of silica tubings were inserted into 7-mm-long, 27-gauge (0.41 mm OD, 0.20 mm ID) stainless-steel tubing. The probes were secured to the skull with dental cement and

two 2-mm-long, 0.95-mm \varnothing screws (Microbiotech/se AB, Stockholm, Sweden). Anaesthetized mice [pentobarbital, 40 mg/kg intraperitoneally (i.p.)] were stereotaxically implanted with one concentric microdialysis probe equipped with a Cuprophan membrane in the mPFC (AP +2.2, L –0.2, DV –3.4; probe tip: 2 mm) (coordinates in mm taken from bregma and top of skull; Franklin & Paxinos, 1997). Microdialysis experiments were performed on the following day in freely moving mice. The probes were perfused at 1.5 μ L/min with aCSF (in mM: NaCl, 125; KCl, 2.5; CaCl₂, 1.26; MgCl₂, 1.18; containing 1 μ M citalopram. After 100-min stabilization period, four fractions were collected to obtain basal values before local (reverse dialysis) administration of drugs. Successive 20-min (30 μ L) dialysate samples were collected. In most experiments, the partial 5-HT_{2A/2C} receptor agonist DOI was applied alone for 2 h (six fractions), followed by its application together with other drugs for another 2-h period. At the end of experiments, mice were killed by an overdose of pentobarbital, brains were removed and the correct location of probes was checked by visual inspection after perfusing a dye through the microdialysis probe. In some cases, mice were perfused transcardially with 0.1 M phosphate-buffered saline (PBS), and coronal sections (50 μ m) were cut at the mPFC level and stained with Neutral red (Fig. 1).

The concentration of 5-HT in dialysate samples was determined by high-performance liquid chromatography (HPLC), as described (Adell & Artigas, 1998). 5-HT was separated using a Beckman (San Ramon, CA, USA) 3- μ m particle size column and detected with a Hewlett-Packard 1049 electrochemical detector at +0.6 V. Retention time was between 3.5 and 4 min, and the limit of detection was typically 1 fmol/sample.



FIG. 1. Localization of the microdialysis probe in the mouse medial prefrontal cortex. Coronal section of a mouse brain at approximately bregma +2.2 mm showing the track left by the probe (arrowheads).

Immunohistochemistry

Adult mice were anaesthetized with pentobarbital and transcardially perfused with 0.1 M PBS, followed by cold 4% paraformaldehyde in 0.1 M PBS, pH 7.4. Brains were immediately dissected and fixed by immersion in the same fixative solution for 6 h at 4 °C. Transverse serial sections (50 µm thick) of prefrontal cortex were cut and collected in PBS containing 0.1% Triton X-100 for free-floating immunostaining with the different antibodies. Sections were washed in PBS containing 0.1% Triton X-100 and 0.1% bovine serum albumin, and incubated with the primary antibody (mouse anti-5HT_{2A}, 1 : 1000, Pharmingen, San Diego, CA, USA) overnight at 4 °C. Sections were then washed in PBS and incubated for 1 h at room temperature with antimouse conjugated to Alexa-594 (Molecular Probes). The bound antibody was visualized with a confocal microscope.

Western blotting

Immunoblots were performed as previously described (Pons *et al.*, 1995). Briefly, prefrontal cortices were dissected out and homogenized in NaCl, 150 mM; Tris-HCl, 20 mM, pH 7.4; NP40, 1%; aprotinin, 1 µg/mL; leupeptin, 1 µg/mL; and phenylmethylsulphonyl fluoride (PMSF), 1 mM; using 15 mL of buffer per gram of tissue. Insoluble material was removed by centrifugation, and 75 µg of protein per lane of the supernatants were separated by sodium dodecyl sulphate-polyacrylamide gel electrophoresis (SDS-PAGE) and transferred to nitro-cellulose membranes. After blocking for 1 h with 8% fat-free dry milk in TTBS (Tris-HCl, 20 mM, pH 7.4; NaCl, 150 mM; 0.1% Tween-20), membranes were incubated overnight with the different antibodies in TTBS, washed and incubated with protein A-HRP (Pierce, Cultek, Madrid, Spain), and finally developed with the ECL-R reaction (Amersham).

In situ hybridization studies

Tissue sections, 14 µm thick, were cut using a microtome-cryostat (HM500-OM Microm, Walldorf, Germany), thaw-mounted onto 3-aminopropyltriethoxysilane (APTS; Sigma, St. Louis, MO, USA)-coated slides, and kept at -20 °C until use. Different oligonucleotides were used to detect 5-HT_{2A} receptor messenger ribonucleic acid (mRNA) in rat brain (Pompeiano *et al.*, 1994). We used three oligonucleotides complementary to the mRNA coding for the 5-HT_{2A} receptor, corresponding to the amino terminus (bases 669–716), third cytoplasmic loop (bases 1882–1520) and carboxy terminus (bases 1913–60) (Pritchett *et al.*, 1988). Probes were synthesized on a 380 Applied Biosystem DNA synthesizer (Foster City Biosystem, Foster City, CA, USA) and purified on a 20% polyacrylamide/8 M urea preparative sequencing gel. Each 5-HT_{2A} receptor oligodeoxyribonucleotide (2 pmol) was individually labelled at its 3'-end with [³³P]α-dATP (>3000 Ci/mmol, Amersham Pharmacia Biotech, Little Chalfont, UK) using terminal deoxynucleotidyltransferase (TdT, Roche Diagnostics GmbH, Mannheim, Germany). Labelled probes were purified through QIAquick Nucleotide Removal columns (QIAGEN GmbH, Hilden, Germany).

In situ hybridization histochemistry was performed as described (Tomiya *et al.*, 1997) For hybridization, the radioactively labelled probes were pooled at final individual concentrations of approximately 1.5 nM. Sections were dipped into Ilford K5 nuclear track emulsion (Ilford, Moberly, UK), exposed in the dark at 4 °C for 6 weeks, and finally developed. Tissue sections were examined in a Wild 420 microscope (Leica, Heerbrugg, Germany) and in a Nikon Eclipse E1000 microscope (Nikon, Tokyo, Japan) equipped with bright- and dark-field condensers for transmitted light. Micrography was performed using a digital camera (DXM1200 3.0, Nikon) and analySIS Software (Soft Imaging System GmbH, Münster, Germany).

Data and statistical analysis

Data (mean ± SEM) are expressed as fmol/fraction (uncorrected for recovery) and shown in figures as percentages of basal values, averaged from four predrug fractions. Statistical analysis of drug effects on dialysate 5-HT was performed using analysis of variance (ANOVA) for repeated measures of raw data, with time as repeated factor and concentration as independent factor. The effect of DOI was compared with basal values, whereas that of DOI + drugs was compared with DOI alone. Statistical significance has been set at the 95% confidence level (two-tailed).

Results

Histological localization of 5-HT_{2A} receptors and 5-HT_{2A} receptor mRNA in the mPFC of the mouse

Given the absence of reports on the cellular localization of 5-HT_{2A} receptors in the mPFC of the mouse, we studied their distribution by immunohistochemical labelling using a commercial antibody raised against the 5-HT_{2A} receptor. Figure 2A shows the presence of abundant large immunopositive cells in the mouse mPFC. Western blots from prefrontal cortex tissue showed a band at the expected molecular weight (52 kDa) labelled with the same antibody used in immunohistochemical analyses (Fig. 2B).

We also used *in situ* hybridization to label 5-HT_{2A} mRNA-expressing cells in the mPFC of the mouse. Figure 3 shows dark-field photomicrographs of a coronal section of the mouse cortex at an AP level similar to that where dialysis probes were placed. A large number of cells were detected that expressed the 5-HT_{2A} receptor mRNA in superficial, middle and internal layers of the prefrontal cortex. Likewise, many cells expressing the 5-HT_{2A} receptor transcript were also evident in the cingulate and prelimbic areas (Fig. 3B and C).

Effect of DOI on 5-HT output in mPFC

Baseline 5-HT values in dialysate samples from mPFC were 15.2 ± 0.7 fmol/fraction (*n* = 117). The perfusion of aCSF did not significantly alter the 5-HT output. The perfusion of DOI from 30 to 300 µM increased the 5-HT output in a concentration-dependent manner (Fig. 4A). 5-HT raised from 9.0 ± 1.9 fmol/fraction (baseline) to a maximum of 25.7 ± 4.9 fmol/fraction at 300 µM, decreasing to 18.2 ± 3.4 fmol/fraction at 500 µM. One-way repeated measures ANOVA conducted with the averaged 5-HT values at each concentration indicated a significant effect of DOI ($F_{4,16} = 11.9$, $P < 0.00015$). Post-hoc Duncan's test revealed a significant difference between the concentrations of 100, 300 and 500 µM vs. baseline and a significant difference between the effects of 300 and 500 µM (Fig. 4A). In an additional experiment, we examined the effects of these different DOI concentrations perfused increasingly in the same animals. The mean 5-HT elevations, expressed as percent of baseline, were 176 ± 9% (100 µM, *n* = 11), 227 ± 18% (300 µM, *n* = 4) and 187 ± 5% (500 µM, *n* = 6). One-way ANOVA revealed a significant effect of the concentration ($F_{2,18} = 5.28$), with post-hoc significant differences between 300 µM and the other two concentrations used (Duncan test) (Fig. 4B). From these data we chose the concentration of 100 µM for subsequent experiments.

The local application of 100 µM DOI in mPFC of mice resulted in an increase of the 5-HT output that persisted for all the perfusion time ($F_{15,150} = 13.36$, $P < 0.000001$; one-way repeated measures ANOVA). In a subgroup of four rats, the infusion of DOI was followed by coperfusion of 1 µM TTX. This resulted in a dramatic fall of the 5-HT output, reaching 31 ± 3% of baseline ($F_{3,27} = 7.67$, $P < 0.00002$) (Fig. 5).

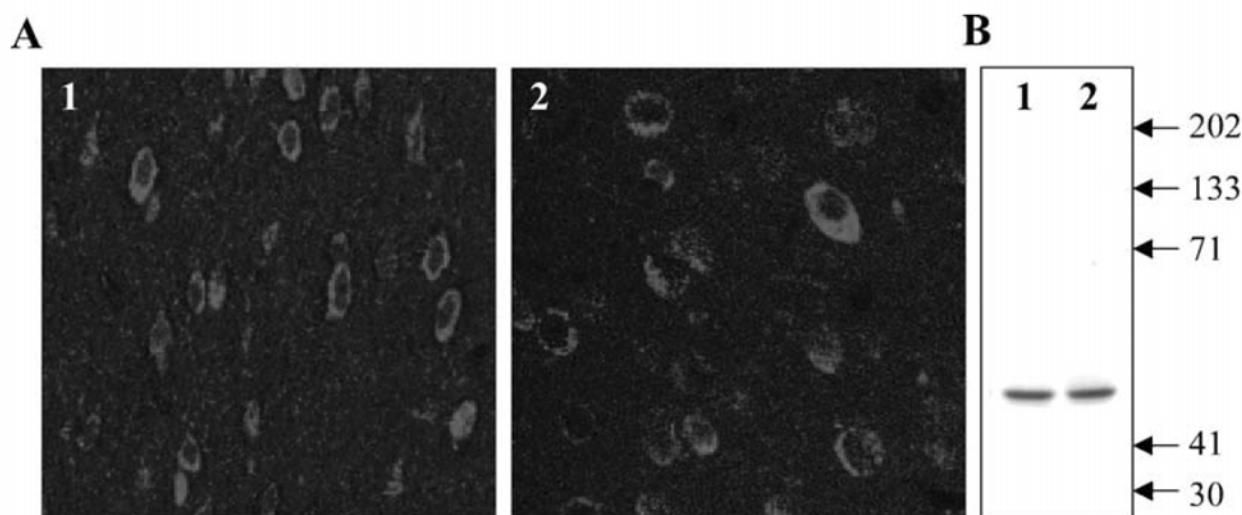

FIG. 2. Expression of 5-HT_{2A} receptor in mouse prefrontal cortex. The expression of 5-HT_{2A} receptor in murine prefrontal cortex was estimated using immunohistochemistry (A1 and A2) and Western blot (B) approaches. The prefrontal cortices of two adult mice were dissected and the tissue was sliced as described in Materials and methods. Representative pictures of each animal show abundant prefrontal neurons stained with 5-HT_{2A} antibodies and developed with antimouse-Alexa 594 (A1 and A2). (B, lanes 1 and 2) The expression of 5-HT_{2A} receptor in homogenates of prefrontal cortex from two different animals. The Western blot was performed using the same antibody as in A and developed with antimouse peroxidase and enhanced chemiluminescence reaction. The expected molecular weight of the receptor is 52 kDa. Scale bar, 50 μ m.

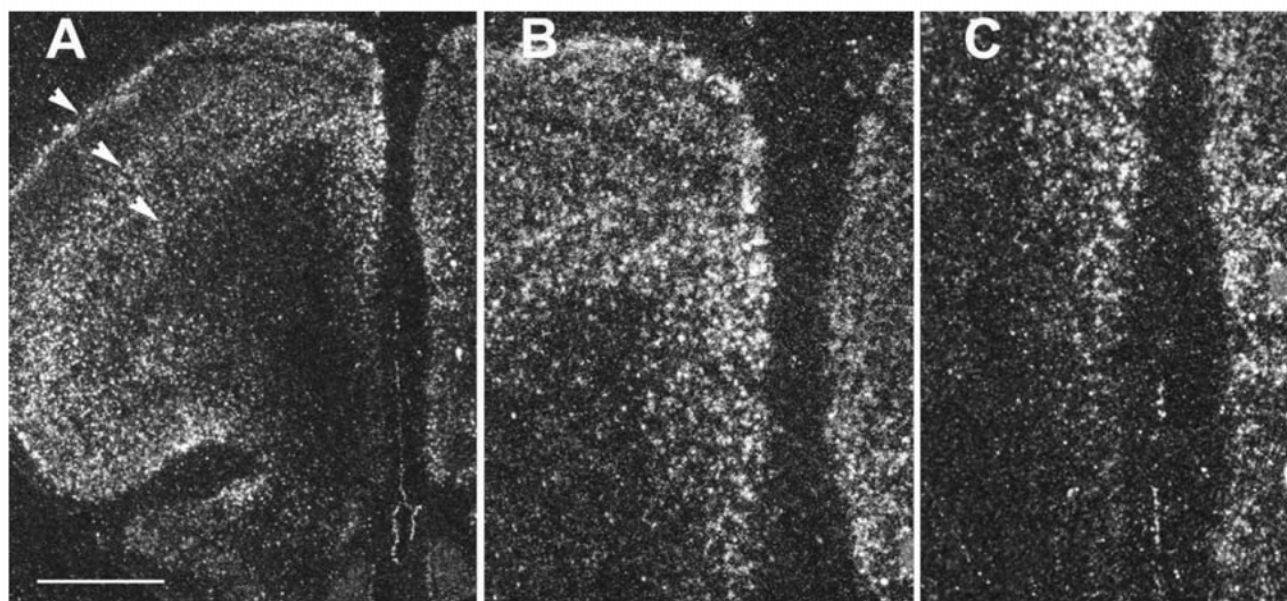

FIG. 3. (A) Low-level magnification dark-field photomicrographs of 5-HT_{2A} receptor mRNA in the mouse prefrontal cortex. 5-HT_{2A} receptor mRNA was detected using ³³P-labelled oligonucleotides (see text). Note the distribution of cells expressing the receptor in superficial, intermediate and internal cortical layers (arrowheads). (B and C) Enlargements of the cingulate, prelimbic areas (B) and infralimbic (C) areas of the prefrontal cortex. Scale bar, 1 mm (A); 400 μ m (B and C).

Pharmacological characterization

The perfusion of the selective 5-HT_{2A} antagonist M100907 (100 μ M) elicited a partial but significant reversal of the 5-HT increase induced by DOI ($F_{9,54} = 3.37$, $P < 0.025$, one-way repeated measures ANOVA of fractions 7–16, i.e. four fractions with stable DOI effect plus all DOI + M100907 fractions) (Fig. 6A). A greater M100907 concentration (300 μ M) completely reversed the 5-HT elevation induced by 100 μ M DOI ($F_{9,36} = 8.66$, $P < 0.000001$). In contrast, the effect of

DOI was unaltered by the coprefusion of the selective 5-HT_{2C} receptor antagonist SB-242084 (100 μ M), as seen in Fig. 6B.

The 5-HT elevation induced by DOI was completely reversed by the coapplication of the α_1 -adrenoceptor antagonist prazosin (100 μ M, $n = 5$). One-way repeated measures ANOVA of fractions 7–16 showed a significant effect of prazosin on 5-HT values ($F_{9,36} = 7.17$, $P < 0.000007$) (Fig. 7). Similarly, the application of the selective 5-HT_{1A} receptor agonist BAY \times 3702 (30 μ M, $n = 8$) fully reversed the 5-HT elevation induced by DOI ($F_{9,63} = 14.14$, $P < 0.000001$) (Fig. 8).

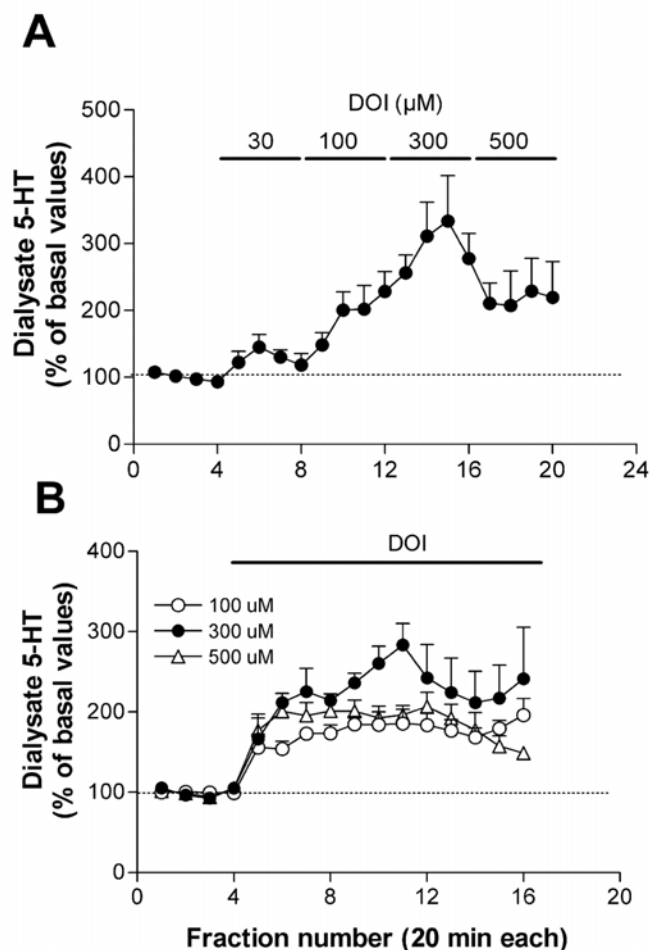

FIG. 4. (A) Effect of the local perfusion of the 5-hydroxytryptamine_{2A/2C} (5-HT_{2A/2C}) agonist 1-[2,5-dimethoxy-4-iodophenyl-2-aminopropane] (DOI) on the 5-HT output in the mPFC of the freely moving mice. DOI was perfused at increasing concentrations (30–500 μM, four fractions each; shown by horizontal bars). The maximal elevation was noted at 300 μM. Data from five mice. (B) Effect of the local perfusion of DOI (100, 300 and 500 μM) for 12 fractions. Data from 11, four and six rats, respectively. As in (A), the maximal effect of DOI was noted at 300 μM. See text for statistical analysis.

Previous work in the mPFC of the rat showed that the 5-HT-increasing effect of DOI was counteracted by NBQX [AMPA/kainic acid (KA) receptor antagonist], 1S,3S-ACPD (mGluR II/III agonist) and mimicked by AMPA application (Martín-Ruiz *et al.*, 2001). We therefore examined whether glutamatergic mechanisms were also involved in the action of DOI in the mPFC of the freely moving mouse. The application of the AMPA/KA receptor antagonist NBQX (300 μM) markedly attenuated the 5-HT increase induced by DOI application in mPFC ($F_{9,36} = 5.55$, $P < 0.00009$; Fig. 9A). However, the application of the *N*-methyl-D-aspartate (NMDA) receptor antagonist MK-801 (300 μM) did not alter significantly the effect of DOI (Fig. 9B). The application of the mGluR II/III agonist 1S,3S-ACPD at 3 mM also counteracted in a significant manner the effect of DOI ($F_{9,36} = 4.04$, $P < 0.0015$), although the antagonism was not complete (Fig. 9C). A lower concentration of 1S,3S-ACPD (1 mM) caused only a minor, nonsignificant (15–20%) reduction of the effect of DOI (data not shown).

The effect of DOI was also mimicked by the application of AMPA (300 μM). AMPA induced a sustained increase of dialysate 5-HT

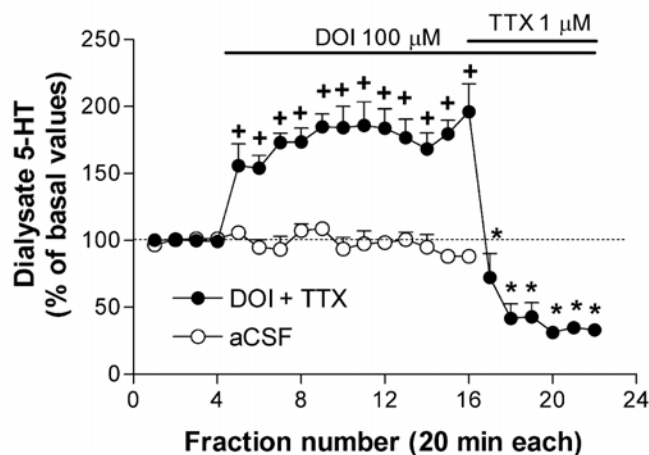

FIG. 5. The local perfusion of 1-[2,5-dimethoxy-4-iodophenyl-2-aminopropane] (DOI) 100 μM induced a sustained increase in 5-hydroxytryptamine (5-HT) output that remained stable for at least 4 h ($n = 11$; filled circles). In a subgroup of four mice, the subsequent addition of 1 μM tetrodotoxin (TTX) abolished the effect of DOI and reduced 5-HT values to 31% of baseline. Shown also is the effect of the continuous perfusion of artificial cerebrospinal fluid (aCSF, $n = 6$; open circles). The period of drug application is shown by horizontal bars. $^+P < 0.05$ vs. baseline; $^*P < 0.05$ vs. DOI alone (Duncan's test postANOVA).

that reached $282 \pm 30\%$ of baseline at the end of the experiment ($F_{15,75} = 12.58$, $P < 0.000001$) (Fig. 10). The effect of AMPA on 5-HT output was also reversed by the coapplication of 30 μM BAY × 3702 ($F_{9,36} = 8.33$, $P < 0.000001$; ANOVA of fractions 7–16) (Fig. 10).

Effect of antipsychotic drugs

The above observations indicated that the DOI-stimulated 5-HT release in mouse mPFC was reversed by compounds that share some characteristics with classical and/or atypical antipsychotics, i.e. 5-HT_{2A} receptor antagonists, α₁-adrenoceptor antagonists and 5-HT_{1A} receptor agonists. We therefore examined the effect of the local application of the atypical antipsychotics clozapine and olanzapine on the DOI-stimulated 5-HT release. Both agents (300 μM each) completely reversed the increase in 5-HT elicited by DOI ($F_{9,90} = 16.65$, $P < 0.000001$ and $F_{9,45} = 8.58$, $P < 0.000001$, respectively) (Fig. 11A). Likewise, the classical antipsychotic drugs chlorpromazine and haloperidol also reversed the 5-HT elevation induced by DOI at the same concentration as the atypical antipsychotics (300 μM). Repeated measures ANOVA showed a significant effect of haloperidol ($F_{9,27} = 13.91$, $P < 0.000001$) and chlorpromazine ($F_{9,36} = 14.96$, $P < 0.000001$) (Fig. 11B).

Discussion

The present results confirm and extend previous observations in rat brain to the mouse brain, showing that the application of the partial 5-HT_{2A/2C} agonist DOI in mPFC enhanced the local 5-HT release. We also show that this effect is reversed by the α₁-adrenoceptor antagonist prazosin and by antipsychotic drugs, either classical (chlorpromazine, haloperidol) or atypical (clozapine and olanzapine).

Localization of 5-HT_{2A} receptors in mouse prefrontal cortex

In the rat prefrontal cortex, 5-HT_{2A} receptors occur in pyramidal neurons, GABAergic interneurons and nerve terminals (Jakab & Goldman-Rakic, 1998; Miner *et al.*, 2003). The latter (much smaller)

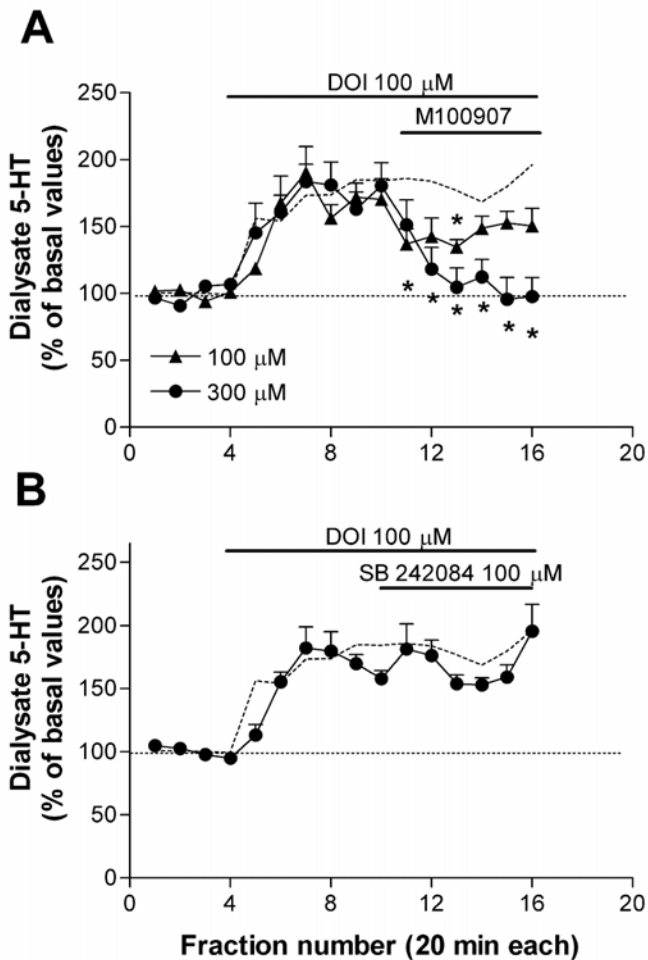

FIG. 6. The increase in 5-hydroxytryptamine (5-HT) output elicited by 1-[2,5-dimethoxy-4-iodophenyl-2-aminopropane] (DOI) was reversed by the simultaneous application of the selective 5-HT_{2A} receptor antagonist M100907 [100 and 300 μM ; $n = 7$ and 5, respectively, (A)] but not by the selective 5-HT_{2C} receptor antagonist (6-chloro-5-methyl-1-[6-(2-methylpyridin-3-yloxy) pyridin-3-yl carbamoyl] indoline) [SB-242084, 100 μM ; $n = 8$, (B)]. The period of drug application is shown by horizontal bars. * $P < 0.05$ vs. DOI alone (Duncan's test postANOVA). For clarity's sake, the significance of the time points during the perfusion of DOI alone is not shown. The dotted line shows the effect of DOI alone.

population is unlikely to represent 5-HT nerve terminals as 5-HT neurons do not express 5-HT_{2A} receptors (Pompeiano *et al.*, 1994; Fay & Kubin, 2000). The dialysis probes were implanted in a prefrontal area rich in 5-HT_{2A} receptors, as assessed by autoradiography (López-Giménez *et al.*, 2002). The present immunohistochemical observations indicate the existence of abundant cells expressing this receptor in limbic areas of the mouse prefrontal cortex. 5-HT_{2A} receptors are located on the membrane of large cells (possibly pyramidal neurons), whereas the amount of labelling in cell processes was low using the present immunohistochemical procedure. Likewise, the results obtained with the technique of *in situ* hybridization show the presence of a large number of cells expressing the 5-HT_{2A} receptor mRNA in superficial, middle and deep layers of the mouse prefrontal cortex. In the mPFC, large numbers of cells in the cingulate and prelimbic areas were seen, with a somewhat lesser abundance in the infralimbic cortex. Additional studies are required to ascertain whether 5-HT_{2A} receptors

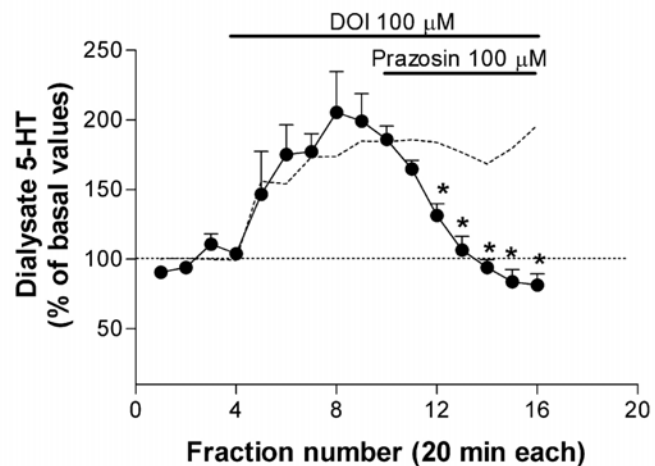

FIG. 7. Reversal of the effect of 1-[2,5-dimethoxy-4-iodophenyl-2-aminopropane] (DOI) on 5-hydroxytryptamine (5-HT) release by the α_1 -adrenoceptor antagonist prazosin (100 μM ; $n = 5$). The period of drug application is shown by horizontal bars. * $P < 0.05$ vs. DOI alone (Duncan's test postANOVA). For clarity's sake, the significance of the time points during the perfusion of DOI alone is not shown. The dotted line shows the effect of DOI alone.

are expressed in GABA interneurons, as observed in rat brain (Willins *et al.*, 1997).

Involvement of 5-HT_{2A} receptors in the effect of DOI

The activation of 5-HT_{2A} receptors in prefrontal cortex has been shown to increase and decrease the excitability of presumed or identified pyramidal neurons (Ashby *et al.*, 1990; Araneda & Andrade, 1991; Ashby *et al.*, 1994; Aghajanian & Marek, 1997; Zhou & Hablitz, 1999). Excitatory effects of 5-HT or DOI likely reflect a direct action on pyramidal 5-HT_{2A} receptors, whereas inhibitory effects may involve GABA interneurons (Aghajanian & Marek, 1997; Zhou & Hablitz, 1999). Our own data in anaesthetized rats indicate that the systemic administration of DOI elicits both 5-HT_{2A} receptor-mediated

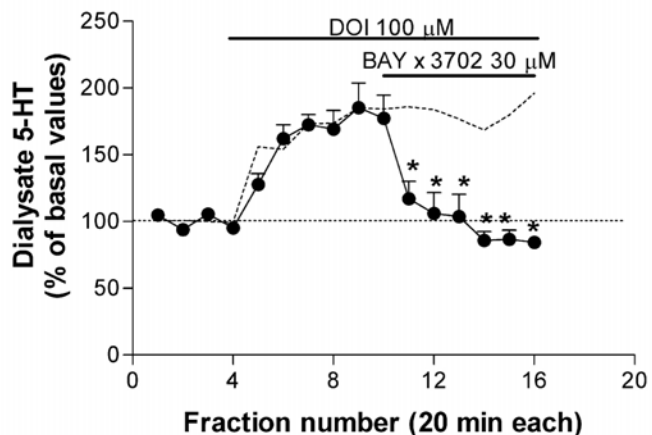

FIG. 8. The selective 5-hydroxytryptamine_{1A} (5-HT_{1A}) receptor agonist [R(-)-2-[4-[(chroman-2-ylmethyl)-amino]-butyl]-1,1-dioxo-benzod[isothiazolo]ne-HCl] (BAY x 3702, 30 μM ; $n = 8$) completely reversed the 5-HT elevation induced by 1-[2,5-dimethoxy-4-iodophenyl-2-aminopropane] (DOI). The period of drug application is shown by horizontal bars. * $P < 0.05$ vs. DOI alone (Duncan's test postANOVA). For clarity's sake, the significance of the time points during the perfusion of DOI alone is not shown. The dotted line shows the effect of DOI alone.

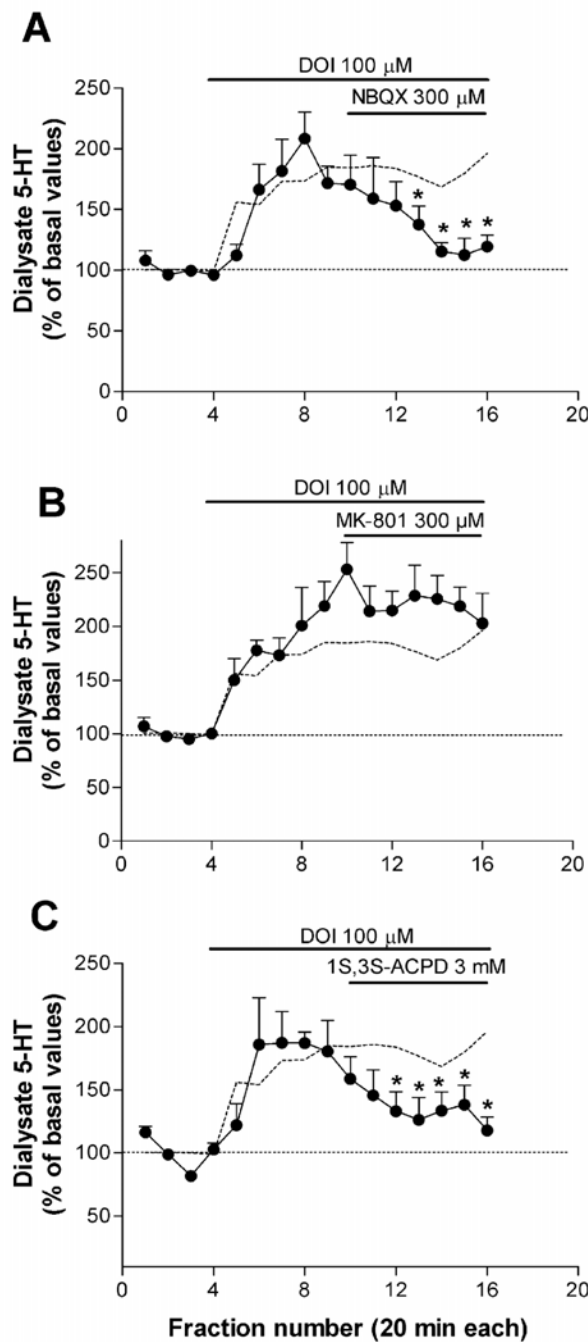

FIG. 9. Involvement of the AMPA-mediated glutamatergic transmission in the effect of 1-[2,5-dimethoxy-4-iodophenyl]-2-aminopropane (DOI). The 5-hydroxytryptamine (5-HT) elevation induced by the local application of DOI was reversed by the coperfusion of the AMPA/KA antagonist (2,3-dihydroxy-6-nitro-7-sulphamoyl-benzo(f)quinoxaline) (NBQX, 300 μ M; $n = 5$) (A), but not by the coperfusion of the NMDA receptor antagonist dizocilpine (MK-801, 300 μ M; $n = 5$) (B). The mGluR II/III receptor agonist (1S,3S-aminocyclopentane dicarboxylic acid) (1S,3S-ACPD, 3 mM; $n = 5$) also reversed the 5-HT elevation induced by DOI (C). The period of drug application is shown by horizontal bars. * $P < 0.05$ vs. DOI alone (Duncan's test postANOVA). For clarity's sake, the significance of the time points during the perfusion of DOI alone is not shown. The dotted line shows the effect of DOI alone.

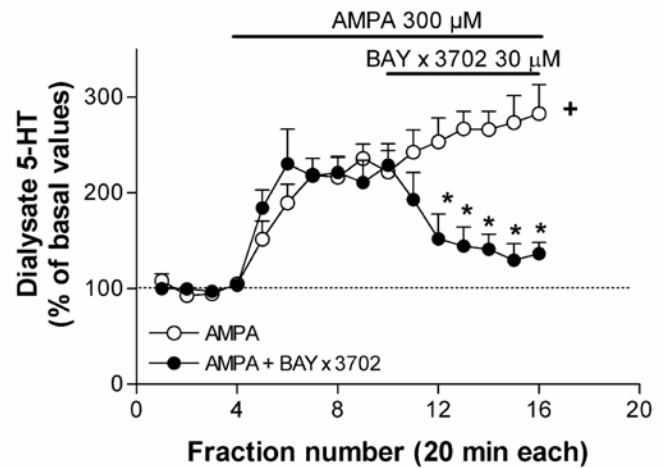

FIG. 10. The local application of α -amino-3-hydroxy-5-methyl-4-isoxazole-4-propionate (AMPA, 300 μ M, $n = 6$) elevated the 5-hydroxytryptamine (5-HT) output in mPFC to an extent similar to that produced by DOI. In another group of mice, the effect of AMPA was reversed by the subsequent application of the selective 5-HT_{1A} receptor agonist {R(-)-2-[4-[(chroman-2-ylmethyl)-amino]-butyl]-1,1-dioxo-benzo[d]isothiazolone-HCl} (BAY x 3702, 30 μ M; $n = 5$). The period of drug application is shown by horizontal bars. +Fractions 5–16 significantly different from baseline ($P < 0.05$, Duncan's test postANOVA); * $P < 0.05$ vs. AMPA alone (Duncan's test postANOVA).

excitations and inhibitions of pyramidal neurons in mPFC, with an overall 240% increase in their firing rate (Puig *et al.*, 2003). This predominance of an excitatory action *in vivo* is consistent with the increase in serotonergic firing rate observed after the local application of DOI in rat mPFC (Martín-Ruiz *et al.*, 2001; Puig *et al.*, 2003). Indeed, although the microdialysis approach does not allow to discern which receptor subset mediates the action of DOI on 5-HT release, the greater proportion of 5-HT_{2A} receptors in pyramidal neurons, compared with GABAergic cells (Santana *et al.*, in preparation), and the overall excitatory action of DOI on pyramidal cell firing *in vivo* suggest that the action on pyramidal 5-HT_{2A} receptors overcomes that in GABAergic cells. Thus, despite the lack of tracing studies in mouse brain reporting a mPFC–DR connectivity, by analogy with rat brain, we suggest that the effect of DOI on 5-HT release in mouse mPFC is due to the activation of a 5-HT_{2A}-containing subpopulation of neurons in mPFC that project to ascending 5-HT neurons.

Pyramidal neurons in mPFC control the activity of DR 5-HT neurons in a complex manner. Both direct excitatory (Celada *et al.*, 2001) and GABA-mediated inhibitory influences have been reported (Celada *et al.*, 2001; Varga *et al.*, 2001). Pyramidal cells in the rat mPFC that express 5-HT_{2A} receptors project to the DR, as indicated by the presence of orthodromic and antidromic pyramidal spikes after the electrical stimulation of the DR (Puig *et al.*, 2003). However, it is not known whether the excitatory axons of 5-HT_{2A}-expressing pyramidal neurons (likely a subpopulation of all neurons in mPFC) synapse on 5-HT or on GABA neurons in midbrain. The local application of DOI in rat mPFC increases DR 5-HT cell firing and terminal 5-HT release (Martín-Ruiz *et al.*, 2001; Puig *et al.*, 2003; this study). Likewise, the increase of AMPA-mediated neurotransmission in mPFC by various means (local application of S-AMPA, inhibition of glutamate reuptake, disinhibition of thalamic afferents to mPFC) increases pyramidal cell firing and terminal 5-HT release (Martín-Ruiz *et al.*, 2001; Puig *et al.*, 2003). Conversely, the local application of 5-HT_{1A} agonists in mPFC reduces local 5-HT release and 5-HT cell firing in the DR (Casanovas *et al.*, 1999; Celada *et al.*, 2001), and the ability of 8-OH-DPAT to suppress 5-HT cell firing is reduced by removal of the mPFC and

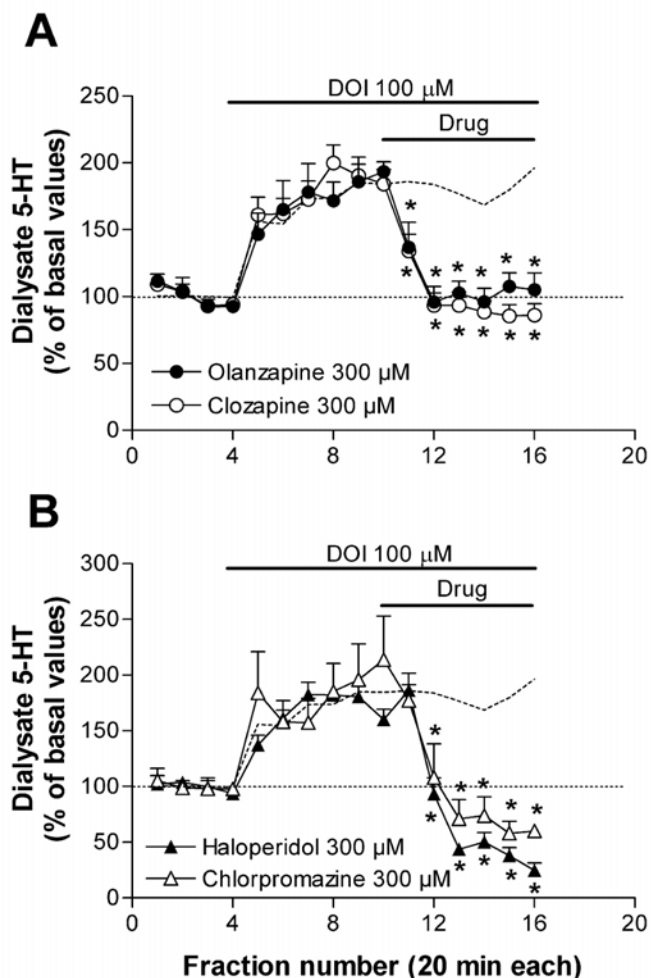

FIG. 11. (A) The local application of the atypical antipsychotics clozapine (open circles; $n = 11$) and olanzapine (filled circles; $n = 6$) (300 μ M each) completely reversed the 5-hydroxytryptamine (5-HT) elevation induced by 1-[2,5-dimethoxy-4-iodophenyl-2-aminopropane] (DOI). (B) Likewise, the classical antipsychotics chlorpromazine (open triangles; $n = 5$) and haloperidol (filled triangles; $n = 4$) fully reversed the effect of DOI. The period of drug application is shown by horizontal bars. * $P < 0.05$ vs. DOI alone (Duncan's test postANOVA). For clarity's sake, the significance of the time points during the perfusion of DOI alone is not shown. The dotted line shows the effect of DOI alone.

cortical transection (Ceci *et al.*, 1994; Hajós *et al.*, 1999). Together, these observations suggest an overall excitatory influence of prefrontal neurons expressing 5-HT_{2A} and 5-HT_{1A} receptors on serotonergic activity, yet the electrical stimulation of the bulk of mPFC neurons may elicit GABA-mediated inhibitions on DR 5-HT neurons. The scheme in Fig. 12 summarizes the anatomical and functional relationships between the mPFC and the DR and the main receptors/transmitters putatively involved. However, despite the present and previous data accord with an effect of DOI on 5-HT release via long loops, a local action may also be accountable (see below).

In mice, the magnitude of the effect of 100 μ M DOI was similar to that observed in rat mPFC at the same concentration (Martín-Ruiz *et al.*, 2001). DOI increased the 5-HT release approximately threefold at 300 μ M. A higher concentration (500 μ M) resulted in an attenuated effect. The reasons for this bell-shaped concentration relationship are unclear, but may be related to the stimulation of 5-HT_{2A} receptors on

GABAergic interneurons at higher concentrations. Indeed, the application of DOI in PFC increased extracellular GABA (Abi-Saab *et al.*, 1999). However, the relationship to the present observations is unclear as dialysate GABA is unlikely to reflect synaptic release (Timmerman & Westerink, 1997; Bubser *et al.*, 1998). Given the *in vitro* nM affinity of DOI and M100907 for 5-HT_{2A} receptors, the concentrations used herein may appear nonselective. However, effective concentrations applied by reverse microdialysis to stimulate/block brain receptors or transporters differ typically by three–four orders of magnitude from *in vitro* affinities (see, e.g. Tao *et al.*, 2000; Hervás *et al.*, 2000; Sakai & Crochet, 2001; West *et al.*, 2002). This difference is mainly due to the low application rates used together with the continuous clearance of applied drugs via the brain capillaries and the CSF so that only a small fraction of the drug reaches the target receptors. As an example, the application of 100 μ M WAY-100635 (plus 100 nM [N-[2-(4-(2-methoxyphenyl)-1-piperazinyl)ethyl]-N-(2-pyridyl)cyclohexane carboxamide.3HCL] [³H]WAY-100635 used as a tracer) by reverse dialysis in the DR labelled only a small proportion of 5-HT_{1A} receptors in this nucleus (Celada *et al.*, 2001). This factor is particularly important in the present study as the effect of DOI on 5-HT release is indirect and involves the mPFC–DR circuit, i.e. DOI must stimulate a substantial population of 5-HT_{2A} receptors in projection neurons to the DR in order to elicit a measurable increase in terminal 5-HT release. The reversal by TTX precludes a direct releasing action (e.g. fenfluramine-like) on 5-HT nerve endings as this is TTX-insensitive (Carboni & Di Chiara, 1989).

Using *in vitro* intracellular and whole-cell recordings of layer V pyramidal neurons in prefrontal slices, Aghajanian, Marek and associates showed that the stimulation of 5-HT_{2A} receptors by 5-HT resulted in an increased excitability of the recorded cells, possibly as a result of an increased glutamate release from thalamocortical afferents (Aghajanian & Marek, 1997; Aghajanian & Marek, 1999; Aghajanian & Marek, 2000; Marek *et al.*, 2001). This effect is TTX-dependent and involves the activation of AMPA receptors, as observed for the stimulation of 5-HT release in rat and mouse mPFC (Martín-Ruiz *et al.*, 2001; this study). However, despite the fact that the stimulation of 5-HT release by DOI can be mimicked by thalamic stimulation/disinhibition and reversed by the mGluR II/III agonist 1S,3S-ACPD (Martín-Ruiz *et al.*, 2001; Puig *et al.*, 2003; this study), the effect of DOI on pyramidal cell firing and 5-HT release in rat mPFC does not depend on an excitatory thalamic input (Puig *et al.*, 2003). A plausible explanation for this apparent discrepancy between *in vitro* and *in vivo* effects of 5-HT_{2A} receptor stimulation is the loss of active glutamatergic inputs in the slice preparation.

Modulation of the effect of DOI by other receptors

As previously observed in rat mPFC (Martín-Ruiz *et al.*, 2001), the effect of DOI was reversed by the concurrent application of the selective 5-HT_{1A} receptor agonist BAY \times 3702 (De Vry *et al.*, 1998; Casanovas *et al.*, 1999; Casanovas *et al.*, 2000). The mPFC contains abundant 5-HT_{1A} receptors in pyramidal neurons (Pompeiano *et al.*, 1992; Kia *et al.*, 1996). Cortical 5-HT_{1A} and 5-HT_{2A} receptors are located postsynaptically to 5-HT axons (Blue *et al.*, 1988; Kia *et al.*, 1996), partly colocalize in cortical pyramidal neurons (Martín-Ruiz *et al.*, 2001) and have opposite effects on neuronal excitability (Araneda & Andrade, 1991; Ashby *et al.*, 1994). Recent findings indicate that the mRNAs of both receptors are coexpressed in a large proportion of prefrontal neurons (A. Bortolozzi, J. Serrats, G. Mengod & F. Artigas, unpublished observations). These observations suggest that DOI and BAY \times 3702 have opposite effects on 5-HT release in mPFC possibly through an increase and decrease, respectively, of the activity of descending excitatory pathways to midbrain 5-HT neurons

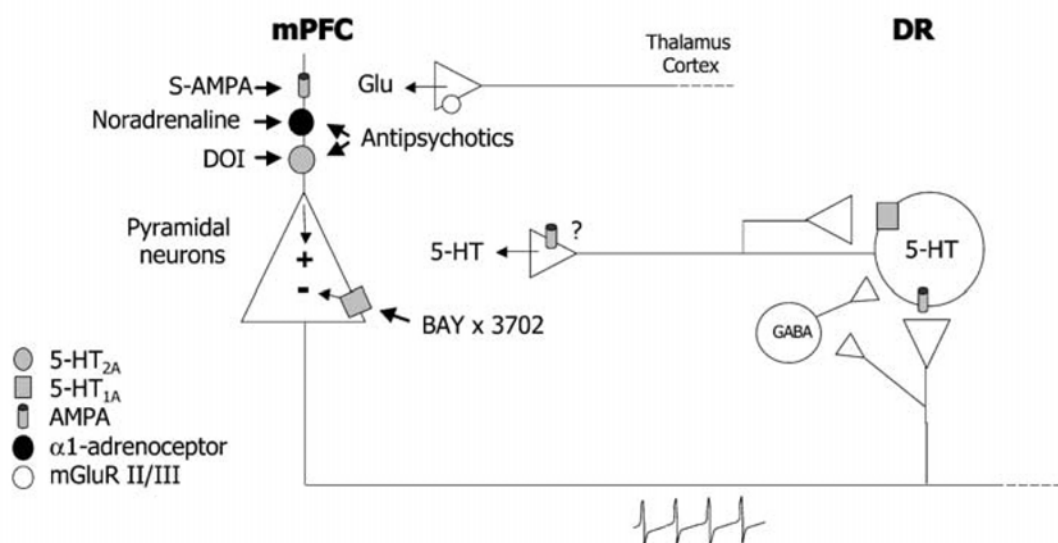

FIG. 12. Scheme of the interactions between the medial prefrontal cortex (mPFC) and midbrain 5-hydroxytryptamine (5-HT) neurons, with some of the receptors and neurotransmitters putatively involved in the action of 1-[2,5-dimethoxy-4-iodophenyl-2-aminopropane] (DOI) on 5-HT release. Previous anatomical and functional studies indicate the existence of a marked reciprocal connectivity between the mPFC and neurons in the midbrain raphe nuclei. A very large proportion of pyramidal neurons in the rat mPFC exhibit antidromic spikes after the electrical stimulation from the dorsal raphe nucleus (DR, Puig *et al.*, 2003), which additionally supports this connectivity. Pyramidal neurons express 5-HT_{2A} receptors and α_1 -adrenoceptors, whose activation by 5-HT and noradrenaline results in neuronal depolarization (Araneda & Andrade, 1991; Aghajanian & Marek, 1997). DOI increases (a) the firing rate of prefrontal pyramidal neurons, (b) the firing rate of 5-HT neurons, and (c) terminal 5-HT release. Likewise, the activation of pyramidal α -amino-3-hydroxy-5-methyl-4-isoxazole-4-propionate (AMPA) receptors produced by the local application of S-AMPA or by the disinhibition of thalamic afferents increases pyramidal cell firing and terminal 5-HT release in rat mPFC (Martín-Ruiz *et al.*, 2001; Puig *et al.*, 2003), although the latter effect might perhaps also involve AMPA receptors putatively located on 5-HT nerve terminals (see Discussion). The excitatory effect of DOI in mPFC is reversed by the activation of 5-HT_{1A} and mGlu I/III receptors, and by blockade of 5-HT_{2A} (but not 5-HT_{2C}), AMPA (but not NMDA) and α_1 -adrenoceptors. Antipsychotic drugs counteract the effect of DOI possibly by an action at α_1 -adrenoceptors (classical antipsychotics) and at α_1 -adrenoceptors plus 5-HT_{2A} receptors (atypical antipsychotics), thus reducing the activity of pyramidal cells and, hence, the increase in 5-HT release produced by DOI.

(Fig. 12). Likewise, BAY \times 3702 also reversed the increase in 5-HT release induced by the local application of S-AMPA, with a direct action on pyramidal AMPA receptors. A putative local (e.g. terminal) effect of AMPA receptor activation is suggested by release studies (Ohta *et al.*, 1994; Whitton *et al.*, 1994; Maione *et al.*, 1997; Tao *et al.*, 1997), but lacks anatomical support as GluR subunits, which constitute AMPA receptors, do not appear to be expressed in axon terminals (Petralia & Wenthold, 1992). However, a recent report (Shenk *et al.*, 2003) indicates that AMPA receptors can be targeted to presynaptic membranes upon neuronal depolarization in cell cultures. Should this occur *in vivo* in 5-HT axons, the effect of AMPA on 5-HT release might also be accounted for by a direct effect on 5-HT terminals. Notwithstanding this alternative interpretation, the reversal by BAY \times 3702 must necessarily involve postsynaptic 5-HT_{1A} receptors, as these are not present in nerve terminals (Kia *et al.*, 1996).

5-HT_{2A} receptors and α_1 -adrenoceptors share intracellular effector mechanisms (phospholipase C), and their activation depolarized (Araneda & Andrade, 1991) and increased the excitability of pyramidal neurons of the rat mPFC (Marek & Aghajanian, 1999). There is a marked overlap in the cortical distribution of both receptors in rat and mouse brain (Pazos *et al.*, 1985; Palacios *et al.*, 1987; Pieribone *et al.*, 1994; Pompeiano *et al.*, 1994; Day *et al.*, 1997; López-Giménez *et al.*, 2002) although, to our knowledge, there is no evidence of coexpression in prefrontal neurons. These observations suggest that the activation of 5-HT_{2A} and α_1 -adrenoceptors may have similar *in vivo* effects on prefrontal neurons. In parallel with the present neurochemical observations, both prazosin and haloperidol prevented DOI-induced headshakes, an effect possibly attributable to the ability of these agents to interact with α_1 -adrenoceptors (Schreiber *et al.*, 1995; Dursun & Handley, 1996). Prazosin lacks direct affinity for 5-HT_{2A} receptors

and therefore this effect must necessarily involve interactions at cellular or circuit level. For instance, as prazosin exhibits inverse agonist properties at cloned α_1 -adrenoceptors (Zhu *et al.*, 2000; Hein *et al.*, 2001), its application might counteract the increase in phospholipase C-linked intracellular messengers elicited by 5-HT_{2A} receptor activation. Furthermore, M100907 and prazosin reduced the basal 5-HT release and reversed the increase in prefrontal 5-HT release induced by the local application of the α_1 -adrenoceptor agonist cirazoline (M. Amargós-Bosch *et al.*, in press). This suggests a tonic role of both 5-HT_{2A} and α_1 -adrenoceptors on the control of prefrontal 5-HT release, possibly through the modulation of the activity of prefrontal neurons.

Modulation of the effect of DOI by antipsychotic drugs

Atypical antipsychotic drugs display high affinity for 5-HT_{2A} and α_1 -adrenoceptors, and block responses mediated by these receptors (Arnt & Skarsfeldt, 1998; Bymaster *et al.*, 1999a, b; Meltzer, 1999; Sebban *et al.*, 1999). Likewise, they display either direct 5-HT_{1A} agonist properties (e.g. ziprasidone, aripiprazole) or increase the 5-HT_{1A}-mediated neurotransmission through blockade of 5-HT_{2A} receptors (Ichikawa *et al.*, 2001). The atypical antipsychotic drugs clozapine and olanzapine antagonize 5-HT_{2A} and α_1 -adrenoceptors with high potency (Bymaster *et al.*, 1999a, b). Hence, both drugs likely reversed the DOI-stimulated 5-HT release by a blockade of its action on 5-HT_{2A} receptors. Blockade of α_1 -adrenoceptors may also be accountable, in view of the reversal of the effect of DOI by prazosin and the classical antipsychotics chlorpromazine and haloperidol. An additional effect of haloperidol (but not of chlorpromazine) on 5-HT_{2A} receptors cannot be fully excluded given its moderate affinity for this receptor. Thus, α_1 -adrenoceptor blockade may contribute to the therapeutic effects of

haloperidol and chlorpromazine (with nM affinity for α_1 -adrenoceptors) in a manner similar to that produced by 5-HT_{2A} receptor blockade, i.e. by reducing an increased excitability of prefrontal pyramidal neurons. This view is supported by the observation that α_1 -adrenoceptor blockade potentiates the antipsychotic effects of dopamine D2 antagonists (Wadenberg et al., 2000). Hence, it is interesting to note that these three activities of antipsychotic drugs (5-HT_{2A} and/or α_1 -adrenoceptor blockade, 5-HT_{1A} receptor activation) counteracted the effect of DOI on prefrontal 5-HT release. Because these receptors are expressed by prefrontal pyramidal neurons, we suggest that these are a common cellular target for the action of antipsychotic drugs, irrespectively of the initial pharmacological mechanism triggered.

In summary, DOI increases 5-HT release in mouse mPFC through the selective stimulation of local 5-HT_{2A} receptors. This effect is possibly due to a synergistic interaction with AMPA inputs in mPFC pyramidal (projection) neurons, which eventually translates into an increased activity of ascending 5-HT neurons and 5-HT release. This view is consistent with the antagonism of the DOI-induced effect on 5-HT release by mechanisms reducing pyramidal cell activity, such as the blockade of 5-HT_{2A}, α_1 -adrenoceptor or AMPA receptors as well as activation of 5-HT_{1A} and mGluR II/III receptors. However, an additional effect of S-AMPA on 5-HT release through terminal AMPA receptors cannot be excluded. The striking similarity between the affinity of atypical antipsychotic drugs for certain neurotransmitter receptors present in prefrontal pyramidal neurons and the reversal of the DOI-stimulated 5-HT release by ligands of these receptors suggests that this effect may be relevant for the therapeutic actions of antipsychotic drugs.

Acknowledgements

Work supported by grants from the Spanish Ministry of Science and Technology (SAF2001-2133) and Fundació La Marató TV3. Financial support from Eli Lilly is also acknowledged. The authors thank Leticia Campa for help in HPLC analyses and the pharmaceutical companies for generous drug supply. A.B. is the recipient of a postdoctoral fellowship from the Fundación Carolina. M.A.B., J.S. and L.D.M. are recipients of predoctoral fellowships from IDIBAPS.

Abbreviations

1S,3S-ACPD, (1S,3S-aminocyclopentane dicarboxylic acid); 5-HT, 5-hydroxytryptamine or serotonin; aCSF, artificial cerebrospinal fluid; ANOVA, analysis of variance; AMPA, α -amino-3-hydroxy-5-methyl-4-isoxazole-4-propionate; APTS, 3-aminopropyltriethoxysilane; BAY x 3702, {R(-)-2-[4-[(chroman-2-ylmethyl)-amino]-butyl]-1,1-dioxo-benzo[d]isothiazolone-HCl]; DOI, 1-[2,5-dimethoxy-4-iodophenyl]-2-aminopropane; DR, dorsal raphe nucleus; GABA, γ -aminobutyric acid; HPLC, high-performance liquid chromatography; i.p., intraperitoneally; KA, kainic acid; M100907, (R-+)- α -(2,3-dimethoxyphenyl)-1-[4-fluorophenylethyl]-4-piperidinemethanol; MK-801, dizocilpine; mPFC, medial prefrontal cortex; mRNA, messenger ribonucleic acid; NBQX, (2,3-dihydroxy-6-nitro-7-sulphamoyl-benzo(f)quinoxaline); NMDA, N-methyl-D-aspartate; PBS, phosphate-buffered saline; SB 242084, (6-chloro-5-methyl-1-[6-(2-methylpyridin-3-yloxy)pyridin-3-yl carbamoyl]indoline); SDS-PAGE, sodium dodecyl sulphate-polyacrylamide gel electrophoresis; TdT, terminal deoxynucleotidyltransferase; TTX, tetrodotoxin.

References

Abi-Saab, W.M., Bubser, M., Roth, R.H. & Deutch, A.Y. (1999) 5-HT₂ receptor regulation of extracellular GABA levels in the prefrontal cortex. *Neuropsychopharmacology*, **20**, 92–96.
 Adell, A. & Artigas, F. (1998) A microdialysis study of the in vivo release of 5-HT in the median raphe nucleus of the rat. *Br. J. Pharmacol.*, **125**, 1361–1367.
 Aghajanian, G.K. & Marek, G.J. (1997) Serotonin induces excitatory postsynaptic potentials in apical dendrites of neocortical pyramidal cells. *Neuropharmacology*, **36**, 589–599.

Aghajanian, G.K. & Marek, G.J. (1999) Serotonin, via 5-HT_{2A} receptors, increases EPSCs in layer v pyramidal cells of prefrontal cortex by an asynchronous mode of glutamate release. *Brain Res.*, **825**, 161–171.
 Aghajanian, G.K. & Marek, G.J. (2000) Serotonin model of schizophrenia: emerging role of glutamate mechanisms. *Brain Res. Rev.*, **31**, 302–312.
 Aghajanian, G.K. & Wang, R.Y. (1977) Habenular and other midbrain raphe afferents demonstrated by a modified retrograde tracing technique. *Brain Res.*, **122**, 229–242.
 Amargós-Bosch, M., Adell, A., Bortolozzi, A. & Artigas, F. (2003) Stimulation of α_1 -adrenoceptors in the rat medial prefrontal cortex increases the local in vivo 5-hydroxytryptamine release. Reversal by antipsychotic drugs. *J. Neurochem.* (in press).
 Andreasen, N.C., O'Leary, D.S., Flaum, M., Nopoulos, P., Watkins, G.L., Boles-Ponto, L.L. & Hichwa, R.D. (1997) Hypofrontality in schizophrenia: distributed dysfunctional circuits in neuroleptic-naïve patients. *Lancet*, **349**, 1730–1734.
 Aranea, R. & Andrade, R. (1991) 5-Hydroxytryptamine₂ and 5-hydroxytryptamine_{1A} receptors mediate opposing responses on membrane excitability in rat association cortex. *Neuroscience*, **40**, 399–412.
 Art, J. & Skarsfeldt, T. (1998) Do novel antipsychotics have similar pharmacological characteristics? A review of the evidence. *Neuropsychopharmacology*, **18**, 63–101.
 Ashby, C.R., Jiang, L.H., Kasser, R.J. & Wang, R.Y. (1990) Electrophysiological characterization of 5-hydroxytryptamine-2 receptors in the rat medial prefrontal cortex. *J. Pharmacol. Exp. Ther.*, **252**, 171–178.
 Ashby, C.R., Edwards, E. & Wang, R.Y. (1994) Electrophysiological evidence for a functional interaction between 5-HT(1A) and 5-HT(2A) receptors in the rat medial prefrontal cortex: An iontophoretic study. *Synapse*, **17**, 173–181.
 Au-Young, S.M., Shen, H. & Yang, C.R. (1999) Medial prefrontal cortical output neurons to the ventral tegmental area (VTA) and their responses to burst-patterned stimulation of the VTA: neuroanatomical and in vivo electrophysiological analyses. *Synapse*, **34**, 245–255.
 Barnes, N.M. & Sharp, T. (1999) A review of central 5-HT receptors and their function. *Neuropharmacology*, **38**, 1083–1152.
 Blue, M.E., Yagaloff, K.A., Mamounas, L.A., Hartig, P.R. & Molliver, M.E. (1988) Correspondence between 5-HT₂ receptors and serotonergic axons in rat neocortex. *Brain Res.*, **453**, 315–328.
 Bubser, M., de Brabander, J.M., Timmermann, W., Feenstra, M.G., Erdtsieck-Ernst, E.B., Rinkensm, A., van Uumm, J.F. & Westerink, B.H. (1998) Disinhibition of the mediodorsal thalamus induces fos-like immunoreactivity in both pyramidal and GABA-containing neurons in the medial prefrontal cortex of rats, but does not affect prefrontal extracellular GABA levels. *Synapse*, **30**, 156–165.
 Bymaster, F.P., Perry, W., Nelson, D.L., Wong, D.T., Rasmussen, K., Moore, N.A. & Calligaro, D.O. (1999a) Olanzapine: a basic science update. *Br. J. Psychiatry Supplement*, **36–40**.
 Bymaster, F.P., Nelson, D.L., De Lapp, N.W., Falcone, J.F., Eckol, S.K., Truex, L.L., Foreman, M.M., Lucaites, V.L. & Calligaro, D.O. (1999b) Antagonism by olanzapine of dopamine D₁, serotonin₂, muscarinic, histamine H₁ and alpha₁-adrenergic receptors in vitro. *Schizophr. Res.*, **37**, 107–122.
 Carboni, E. & Di Chiara, G. (1989) Serotonin release estimated by transcortical dialysis in freely-moving animals. *Neuroscience*, **32**, 637–645.
 Casanovas, J.M., Berton, O., Celada, P. & Artigas, F. (2000) In vivo actions of the selective 5-HT_{1A} receptor agonist BAY x 3702 on serotonergic cell firing and release. *Naunyn-Schmied. Arch. Pharmacol.*, **362**, 248–254.
 Casanovas, J.M., Hervás, I. & Artigas, F. (1999) Postsynaptic 5-HT_{1A} receptors control 5-HT release in the rat medial prefrontal cortex. *Neuroreport*, **10**, 1441–1445.
 Ceci, A., Baschiroto, A. & Borsini, F. (1994) The inhibitory effect of 8-OH-DPAT on the firing activity of dorsal raphe neurons in rats is attenuated by lesion of the frontal cortex. *Neuropharmacology*, **33**, 709–713.
 Celada, P., Puig, M.V., Casanovas, J.M., Guillazo, G. & Artigas, F. (2001) Control of dorsal raphe serotonergic neurons by the medial prefrontal cortex: involvement of serotonin-1A, GABA (A), and glutamate receptors. *J. Neurosci.*, **21**, 9917–9929.
 Cornea-Hebert, V., Riad, M., Wu, C., Singh, S.K. & Descarries, L. (1999) Cellular and subcellular distribution of the serotonin 5-HT_{2A} receptor in the central nervous system of adult rat. *J. Comp. Neurol.*, **409**, 187–209.
 Day, H.E., Campeau, S., Watson, S.J. Jr & Akil, H. (1997) Distribution of alpha 1a-, alpha 1b- and alpha 1d-adrenergic receptor mRNA in the rat brain and spinal cord. *J. Chem. Neuroanat.*, **13**, 115–139.
 De Vry, J., Schohe-Loop, R., Heine, H.G., Greuel, J.M., Mauler, F., Schmidt, B., Sommermeier, H. & Glaser, T. (1998) Characterization of the aminomethylchroman derivative BAY x 3702 as a highly potent 5-hydroxytryptamine (1A) receptor agonist. *J. Pharmacol. Exp. Ther.*, **284**, 1082–1094.

- Drevets, W.C., Price, J.L., Simpson, J.R., Todd, R.D., Reich, T., Vannier, M. & Raichle, M.E. (1997) Subgenual prefrontal cortex abnormalities in mood disorders. *Nature*, **386**, 824–827.
- Dursun, S.M. & Handley, S.L. (1996) Similarities in the pharmacology of spontaneous and DOI-induced head-shakes suggest 5HT_{2A} receptors are active under physiological conditions. *Psychopharmacology*, **128**, 198–205.
- Fay, R. & Kubin, L. (2000) Pontomedullary distribution of 5-HT_{2A} receptor-like protein in the rat. *J. Comp. Neurol.*, **418**, 323–345.
- Franklin, K.B.J. & Paxinos, G. (1997) *The Mouse Brain in Stereotaxic Coordinates*. Academic Press, Sydney.
- Fuster, J.M. (1997) *The Prefrontal Cortex. Anatomy, Physiology and Neuropsychology of the Frontal Lobe*. Lippincott-Raven, Philadelphia.
- Hajós, M., Hajos-Korcsok, E. & Sharp, T. (1999) Role of the medial prefrontal cortex in 5-HT_{1A} receptor-induced inhibition of 5-HT neuronal activity in the rat. *Br. J. Pharmacol.*, **126**, 1741–1750.
- Hajós, M., Richards, C.D., Szekely, A.D. & Sharp, T. (1998) An electrophysiological and neuroanatomical study of the medial prefrontal cortex projection to the midbrain raphe nuclei in the rat. *Neuroscience*, **87**, 95–108.
- Hein, P., Goepel, M., Cotecchia, S. & Michel, M.C. (2001) A quantitative analysis of antagonism and inverse agonism at wild-type and constitutively active hamster alpha_{1B}-adrenoceptors. *Naunyn-Schmiedeberg's Arch. Pharmacol.*, **363**, 34–39.
- Hervás, I., Queiroz, C.M., Adell, A. & Artigas, F. (2000) Role of uptake inhibition and autoreceptor activation in the control of 5-HT release in the frontal cortex and dorsal hippocampus of the rat. *Br. J. Pharmacol.*, **130**, 160–166.
- Ichikawa, J., Ishii, H., Bonaccorso, S., Fowler, W.L., O'Laughlin, I.A. & Meltzer, H.Y. (2001) 5-HT_{2A} and D-2 receptor blockade increases cortical DA release via 5-HT_{1A} receptor activation: a possible mechanism of atypical antipsychotic-induced cortical dopamine release. *J. Neurochem.*, **76**, 1521–1531.
- Jacobs, B.L. & Azmitia, E.C. (1992) Structure and function of the brain serotonin system. *Physiol. Rev.*, **72**, 165–229.
- Jakab, R.L. & Goldman-Rakic, P.S. (1998) 5-Hydroxytryptamine_{2A} serotonin receptors in the primate cerebral cortex: possible site of action of hallucinogenic and antipsychotic drugs in pyramidal cell apical dendrites. *Proc. Natl. Acad. Sci. USA*, **95**, 735–740.
- Jakab, R.L. & Goldman-Rakic, P.S. (2000) Segregation of serotonin 5-HT_{2A} and 5-HT₃ receptors in inhibitory circuits of the primate cerebral cortex. *J. Comp. Neurol.*, **417**, 337–348.
- Jodo, E., Chiang, C. & Aston-Jones, G. (1998) Potent excitatory influence of prefrontal cortex activity on noradrenergic locus coeruleus neurons. *Neuroscience*, **83**, 63–79.
- Kia, H.K., Brisorgueil, M.J., Hamon, M., Calas, A. & Vergé, D. (1996) Ultrastructural localization of 5-hydroxytryptamine_{1A} receptors in the rat brain. *J. Neurosci. Res.*, **46**, 697–708.
- Kroeze, W.K. & Roth, B.L. (1998) The molecular biology of serotonin receptors: therapeutic implications for the interface of mood and psychosis. *Biol. Psychiatry*, **44**, 1128–1142.
- López-Giménez, J.F., Tecott, L.H., Palacios, J.M., Mengod, G. & Vilaró, M.T. (2002) Serotonin 5-HT (2C) receptor knockout mice: autoradiographic analysis of multiple serotonin receptors. *J. Neurosci. Res.*, **67**, 69–85.
- Maione, S., Rossi, F., Biggs, C.S., Fowler, L.J. & Whittin, P.S. (1997) AMPA receptors modulate extracellular 5-hydroxytryptamine concentration and metabolism in rat striatum in vivo. *Neurochem. Int.*, **30**, 299–304.
- Marangell, L.B., Johnson, C.R., Kertz, B., Zboyan, H.A. & Martinez, J.M. (2002) Olanzapine in the treatment of apathy in previously depressed participants maintained with selective serotonin reuptake inhibitors: an open-label, flexible-dose study. *J. Clin. Psychiatry*, **63**, 391–395.
- Marek, G.J. & Aghajanian, G.K. (1999) 5-HT_{2A} receptor or alpha₁-adrenoceptor activation induces excitatory postsynaptic currents in layer V pyramidal cells of the medial prefrontal cortex. *Eur. J. Pharmacol.*, **367**, 197–206.
- Marek, G.J., Wright, R.A., Gewitz, J.C. & Schoepp, D.D. (2001) A major role for thalamocortical afferents in serotonergic hallucinogen receptor function in neocortex. *Neuroscience*, **105**, 379–392.
- Martín-Ruiz, R., Puig, M.V., Celada, P., Shapiro, D.A., Roth, B.L., Mengod, G. & Artigas, F. (2001) Control of serotonergic function in medial prefrontal cortex by serotonin-2A receptors through a glutamate-dependent mechanism. *J. Neurosci.*, **21**, 9856–9866.
- Meltzer, H.Y. (1999) The role of serotonin in antipsychotic drug action. *Neuropsychopharmacology*, **21**, S106–S115.
- Miner, L.A., Backstrom, J.R., Sanders-Bush, E. & Sesack, S.R. (2003) Ultrastructural localization of serotonin (2A) receptors in the middle layers of the rat prelimbic prefrontal cortex. *Neuroscience*, **116**, 107–117.
- Montgomery, S.A. (1994) Long-term treatment of depression. *Br. J. Psychiatry Supplement*, **26**, 31–36.
- Ohta, K., Fukuuchi, Y., Shimazu, K., Komatsumoto, S., Ichijo, M., Araki, N. & Shibata, M. (1994) Presynaptic glutamate receptors facilitate release of norepinephrine and 5-hydroxytryptamine as well as dopamine in the normal and ischemic striatum. *J. Auton. Nerv. Syst.*, **49**, S195–S202.
- Ostroff, R.B. & Nelson, J.C. (1999) Risperidone augmentation of selective serotonin reuptake inhibitors in major depression. *J. Clin. Psychiatry*, **60**, 256–259.
- Palacios, J.M., Hoyer, D. & Cortés, R. (1987) Alpha₁-adrenoceptors in the mammalian brain: similar pharmacology but different distribution in rodents and primates. *Brain Res.*, **419**, 65–75.
- Pazos, A., Cortés, R. & Palacios, J.M. (1985) Quantitative autoradiographic mapping of serotonin receptors in the rat brain. II. Serotonin-2 receptors. *Brain Res.*, **346**, 231–249.
- Petralia, R.S. & Wenthold, R.J. (1992) Light and electron immunocytochemical localization of AMPA-selective glutamate receptors in the rat brain. *J. Comp. Neurol.*, **318**, 329–354.
- Peyron, C., Petit, J.M., Rampon, C., Jouvet, M. & Luppi, P.H. (1998) Forebrain afferents to the rat dorsal raphe nucleus demonstrated by retrograde and anterograde tracing methods. *Neuroscience*, **82**, 443–468.
- Pieribone, V.A., Nicholas, A.P., Dagerlind, A. & Hökfelt, T. (1994) Distribution of alpha₁ adrenoceptors in rat brain revealed by in situ hybridization experiments utilizing subtype-specific probes. *J. Neurosci.*, **1**, 4252–4268.
- Pompeiano, M., Palacios, J.M. & Mengod, G. (1992) Distribution and cellular localization of mRNA coding for 5-HT_{1A} receptor in the rat brain: correlation with receptor binding. *J. Neurosci.*, **12**, 440–453.
- Pompeiano, M., Palacios, J.M. & Mengod, G. (1994) Distribution of the serotonin 5-HT₂ receptor family mRNAs: comparison between 5-HT_{2A} and 5-HT_{2C} receptors. *Mol. Brain Res.*, **23**, 163–178.
- Pons, S., Asano, T., Glasheen, E., Miralpeix, M., Zhang, Y., Fisher, T.L., Myers, M.G. Jr, Sun, X.J. & White, M.F. (1995) The structure and function of p55PIK reveal a new regulatory subunit for phosphatidylinositol 3-kinase. *Mol. Cell. Biol.*, **15**, 4453–4465.
- Pritchett, D.B., Bach, A.W., Wozny, M., Taleb, O., Dal Toso, R., Shih, J.C. & Seeburg, P.H. (1988) Structure and functional expression of cloned rat serotonin 5HT₂ receptor. *EMBO J.*, **7**, 4135–4140.
- Puig, M.V., Celada, P., Diaz-Mataix, L. & Artigas, F. (2003) In vivo modulation of the activity of pyramidal neurons in the rat medial prefrontal cortex by 5-HT_{2A} receptors. Relationship to thalamocortical afferents. *Cereb. Cortex*, **13**, 870–882.
- Sakai, K. & Crochet, S. (2001) Differentiation of presumed serotonergic dorsal raphe neurons in relation to behavior and wake-sleep states. *Neuroscience*, **104**, 1141–1155.
- Schenk, U., Verderio, C., Benfenati, F. & Matteoli, M. (2003) Regulated delivery of AMPA receptor subunits to the presynaptic membrane. *EMBO J.*, **22**, 558–568.
- Schreiber, R., Brocco, M., Audinot, V., Gobert, A., Veiga, S. & Millan, M.J. (1995) (1-(2,5-dimethoxy-4-iodophenyl)-2-aminopropane)-induced head-twitches in the rat are mediated by 5-hydroxytryptamine (5-HT)_{2A} receptors: modulation by novel 5-HT_{2A/2C} antagonists, D₁ antagonists and 5-HT_{1A} agonists. *J. Pharmacol. Exp. Ther.*, **273**, 101–112.
- Sebban, C., Tesolin-Decros, B., Millan, M.J. & Spedding, M. (1999) Contrasting EEG profiles elicited by antipsychotic agents in the prefrontal cortex of the conscious rat: antagonism of the effects of clozapine by modafinil. *Br. J. Pharmacol.*, **128**, 1055–1063.
- Sesack, S.R., Deutch, A.Y., Roth, R.H. & Bunney, B.S. (1989) Topographical organization of the efferent projections of the medial prefrontal cortex in the rat: an anterograde tract-tracing study with Phaseolus vulgaris leucoagglutinin. *J. Comp. Neurol.*, **290**, 213–242.
- Sesack, S.R. & Pickel, V.M. (1992) Prefrontal cortical efferents in the rat synapse on unlabeled neuronal targets of catecholamine terminals in the nucleus accumbens septi and on dopamine neurons in the ventral tegmental area. *J. Comp. Neurol.*, **320**, 145–160.
- Shelton, R.C., Tollefson, G.D., Tohen, M., Stahl, S., Gannon, K.S., Jacobs, T.G., Buras, W.R., Bymaster, F.P., Zhang, W., Spencer, K.A., Feldman, P.D. & Meltzer, H.Y. (2001) A novel augmentation strategy for treating resistant major depression. *Am. J. Psychiatry*, **158**, 131–134.
- Takagishi, M. & Chiba, T. (1991) Efferent projections of the infralimbic (area 25) region of the medial prefrontal cortex in the rat: an anterograde tracer PHA-L study. *Brain Res.*, **566**, 26–39.
- Tao, R., Ma, Z. & Auerbach, S.B. (1997) Influence of AMPA/kainate receptors on extracellular 5-hydroxytryptamine in rat midbrain raphe and forebrain. *Br. J. Pharmacol.*, **121**, 1707–1715.
- Tao, R., Ma, Z.Y. & Auerbach, S.B. (2000) Differential effect of local infusion of serotonin reuptake inhibitors in the raphe versus forebrain and the role of depolarization-induced release in increased extracellular serotonin. *J. Pharmacol. Exp. Ther.*, **294**, 571–579.

- Thierry, A.M., Deniau, J.M., Chevalier, G., Ferron, A. & Glowinski, J. (1983) An electrophysiological analysis of some afferent and efferent pathways of the rat prefrontal cortex. *Prog. Brain Res.*, **58**, 257–261.
- Timmerman, W. & Westerink, B.H.C. (1997) Brain microdialysis of GABA and glutamate: What does it signify? *Synapse*, **2**, 242–261.
- Titeler, M., Lyon, R.A. & Glennon, R.A. (1988) Radioligand binding evidence implicates the brain 5-HT₂ receptor as a site of action for LSD and phenylisopropylamine hallucinogens. *Psychopharmacology*, **94**, 213–216.
- Tomiyama, M., Palacios, J.M., Cortés, R., Vilaró, M. & Mengod, G. (1997) Distribution of AMPA receptor subunit mRNAs in the human basal ganglia: an in situ hybridization study. *Mol. Brain Res.*, **46**, 281–289.
- Varga, V., Szekely, A.D., Csillag, A., Sharp, T. & Hajós, M. (2001) Evidence for a role of GABA interneurons in the cortical modulation of midbrain 5-hydroxytryptamine neurons. *Neuroscience*, **106**, 783–792.
- Wadenberg, M.L., Hertel, P., Fernholm, R., Hygge Blakeman, K., Ahlenius, S. & Svensson, T.H. (2000) Enhancement of antipsychotic-like effects by combined treatment with the alpha₁-adrenoceptor antagonist prazosin and the dopamine D2 receptor antagonist raclopride in rats. *J. Neural Transm.*, **107**, 1229–1238.
- West, A.R., Moore, H. & Grace, A.A. (2002) Direct examination of local regulation of membrane activity in striatal and prefrontal cortical neurons in vivo using simultaneous intracellular recording and microdialysis. *J. Pharmacol. Exp. Ther.*, **301**, 867–877.
- Whitton, P.S., Maione, S., Biggs, C.S. & Fowler, L.J. (1994) Tonic desensitization of hippocampal alpha-amino-3-hydroxy-5-methyl-4-isoxazolepropionic acid receptors regulates 5-hydroxytryptamine release in vivo. *Neuroscience*, **63**, 945–948.
- Williams, G.V., Rao, S.G. & Goldman-Rakic, P.S. (2002) The physiological role of 5-HT_{2A} receptors in working memory. *J. Neurosci.*, **22**, 2843–2854.
- Willins, D.L., Deutch, A.Y. & Roth, B.L. (1997) Serotonin 5HT_{2A} receptors are expressed on pyramidal neurons and interneurons in the rat cortex. *Synapse*, **27**, 79–82.
- Zhou, F.M. & Hablitz, J.J. (1999) Activation of serotonin receptors modulates synaptic transmission in rat cerebral cortex. *J. Neurophysiol.*, **82**, 2989–2999.
- Zhu, J., Taniguchi, T., Takauji, R., Suzuki, F., Tanaka, T. & Muramatsu, I. (2000) Inverse agonism and neutral antagonism at a constitutively active alpha-1A adrenoceptor. *Br. J. Pharmacol.*, **131**, 546–552.